

US EPA ARCHIVE DOCUMENT

Environmental Technology Verification Report

Residential Electric Power
Generation Using the Plug Power
SU1 Fuel Cell System

Prepared by:



**Greenhouse Gas Technology Center
Southern Research Institute**



Under a Cooperative Agreement With
U.S. Environmental Protection Agency

and



Under Agreement With
New York State Energy Research and Development Authority



EPA REVIEW NOTICE

This report has been peer and administratively reviewed by the U.S. Environmental Protection Agency, and approved for publication. Mention of trade names or commercial products does not constitute endorsement or recommendation for use.

THE ENVIRONMENTAL TECHNOLOGY VERIFICATION PROGRAM



ETV Joint Verification Statement

TECHNOLOGY TYPE:	Proton Exchange Membrane Fuel Cell
APPLICATION:	Distributed Electrical Power Generation
TECHNOLOGY NAME:	Plug Power SU1 Fuel Cell System
COMPANY:	Plug Power
ADDRESS:	968 Albany-Shaker Road, Latham, NY 12110
E-MAIL:	David_Rollins@plugpower.com

The U.S. Environmental Protection Agency (EPA) has created the Environmental Technology Verification (ETV) program to facilitate the deployment of innovative or improved environmental technologies through performance verification and dissemination of information. The goal of the ETV program is to further environmental protection by accelerating the acceptance and use of improved and cost-effective technologies. ETV seeks to achieve this goal by providing high-quality, peer-reviewed data on technology performance to those involved in the purchase, design, distribution, financing, permitting, and use of environmental technologies.

ETV works in partnership with recognized standards and testing organizations, stakeholder groups that consist of buyers, vendor organizations, and permittees, and with the full participation of individual technology developers. The program evaluates the performance of technologies by developing test plans that are responsive to the needs of stakeholders, conducting field or laboratory tests, collecting and analyzing data, and preparing peer-reviewed reports. All evaluations are conducted in accordance with rigorous quality assurance protocols to ensure that data of known and adequate quality are generated and that the results are defensible.

The Greenhouse Gas Technology Center (GHG Center), one of six verification organizations under the ETV program, is operated by Southern Research Institute (SRI) in cooperation with EPA's National Risk Management Research Laboratory. The GHG Center has collaborated with the New York State Energy and Development Authority (NYSERDA) to evaluate the performance of the Stationary Unit 1

Demonstration Fuel Cell System (SU1 system) offered by Plug Power. This verification statement provides a summary of the test results for the SU1 system.

TECHNOLOGY DESCRIPTION

The following description of the SU1 system was provided by the vendor and does not represent verified information. The Plug Power SU1 is one of the first commercially available proton exchange membrane (PEM) fuel cell systems. The unit is designed to generate nominal 5 kW of electricity through a reaction between hydrogen (H₂), oxygen (O₂), and a solid electrolyte (the proton exchange membrane). This type of fuel cell operates at relatively low temperatures (about 175 °F) and can vary output fairly quickly to meet changes in demand. The basic principle of operation is to convert H₂ into electrical energy with an electrochemical reaction with O₂, generally supplied from ambient air.

Because pure H₂ is usually not readily available, a reformed fuel (reformate) rich in H₂ is derived from fuels such as natural gas, propane, methanol, or other petroleum products using a fuel processor. The SU1 system uses auto-thermal reforming (ATR) technology to generate reformate. The reformate created by fuel processing consists primarily of hydrogen (H₂), carbon dioxide (CO₂), nitrogen (N₂), and carbon monoxide (CO). The fuel processor also contains a CO cleanup component to remove or transform all or most of the CO to CO₂ and minimize CO damage to the system.

Direct current (DC) electricity is generated in the SU1 fuel cell stack. The stack consists of a series of electrodes (an anode and cathode) separated by an ion-exchange membrane. The reformate is directed into the anode and air enters the system through the cathode during operation. The H₂ molecules in the reformate split into two protons and two electrons. The electrons flow through an external circuit creating a low-voltage direct electrical current (DC). The H⁺ protons pass through the membrane and combine at the cathode with the electrons and O₂ from the air to form water, with waste heat as a by-product.

The SU1 also includes a power conditioner. This component uses an inverter to convert the low-voltage DC produced by the stack to alternating current (AC) power and a transformer to produce the desired voltage output. Specific power-conditioning transformers are unit-specific and vary depending on the size and generating capacity of the fuel cell. The SU1 system is equipped with 4 lead-acid batteries to provide auxiliary power during extended periods of peak demand that are higher than fuel cell output capacity, and to aid in starting the SU1 system.

VERIFICATION DESCRIPTION

Verification of the SU1 was conducted at a private residence in Lewiston, New York. The home is located in Niagara County, New York and includes 2,060 ft² of conventional living space and 700 ft² of basement space. The home was constructed in the early 1970's, and contains walls that are insulated at a typical R-11 level and ceilings that are R-19 rated. Natural gas is used to fuel the SU1, and space heating at the home is provided by a gas-fired boiler. In addition to standard electrical outlets and lighting fixtures throughout the home, it contains a hot tub, electrical washer, and gas dryer (dryer motor is electric), several ceiling fan/light units, a refrigerator, dishwasher, microwave, several television sets, computer, sump pump, freezer, and other miscellaneous electrical devices.

The SU1 fuel cell is not a load-following system, but is configured to operate at nominal power outputs of 2.5, 4.0, or 5.0 kW. Under the fuel cell interconnect contract with the local utility, all power generated by the fuel cell and not used by the residence is directed to the grid. Therefore, the system is normally set to

operate at 2.5 kW. If the power demand exceeds the available capacity of the fuel cell, additional power is drawn from the grid. In the event of a grid power failure, the system is designed to automatically shut down, to isolate system from grid faults. When grid power is restored, the SU1 system can be restarted manually.

Testing commenced on April 10, 2003, and was completed on April 21, 2003. It consisted of a series of short periods of “controlled tests” in which the unit was operated at power output commands of 5, 4, and 2.5 kW respectively. Three test replicates were conducted at each power output command to determine power output, electrical efficiency, power quality, and emissions performance. These controlled test periods were followed by approximately 10 days of extended monitoring to verify electric power production and power quality performance during a period of normal site operations.

The classes of verification parameters evaluated are:

- **Power Production Performance**
- **Emissions Performance**
- **Power Quality Performance**

Evaluation of power production performance includes verification of power output and electrical efficiency. Electrical efficiency was determined according to the ASME Performance Test Code for Fuel Cell Power Systems (ASME PTC-50), and tests consisted of direct measurements of fuel flow rate, fuel heating value, and power output. Ambient temperature, barometric pressure, and relative humidity measurements were also collected to characterize the condition of the air used by the fuel cell.

The evaluation of emissions performance occurred simultaneously with efficiency determination at all power output settings. Pollutant concentration and emission rate measurements for nitrogen oxides (NO_x), carbon monoxide (CO), total hydrocarbons (THC), carbon dioxide (CO₂), and methane (CH₄) were conducted in the SU1 exhaust stack. All emissions test procedures used in the verification were U.S. EPA Federal Reference Methods. Pollutant concentrations in the exhaust gas are reported in two sets of units: (1) parts per million volume, dry (ppmvd) corrected to 15 percent O₂, and (2) mass per unit time (lb/hr). The mass emission rates are also normalized to power output and reported as pounds per kilowatt hour (lb/kWh).

Annual NO_x and CO₂ emissions reductions for the SU1 system at the test site are estimated by comparing measured lb/kWh emission rates with corresponding emission rates for the baseline power production systems (i.e., systems that would be used if the SU1 system were not present). The baseline system at this site is electricity supplied from the local utility grid (Niagara Mohawk). Baseline emissions for the electrical power were determined following Ozone Transport Commission guidelines.

Electrical power quality parameters, such as electrical frequency and voltage output, were also measured during the ten-day extended test. Other performance parameters, including current and voltage total harmonic distortions (THD) and power factor, were monitored to characterize the quality of electricity supplied to the end user. The guidelines listed in the Institute of Electrical and Electronics Engineers’ Recommended Practices and Requirements for Harmonic Control in Electrical Power Systems were used to perform power quality testing.

Quality Assurance (QA) oversight of verification testing was provided following specifications in the ETV Quality Management Plan (QMP). GHG Center staff conducted one performance evaluation audit and an audit of data quality on at least 10 percent of the data generated during this verification.

VERIFICATION OF PERFORMANCE

Power Production Performance

- All controlled tests occurred at similar operating conditions (ambient temperatures 40 to 50 °F; barometric pressure: 14.39 to 14.58 psia; relative humidity: 52 to 69 percent).
- The following table shows the heat input, power output, heat rate, and efficiency of the SU1 at the three loads tested.

SU1 Power Production				
Power Command (kW)	Power Delivered (kW)	Heat Input (MBtu/hr)	Heat Rate (MBtu/kWh)	Electrical Efficiency (%)
5	4.75	68.05	14.33	23.8
4	3.91	53.90	13.78	24.7
2.5	2.57	35.84	13.94	24.5

- The SU1 generated 689 kWh electricity over an extended monitoring period of 233.5 hours. SU1 power output varied between nominal 2.5 and 5.0 kW as commanded by the system operator, but was stable at both set-points. A total of 61 hours of downtime were experienced during this period equating to a system availability of about 74 percent. The average generating rate during this period was 2.95 kW, including periods of downtime.

Emissions Performance

The following table summarizes the measured pollutant concentrations and emissions rates for the SU1 System at each of the three power outputs tested.

Criteria Pollutant And GHG Emissions									
Power Output (kW)	(ppmvd at 15% O₂)				(lb/kWh_e)				
	NO_x	CO	THC	CH₄	NO_x	CO	THC	CH₄	CO₂
4.75	<0.035	0.13	476	465	<1.64 x 10 ⁻⁶	4.18 x 10 ⁻⁶	0.0087	0.0085	1.66
3.91	<0.020	0.10	488	485	<6.97 x 10 ⁻⁷	3.07 x 10 ⁻⁶	0.0086	0.0086	1.61
2.57	<0.025	0.19	509	492	<1.27 x 10 ⁻⁶	6.04 x 10 ⁻⁶	0.0091	0.0088	1.61

- NO_x concentrations were at or near the sensitivity limits of the sampling system during all testing. CO emissions were also very low during all test periods.
- Emissions of CO₂ averaged 1.63 lb/kWh over the fuel cell's range of power output.
- Emissions of CH₄ and THC were consistent at the three power outputs and average 0.0087 and 0.0088 lb/kWh, respectively.

- During normal fuel cell operations at the residence (power set-point of 2.5 kW), NO_x emissions per unit electrical power output were 1.27×10^{-6} lb/kWh, well below the average levels reported for the regional grid (0.0024 lb/kWh) by the Ozone Transport Commission (OTC). This resulted in an estimated annual NO_x emission reduction of 44.3 lbs (64 percent).
- This version of the SU1 (without heat recovery potential) is essentially a greenhouse gas neutral technology. The average CO₂ emissions for the regional grid are estimated at 1.53 lb/kWh which is slightly lower than the emission rate for the SU1 (1.61 lb/kWh), but since the SU1 eliminates the estimated 7.8 percent line losses associated with grid power, an average annual CO₂ emission reduction of 723 lbs (1.7 percent) is estimated. But these CO₂ reductions are likely offset by the level of methane emissions from the SU1, which are higher than the typical combustion generators at central power plants.

Power Quality Performance

- Throughout the ten-day test period, the SU1 system maintained synchronization with the utility grid during all operational periods. Average electrical frequency was 60.001 Hz and average voltage output was 120.98 volts.
- The power factor remained relatively constant for all monitoring days with an average of 99.9 percent and a range of 99.6 to 100.0 percent.
- The average current total harmonic distortion (THD) was 2.85 percent, and the average voltage THD was 2.69 percent, both well below the ± 5 percent threshold specified in IEEE 519.

Details on the verification test design, measurement test procedures, and Quality Assurance/Quality Control (QA/QC) procedures can be found in the Test Plan titled *Test and Quality Assurance Plan for Residential Electric Power Generation Using the Plug Power SU1 Fuel Cell System* (SRI 2003). Detailed results of the verification are presented in the Final Report titled *Environmental Technology Verification Report for Residential Electric Power Generation Using the Plug Power SU1 Fuel Cell System* (SRI 2003). Both can be downloaded from the GHG Center's Web site (www.sri-rtp.com) or the ETV Program web site (www.epa.gov/etv).

Signed by: Hugh W. McKinnon, 9-2003

Hugh W. McKinnon, M.D., M.P.H.
Director
National Risk Management Research Laboratory
Office of Research and Development

Signed by: Stephen D. Piccot, 9-2003

Stephen D. Piccot
Director
Greenhouse Gas Technology Center
Southern Research Institute

Notice: GHG Center verifications are based on an evaluation of technology performance under specific, predetermined criteria and the appropriate quality assurance procedures. The EPA and Southern Research Institute make no expressed or implied warranties as to the performance of the technology and do not certify that a technology will always operate at the levels verified. The end user is solely responsible for complying with any and all applicable Federal, State, and Local requirements. Mention of commercial product names does not imply endorsement or recommendation.

EPA REVIEW NOTICE

This report has been peer and administratively reviewed by the U.S. Environmental Protection Agency, and approved for publication. Mention of trade names or commercial products does not constitute endorsement or recommendation for use.

Greenhouse Gas Technology Center
A U.S. EPA Sponsored Environmental Technology Verification (ETV) Organization



Environmental Technology Verification Report

**Residential Electric Power Generation Using the Plug Power SU1
Fuel Cell System**

Prepared By:

Greenhouse Gas Technology Center
Southern Research Institute
PO Box 13825
Research Triangle Park, NC 27709 USA
Telephone: 919/806-3456

Under EPA Cooperative Agreement CR 826311-01-0
and NYSERDA Agreement 7009

U.S. Environmental Protection Agency
Office of Research and Development
National Risk Management Research Laboratory
Air Pollution Prevention and Control Division
Research Triangle Park, NC 27711 USA

EPA Project Officer: David A. Kirchgessner
NYSERDA Project Officer: Richard Drake

TABLE OF CONTENTS

	<u>Page</u>
APPENDICES	iii
LIST OF FIGURES	iii
LIST OF TABLES	iii
ACKNOWLEDGMENTS	iv
ACRONYMS/ABBREVIATIONS	v
1.0 INTRODUCTION	1-1
1.1. BACKGROUND.....	1-1
1.2. SU1 SYSTEM TECHNOLOGY DESCRIPTION.....	1-2
1.3. TEST FACILITY DESCRIPTION.....	1-4
1.4. PERFORMANCE VERIFICATION OVERVIEW.....	1-5
1.4.1. Power Production Performance.....	1-7
1.4.2. Measurement Equipment.....	1-8
1.4.3. Power Quality Performance.....	1-10
1.4.4. Emissions Performance.....	1-11
1.4.5. Estimated Annual Emission Reductions for the Lewiston Residence.....	1-14
2.0 VERIFICATION RESULTS	2-1
2.1 POWER PRODUCTION PERFORMANCE.....	2-2
2.1.1 Electrical Power Output and Efficiency During Controlled Tests.....	2-2
2.1.2 Electrical Energy Production Over the Extended Test.....	2-4
2.2 POWER QUALITY PERFORMANCE.....	2-6
2.2.1 Electrical Frequency.....	2-6
2.2.2 Voltage Output.....	2-7
2.2.3 Power Factor.....	2-9
2.2.4 Current and Voltage Total Harmonic Distortion.....	2-10
2.3 EMISSIONS PERFORMANCE.....	2-11
2.3.1 SU1 System Stack Exhaust Emissions.....	2-11
2.3.2 Estimation of Annual Emission Reductions for the Lewiston Residence.....	2-14
3.0 DATA QUALITY ASSESSMENT	3-1
3.1 DATA QUALITY OBJECTIVES.....	3-1
3.2 RECONCILIATION OF DQOs AND DQIs.....	3-2
3.2.1 Power Output.....	3-5
3.2.2 Electrical Efficiency.....	3-6
3.2.2.1 PTC-50 Requirements for Electrical Efficiency Determination.....	3-7
3.2.2.2 Ambient Measurements.....	3-8
3.2.2.3 Fuel Lower Heating Value.....	3-8
3.2.3 Exhaust Stack Emission Measurements.....	3-9
4.0 REFERENCES	4-1

APPENDICES

		<u>Page</u>
APPENDIX A	Emissions Testing QA/QC Results	A-1
APPENDIX B	Estimation of Regional Grid Emissions	B-1

LIST OF FIGURES

		<u>Page</u>
Figure 1-1	The SU1 System Process Diagram	1-3
Figure 1-2	The SU1 System at the Lewiston Residence.....	1-5
Figure 1-3	Schematic of Measurement System	1-8
Figure 2-1	Power Output and Efficiency During Controlled Test Periods.....	2-3
Figure 2-2	Power Production During the Extended Test Period	2-4
Figure 2-3	Effects of Ambient Temperature on SU1 Power Production	2-5
Figure 2-4	Effects of Ambient Temperature on SU1 Efficiency	2-6
Figure 2-5	SU1 System Electrical Frequency During Extended Test Period.....	2-7
Figure 2-6	SU1 System Voltage Output During Extended Test Period	2-8
Figure 2-7	SU1 System Power Factors During Extended Test Period	2-9
Figure 2-8	SU1 System Current and Voltage THD During Extended Test Period	2-10

LIST OF TABLES

		<u>Page</u>
Table 1-1	The Plug Power SU1 System Specifications	1-4
Table 1-2	Controlled and Extended Test Periods.....	1-6
Table 1-3	Summary of Emissions Testing Methods	1-12
Table 1-4	Electrical Demand for the Lewiston Residence During 2002.....	1-15
Table 2-1	Power Production Performance During Controlled Test Periods	2-2
Table 2-2	SU1 Fuel Input During Controlled Test Periods.....	2-3
Table 2-3	SU1 Electrical Frequency During Extended Period.....	2-7
Table 2-4	SU1 Voltage During Extended Period	2-8
Table 2-5	SU1 Power Factors During Extended Period.....	2-9
Table 2-6	SU1 THDs During Extended Period.....	2-10
Table 2-7	SU1 Emissions During Controlled Periods.....	2-13
Table 2-8	Emissions Offsets From On-Site Electricity Production.....	2-15
Table 3-1	Verification Parameter Data Quality Objectives.....	3-1
Table 3-2	Summary of Data Quality Goals and Results	3-3
Table 3-3	Results of Additional QA/QC Checks	3-6
Table 3-4	Electrical Efficiency Error Propagation.....	3-7
Table 3-5	Variability Observed in Operating Conditions	3-8
Table 3-6	Results of Natural Gas Audit Sample Analysis	3-9
Table 3-7	Additional QA/QC Checks for Emissions Testing	3-11

ACKNOWLEDGMENTS

The Greenhouse Gas Technology Center wishes to thank the New York State Energy Research and Development Authority (NYSERDA), especially Richard Drake and James Foster, for reviewing and providing input on the testing strategy and this Verification Report. Thanks are also extended to Joseph Siegrist of ATSI Engineering Services for hosting the verification at his private residence, and his valuable assistance in executing the verification testing.

ACRONYMS/ABBREVIATIONS

Abs. Diff.	absolute difference
AC	alternating current
acf	actual cubic feet
ADER	average displaced emission rate
ADQ	Audit of Data Quality
Amp	amperes
ANSI	American National Standards Institute
APPCD	Air Pollution Prevention and Control Division
ASME	American Society of Mechanical Engineers
Btu	British thermal units
Btu/hr	British thermal units per hour
Btu/lb	British thermal units per pound
Btu/min	British thermal units per minute
Btu/scf	British thermal units per standard cubic feet
C1	quantification of methane
CH ₄	methane
CHP	combined heat and power
CO	carbon monoxide
CO ₂	carbon dioxide
CT	current transformer
DAS	data acquisition system
DG	distributed generation
DMM	digital multimeter
DOE	U.S. Department of Energy
DP	differential pressure
DQI	data quality indicator
DQO	data quality objective
EPA	Environmental Protection Agency
ETV	Environmental Technology Verification
°C	degrees Celsius
°F	degrees Fahrenheit
FERC	Federal Energy Regulatory Commission
FID	flame ionization detector
fps	feet per second
ft ³	cubic feet
gal	U.S. Imperial gallons
GC	gas chromatograph
GHG Center	Greenhouse Gas Technology Center
GU	generating unit
HHV	higher heating value
hr	hours
Hz	hertz
IEEE	Institute of Electrical and Electronics Engineers
ISO	International Standards Organization or Independent System Operator

ACRONYMS/ABBREVIATIONS

Kva	kilovolt-amperes
kVAr	kilovolt reactive
Kw	kilowatts
kWh	kilowatt hours
kWh _e	kilowatt hours electrical
kWh/yr	kilowatt hours per year
lb	pounds
lb/Btu	pounds per British thermal unit
lb/dscf	pounds per dry standard cubic foot
lb/ft ³	pounds per cubic feet
lb/hr	pounds per hour
lb/kWh	pounds per kilowatt-hour
lb/yr	pounds per year
LHV	lower heating value
Mbtu/hr	thousand British thermal units per hour
MMBtu/hr	million British thermal units per hour
MMcf	million cubic feet
mol	molecular
N ₂	nitrogen
NDIR	non-dispersive infrared
NIST	National Institute of Standards and Technology
NO	nitrogen oxide
NO ₂	nitrogen dioxide
NO _x	nitrogen oxides
NSPS	New Source Performance Standards
NY ISO	New York Independent System Operator
NYSERDA	New York State Energy Research and Development Authority
O ₂	oxygen
O ₃	ozone
ORD	Office of Research and Development
OTC	Ozone Transport Commission
PEA	Performance Evaluation Audit
PEM	Proton exchange membrane
ppbv	parts per billion volume
ppbvd	parts per billion volume dry
ppmv	parts per million volume
ppmvd	parts per million volume dry
psia	pounds per square inch absolute
psig	pounds per square inch gauge
PTC	Performance Test Code
QA/QC	Quality Assurance/Quality Control
QMP	Quality Management Plan
Rel. Diff.	relative difference
Report	Environmental Technology Verification Report
RH	relative humidity

ACRONYMS/ABBREVIATIONS

rms	root mean square
RTD	resistance temperature detector
scf	standard cubic feet
scfh	standard cubic feet per hour
scfm	standard cubic feet per minute
SRI	Southern Research Institute
SU1	Plug Power Stationary Unit 1 PEM Fuel Cell
T&D	transmission and distribution
TEI	Thermo Environmental Instruments
Test Plan	Test and Quality Assurance Plan
THCs	total hydrocarbons
THD	total harmonic distortion
U.S.	United States
VAC	volts alternating current

PAGE INTENTIONALLY LEFT BLANK

1.0 INTRODUCTION

1.1. BACKGROUND

The U.S. Environmental Protection Agency's Office of Research and Development (EPA-ORD) operates the Environmental Technology Verification (ETV) program to facilitate the deployment of innovative technologies through performance verification and information dissemination. The goal of ETV is to further environmental protection by substantially accelerating the acceptance and use of improved and innovative environmental technologies. Congress funds ETV in response to the belief that there are many viable environmental technologies that are not being used for the lack of credible third-party performance data. With performance data developed under this program, technology buyers, financiers, and permittees in the United States and abroad will be better equipped to make informed decisions regarding environmental technology purchase and use.

The Greenhouse Gas Technology Center (GHG Center) is one of six verification organizations operating under the ETV program. The GHG Center is managed by EPA's partner verification organization, Southern Research Institute (SRI), which conducts verification testing of promising GHG mitigation and monitoring technologies. The GHG Center's verification process consists of developing verification protocols, conducting field tests, collecting and interpreting field and other data, obtaining independent peer-review input, and reporting findings. Performance evaluations are conducted according to externally reviewed verification Test and Quality Assurance Plans (Test Plan) and established protocols for quality assurance.

The GHG Center is guided by volunteer groups of stakeholders. These stakeholders guide the center on which technologies are most appropriate for testing, help disseminate results, and review Test Plans and Technology Verification Reports (report). The GHG Center's Executive Stakeholder Group consists of national and international experts in the areas of climate science and environmental policy, technology, and regulation. It also includes industry trade organizations, environmental technology finance groups, governmental organizations, and other interested groups. The GHG Center's activities are also guided by industry specific stakeholders who provide guidance on the verification testing strategy related to their area of expertise and peer-review key documents prepared by the GHG Center.

Distributed electrical power generation is a technology area of interest to some GHG Center stakeholders. Distributed generation (DG) refers to electricity generation equipment, typically ranging in size from 5 to 1,000 kilowatts (kW), that provides electric power at a customer's site (as opposed to central station generation). A DG unit can be connected directly to the customer and/or to a utility's transmission and distribution (T&D) system. Examples of technologies available for DG include gas turbine generators, internal combustion (IC) engine generators (gas, diesel, other), photovoltaics, wind turbines, fuel cells, and microturbines. DG technologies provide customers one or more of the following main services: standby generation (i.e., emergency backup power), peak-shaving generation (during high-demand periods), base-load generation (constant generation), or cogeneration (combined heat and power generation).

The GHG Center and the New York State Energy Research and Development Authority (NYSERDA) agreed in early 2002 to collaborate and share the cost of verifying several new DG technologies operating throughout the state of New York under NYSERDA-sponsored programs. This verification evaluated the performance of the Plug Power Stationary Unit 1 Fuel Cell Demonstration System (SU1 system) commercially offered as a technology demonstrator by Plug Power of Latham, New York. The SU1

system is a Proton Exchange Membrane (PEM) fuel cell capable of producing 5 kW of electrical power in a residential setting. Using pipeline natural gas available at many residences, the SU1 system contains a reformer that converts natural gas into hydrogen (H₂), allowing electricity to be generated by the SU1 system through a relatively low-temperature electrochemical reaction between H₂, oxygen (O₂), and a solid electrolyte (the proton exchange membrane). Because the reforming process also produces carbon monoxide (CO), a poison to proton exchange membranes, the fuel processor also contains a CO cleanup step to remove CO or transform it into carbon dioxide (CO₂). PEM fuel cell capacities generally range between 5 and 250kW, and electrical conversion efficiencies can vary from about 25 to 40 percent.

The GHG Center evaluated the performance of an SU1 system installed at a private residence in Lewiston, NY. Performance was evaluated by conducting field tests over an eleven-day verification period (April 10 through 21, 2003). These tests were planned and executed by the GHG Center to independently verify the electricity generation and use rate, electrical power quality, electrical efficiency, emissions, and greenhouse gas emission reductions. This report presents the results of these verification tests.

Details on the verification test design, measurement test procedures, and Quality Assurance/Quality Control (QA/QC) procedures can be found in the Test Plan titled *Test and Quality Assurance Plan for Residential Electric Power Generation Using the Plug Power SU1 Fuel Cell System* (7). It can be downloaded from the GHG Center's Web site (www.sri-rtp.com) or the ETV Program web site (www.epa.gov/etv). The Test Plan describes the rationale for the experimental design, the testing and instrument calibration procedures planned for use, and specific QA/QC goals and procedures. The Test Plan was reviewed and revised based on comments received from NYSERDA, Plug Power, and the EPA Quality Assurance Team. The Test Plan meets the requirements of the GHG Center's Quality Management Plan (QMP) and satisfies the ETV QMP requirements. Deviations from the Test Plan were required. These deviations, and the alternative procedures selected for use, are discussed in Section 3.2.3 of this report.

The remainder of Section 1.0 describes the SU1 system technology and test facility and outlines the performance verification procedures that were followed. Section 2 presents test results, and Section 3 assesses the quality of the data obtained.

1.2. SU1 SYSTEM TECHNOLOGY DESCRIPTION

The Plug Power SU1 fuel cell generates electricity through a reaction between H₂, O₂, and a solid electrolyte (the proton exchange membrane). This type of fuel cell operates at relatively low temperatures (about 175 °F) and can vary output fairly quickly to meet changes in demand. The basic principle of operation is to convert H₂ into electrical energy with an electrochemical reaction with O₂, generally supplied from ambient air. Since H₂ fuel is not readily available, fuel cells often employ reformer technologies that convert standard hydrocarbon-based fuels, such as natural gas, into a H₂-rich fuel stream that can be used in the fuel cell stack. PEM fuel cell capacities generally range from 5 to 250 kW with electrical efficiencies ranging from about 25 to 40 percent, depending on manufacturer and installation specifics.

Figure 1-1 is a simplified process flow diagram of the SU1 system. It shows the three main components of the system including: (1) the fuel processor, (2) the fuel cell stack, and (3) the power conditioner, each of which is described below.

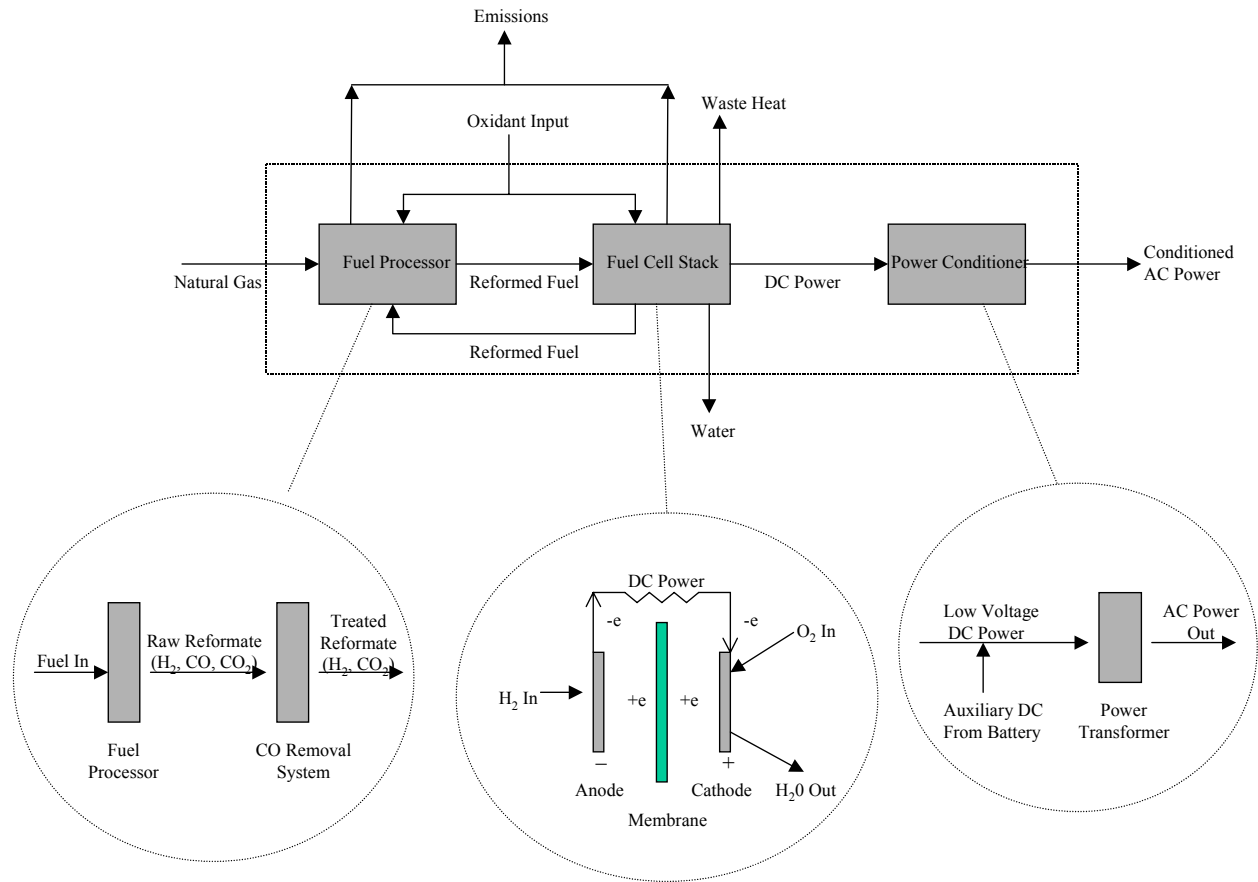

Figure 1-1. SU1 System Process Diagram

A reformed fuel (reformate) rich in H₂ is derived from fuels such as natural gas, propane, methanol, or other petroleum products using a fuel processor because pure H₂ is usually not readily available. Typical fuel-processing methods include catalytic steam reforming (CSR), partial oxidation (POX), and auto-thermal reforming (ATR). Each type of reformer requires a heat source and an O₂ source to oxidize the fuel. The CSR reforming process yields the highest H₂ per unit of fuel, boosting fuel quality and fuel cell efficiency. This occurs because all of the O₂ needed to oxidize the carbon compounds is provided by steam, which also contributes to the H₂ content of the reformate. The POX reforming process uses air to oxidize the fuel and, therefore, no H₂ is contributed by the oxidant. The ATR process uses both air and steam, with the steam providing the O₂ needed to complete the reaction. The SU1 system uses ATR.

The reformate created by fuel processing consists primarily of H₂, CO₂, and CO. The fuel processor also contains a CO cleanup component to remove or transform all or most of the CO to CO₂ and minimize CO damage to the system. Most fuel cells incorporate shift reactors and/or selective oxidation reactors to oxidize the CO to CO₂.

Direct current (DC) electricity is generated in the SU1 fuel cell stack. The stack consists of a series of electrodes (an anode and cathode) separated by an ion-exchange membrane. The reformate is directed into the anode and air enters the system through the cathode stack during operation. The H₂ molecules in the

reformate split into two protons and two electrons in the presence of a catalyst. The electrons flow through an external circuit creating a low-voltage direct DC electrical current. The H⁺ protons pass through the membrane and combine at the cathode with the electrons and O₂ from the air to form water with waste heat as a by-product.

The SU1 also includes a power conditioner. This component uses an inverter to convert the low-voltage DC produced by the stack to alternating current (AC) power. A transformer produces the desired AC voltage output. Power-conditioning transformers are unit-specific and will vary depending on the size and generating capacity of the fuel cell. The SU1 System is equipped with 4 lead-acid batteries to provide auxiliary power during extended periods of peak demand that are higher than fuel cell output capacity, and to aid in starting the SU1 system. The following table summarizes the SU1 system specifications.

Table 1-1. Plug Power SU1 System Specifications (Source: Plug Power, Latham, New York)		
Dimensions	Width Depth Height	32.00 in. 84.50 in. 68.25 in.
Equipment	Fuel cell stack Fuel Processor Peaking batteries Power conditioner components Overall efficiency	Proton exchange membrane (PEM) Auto-thermal reformer (steam) Lead-acid (4 in series, 12v, 105amp) Inverter/EMI filter/grid-connect switch 26%
Electrical	Maximum power output Voltage output Power settings Power quality Electromagnetic compliance Connection type	5 kW 240 VAC at 60 Hz 2.5kW, 4kW, 5kW Confirms to IEEE 519 Standards FCC Class B Grid parallel
Noise Level	Sound pressure level	70 dBA at 3.05 ft
Exhaust Characteristics	Exhaust duct size and configuration Exhaust gas flow at full load Nitrogen oxides (NO _x) Carbon monoxide (CO) Carbon dioxide (CO ₂) Total hydrocarbons (THCs) Sulfur oxides (SO _x) Moisture Oxygen (O ₂) Nitrogen (N ₂)	4-inch round 35 scfm <0.3 ppmv at 15% O ₂ <5.0 ppmv at 15% O ₂ 13 % at 15% O ₂ <0.2 % <0.3 ppmv at 15% O ₂ 35% 4.5 to 6.5% Balance

1.3. TEST FACILITY DESCRIPTION

The Lewiston residence is a typical two-story single family home with a partial basement. The home is located in Niagara County, New York, and includes 2,060 ft² of conventional living space and 700 ft² of basement space. The home was constructed in the early 1970s and contains walls that are insulated at a typical R-11 level and ceilings that are R-19 rated. Space heating at the home is provided by a natural

gas-fired boiler which heats water that is circulated through baseboard heat exchangers using two electric circulating pumps. In addition to standard electrical outlets and lighting fixtures throughout the home, it contains a hot tub, electrical washer, and gas dryer (dryer motor is electric), several ceiling fan/light units, a refrigerator, dishwasher, microwave, several television sets, computer, sump pump, freezer, and other miscellaneous electrical devices. All of the major electric circuits and loads are being continuously monitored as part of the long-term system demonstration being conducted at this home by the DOE and NYSERDA partners (6).

The SU1 fuel cell is not a load-following system, but can be set to operate at nominal power outputs of 2.5, 4.0, or 5.0 kW. The fuel cell interconnect contract with the local utility (Niagara Mohawk) requires that all power generated by the fuel cell and not used by the residence must be directed to the grid with no financial credits. Therefore, if the fuel cell were set to operate at 4.0 or 5.0 kW, the homeowner would be purchasing natural gas for power generation and giving the excess power to the utility for no compensation. This is why the system is normally set to operate at 2.5 kW. Figure 1-2 is a photograph of the Plug Power SU1 system which was installed at the residence in April of 2002.



Figure 1-2. The SU1 System at the Lewiston Residence

1.4. PERFORMANCE VERIFICATION OVERVIEW

The specific verification factors associated with the test are listed below. Brief discussions of each verification factor and its method of determination are presented in Sections 1.4.1 through 1.4.3. Detailed descriptions of testing and analysis methods are not provided here but can be found in the Test Plan.

Power Production Performance

- Electrical power output at selected loads, kW
- Electrical efficiency at selected loads, percent

Power Quality Performance

- Electrical frequency, Hz
- Voltage output, VAC
- Power factor, percent
- Voltage and current total harmonic distortion, percent

Emissions Performance

- CO, NO_x, THC_s, and CH₄ concentrations, ppmv at 15 percent O₂
- CO₂ concentrations, percent
- CO, NO_x, THC_s, CH₄, and CO₂ emission rates, lb/hr and lb/kWh
- Estimated greenhouse gas emission reductions, lb/yr and percent

Each of the verification parameters listed was evaluated during the controlled or extended monitoring periods as summarized in Table 1-2. This table also specifies the dates and time periods during which the testing was conducted.

Table 1-2. Controlled and Extended Test Periods			
Controlled Test Periods			
Date	Time	Test Condition	Verification Parameters Evaluated
04/10/03	11:50 - 17:00	Power output command of 4.0 kW	NO _x , CO, THC, CH ₄ , CO ₂ emissions, electrical power output, and electrical efficiency
04/11/03	08:30 - 12:00	Power output command of 2.5 kW	
04/11/03	15:00 - 18:30	Power output command of 5.0 kW	
Extended Test Period			
Start Date, Time	End Date, Time	Verification Parameters Evaluated	
04/11/03, 18:30	04/21/03, 12:00	Total electricity generated; power quality; and emission offsets	

SU1 system performance had been affected by accelerated stack degradation in the days leading to the scheduled start of verification testing. Electrical efficiency was impacted and the unit was unable to maintain power output levels higher than 2.5 kW. Data indicated that the problem was related to poor quality reformat (reformed fuel gas). Therefore on April 9, Plug Power replaced the main gas reactor can in the reformer and installed a new stack. At that point the SU1 was determined to be operating properly by a Plug Power technician and testing was commenced. Three test runs were executed at each of the three SU1 power command set points to constitute the official controlled tests. Simultaneous monitoring for power output, heat input, ambient meteorological conditions, and exhaust emissions were performed during each of the controlled test periods. Manual samples of natural gas were collected to

determine fuel lower heating value (LHV). Replicate and average electrical power output, energy conversion efficiency (electrical), and exhaust stack emission rates are reported for each test period.

Daily performance of the SU1 system was characterized over a ten-day extended monitoring period following the controlled test periods. The SU1 system was configured to operate 24 hours per day at the power output set by the operator (the homeowner). Primarily, the unit was set for full power output (5 kW), but there were times when the homeowner intentionally changed the output command to 4 or 2.5 kW. Fuel cell downtimes did occur at various times throughout the monitoring period. Fuel cell outages and generating rates are discussed in the test results Section 2.1.2.

The Test Plan specified an extended monitoring period of sufficient duration to capture at least three battery charging cycles. These cycles were expected after reviewing data collected at the site by other parties prior to this verification. The cycles appeared as power output depressions in preliminary SU1 monitoring data provided by the site (see Section 2.2.1 of the Test Plan). Depressions in power output were not evident in the data collected by the GHG Center during the verification period. SU1 power output was very stable during the controlled test periods and the extended monitoring. The source of the depressions in power output evident in the preliminary data remains unknown, but may be associated with the older (and possibly damaged) fuel cell stack or problems with the measurement system used. The GHG Center could not specify a test duration based on the preliminary data and, therefore, used good engineering judgment to decide when sufficient data had been collected. Ten full days of monitoring power output and quality provided the GHG Center with sufficient data to meet the verification's objectives, and the monitoring was concluded.

Results from the extended test are used to report total electrical energy generated and used on site, pollutant emission reductions, and electrical power quality. Emission reductions are estimated using measured fuel cell emission rates, average fuel cell power production rates, and emission estimates for electricity produced at central station power plants.

1.4.1. Power Production Performance

Electrical efficiency determination was based on guidelines listed in ASME Performance Test Code (PTC)-50 (3) and was calculated using the average measured power output, fuel flow rate, and fuel LHV during each 60-minute test period. The electrical power output in kW was measured with a 7600 ION Power Meter (Power Measurements Ltd.). Fuel input was measured with a Rockwell-Invensys Model R-200 diaphragm test meter. Fuel gas sampling and energy content analysis (via gas chromatograph) was conducted according to ASTM procedures to determine the lower heating value of natural gas. Ambient temperature, relative humidity, and barometric pressure were measured near the fuel cell air inlet to support the determination of electrical conversion efficiency as required in PTC-50. Electricity conversion efficiency was computed by dividing the average electrical energy output by the average energy input using Equation 1.

$$\eta = \frac{3412.14 \text{ kW}}{HI} \quad (\text{Eqn. 1})$$

where:

η = efficiency (percent)
kW = average electrical power output measured over the 30-minute interval (kW)

HI = average heat input using LHV over the test interval (Btu/hr); determined by multiplying the average mass flow rate of natural gas to the system converted to standard cubic feet per hour (scfh) times the gas LHV (Btu per standard cubic foot)

3412.14 = converts kw to Btu/hr

1.4.2. Measurement Equipment

Figure 1-3 illustrates the location of measurement instruments that were used in the verification. The 7600 ION electrical power meter continuously monitored the kilowatts of power at a rate of approximately one reading every 8 to 12 milliseconds. These data were averaged every minute using the

GHG Center's data acquisition system (DAS). The 7600 ION was factory-calibrated by Power Measurements, complies with ISO 9002 requirements (ISO 9002: 1999), and is traceable to National Institute of Standards and Technology (NIST) standards. The electric meter was located in the main switchbox connecting the SU1 to the host site and represented power delivered to the residence and power grid. The real-time data collected by the 7600 ION were downloaded and stored on a data acquisition computer using Power Measurements' PEGASYS software. The logged 1-minute average kW readings were averaged over the duration of each controlled test period to compute electrical efficiency.

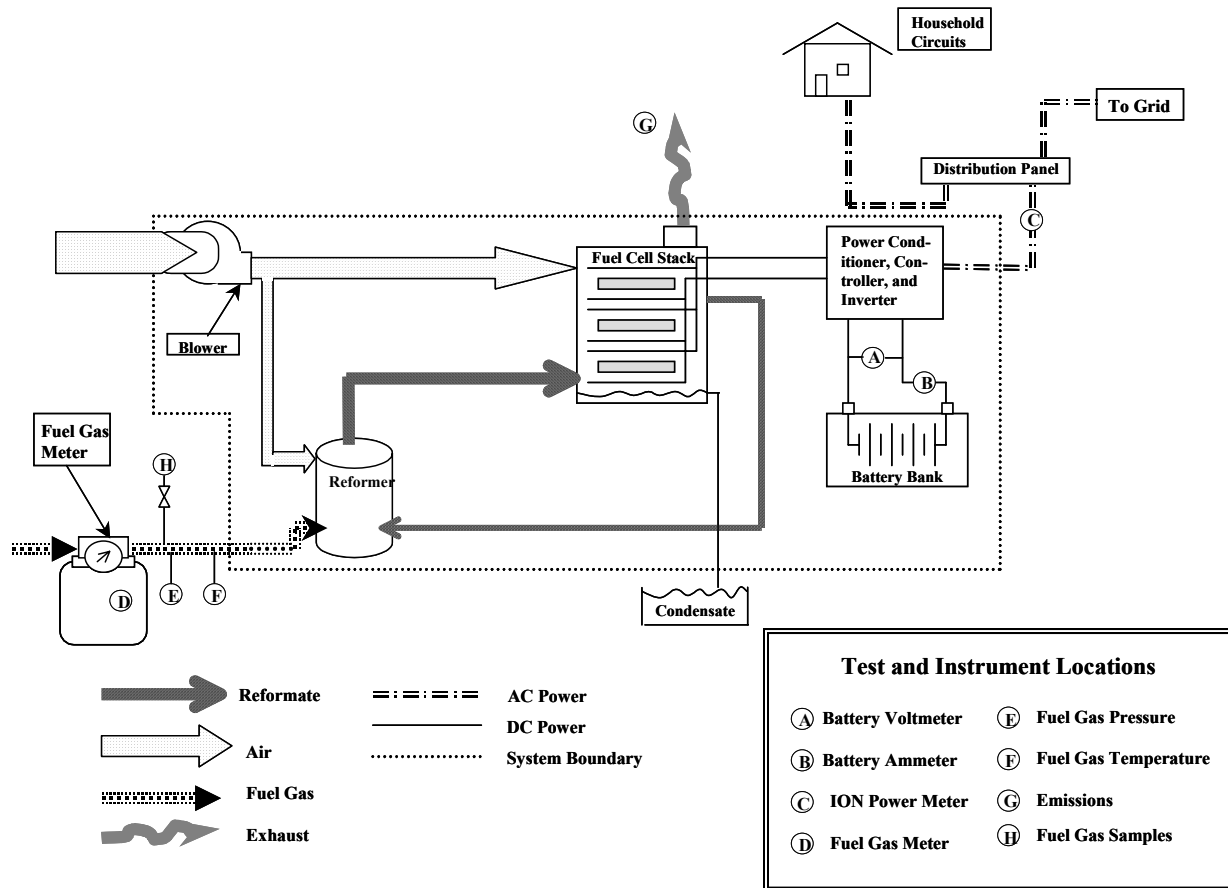

Figure 1-3. Schematic of Measurement System

US EPA ARCHIVE DOCUMENT

For the extended test period, kW readings were integrated over the duration of the verification period to calculate total electrical energy generated in units of kilowatt hours (kWh).

The volumetric flow rate of the fuel was measured using a Rockwell-Invensys Model R-200 diaphragm test meter with a capacity of 0 to 200 acfh, ± 1.0 percent of reading. An Imac Systems Model 400-10P pulse transmitter mounted on the meter's index was combined with an Imac Systems Model R-4 remote totalizer to provide a scaled 4 - 20 mA signal to the DAS. The pulse transmitter system had a resolution of 1 pulse per every 0.01 actual cubic feet. The DAS recorded actual gas flow (acfh) as one-minute averages. Analysts used computer spreadsheets to calculate corrected standard flow (scfh) according to Equation 2.

$$V_g = V_m \left(\frac{P_g}{14.7} \right) \left(\frac{520}{T_g} \right) \left(\frac{Z_{std}}{Z_g} \right) \quad (\text{Eqn. 2})$$

where:

- V_g = Fuel flow rate at standard conditions, scfh
- V_m = Average volumetric flow rate of fuel gas recorded during the test run, acfh
- P_g = Fuel gas pressure, psia
- 14.7 = Gas industry standard pressure, psia
- 520 = Gas industry standard temperature, °R
- T_g = Fuel gas absolute temperature, °R
- Z_{std} = Compressibility factor at standard pressure and temperature, based on gas analysis performed per ASTM D3588 (5)
- Z_g = Compressibility factor at fuel gas pressure and temperature, based on gas analysis performed per ASTM D3588

The GHG Center installed calibrated sensors in the gas pipeline to continuously monitor the fuel gas temperature and pressure during testing. Laboratory analysis of fuel gas samples supplied the required compressibility data.

These data, combined with laboratory analyses of the fuel lower heating value (LHV), allow determination of the SU1 system's heat input according to Equation 3.

$$HI = 60(V_g)LHV \quad (\text{Eqn. 3})$$

where:

- HI = Average heat input using LHV, Btu/hr
- 60 = Minutes per hour
- V_g = Fuel flow rate, scfm, (Eqn. 2)
- LHV = Average fuel gas LHV, Btu/scf

Natural gas samples were collected and analyzed to determine gas composition and heating value. A total of six samples were collected — three during the control test periods and another three during the extended monitoring. The collected samples were submitted to a qualified laboratory (Empact Analytical Systems, Inc. of Brighton, CO) for compositional analysis in accordance with ASTM Specification D1945 for quantification of methane (C_1) to hexanes plus (C_{6+}), nitrogen, oxygen, and carbon dioxide (4). The compositional data were then used in conjunction with ASTM Specification D3588 to calculate LHV and

the relative density of the gas (5). Duplicate analyses were performed by the laboratory on two of the samples to determine the repeatability of the LHV results.

1.4.3. Power Quality Performance

An electrical generator connected in parallel and operated simultaneously with the utility grid creates a number of concerns. The voltage and frequency generated by the power system must be aligned with the power grid. The units must detect grid voltage and frequency while in grid parallel mode to ensure proper synchronization before actual grid connection occurs. The SU1 system electronics contain circuitry to detect and react to abnormal conditions that, if exceeded, cause the unit to automatically disconnect from the grid. These out-of-tolerance operating conditions include overvoltages, undervoltages, and over and under frequencies. The GHG Center has defined in previous tests grid voltage tolerance as the nominal voltage ± 10 percent. Frequency tolerance is 60 ± 0.6 Hz (1.0 percent).

The generator's effects on electrical frequency, power factor, and total harmonic distortion (THD) cannot be completely isolated from the grid. The quality of power delivered actually represents an aggregate of disturbances already present in the utility grid. For example, local SU1 power with low THD will tend to dampen grid power with high THD in the test facility's wiring network. This effect will drop off with increased distance from the generator.

The GHG Center and its stakeholders developed the following power quality evaluation approach to account for these issues. Two documents (1,2) formed the basis for selecting the power quality parameters of interest and the measurement methods used. The GHG Center measured and recorded the following power quality parameters during the 10-day extended period:

- Electrical frequency
- Voltage
- Voltage THD
- Current THD
- Power factor

The ION 7600 power meter used for power output determinations was used to perform these measurements as described below and detailed in the Test Plan. The factory calibrated the ION power meter to ANSI standards (1) prior to field installation. The ION power meter continuously measured electrical frequency at the SU1's distribution panel. The DAS was used to record one-minute averages throughout the extended period. The mean frequency, maximum, minimum, and standard deviation are reported.

The SU1 generates power at 240 VAC. The electric power industry accepts that voltage output can vary within ± 10 percent of the standard voltage without causing significant disturbances to the operation of most end-use equipment. Deviations from this range are often used to quantify voltage sags and surges. The ION power meter continuously measured true root mean square (rms) line-to-line voltage at the generator's distribution panel for each phase pair. True rms voltage readings provide the most accurate representation of AC voltages. The DAS recorded one-minute averages throughout the extended period. The mean voltage, maximum, minimum, and standard deviation are also reported.

THD results from the operation of non-linear loads. Harmonic distortion can damage or disrupt many kinds of industrial and commercial equipment. Voltage harmonic distortion is any deviation from the pure AC voltage sine waveform. The ION power meter applies Fourier analysis algorithms to quantify

THD. Fourier showed that any wave form can be analyzed as one sum of pure sine waves with different frequencies and that each contributing sine wave is an integer multiple (or harmonic) of the lowest (or fundamental) frequency. The fundamental is 60 Hz for electrical power in the U.S. The 2nd harmonic is 120 Hz, the 3rd is 180 Hz, and so on. Certain harmonics, such as the 5th or 12th, can be strongly affected by the types of devices (i.e., capacitors, motor control thyristors, inverters) connected to the distribution network.

The magnitude of the distortion can vary for each harmonic. Each harmonic's magnitude is typically represented as a percentage of the rms voltage of the fundamental. The aggregate effect of all harmonics is called THD. THD amounts to the sum of the rms voltage of all harmonics divided by the rms voltage of the fundamental, converted to a percentage. THD gives a useful summary view of the generator's overall voltage quality. Based on "recommended practices for individual customers" in the IEEE 519 standard (2), the specified value for total voltage harmonic is a maximum THD of 5.0 percent.

The ION meter continuously measured voltage THD up to the 63rd harmonic. The DAS recorded one-minute voltage THD averages throughout the test period and reported the mean, minimum, maximum, and standard deviation for the average THD.

Current THD is any distortion of the pure current AC sine waveform and, similar to voltage THD, can be quantified by Fourier analysis. The current THD limits recommended in the 519 Standard range from 5.0 to 20.0 percent, depending on the size of the generator, the local demand, and its distribution network design as compared to the capacity of the local utility grid. The ION power meter also continuously measured current THD and reported the mean, minimum, maximum, and standard deviation .

Power factor is the phase relationship of current and voltage in AC electrical distribution systems. Ideal conditions result in current and voltage are in phase, which results in a unity (100 percent) power factor. Power factors are less than this optimum value if reactive loads are present. Unity power factor is preferred but the actual power factor of the electricity supplied by the utility may be much lower because of load demands of different end users. Typical values ranging between 60 and 90 percent are common. Low power factor causes heavier current to flow in power distribution lines for a given number of real kilowatts delivered to an electrical load.

The ION power meter continuously measured average power factor for the SU1. The DAS recorded one-minute averages for each phase during all test periods. The GHG Center reported maximum, minimum, mean, and standard deviation averaged over all three phases.

1.4.4. Emissions Performance

Pollutant concentration and emission rate measurements for NO_x, CO, THC_s, CH₄, and CO₂ were conducted on the SU1 exhaust stack during the controlled test periods. Emissions testing coincided with the efficiency determinations described earlier. All of the test procedures used are U.S. EPA Federal Reference Methods, which are well documented in the Code of Federal Regulations. The reference methods include procedures for selecting measurement system performance specifications and test procedures, quality control procedures, and emission calculations — 40CFR60, Appendix A (9). Table 1-3 summarizes the standard test methods that were followed.

Table 1-3. Summary of Emissions Testing Methods

Exhaust Stack				
Pollutant	EPA Reference Method	Analyzer Type	Instrument Range	Instrument Detection Limit
NO _x	20	Horiba Model CLA-510SS (chemiluminescence)	0 - 2 ppm	20 ppb
CO	10	TEI Model 48L (NDIR)	0 - 10 ppm	40 ppb
THC, CH ₄	18	Hewlett - Packard 5890 (GC/FID)	0 - 1,000 ppm	2 ppm
CO ₂	3A	Servomex Model 1440 (NDIR)	0 - 10%	0.02 %
O ₂	3A	Servomex Model 1440 (electrochemical)	0 - 25%	0.02 %

Certain modifications to the standard Reference Methods were implemented to address the unique nature of fuel cell exhaust gas composition. The following modifications were implemented:

1. Ambient level NO_x and CO analyzers were used to detect the low levels of pollutants.
2. A mass flow controller was used to dilute EPA Protocol 1 calibration gases so that the analyzers could be calibrated at these low ranges.
3. All sampling system surfaces contacting the gas stream were either virgin materials or cleaned with Alconox prior to testing.
4. Special precautions were taken to minimize condensation of water in the sampling train.

A complete discussion of these modifications and the data quality requirements is presented in the Test Plan. Sampling was conducted during controlled test periods for no less than 30 minutes at a single point near the center of the 4-inch diameter stack. Results of the instrumental testing are reported in units of parts per million by volume dry (ppmvd) and ppmvd corrected to 15% O₂. The emissions testing was conducted by ENSR International of East Syracuse, New York, under the on-site supervision of the GHG Center field team leader. A detailed description of the sampling system used for criteria pollutants, greenhouse gases, THCs, and O₂ is provided in the Test Plan and is not repeated here. A brief description of key features is provided below.

To ensure that the CO₂, O₂, NO_x, and CO instruments operate properly and reliably, the flue gas is conditioned prior to introduction into the analyzers. The gas conditioning system used for this test was designed to remove water vapor and/or particulate from the sample. The gas was directed to a specialized thermo-electric moisture removal system through a very short, heated Teflon line (approximately two feet) to minimize contact between condensed moisture and the exhaust gases. This condenser removed moisture from the gas stream. The clean, dry sample was then transported to a flow-distribution manifold where sample flow to each analyzer was controlled at three liters per minute (lpm). Calibration gases were routed through this manifold to the sample probe to perform bias and linearity checks.

NO_x concentrations were determined using a Horiba Model CLA-510SS. This analyzer catalytically reduces NO₂ in the sample gas to nitric oxide (NO). The gas is then catalytically converted to excited NO₂ molecules by oxidation with ozone (O₃) (normally generated by ultraviolet light). The resulting NO₂

emits light (luminesces) in the infrared region. The emitted light is measured by an infrared detector and reported as NO_x . The intensity of the emitted energy from the excited NO_2 is proportional to the concentration of NO_2 in the sample. The efficiency of the NO to NO_2 catalytic converter is checked as an element of instrument setup and checkout. The NO_x analyzer was calibrated to a range of 0 to 2 ppmvd.

A TEI Model 48L gas filter correlation analyzer with an optical filter arrangement was used to determine CO concentrations. This method provides high specificity for CO. Gas filter correlation uses a constantly rotating filter with two separate 180-degree sections. One section of the filter contains a known concentration of CO and the other section contains an inert gas without CO. The sample gas is passed through the sample chamber containing a light beam in the spectral region absorbed by CO. The sample is then measured for CO absorption with and without the CO filter in the light path. These two values are correlated, based upon the known concentrations of CO in the filter, to determine the concentration of CO in the sample gas. The CO analyzer was operated on a range of 0 to 10 ppmvd.

THC and CH_4 concentrations in the exhaust gas were measured following EPA Method 18 procedures. Samples were collected in 6-liter Tedlar bags in conjunction with each test run and submitted to Columbia Analytical Services of Simi Valley, California. Analyses were conducted using a Hewlett Packard 5890 GC/FID. Emission rates are reported on an equivalent dry methane basis.

A Servomex Model 1440 analyzer equipped with a non-dispersive infrared (NDIR) detector was used for determination of CO_2 concentrations. NDIR measures the amount of infrared light that passes through the sample gas versus through a reference cell. The degree of light attenuation is proportional to the CO_2 concentration in the sample because CO_2 absorbs light in the infrared region. The CO_2 analyzer range was set at 0 to 10 percent. The same analyzer is equipped with an electrochemical cell used to monitor O_2 concentrations. The O_2 analyzer range was set at 0 to 25 percent.

The instrumental testing for CO_2 , O_2 , NO_x , CO, CH_4 , and THC yielded concentrations in units of ppmvd and ppmvd corrected to 15% O_2 . The Test Plan specified that exhaust gas flow rate determinations via Method 2C would be conducted during each test to convert the measured pollutant concentrations to mass emissions in terms of pounds per hour (lb/hr). Because low gas flow levels were expected, the Test Plan also specified special precautions to Method 2C to improve measurement accuracy. These included use of a high sensitivity digital micromanometer to measure velocity head, and execution of the "standard addition spiking procedure" to evaluate accuracy. During testing however, it was determined by the field team leader that exhaust gas flow measurement accuracy was still questionable even after following these procedures due to the extremely low gas flow rates. Therefore, an alternative procedure was implemented that provided a more accurate exhaust gas flow rate determination. Specifically, Reference Method 19 guidelines for determination of emission rates based on fuel consumption was used.

Method 19 employs fuel factors (i.e., F-factors) and the heat input rate (MMBtu/hr) to convert measured pollutant concentrations to emission rates in pounds per hour (lb/hr). F-factors are the ratio of exhaust gas volume to the heat content of the fuel, and are calculated as a volume/HI value, (e.g., standard cubic feet per million Btu). The F-factor can be calculated from CO_2 or O_2 values, on a wet or dry basis, as dictated by the measurement conditions for the gas concentration determinations. Method 19 includes all calculations required to compute the F-factors and guidelines on their use. The Method 19 published O_2 based F-factor for natural gas [8,710 dry standard cubic feet per million British thermal units (dscf/MMBtu)] was used here, along with measured exhaust gas O_2 levels and gas consumption rates. These measurements, being more accurate than the Method 2C procedures, allowed better accuracy on the emission rate determinations. More detail regarding the overall accuracy of the determinations is provided in Section 3.2.3.

The mass emission rates as lb/hr were then normalized to electrical power output by dividing the mass rate by the average power output measured during each controlled test and are reported as pounds per kilowatt-hour (lb/kWh).

1.4.5. Estimated Annual Emission Reductions for the Lewiston Residence

All of the electrical power demand at the residence is met by the local utility, Niagara Mohawk (NiMo), when the SU1 system is not generating electricity. Electricity generation from central power stations defines the baseline power scenario for the residence and emissions of NO_x and CO₂ generated by these stations represent the baseline emissions in the absence of the SU1 system. Some of the power demand of the residence is met through on-site generation when the SU1 system is operating. Less power is purchased from the utility grid in this scenario. If emissions of CO₂ and NO_x with the SU1 system scenario are lower than the emissions associated with the baseline scenario, then a reduction in emissions would be realized under the SU1 system scenario.

This verification compared emissions from the SU1 system with the baseline scenario to estimate annual NO_x and CO₂ emission levels and reductions (lb/yr). These pollutants were considered because CO₂ is the primary greenhouse gas emitted from combustion processes and NO_x is also a greenhouse gas. Reliable emission factors for electric utility grid are available for both gases. Emission reductions are computed as follows:

$$\text{Annual Emission Reductions (lb/yr)} = [\text{Baseline Scenario Emissions}] - [\text{SU1 system Scenario Emissions}]$$

$$\text{Annual Emission Reductions (percent)} = \frac{\text{Annual Emission Reductions (lb/yr)}}{[\text{Baseline Scenario Emissions}] * 100}$$

The following 3 steps briefly describe the methodology used.

Step 1 - Determination of the Annual Electrical Energy Profile of the Lewiston Residence

The first step in estimating emission reductions is to determine the annual electrical energy demand of the residence on a monthly basis. The NYSERDA partnership closely monitors the home's demand as part of the residence's long-term demonstration. These data were compiled for the calendar year 2002 and are summarized in Table 1-4. The monthly residence demand values represented the baseline scenario where all demand is met using power purchased from the grid. The data show that average baseline demand for the residence range from about 2.4 to 3.9 kW depending on season. The monthly demand data were then used to estimate the distribution of energy demand as supplied by the systems in the baseline and SU1 system scenarios.

The SU1 is not a load-following generator and any power generated that exceeds instantaneous residence demand is exported to the grid. The homeowner is not compensated for exported power and for this reason, the SU1 is normally operated at a power output setting of 2.5 kW. Therefore, the average power output measured during the 2.5 kW power output tests (2.57 kW), along with the number of operating days in each month and the SU1 availability rate measured during the extended monitoring period (74 percent availability), were used to calculate the monthly power generated on-site. Using this approach, the SU1 generation rate was lower than the residence demand for each month.

Table 1-4. Electrical Demand for the Lewiston Residence During 2002

	Monthly Residence Electrical Demand kWh	Baseline Scenario	SU1 System Scenario	
		Power Supplied by Utility Grid kWh _{Grid}	Power Supplied by SU1 System ^a kWh _{SU1}	Power Supplied by Grid kWh _{Grid}
Jan	2,899	2,899	1,415	1,484
Feb	2,376	2,376	1,278	1,098
Mar	2,106	2,106	1,415	691
Apr	1,955	1,955	1,369	586
May	1,934	1,934	1,415	519
June	1,805	1,805	1,369	436
July	1,923	1,923	1,415	508
Aug	1,829	1,829	1,415	414
Sept	1,803	1,803	1,369	434
Oct	2,767	2,767	1,415	1,352
Nov	2,295	2,295	1,369	926
Dec	2,347	2,347	1,415	932
Annual Total	26,039	26,039	16,660	9,379

^a Based on a measured availability of 74 percent, and an average power output of 2.57 kW.

Step 2 – Emissions Estimate For the SU1 System

Using the energy production data for the SU1 system, emissions associated with this system were estimated as follows:

$$E_{SU1} = kWh_{SU1} * ER_{SU1} \tag{Eqn. 4}$$

where:

- E_{SU1} = SU1 system emissions, lb/yr
- kWh_{SU1} = Electrical energy generated by SU1 system, Table 1-4, kWh_{SU1}
- ER_{SU1} = SU1 system emission rate, lb/kWh

The CO₂ and NO_x emission rates defined above are equivalent to the average emission rate determined during the verification test at the 2.5 kW power output setting.

Step 3 - Emissions Estimate for the Utility Grid

Emissions associated with electricity generation at central power stations is defined by the following equation:

$$E_{Grid} = kWh_{Grid} * 1.078 * ER_{Grid} \quad (\text{Eqn. 5})$$

where:

E_{Grid}	=	grid emissions (lb/yr)
kWh_{Grid}	=	electricity supplied by the grid, Table 1-4 (kWh)
1.078	=	transmission and distribution system line losses
ER_{Grid}	=	NY ISO-displaced emission rate (lb/kWh)

The kWh_{Grid} variable shown above represents the estimated electricity supplied by the utility grid under the baseline scenario and the SU1 system scenario (Table 1-4). These values are increased by a factor of 1.078 to account for line losses between central power stations and the end user.

Defining the grid emission rate (ER_{Grid}) is complex and the methodology for estimating this parameter is continuously evolving. The discussion presented in Appendix B-1 provides a brief background on the concept of displaced emissions and presents the strategy employed by the GHG Center to assign ER_{Grid} for this verification.

2.0 VERIFICATION RESULTS

The verification period started on April 10, 2003, and continued through April 21, 2003. The controlled tests were conducted on April 10 and 11, and were followed by an extended ten-day period of continuous monitoring to examine power output, power quality, and emission reductions. During the controlled and extended monitoring test periods, the GHG Center acquired several types of data that are the basis of verification results presented here. The following types of data were collected and analyzed during the verification:

- Continuous measurements (i.e., gas flow, gas pressure, gas temperature, power output and quality, and ambient conditions)
- Fuel gas compositional data
- Emissions testing data

The field team leader reviewed, verified, and validated some data (e.g., DAS file data, reasonableness checks) while on site. The team leader reviewed collected data in the field for reasonableness and completeness. The data from each of the controlled test periods were reviewed on-site to verify that PTC 50 variability criteria were met. The emissions testing data was validated by reviewing instrument and system calibration data and ensuring that those and other reference method criteria were met. Factory calibrations for fuel flow, pressure, temperature, power output, and ambient monitoring instrumentation were reviewed on-site to validate instrument functionality. Other data such as fuel LHV analysis results, were reviewed, verified, and validated after testing had ended. All collected data were reviewed and classed as valid, suspect, or invalid using the QA/QC criteria specified in the Test Plan. Review criteria are in the form of factory and on-site calibrations, maximum calibration and other errors, audit gas analyses results, and lab repeatability results. All results presented here are generally based on measurements which met the specified Data Quality Indicators (DQIs) and QC checks and were validated by the GHG Center.

The days listed above include periods when the unit was operating normally. Although the GHG Center has made every attempt to obtain a reasonable set of data to examine daily trends in atmospheric conditions, electricity production, and power quality, these results may not represent performance over longer operating periods or at significantly different operating conditions (especially the severe winter weather conditions that can be experienced at this site). Since the verification testing occurred in April and the SU1 system and its intake air was located outdoors, the GHG Center was able to capture a relatively wide temperature range during the period. Temperatures ranged from a low of 27 °F to a high approaching 81 °F during the extended test period. This is a fairly representative range for this region, but clearly excludes information related to the system's response to extremely low ambient temperatures that are encountered in this and other regions.

Test results are presented in the following subsections:

- Section 2.1 – Power Production Performance
(short-term controlled testing and ten days of extended testing)
- Section 2.2 - Power Quality Performance
(ten days of extended testing)
- Section 2.3 - Emissions Performance and Reductions
(controlled test periods)

The results show that the quality of power generated by the SU1 system is generally high and that the unit is capable of operating in parallel with the utility grid. The unit produced between 2.2 and 4.9 kW of electrical power depending on command. Power output was not impacted by the range of ambient temperatures observed. Electrical efficiency averaged 24.3 percent. NO_x and CO concentrations at full load were 0.04 and 0.2 ppmvd or less, respectively (corrected to 15-percent O₂) during the controlled test periods. NO_x emission reductions are estimated to be at least 64 percent and annual CO₂ emissions reductions are estimated to be 1.7 percent.

An assessment of the quality of data collected throughout the verification period is provided in Section 3.0. The data quality assessment is then used to demonstrate whether the data quality objectives (DQOs) introduced in the Test Plan were met for this verification.

2.1 POWER PRODUCTION PERFORMANCE

The power production performance evaluation included electrical power output and efficiency determination during controlled test periods. The performance evaluation also included determination of total electrical energy generated over the extended test period.

2.1.1 Electrical Power Output and Efficiency During Controlled Tests

Table 2-1 summarizes the power output and efficiency performance of the SU1 system. All controlled testing occurred during relatively consistent atmospheric conditions: 44 °F average ambient temperature, 60 percent average RH, and 14.5 psia average barometric pressure. Actual conditions encountered during testing were relatively consistent with standard conditions defined by the ISO (59 °F, 62 percent RH, and 14.696 psia). The results shown in Table 2-1 and the discussion that follows, are representative of conditions encountered during testing and are not intended to indicate performance at other operating conditions (e.g., cooler temperatures, different elevations). Natural gas fuel input characteristics corresponding to these efficiency results are summarized in Table 2-2.

Table 2-1. Power Production Performance During Controlled Test Periods							
Test ID	Power Command (kW)	Heat Input (MBtu/hr)	Electrical Power Generation Performance		Ambient Conditions		
			Power Delivered (kW)	Electrical Efficiency (%)	Temp. (°F)	RH (%)	Pressure (psia)
Run 1	4.0	53.51	3.91	24.9	40.0	68	14.58
Run 2		54.18	3.92	24.7	40.4	69	14.56
Run 3		54.00	3.90	24.6	41.3	67	14.55
Avg.		53.90	3.91	24.7	40.6	68	14.56
Std. Dev.		0.35	0.01	0.15	0.67	1.0	0.02
Run 4	2.5	35.73	2.58	24.7	40.9	66	14.45
Run 5		36.17	2.59	24.4	43.9	59	14.45
Run 6		35.61	2.54	24.3	44.4	58	14.44
Avg.		35.84	2.57	24.5	43.1	61	14.45
Std. Dev.		0.29	0.03	0.21	1.89	4.4	0.01
Run 7	5.0	68.93	4.77	23.6	47.2	61	14.40
Run 8		67.54	4.74	23.9	48.5	58	14.40
Run 9		67.69	4.75	23.9	49.7	54	14.39
Avg.		68.05	4.75	23.8	48.5	57	14.40
Std. Dev.		0.76	0.02	0.17	1.25	3.5	0.01

Table 2-2. SU1 Fuel Input During Controlled Test Periods					
Test ID	Power Command (kW)	Natural Gas Fuel Input			
		Gas Flow Rate (scfh)	Gas LHV (Btu/scf)	Gas Pressure (psig)	Gas Temp. (°F)
Run 1	4.0	58.07	921.7	0.24	42
Run 2		58.80	--	0.24	42
Run 3		58.61	921.1	0.24	43
Avg.		58.49	921.4	0.24	42
Std. Dev.		0.38	0.42	0.00	0.6
Run 4	2.5	38.64	924.2	0.24	40
Run 5		39.12	--	0.25	44
Run 6		38.51	--	0.25	45
Avg.		38.76		0.25	43
Std. Dev.		0.32	0.01	2.7	
Run 7	5.0	74.55	--	0.25	49
Run 8		73.04	--	0.25	48
Run 9		73.21	925.0	0.26	50
Avg.		73.60	924.6	0.25	49
Std. Dev.		0.83	0.57	1.0	

The average electrical power delivered was 4.75 kW_e at full load, and the average electrical efficiency corresponding to these measurements was 23.8 percent. The average electrical efficiency at all three power commands was 24.3 percent. Electric power generation heat rate, which is an industry-accepted term to characterize the ratio of heat input to electrical power output, was measured to be 14,327 Btu/kWh_e at full power. Figure 2-1 plots SU1 power output and electrical efficiency during the controlled test periods.

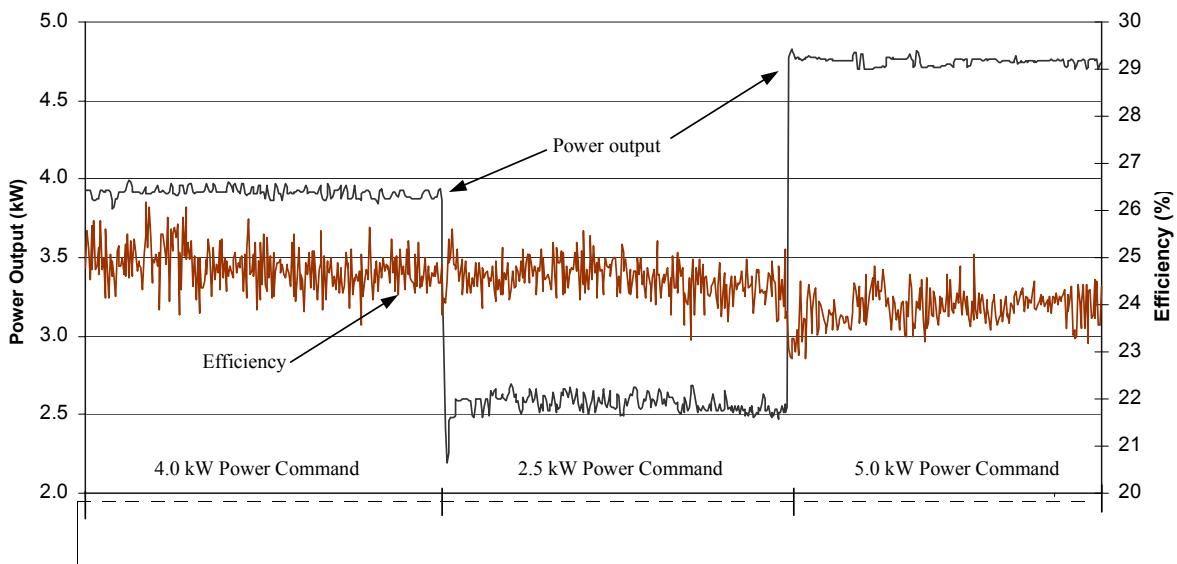

Figure 2-1. Power Output and Efficiency During Controlled Test Periods

2.1.2 Electrical Energy Production Over the Extended Test

Figure 2-2 presents a time series plot of power production during the ten-day extended verification period. Data was continuously collected for a total time period of 233.5 hours. Although the SU1 at this site is normally set to generate 2.5 kW, the homeowner intentionally changed the power setting several times during this verification period to expand the power quality evaluation (the system can be set to produce 2.5, 4, or 5 kW). In addition, there were six occasions when the unit shut down for a variety of reasons including insufficient water supply (the system requires a source of deionized water) and internal temperature warnings. The unit was successfully restarted in each case by the homeowner, but sometimes the shutdown was not detected until after long outage periods. SU1 operations during the extended monitoring period are summarized as follows:

<u>Power Setting</u>	<u>Approximate hours</u>
Shut down	61
2.5 kW	11
4 kW	69
5 kW	93

The unit was down for a total of approximately 61 hours during the 10-day period. This equates to a system availability of approximately 74 percent during the verification period. It should be noted that the total downtime might have been much lower if the system were continuously monitored by an operator. Figure 2-2 excludes periods of time when the unit was not operating.

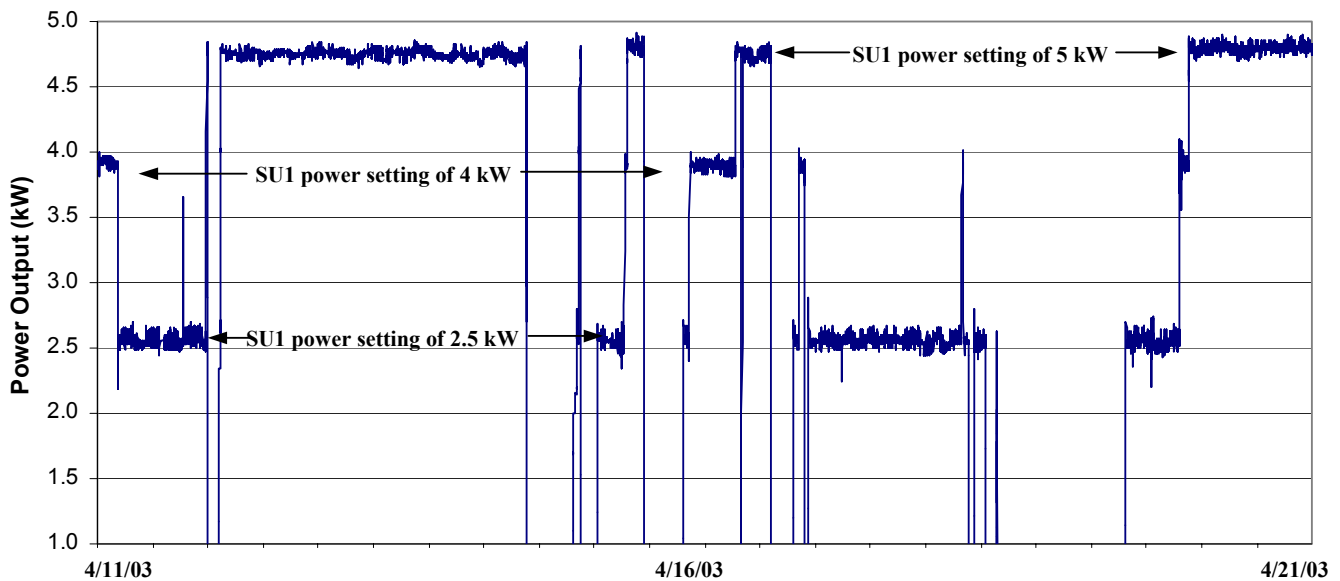

Figure 2-2. Power Production During the Extended Test Period

A total of 689 kWh electricity were generated over an operating period of 233.5 hours during the extended monitoring period. Any electricity generated by the SU1 and not consumed at the residence was exported to the grid. The average power generated over the extended period was 2.95 kW, including periods when the SU1 was not operating. Power production showed very little variation at each of the power commands. The effect of ambient temperature on power output (and fuel consumption) inherent to other DG technologies was not observed, as illustrated in Figure 2-3. The figure clearly shows that power output is not significantly affected by the ambient temperature (intake air). There is a slight trend for higher power output at the 5 kW power command as ambient temperature increases.

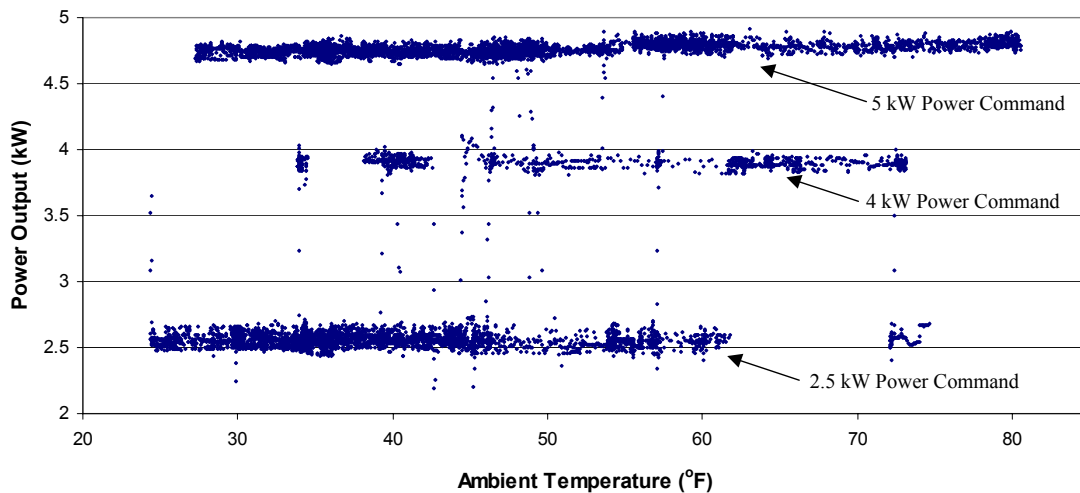

Figure 2-3. Effects of Ambient Temperature on SU1 Power Production

The GHG Center monitored SU1 electrical efficiency for three consecutive days during the extended monitoring period. These data do not include the full range of ambient temperatures shown in Figure 2-3, but demonstrate stability in efficiency in the temperature range of approximately 25 to 55 °F. As shown in Figure 2-4, there is a very small decrease in efficiency at the higher ambient temperatures (from around 24.0 to 23.5 percent).

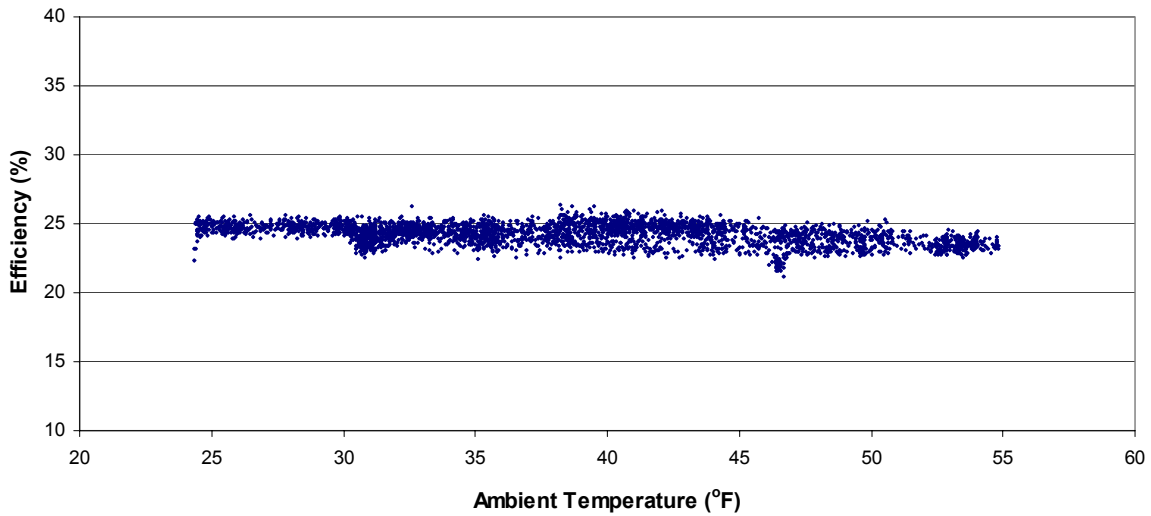

Figure 2-4. Effects of Ambient Temperature on SU1 Efficiency

2.2 POWER QUALITY PERFORMANCE

Power quality for the SU1 was recorded continuously during the 10-day extended monitoring period. The power quality data summarized in the following sections excludes all of the data collected during this period while the unit was shut down, and includes all of the data collected while the unit running at generating set-points of 2.5, 4, or 5 kW.

2.2.1 Electrical Frequency

Electrical frequency measurements (voltage and current) were monitored simultaneously for the SU1 system. The one-minute average data collected by the electrical meter were analyzed to determine maximum frequency, minimum frequency, average frequency, and standard deviation for the verification period. These results are illustrated in Figure 2-5 and summarized in Table 2-3. The average electrical frequency measured was 60.001 Hz, and the standard deviation was 0.015 Hz.

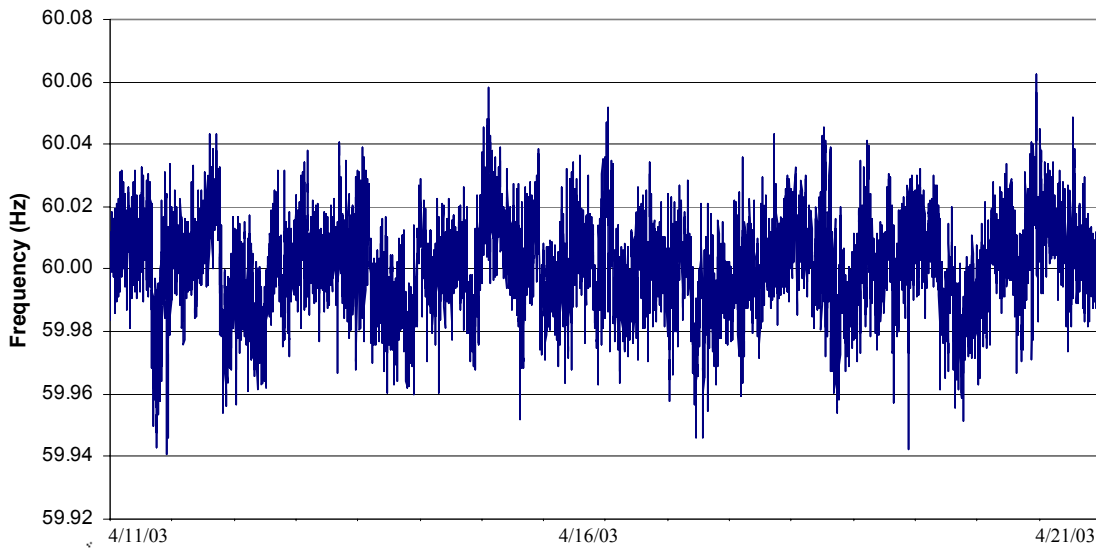

Figure 2-5. SU1 System Electrical Frequency During Extended Test Period

Table 2-3. SU1 Electrical Frequency During Extended Period	
Parameter	Frequency (Hz)
Average Frequency	60.001
Minimum Frequency	59.941
Maximum Frequency	60.062
Standard Deviation	0.015

2.2.2 Voltage Output

It is generally accepted that voltage output can vary within ± 10 percent of the standard voltage (120 volts) without causing significant disturbances to the operation of most end-use equipment. SU1 voltage was monitored using the 7600 ION electric meter. The meter was configured to measure 0 to 300 VAC. The fuel cell was grid-connected and operated as a voltage-following current source. As a result, the voltage levels measured are more indicative of the grid voltage levels that the SU1 tried to mimic (typically around 120 volts at the specific location).

Figure 2-6 plots 1-minute average voltage readings, and Table 2-4 summarizes the statistical data for the voltages measured on the SU1 throughout the verification period. The voltage levels were well within the normal accepted range of ± 10 percent.

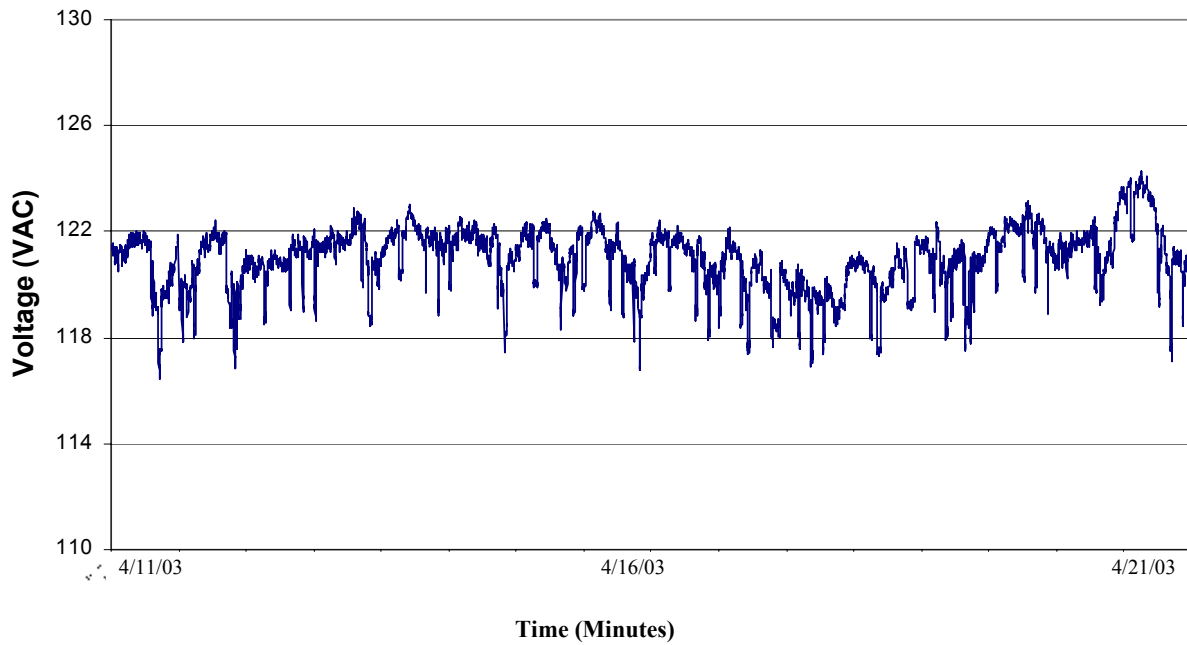

Figure 2-6. SU1 System Voltage During Extended Test Period

Table 2-4. SU1 Voltage During Extended Period	
Parameter	Volts
Average Voltage	120.98
Minimum Voltage	116.43
Maximum Voltage	124.26
Standard Deviation	1.17

2.2.3 Power Factor

Figure 2-7 plots one-minute average power factor readings and Table 2-5 summarizes the statistical data for power factors measured on the SU1 system throughout the extended monitoring period. SU1 power output levels are included in Figure 2-7 to illustrate that power factor changes as power output changes. The highest power factors were observed while the unit was operated at a power command of 5 kW. The figure shows that even at 2.5 kW operation, the SU1 power factor was 99.6 percent or higher.

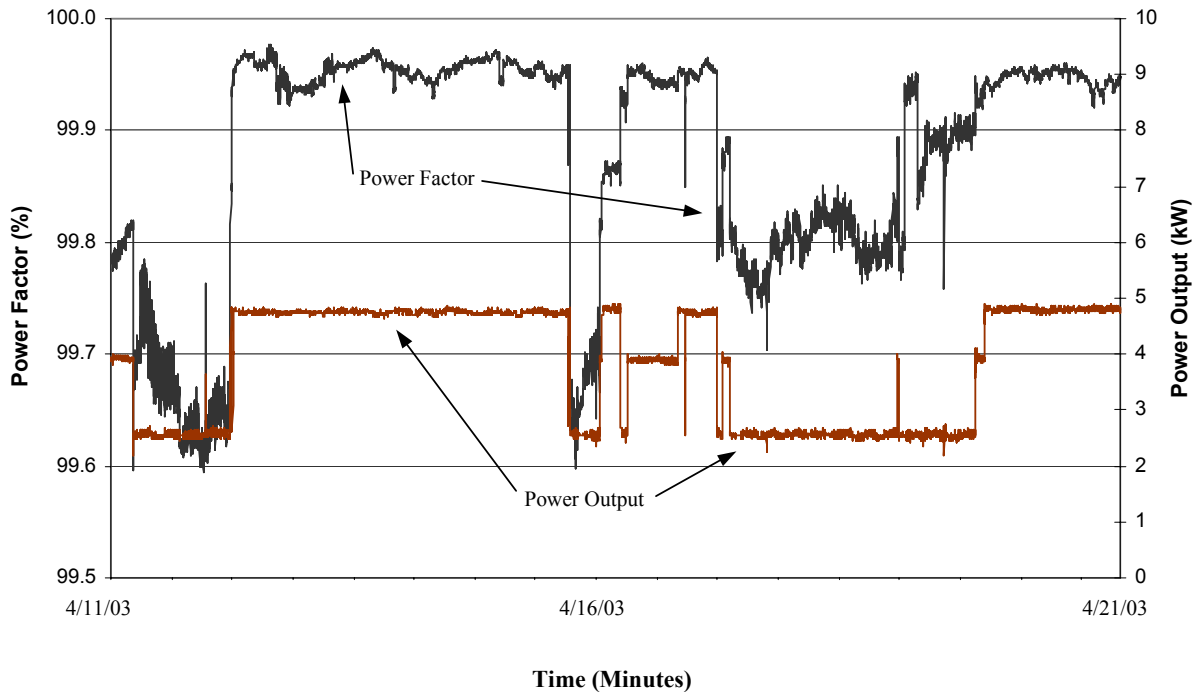

Figure 2-7. SU1 System Power Factors During Extended Test Period

Table 2-5. SU1 Power Factors During Extended Period	
Parameter	%
Average Power Factor	99.88
Minimum Power Factor	99.59
Maximum Power Factor	99.98
Standard Deviation	0.10

2.2.4 Current and Voltage Total Harmonic Distortion

The SU1's total harmonic distortion, up to the 63rd harmonic, was recorded for current and voltage output using the 7600 ION. The average current and voltage THDs were measured to be 2.85 percent and 2.69 percent, respectively (Table 2-6). Figure 2-8 plots the current and voltage THDs throughout the ten day extended verification period.

Table 2-6. SU1 THDs During Extended Period		
Parameter	Current THD (%)	Voltage THD (%)
Average	2.85	2.69
Minimum	1.45	2.12
Maximum	9.57	3.46
Standard Deviation	0.84	0.30

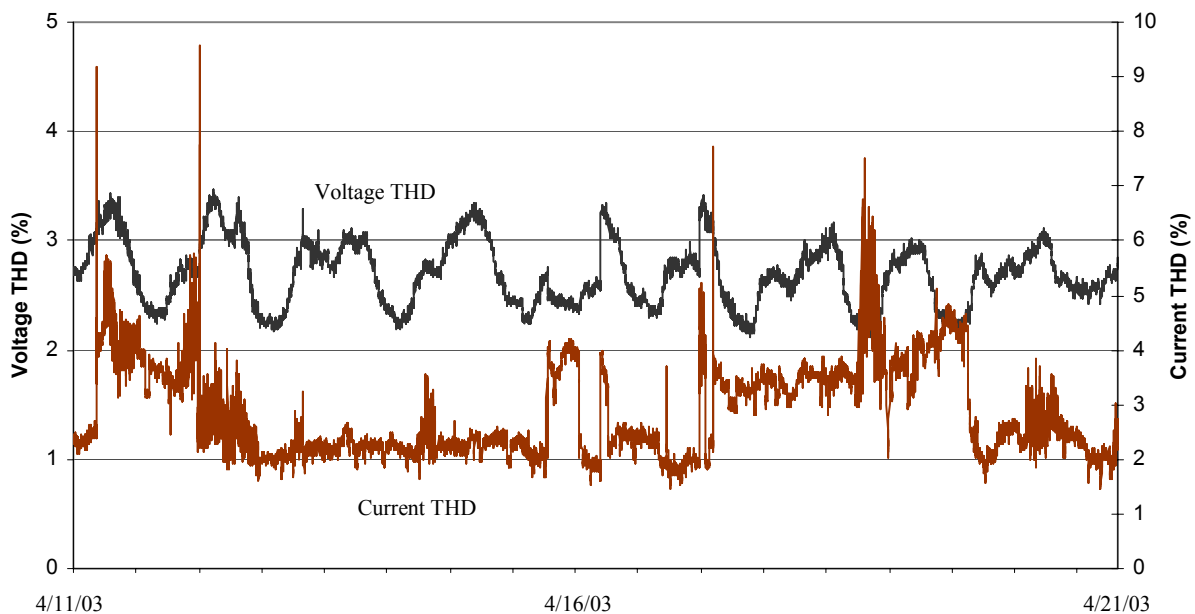

Figure 2-8. SU1 System Current and Voltage THD During Extended Test Period

As shown in Figure 2-8, voltage THD shows a diurnal trend in variation, with the higher values occurring during the late afternoon and evening hours. All voltage THD readings were below the IEEE 519 threshold of $\pm 5\%$. There were four occasions where current THD exceeded the $\pm 5\%$ specification. Three of these events were spikes of one minute or less in duration and the fourth lasted approximately two hours on April 18 (between 0300 and 0500). These spikes are included in the data presented in Table 2-6 and Figure 2-8. The cause of the excessive current THD was not determined.

2.3 EMISSIONS PERFORMANCE

2.3.1 SU1 System Stack Exhaust Emissions

Testing was conducted to determine SU1 emission rates for criteria pollutants (NO_x, and CO) THC and greenhouse gases (CO₂ and CH₄). Stack emission measurements were conducted concurrently with electrical power output and efficiency measurements. Three replicate test runs were conducted at each operating condition. All testing was conducted in accordance with the EPA Reference Methods listed in Table 1-3. The SU1 system was maintained in a stable mode of operation during each test run using PTC-50 variability criteria (Sections 2.1 and 3.2.2.1).

Emissions results are reported in units of parts per million corrected to 15-percent O₂ (ppmvd at 15-percent O₂) for NO_x, CO, and THC. Emissions of CO₂ are reported in units of volume percent. These concentration and volume percent data were converted to mass emission rates using exhaust stack flow rates measured using EPA Method 2C procedures and are reported in units of pounds per hour (lb/hr). The emission rates are also reported in units of pounds per kilowatt hour electrical output (lb/kWh_e). They were computed by dividing the mass emission rate by the electrical power generated.

Sampling system QA/QC checks were conducted in accordance with Test Plan specifications to ensure the collection of adequate and accurate emissions data. These included analyzer linearity tests, sampling system bias and drift checks, interference tests, and use of audit gases. Results of the QA/QC checks are discussed in Section 3. The results show that DQOs for all gas species met the reference method requirements. A complete summary of emissions testing equipment calibration data is presented in Appendix A.

Table 2-7 summarizes the emission rates measured during each run and the overall average emissions for each set of tests. Emissions of NO_x and CO were very low during all test periods. NO_x emissions at full load averaged less than 0.04 ppmvd corrected to 15-percent O₂ and were even lower at the reduced power output settings. The average NO_x emission rate at full load, normalized to power output, was less than 1.64E-06 lb/kWh. Many of the test runs yielded NO_x concentrations below the sampling system detection limit of 0.02 ppmvd (this detection limit for NO_x is based on the highest analyzer calibration error measured during calibrations). Based on OTC-published emission factors, the measured SU1 system emission rate is well below the average rate for the NY ISO region. The emission reductions are further increased when transmission and distribution system losses are accounted for providing electricity to the end user.

Concentrations of CO were also very low during all test runs, ranging from an average of 0.13 ppmvd at 15-percent O₂ at full load to 0.19 ppmvd at 15-percent O₂ at the 2.5 kW power output setting. Corresponding CO emission rates averaged 4.18E-06 and 6.04E-06 lb/kWh.

Emissions of THC and CH₄ were much higher than the measured NO_x and CO levels, suggesting that the fuel reformer may not be 100-percent efficient. Concentrations of THC and CH₄ at full load averaged 476 and 465 ppmvd at 15-percent O₂, respectively. Concentrations at the other operating set points are similar. The CH₄ represents about 97.5 percent of the total hydrocarbon content in the exhaust gas, which is consistent with the natural gas fuel analyses (on average, CH₄ represents about 96.5 percent of the fuel-bound hydrocarbons). Emission rates for THC and CH₄ at full load averaged 0.0087 and 0.085 lb/kWh respectively as shown in the table.

Concentrations of CO₂ in the SU1 system exhaust gas ranged from a low of 3.31 percent at 2.5 kW to 4.77 percent at full load. These concentrations correspond to average CO₂ emission rates of 1.61 and 1.66 lb/kWh, respectively. The SU1 system CO₂ emission rate is about the same as the average rate for the NY ISO region as further discussed in the following section.

Table 2-7. SU1 Emissions During Controlled Test Periods

Run No.	Power Delivered (kW)	Exhaust Gas O ₂ (%)	CO Emissions			NO _x Emissions			THC Emissions			CH ₄ Emissions			CO ₂ Emissions		
			(ppm @ 15% O ₂)	(lb/hr)	(lb/kWh)	(ppm @ 15% O ₂)	(lb/hr)	(lb/kWh)	(ppm @ 15% O ₂)	(lb/hr)	(lb/kWh)	(ppm @ 15% O ₂)	(lb/hr)	(lb/kWh)	(%)	(lb/hr)	(lb/kWh)
1	3.91	12.65	0.0592	7.09E-06	1.82E-06	0.0206	4.06E-06	1.04E-06	460	0.0315	8.06E-03	458	0.0314	8.03E-03	4.61	6.22	1.59
2	3.92	12.88	0.0775	9.41E-06	2.40E-06	<0.0200	<1.82E-06	<4.65E-07	476	0.0330	8.42E-03	471	0.0327	8.33E-03	4.51	6.33	1.62
3	3.90	12.92	0.161	1.94E-05	4.99E-06	<0.0200	<2.28E-06	<5.83E-07	528	0.0365	9.38E-03	525	0.0363	9.32E-03	4.52	6.36	1.63
Avg.	3.91	12.82	0.0991	1.20E-05	3.07E-06	<0.0202	<2.72E-06	<6.96E-07	488	0.0337	8.62E-03	485	0.0334	8.56E-03	4.55	6.30	1.61
Std. Dev.	0.01	0.15	0.054	6.56E-06	1.69E-06	0.0004	1.18E-06	3.04E-07	35.8	0.0026	6.79E-04	35.8	0.0026	6.76E-04	0.056	0.075	0.021
4	2.58	14.92	0.154	1.23E-05	4.78E-06	<0.0200	<2.93E-06	<1.14E-06	500	0.0229	8.84E-03	484	0.0221	8.57E-03	3.35	4.16	1.61
5	2.59	14.92	0.170	1.37E-05	5.31E-06	0.0334	4.45E-06	1.72E-06	482	0.0223	8.63E-03	464	0.0215	8.29E-03	3.31	4.16	1.61
6	2.54	14.99	0.255	2.04E-05	8.02E-06	<0.0200	<2.40E-06	<9.44E-07	546	0.0249	9.81E-03	529	0.0241	9.51E-03	3.27	4.09	1.61
Avg.	2.57	14.94	0.193	1.55E-05	6.04E-06	<0.0245	<3.26E-06	<1.27E-06	509	0.0234	9.10E-03	492	0.0226	8.79E-03	3.31	4.14	1.61
Std. Dev.	0.03	0.04	0.054	4.28E-06	1.74E-06	0.0077	1.07E-06	4.04E-07	32.8	0.0013	6.29E-04	33.3	0.0014	6.36E-04	0.038	0.038	0.004
7	4.77	12.39	0.140	2.16E-05	4.54E-06	<0.0200	<3.99E-06	<8.36E-07	492	0.0434	9.11E-03	478	0.0422	8.85E-03	4.75	7.99	1.68
8	4.74	12.24	0.147	2.22E-05	4.69E-06	<0.0200	<3.54E-06	<7.47E-07	460	0.0398	8.39E-03	450	0.0389	8.20E-03	4.84	7.84	1.66
9	4.75	12.46	0.104	1.58E-05	3.32E-06	0.0637	1.59E-05	3.34E-06	478	0.0414	8.72E-03	468	0.0406	8.55E-03	4.73	7.89	1.66
Avg.	4.75	12.36	0.130	1.99E-05	4.18E-06	<0.0346	<7.80E-06	<1.64E-06	476	0.0415	8.74E-03	465	0.0406	8.54E-03	4.77	7.91	1.66
Std. Dev.	0.02	0.11	0.023	3.56E-06	7.48E-07	0.0252	7.00E-06	1.47E-06	16.2	0.0018	3.59E-04	14.6	0.0017	3.24E-04	0.059	0.074	0.010

2.3.2 Estimation of Annual Emission Reductions for the Lewiston Residence

The electricity generated by the SU1 system will offset electricity supplied by the utility grid. Section 1.4.5 states that annual emission reductions are estimated for the residence with two key assumptions: first, that the SU1 system is normally operated at a power setting of 2.5 kW and all power produced is consumed on site and second, that the unit will have a 74 percent availability rate (the availability rate observed during the verification period).

Table 2-8 summarizes the estimated reductions in NO_x and CO₂ emissions resulting from on-site electricity generation and use at the Lewiston residence. As shown in the table, electricity generation under the SU1 scenario (less power from the grid is used at the home) results in estimated annual NO_x emission reductions of 44.3 lb (or about 64 percent). The reductions are favorable for both ozone and non-ozone season periods because the emission rate for the NY ISO is significantly higher than the emission rate for the SU1.

Conversely, the CO₂ emission factors for the NY ISO are similar to the measured emission rate for the SU1. As such, CO₂ emissions reductions are estimated to be small when the SU1 system is operated for on-site generation. The reduction in power purchased from the grid results in an estimated emission reduction of about 723 lb CO₂ (or only about 1.7 percent). Being a fuel reforming rather than combustion type technology, some methane is emitted from the SU1 (Table 2-7). As such, when the contribution of methane to greenhouse gas emissions is considered, this version of the SU1 (without heat recovery capability) is essentially a greenhouse gas neutral technology.

Table 2-8. Emissions Offsets From On-Site Electricity Production

NY ISO Emission Rates (lb/kWh_e)

	NO _x	CO ₂
ozone wkday	0.0021	1.37
ozone night/wkend	0.0028	1.67
non-ozone wkday	0.0021	1.46
non-ozone night/wkend	0.0028	1.61

SU1 System System Emission Rates (lb/kWh_e)

	NO _x	CO ₂
Power Command of 2.5 kW	0.00000127	1.61

Emission Reduction Estimates From Electricity Production

	Baseline Scenario		SU1 System Scenario				Total Emissions lb	Emission Reductions lb
			Energy Supplied By SU1		Makeup Energy			
	Electricity From Grid kWh _e	Grid Emissions lb	Electricity From SU1 kWh _e	SU1 Emissions lb	Electricity From Grid kWh _e	Grid Emissions lb		
NO_x								
ozone season wkday	4,417	10.00	3,317	0.0042	3,317	2.49	2.49	7.50
ozone season night/wkend	4,877	14.72	3,666	0.0047	3,666	3.65	3.66	11.06
non-ozone season wkday	8,022	18.16	4,625	0.0059	4,625	7.69	7.70	10.46
non-ozone season night/wkend	8,723	26.33	5,051	0.0064	5,051	11.08	11.09	15.24
Annual Total	26,039	69.21	16,659	0.0212	16,659	24.92	24.94	44.27
CO₂								
ozone season wkday	4,417	6,523	3,317	5,340	3,317	1,625	6,964	(442)
ozone season night/wkend	4,877	8,780	3,666	5,903	3,666	2,180	8,083	698
non-ozone season wkday	8,022	12,626	4,625	7,446	4,625	5,347	12,793	(167)
non-ozone season night/wkend	8,723	15,139	5,051	8,132	5,051	6,373	14,505	634
Annual Total	26,039	43,068	16,659	26,821	16,659	15,524	42,345	723

3.0 DATA QUALITY ASSESSMENT

3.1 DATA QUALITY OBJECTIVES

The GHG Center selects methods and instruments for all verifications to ensure a stated level of data quality in the final results. The GHG Center specifies data quality objectives (DQOs) for each verification parameter before testing commences. Each test measurement that contributes to the determination of a verification parameter has stated data quality indicators (DQIs) which, if met, ensure achievement of that verification parameter's DQO.

The establishment of DQOs begins with the determination of the desired level of confidence in the verification parameters. The next step is to identify all measured values which affect the verification parameter and determine the levels of error which can be tolerated. The DQIs, most often stated in terms of measurement accuracy, precision, and completeness, are used to determine if the stated DQOs are satisfied. Table 3-1 summarizes the DQOs established in the test planning stage for each verification parameter. The actual data quality achieved during testing is also shown.

Table 3-1. Verification Parameter Data Quality Objectives

Verification Parameter	Original DQO Goal ^a Relative (%) / Absolute (units)	Achieved ^b Relative (%) / Absolute (units)
Power Production Performance		
Electrical power output (kW)	±1.5% / 0.08 kW	±1.5% / 0.07 kW
Electrical efficiency (%)	±1.9% / 0.48% ^c	±1.8% / 0.42% ^c
Power Quality Performance		
Electrical frequency (Hz)	±0.01% / 0.006 Hz	±0.01% / 0.006 Hz
Power factor (%)	±0.50% / 0.50%	±0.50% / 0.50%
Voltage and current total harmonic distortion (THD) (%)	±1.00% / 0.05%	±1.00% / 0.05%
Emissions Performance		
CO and NO _x concentration, dry (ppmvd)	±2.0% of span	±2.0% of span / 0.04 ppmvd NO _x , 0.20 ppmvd CO
CO ₂ concentration (%)	±2.0% of span	±0.85% of span / 0.17%
THC and CH ₄ concentration (ppmv)	±5.0% of span	±0.2% of span / 2.0 ppmv CH ₄ , ±3.5% span / 35 ppmv THC
CO ₂ , NO _x , and CO ₂ emission rates (lb/kWh)	±5.6% ^c	±2.6% ^c
THC and CH ₄ emission rates (lb/kWh)	±7.1% ^c	±3.9% ^c
^a Absolute errors based on anticipated values where applicable. ^b Absolute errors based on average values measured during full load testing. ^c Calculated composite error described in text.		

The DQIs, specified in Table 3-2, contain accuracy, precision, and completeness levels that must be achieved to ensure that DQOs can be met. Reconciliation of DQIs is conducted by performing independent performance checks in the field with certified reference materials and by following approved reference methods, factory calibrating the instruments prior to use, and conducting QA/QC procedures in the field to ensure that instrument installation and operation are verified. The following discussion illustrates that all DQI goals were achieved and all DQOs were met or exceeded for all verification parameters.

3.2 RECONCILIATION OF DQOs AND DQIs

Table 3-2 summarizes the range of measurements observed in the field and the completeness goals. Completeness is the number or percent of valid determinations actually made relative to the number or percent of determinations planned. The completeness goals for the controlled tests were to obtain 95 percent valid one-minute readings for electrical efficiency and emission rate data for three test runs conducted at each of three different load conditions. Completeness goals for the extended test period were to obtain valid data for 80 percent of the total number of days for power quality, power output, fuel input, and ambient measurements. These goals were exceeded and all of the one-minute average data points were validated for the entire verification period (although the unit was down for a total of 61 hours during the extended monitoring period).

Table 3-2 also includes accuracy goals for measurement instruments. Actual measurement accuracy achieved are also reported based on instrument calibrations conducted by manufacturers, field calibrations, reasonableness checks, and/or independent performance checks with a second instrument. Table 3-3 includes the QA/QC procedures that were conducted for key measurements in addition to the procedures used to establish DQIs. The accuracy results for each measurement and their effects on the DQOs are discussed below.

Table 3-2. Summary of Data Quality Goals and Results

Measurement Variable		Instrument Type / Manufacturer	Instrument Range	Range Observed in Field	Accuracy ^a			Completeness	
					Goal	Actual	How Verified / Determined	Goal	Actual
SU1 system Power Output and Quality	Power	Electric Meter/ Power Measurements 7600 ION	0 to 100 kW	2.2 to 4.9 kW	±1.50% reading ^b	±1.50% reading ^b	Instrument calibration from manufacturer prior to testing	Controlled tests: three valid runs per load meeting PTC 50 criteria	Controlled tests: three valid runs per load meeting PTC 50 criteria
	Voltage		0 to 600 V	116 to 124 V	±1.01% reading	±1.01% reading			
	Frequency		49 to 61 Hz	59.94 to 60.06 Hz	±0.01% reading	±0.01% reading			
	Current		0 to 100 A	9 to 21 A	±1.01% reading	±1.01% reading			
	Voltage THD		0 to 100%	2.12 to 8.63%	±1% FS ^c	±1% FS			
	Current THD		0 to 100%	1.45 to 94.54%	±1% FS	±1% FS			
	Power Factor		0 to 100%	99.594 to 99.976%	±0.5% reading	±0.5% reading			
Ambient Conditions	Ambient Temperature	RTD / Vaisala Model HMD 60YO	-50 to 150 °F	27 to 81 °F	±1.1 °F	±0.2 °F	Instrument calibration from manufacturer	Extended test: 80% of one- minute readings for entire period	Extended test: 74% of one-minute readings for ten days
	Ambient Pressure	Setra Model 280E	13.80 to 14.50 psia	14.34 to 14.64 psia	±1.0% FS	±0.05% FS			
	Relative Humidity	Vaisala Model HMD 60YO	0 to 100% RH	15 to 95% RH	± 3%	± 0.2%			

(continued)

Table 3-2. Summary of Data Quality Indicator Goals and Results (continued)

Measurement Variable		Instrument Type / Manufacturer	Instrument Range	Measurement Range Observed	Accuracy			Completeness	
					Goal	Actual	How Verified / Determined	Goal	Actual
Fuel Input	Gas Flow Rate	Diaphragm Gas Meter / Rockwell Invensys R-200	0 to 200 acfh	0 to 82.3 acfh	1.0% of reading	±0.24% of reading	Factory calibration against NIST traceable volume prover	Controlled tests: three valid runs per load meeting PTC 50 criteria	Controlled tests: three valid runs per load meeting PTC 50 criteria
	Gas Pressure	Pressure Transducer / Rosemount Model 3051	-100 to 100 in. w.c.	0.6 to 9.1 in. w.c.	±0.75% FS	±0.75% FS			
	Gas Temperature	RTD / Rosemount Series 68	-58 to 752 °F	28 to 78 °F	±0.10% reading	±0.09% reading	Instrument calibration from manufacturer prior to testing	Extended test: 80% of one-minute readings for entire period	Extended test: 23% of one-minute readings for ten days
	LHV	Gas Chromatograph / HP 589011	0 to 100% CH ₄	92 to 95% CH ₄	±3.0% for CH ₄ concentration	±0.48% for CH ₄ concentration			
920 to 925 Btu/ft ³				± 0.2% repeatability for LHV	± 0.01% repeatability for LHV	Conducted duplicate analyses on 3 samples			
Exhaust Stack Emissions	NO _x Levels	Chemiluminescent/ TEI Model 10	0 to 2 ppmvd	0 to 0.06 ppmvd	± 2% FS or ± 0.04 ppmvd	≤ 2.05% FS or ± 0.04 ppmvd ^d	Calculated following EPA Reference Method calibrations (before and after each test run)	Controlled tests: three valid runs per load	Controlled tests: three valid runs per load
	CO Levels	NDIR / TEI Model 48	0 to 10 ppmvd	0 to 0.23 ppmvd	± 2% FS or ± 0.2 ppmvd	≤ 1.68% FS or ± 0.17 ppmvd ^d			
	CO ₂ Levels	NDIR / Servomex Model 1440	0 to 20%	3.3 to 4.9%	± 2% FS or ± 0.4%	≤ 1.18% FS or ± 0.23% ^d			
	O ₂ Levels	NDIR / Servomex Model 1440	0 to 25%	12 to 15%	± 2% FS or ± 0.5%	≤ 0.69% FS or ± 0.17% ^d			
	CH ₄ and THC Levels	GC/FID / HP Model 5890	0 to 1,000 ppmv	0 to 710 ppmvd	± 5% repeatability	0.7% CH ₄ 0.9% THC	Conducted duplicate analyses on 2 samples		

^a Accuracy goal represents the maximum error expected at the operating range. It is defined as the sum of instrument and sampling errors.
^b Includes instrument, 1.0% current transformer (CT), and 1.0% potential transformer (PT) errors.
^c FS: full scale
^d Values represent the maximum system error observed throughout the controlled test periods.

3.2.1 Power Output

Instrumentation used to measure power was introduced in Section 1.0 and included a Power Measurements Model 7600 ION. The data quality objective for power output is ± 1.5 percent of reading, which is lower than the typical uncertainty set forth in PTC-50 of 1.8 percent. The Test Plan specified factory calibration of the ION 7600 with a NIST-traceable standard to determine if the power output DQO was met. The Test Plan also required the GHG Center to perform several reasonableness checks in the field to ensure that the meter was installed and operating properly. The following summarizes the results.

The meter was factory-calibrated by Power Measurements less than one year prior to being used at the test site. Calibrations were conducted in accordance with Power Measurements strict standard operating procedures (in compliance with ISO 9002:1994) and are traceable to NIST standards. The meter was certified by Power Measurements to meet or exceed the accuracy values summarized in Table 3-2 for power output, voltage, current, and frequency. NIST-traceable calibration records are archived by the GHG Center. Pretest factory calibrations on the meter indicated that its accuracy was within ± 0.05 percent of reading and this value, combined with the 1.0 percent error inherent to the current and potential transformers, met the ± 1.5 percent DQO. The manufacturer-certified calibration results and the average power output measured at full load showed the maximum error during all testing to be ± 0.07 kW.

Additional QC checks were performed in the field to verify the operation of the electrical meter after installation of the meters at the site and prior to the start of the verification test. The results of these QC checks (summarized in Table 3-3) are not used to reconcile the DQI goals, but to document proper operation in the field. Current and voltage readings were checked for reasonableness using a hand-held Fluke Multimeter. These checks confirmed that the voltage and current readings between the 7600 ION and the Fluke were within the range specified in the Test Plan as shown in Table 3-3.

These results show that the 7600 ION was installed and operating properly during the verification test. The ± 1.5 percent error in power measurements, as certified by the manufacturer, was used to reconcile the power output DQO (discussed above) and the electrical efficiency DQO (discussed in Section 3.2.2).

Table 3-3. Results of Additional QA/QC Checks

Measurement Variable	QA/QC Check	When Performed/Frequency	Expected or Allowable Result	Results Achieved
Power Output	Sensor Diagnostics in Field	Beginning and end of test	Voltage within $\pm 2.01\%$ and current within $\pm 3.01\%$ reading	$\pm 0.43\%$ voltage $\pm 1.2\%$ current
	Reasonableness checks	Throughout test	Readings should be between 4.5 and 5.0 kW at full load	Readings were 4.7 to 4.8 kW
Fuel Flow Rate	Reasonableness Check	Beginning of test	Manual gas reading within $\pm 7.34\%$ of DAS reading	Manual gas reading was within $\pm 5.6\%$ of DAS reading
Fuel Heating Value	Duplicate analyses performed by laboratory	At least two samples and the blind audit sample	Refer to Table 3-5 and 3-6	Results satisfactory, see Section 3.2.2.3
	Calibration with gas standards by laboratory	Prior to analysis of each lot of samples submitted	$\pm 1.0\%$ for each gas constituent	
	Independent performance check with blind audit sample	One time during test period	$\pm 3.0\%$ for each gas constituent	

3.2.2 Electrical Efficiency

The DQO for electrical efficiency was to achieve an uncertainty of ± 1.9 percent at full electrical load or less. Recall from Equation 1 (Section 1.4.1) that the electrical efficiency determination consists of three direct measurements: (1) power output, (2) fuel flow rate, and (3) fuel LHV. The accuracy goals specified to meet the electrical efficiency DQO consisted of ± 1.5 percent for power output, ± 1.0 percent for fuel flow rate (in units of scfh), and ± 0.2 percent for LHV. The accuracy goals for each measurement were met and, in some cases they were exceeded. Table 3-4 demonstrates the propagation of the measurement errors (detailed procedures for error propagation are provided in the Test Plan). The table shows that the overall relative error in electrical efficiency was 1.8 percent (0.42 percent absolute). The paragraphs following Table 3-4 summarize actual errors achieved and the methods used to compute them.

Power Output: As discussed in Section 3.2.1, factory calibrations of the 7600 ION with a NIST-traceable standard and the inherent error in the current and potential transformers resulted in ± 1.50 percent error in power measurements. Reasonableness checks in the field verified that the meter was functioning properly. The average power output at full load was measured to be 4.75 kW, and the measurement error is determined to be ± 0.07 kW.

Heat Input: Heat input is the product of measured fuel flow rate and LHV. The DQI goal for fuel flow rate was reconciled through calibration of the gas meter with a NIST-traceable volume prover and factory calibration of the gas pressure and temperature sensors used to correct meter readings from units of acfh to scfh. The gas meter had an average NIST-traceable accuracy of ± 0.24 percent over a four point calibration. NIST-traceable factory calibrations for the gas pressure and temperature sensors indicate that the corresponding accuracy criteria were met as shown in Table 3-4.

Table 3-4. Electrical Efficiency Error Propagation			
Contributing Measurements		Absolute Error^a	Relative Error (%)
Fuel flow rate at standard conditions, V, requires Equation 2 and these measurements	Actual fuel flow rate, V _g	0.17 acfh	0.24
	Fuel gas pressure, P _g	0.11 psia	0.75
	Fuel gas temperature, T _g	0.46 °R	0.09
	Fuel gas compressibility factor at standard conditions, Z _{std}	0.00200	0.20
	Fuel gas compressibility factor at actual conditions, Z _g	0.00200	0.20
	Eqn. 2 result:	0.62 scfh (73.55*0.0084)	0.84
Heat input, HI, requires Equation 3, this measurement, and the Equation 2 result	LHV, Btu/scf	1.8 Btu/scf	0.20
	Eqn. 3 result:	639.2 Btu/hr (68,001*0.0094)	0.94
Electrical Efficiency, η _e , requires Equation 1, this measurement, and the Equation 3 result	Power Output, kW	0.07 kW	1.50
	Eqn. 1 result:	0.421% (23.8*0.0177)	1.77
^a Errors are based on the average values measured during full load controlled test periods to provide maximum absolute error.			

The Test Plan specified using the results of analysis of a blind audit gas and duplicate analysis to reconcile the accuracy of LHV determination. The primary gas composition DQI is the accuracy of the methane portion of the blind audit sample (methane represents about 95 percent of the gas composition). Methane results of the blind audit sample were within 0.5 percent of the certified concentration. The percent difference between the original and duplicate analyses was ±0.03 percent (Section 3.2.2.3). Therefore such, the LHV goal of ±0.2 percent was met. The average LHV was verified to be 925 Btu/ft³, and the measurement error corresponding to this heating value is ±1.8 Btu/ft³. The heat input compounded error is then calculate as illustrated in Table 3-4. The measurement error amounts to approximately ±639 Btu/hr, or 0.94 percent relative error at the average measured heat input of 68.00 MBtu/hr.

3.2.2.1 PTC-50 Requirements for Electrical Efficiency Determination

PTC-50 guidelines for efficiency determinations were performed during time intervals that were 60 minutes in duration. Table 3-5 summarizes the maximum permissible variations observed in power output, power factor, fuel flow rate, barometric pressure, and ambient temperature during each test run. The requirements for all parameters other than fuel flow rate were met for all test runs. The fuel flow rate variability criteria were exceeded during all three low load tests (2.5 kW power command testing). The variability criteria were met during all the other tests where gas flow rates were higher, indicating that the variability is most likely not related to fuel cell operations. More likely, the variabilities are a function of meter operations. Specifically, the meter uses a pulse counter to generate an electronic signal that is recordable. The meter generates a voltage pulse for every 0.01 actual cubic feet of gas passing through the meter (which correlates to time intervals of approximately 1 pulse per second at low load). The lower the gas flow rate is, the poorer the resolution of the measurement (less pulses per unit of time). In principle, the pulse rate should add a minute-to-minute count variation of about 1.7 percent, which should

decrease for longer averaging periods. In addition, the flow data seems to show fluctuations (apparent rate fluctuations on the order of 4 scfh peak to valley) over slightly longer periods, such as 5 to 7 minutes. The variability in the gas flow rate measurement is roughly consistent for all conditions, and therefore relatively more significant at the lower flow rates, even though there is essentially no longer-term drift in the gas flow rate during this load test period. Review of the data collected indicate that at no point during the low load testing could the ± 5 percent criteria for flow rate variation be met for 1-minute data. If the criterion is applied to three minute average flow rates, all load test runs fall within the criterion.

Table 3-5. Variability Observed in Operating Conditions					
	Maximum Observed Variation^a in Measured Parameters				
	Power Output (%)	Fuel Flow Rate (%)	Fuel Gas Press. (%)	Barometric Press. (%)	Inlet Air Temp. (°F)
Maximum Allowable Variation	± 5.0	± 5.0	± 1.0	± 0.5	± 4
Run 1	2.5	5.0	0.09	0.02	2.1
Run 2	1.5	4.6	0.05	0.04	1.2
Run 3	1.5	3.9	0.04	0.05	1.1
Run 4	3.5	5.3	0.06	0.02	3.0
Run 5	3.8	7.3	0.02	0.03	0.8
Run 6	4.7	6.5	0.02	0.03	1.4
Run 7	1.4	4.7	0.05	0.04	1.1
Run 8	1.7	3.9	0.02	0.02	1.9
Run 9	0.9	4.0	0.02	0.01	1.8

^a Maximum (Average of Test Run – Observed Value) / Average of Test Run * 100

3.2.2.2 Ambient Measurements

Ambient temperature, relative humidity, and barometric pressure at the site were monitored throughout the extended verification period and the controlled tests. The instrumentation used is identified in Table 3-2 along with instrument ranges, data quality goals, and data quality achieved. All three sensors were factory calibrated prior to the verification testing using reference materials traceable to NIST standards. Results of these calibrations indicate that the ± 1.1 °F accuracy goal for temperature, ± 0.1 percent for pressure, and ± 3 percent for relative humidity were met.

3.2.2.3 Fuel Lower Heating Value

A total of six fuel gas samples were collected during the verification. Full documentation of sample collection date, time, run number, and canister ID were logged along with laboratory chain of custody forms and were shipped along with the samples. Copies of the chain of custody forms and results of the analyses are stored in the GHG Center project files. Collected samples were shipped to Empact Analytical of Brighton, CO, for compositional analysis and determination of LHV per ASTM test methods D1945 and D3588, respectively. A total of four valid samples were collected and analyzed during the controlled test periods and two at the conclusion of the ten-day extended monitoring period. The DQI goals were to measure methane concentration that was within ± 3.0 percent of a NIST-traceable calibration gas and a certified audit gas and to achieve less than ± 0.2 percent difference in LHV duplicate analyses results.

The GC/FID was calibrated daily using a continuous calibration verification standard (NIST-traceable) and upper and lower control limits maintained by Empact. Copies of the GC/FID calibration records are maintained at the GHG Center and indicate that instrument responses were well within the control limits for all analyses conducted. A certified natural gas audit sample was submitted to Empact along with the samples and its results were reviewed to determine analytical error and repeatability for major gas components. This sample represents a performance evaluation audit (PEA). Results of the audit sample, summarized in Table 3-6, show acceptable accuracy for major gas components. High levels of error were evident only on components that are not hydrocarbons (nitrogen and carbon dioxide). The results also show that the ± 3.0 percent goal for methane concentration was achieved (result was $\pm 0.5\%$).

Table 3-6. Results of Natural Gas Audit Sample Analysis

Gas Component	Certified Component Conc. (%)	Initial Analytical Result (%)	Duplicate Analytical Result (%)	Combined Sampling and Analytical Error (%) ^a	Analytical Repeatability (%) ^b
Nitrogen	5.00	5.14	5.13	2.80	0.19
Carbon dioxide	1.01	0.98	0.98	2.97	0.00
Methane	70.41	70.07	70.05	0.48	0.03
Ethane	9.01	9.10	9.13	1.00	0.33
Propane	6.03	6.07	6.07	0.66	0.00
n-butane	3.01	3.03	3.03	0.66	0.00
Iso-butane	3.01	3.03	3.03	0.66	0.00
Iso-pentane	1.01	1.00	1.00	0.99	0.00
n-pentane	1.01	1.02	1.01	0.99	0.98

^a Calculated as: Error = (certified conc. – initial analytical result) / certified conc. * 100
^b Calculated as: Repeatability = (Initial result - Duplicate result) / Initial result * 100

Duplicate analyses were conducted on two of the samples collected during the verification period and the blind audit sample shown above. Duplicate analysis is defined as the analyses performed by the same operating procedure and using the same instrument for a given sample volume. Results of the duplicate analyses showed an average analytical repeatability of 0.01 percent for methane and 0.02 percent for LHV. The results demonstrate that the ± 0.2 percent LHV accuracy goal was achieved.

3.2.3 Exhaust Stack Emission Measurements

EPA reference methods were used to quantify emission rates of NO_x, CO, THCs, CH₄, and CO₂. The reference methods specify the sampling and calibration procedures and data quality checks that must be followed to collect data that meets the methods' required performance objectives. These methods ensure that run-specific quantification of instrument and sampling system drift and accuracy occur throughout the emissions tests. The methods and calibration procedures for this verification were modified slightly to allow for measurement of low level pollutants. The DQOs specified in the Test Plan were based on the requirements of the reference methods and the low level modifications. Specifically, the requirements included overall accuracies of ± 40 ppbd for NO_x ($\pm 2\%$ full-scale), ± 200 ppbd for CO ($\pm 2\%$ full-scale), ± 1.00 ppmvd for THC and CH₄, and ± 0.4 percent for CO₂ and O₂. The data quality indicator goals required to meet the DQO consisted of an assessment of sampling system error (bias) and drift for NO_x, CO, CO₂, and O₂, and an assessment of calibration error and spike and recovery analyses for THC and CH₄.

Certain emissions testing sampling and analytical procedures were used that deviated from the procedures proposed in the Test Plan, including the following:

As explained in Section 1.4.4, Reference Method 19 F-factor procedures were used to convert measured pollutant concentrations to mass emissions. This approach was preferred over the procedures specified in the Test Plan (Reference Method 2C) because it provided better accuracy at the very low exhaust gas flow rates encountered.

Due to failure of the on-site GC/FID analyzer, alternative procedures were used to quantify THC and CH₄ concentrations. Specifically, EPA Method 18 Bag Sampling Procedure with GC/FID analysis was used – Method 18 is widely accepted for determination of both parameters and all of the QA/QC criteria stated in the method were followed and satisfied. This change is not expected to impact the overall data quality for determination of THC and CH₄ concentrations, especially since measured concentrations were much higher than anticipated during test planning.

The Test Plan specified speciation of NO_x emissions with determination of NO and NO₂ concentrations separately. This could not be performed during the verification because the NO_x analyzer selected for the test did not have this capability (Horiba Model CLA-510SS). This analyzer was selected at the recommendation of several peer reviewers as being the least susceptible to CO₂ quenching. Selection of this analyzer did however compromise the GHG Center's ability to evaluate NO₂ scrubbing due to the presence of moisture in the exhaust gas. The "Standard Addition Procedure" planned to evaluate the accuracy of exhaust gas flow rate measurements (Method 2C) was also intended to be used to examine NO₂ losses due to scrubbing by exhaust gas moisture. Since the use of Method 2C was replaced in favor of Method 19 procedures for emission rate determination, and the use of the Horiba analyzer precluded speciation of NO₂, the "Standard Addition Procedure" testing was not conducted. A true evaluation of possible NO₂ losses due to scrubbing was therefore not conducted. It is possible that some loss of NO₂ did occur during testing because moisture content was high (the exhaust gas was saturated).

The GHG Center has not located any reliable data that defines the significance of NO₂ in the overall NO_x concentrations in PEM fuel cell exhausts. The NO₂ to NO_x ratio is very small with most combustion type sources. It is highly likely that NO is the primary NO_x species in the exhaust gas and that NO₂ bias was very small. Furthermore, the GHG Center took special precautions in sampling system design to minimize the contact of condensed moisture and flue gas. Specifically, sampling system flow rates were maintained at only 3 lpm, and the heated sample line carrying gases to the moisture removal system was only two feet long. Since it was not possible to document the bias that may have occurred in the NO_x measurements, reported NO_x concentrations and emission rates may be lower than actual. However, the NO_x concentrations are still believed to be in the range of 0 to 40 ppb. Note that the "Standard Addition Procedure" was not the primary DQI for NO_x measurements. System accuracy is defined using the system bias calibrations that were conducted in accordance with the EPA reference methods used here.

Analyzer Calibrations and Sampling System Bias Checks

Analyzer calibrations were conducted to verify the error in NO_x, CO, CO₂, and O₂ measurements relative to EPA Protocol 1 certified calibration gas standards. The calibration error test was conducted at the beginning of each day of controlled test periods. A suite of calibration gases was introduced directly to each analyzer and analyzer responses were recorded. A dilution system was used in accordance with EPA Method 205 to dilute the certified NO_x and CO gases to the low range levels used. Three calibration gas mixtures were used for NO_x, CO₂ and O₂: (1) zero, (2) 40 to 60 percent of span, and (3) 80 to 100 percent of span. Four gases were used for CO: zero and approximately 30, 60, and 90 percent of span. The analyzer calibration errors for all gases were below the allowable levels as shown in Table 3-7.

Zero and mid-level calibration gases were introduced to the sampling system at the probe before and after each test run, and the response was recorded. System bias was calculated by comparing the system

responses to the calibration error responses recorded earlier. Table 3-2, the system bias goal for all gases was achieved: ± 0.04 ppmvd for NO_x , ± 0.20 ppmvd for CO, ± 0.17 percent (absolute) for CO_2 , and ± 0.17 percent (absolute) for O_2 . Consequently, the DQO was satisfied.

The pre- and post-test system bias calibrations were also used to calculate sampling system drift for each pollutant. Table 3-7 shows that the maximum drift measured was 2.0 percent of span for NO_x , 1.3 percent of span for CO, 0.5 percent for CO_2 , and 0.6 percent for O_2 . Therefore, the drift goals were also met for all pollutants. Results of each of the analyzer and sampling system calibrations conducted, including linearity tests and sampling system bias and drift checks, are presented in Appendix A.

The NO_x analyzer converts any NO_2 present in the gas stream to NO prior to gas analysis. A NO_2 to NO converter QC check consisted of determining NO_2 converter efficiency prior to beginning of emissions testing. This was done by introducing to the analyzer a mixture of mid-level calibration gas and air. The analyzer response was recorded every minute for 30 minutes. The response will be stable at the highest peak value observed if the NO_2 to NO conversion is 100 percent efficient. The converter is faulty and the analyzer must be either repaired or replaced prior to testing if the response decreases by more than 2 percent from the peak value observed during the 30-minute test period. The converter efficiency was measured to be 100 percent as shown in Table 3-7.

The Test Plan specified calibration of the GC/FID with a certified gas standard for THC and CH_4 and duplicate analyses of each sample as the means to evaluate accuracy. Instrument calibrations were properly performed (results are in Table 3-7), but the duplicate analyses were conducted on only two of the samples due to incorrect analytical instructions on the sample chain-of-custody form. Results of the duplicate analyses, shown in Table 3-2, indicate analytical repeatability for CH_4 and THC of 0.7 and 0.9 percent, respectively. A better evaluation of sampling and analytical error uses a sample spike and recovery analysis. This was conducted and is used as the primary data quality indicator for these pollutants. A bag is spiked with a known concentration of methane and several other hydrocarbons and then analyzed using the same instrumentation, procedures, and personnel as the samples. The results of this test (99.8 percent recovery for CH_4 and 96.5 percent recovery for THC) are used in the error propagation for overall error in CH_4 and THC emission rates.

Table 3-7. Additional QA/QC Checks for Emissions Testing

Parameter	QA/QC Check	When Performed/Frequency	Expected or Allowable Result	Maximum Results Measured ^a
NO_x	NO_2 converter efficiency	Once before testing begins	98% efficiency or greater	100.0%
NO_x , CO, CO_2 , O_2	Analyzer calibration error test	Daily before testing	$\pm 2\%$ of analyzer span or less	NO_x : 1.00% of span, or 0.02 ppmvd CO: 1.42% of span or 0.14 ppmvd CO_2 : 0.32% of span or 0.06% absolute O_2 : 0.41% of span or 0.10% absolute
	Calibration drift test	After each test	$\pm 3\%$ of analyzer span or less	NO_x : 1.8% of span, or 0.04 ppmvd CO: 1.3% of span or 0.13 ppmvd CO_2 : 0.5% of span or 0.10% absolute O_2 : 0.7% of span or 0.19% absolute
THC and CH_4	GC/FID calibration error test	Once before analyses	$\pm 5\%$ repeatability	3.9% for CH_4 , 4.1% for THC
	Spike and recovery test		$\pm 95\%$ recovery of known spike value	99.8% for CH_4 , 96.5% for THC

^a See Appendix A for individual test run results

Determination of Error in Emission Rate Determinations

The Test Plan specified an emission rate DQO for NO_x, CO, and CO₂ collectively of 5.4 percent relative error and a THC and CH₄ DQO of 7.1 percent relative error. These DQOs were developed based on errors in pollutant concentration, SU1 power output, and exhaust gas flow rate measured using Reference Method 2C procedures. Reconciliation of the DQOs however, is based on the preferred Reference Method 19 used here. This revised approach is consistent with other emission rate verifications conducted by the GHG Center, and improves the overall accuracy of the determinations.

Error in determination of emission rates in units of lb/kWh is then derived from the errors in each of the contributing measurements in the F-factor procedure including pollutant concentrations, oxygen concentrations, system heat input (natural gas consumption rate and LHV), and power output. The highest concentration error in the NO_x, CO, and CO₂ measurements was 2.0 percent of full scale, and the error in THC and CH₄ concentration measurements was 3.5 percent of reading. Compounding these errors with the errors in oxygen content (0.69 percent), heat input (0.24 percent), and the power output error (1.5 percent), the emission rate compounded error is then computed as shown in the following equation:

$$\text{Error in Emission Rates} = \sqrt{(0.020)^2 + (0.0069)^2 + (0.0024)^2 + (0.0150)^2} = 0.0260 \quad (\text{Eqn. 6})$$

The highest error in NO_x, CO, and CO₂ emission rate determinations is then 2.60 percent, which meets the DQO. The error in THC and CH₄ emission rates is 3.88 percent, well within the goals set for emission rate determinations.

(this page intentionally left blank)

4.0 REFERENCES

- (1) American National Standards Institute, ANSI / Institute of Electrical and Electronics Engineers, *IEEE, Master Test Guide for Electrical Measurements in Power Circuits*, ANSI/IEEE Std. 120-1989, New York, NY. October. 1989.
- (2) American National Standards Institute, ANSI / Institute of Electrical and Electronics Engineers, *IEEE, Recommended Practices and Requirements for Harmonic Control in Electrical Power Systems*, IEEE Std. 519-1992, New York, NY. April. 1993.
- (3) American Society of Mechanical Engineers, *Performance Test Code: Fuel Cell Power Systems, ASTM PTC-50*, New York, NY. 2002.
- (4) American Society for Testing and Materials, Standard Test Method for Analysis of Natural Gas by Gas Chromatography, ASTM D1945-9GRI, West Conshohocken, PA. 2001.
- (5) American Society for Testing and Materials, Standard Practice for Calculating Heat Value, Compressibility factor, and Relative Density of Gaseous Fuels, ASTM D3588-98. West Conshohocken, PA. 2001.
- (6) IBACOS, Inc., "*On-site Power Generation — Advanced System Performance Report*," Report to US DOE and NREL. May 2002.
- (7) Southern Research Institute, Test and Quality Assurance Plan for Residential Electric Power Generation Using the Plug Power SU1 Fuel Cell System, SRI/USEPA-GHG-QAP-25, www.sri-rti.com, Greenhouse Gas Technology Center, Southern Research Institute, Research Triangle Park, NC. March 2003.
- (8) USEPA, Code of Federal Regulations, Title 40, Part 60, *New Source Performance Standards, Appendix A*, U.S. Environmental Protection Agency. Washington, DC. 1999.

APPENDIX A

Emissions Testing QA/QC Results

Appendix A-1.	Summary of Daily Reference Method Calibration Error Determinations	A-2
Appendix A-2.	Summary of Reference Method System Bias and Drift Checks.....	A-3

Appendix A-1 presents instrument calibration error and linearity checks for each of the analyzers used for emissions testing. These calibrations are conducted once at the beginning of each day of testing and after any changes or adjustments to the sampling system are conducted (changing analyzer range, for example). All of the calibration error results are within the specifications of the reference methods.

Appendix A-2 summarizes the system bias and drift checks conducted on the sampling system for each pollutant quantified. These system calibrations are conducted before and after each test run. Results of all of the calibrations are within the specifications of the reference methods.

APPENDIX A-1

Summary of Daily Reference Method Calibration Error Determination

Date	Gas	Measurement Range	Cal Gas Value	Analyzer Response	Absolute Difference	Calibration Error (% of Span) ^a
		(ppm for NO _x and CO; % for O ₂ and CO ₂)				
4/10/03 (Runs 1 - 3)	NO _x	2	0.000	0.005	0.005	0.25
			1.000	0.998	0.002	0.10
			1.600	1.610	0.010	0.50
	CO	10	0.00	-0.01	0.01	0.10
			3.00	3.10	0.10	1.02
			6.00	6.06	0.06	0.64
			9.00	9.07	0.07	0.70
	CO ₂	20	0.00	0.06	0.06	0.32
			9.16	9.15	0.01	0.05
			17.80	17.74	0.06	0.30
	O ₂	25	0.00	0.00	0.00	0.00
			11.06	11.06	0.00	0.00
21.00			21.03	0.03	0.12	
4/11/03 (Runs 4 - 9)	NO _x	2	0.000	0.005	0.005	0.25
			1.000	1.016	0.016	0.80
			1.600	1.580	0.020	1.00
	CO	10	0.00	0.04	0.04	0.37
			3.00	3.14	0.14	1.42
			6.00	5.89	0.11	1.10
			9.00	8.97	0.03	0.30
	CO ₂	20	0.00	0.06	0.06	0.28
			9.16	9.22	0.06	0.28
			17.80	17.80	0.00	0.02
	O ₂	25	0.00	0.03	0.03	0.12
			11.06	11.10	0.04	0.17
21.00			20.90	0.10	0.41	

^a Allowable calibration error is 2% of span.

Appendix A-2. Summary of Reference Method System Bias and Drift Checks

Analyzer Spans: NO_x = 2 ppm, CO = 10 ppm, CO₂ = 20%, O₂ = 25%

	Initial Cal 4/10/03	Run Number			Initial Cal 4/11/03	4	5	6	7	8	9
		1	2	3							
NO_x Zero											
System Response (ppm)	0.030	0.010	0.009	0.004	0.009	0.004	0.005	0.008	0.004	0.001	0.007
0.005 System Bias (% span)	1.23	0.25	0.19	-0.04	0.19	-0.05	-0.02	0.15	-0.07	-0.18	0.12
0.005 Drift (% span)	na	1.97	0.11	0.46	na	0.24	0.03	0.17	0.22	0.12	0.30
NO_x Mid											
System Response (ppm)	1.013	1.003	1.039	1.009	0.992	1.013	0.997	1.006	1.006	1.000	0.998
1.00 System Bias (% span)	0.74	0.27	2.05	0.52	-1.42	-0.33	-1.18	-0.70	-0.71	-0.98	-1.13
1.02 Drift (% span)	na	0.48	1.78	1.53	na	1.09	0.84	0.47	0.01	0.27	0.14
CO Zero											
System Response (ppm)	0.01	0.08	-0.02	-0.03	0.02	0.08	0.06	-0.05	-0.05	0.02	0.06
-0.01 System Bias (% span)	0.17	0.91	-0.06	-0.24	-0.15	0.45	0.17	-0.94	-0.94	-0.17	0.20
0.04 Drift (% span)	na	0.74	0.97	0.18	na	0.60	0.28	1.11	0.00	0.77	0.37
CO Mid											
System Response (ppm)	6.12	6.15	6.02	6.07	6.03	5.98	6.04	6.06	6.06	6.06	6.03
6.06 System Bias (% span)	0.52	0.81	-0.44	0.06	1.38	0.86	1.45	1.67	1.67	1.68	1.38
5.89 Drift (% span)	na	0.29	1.25	0.50	na	0.52	0.59	0.22	0.00	0.01	0.30
CO₂ Zero											
System Response (ppm)	0.11	0.10	0.11	0.11	0.06	0.10	0.04	0.03	0.06	0.04	0.13
0.06 System Bias (% span)	0.22	0.17	0.24	0.22	-0.04	0.20	-0.12	-0.15	-0.02	-0.13	0.35
0.06 Drift (% span)	na	0.04	0.07	0.03	na	0.24	0.32	0.03	0.13	0.11	0.48
CO₂ Mid											
System Response (ppm)	9.15	9.17	9.06	9.07	9.22	9.12	9.08	9.13	9.07	9.05	8.98
9.15 System Bias (% span)	-0.02	0.08	-0.45	-0.40	0.33	-0.13	-0.36	-0.13	-0.40	-0.53	-0.85
9.22 Drift (% span)	na	0.10	0.53	0.04	na	0.46	0.23	0.23	0.27	0.13	0.32
O₂ Zero											
System Response (ppm)	0.05	0.10	0.09	0.08	0.05	0.01	0.02	-0.02	0.16	-0.01	0.14
0.00 System Bias (% span)	0.18	0.40	0.36	0.33	0.08	-0.06	-0.04	-0.22	0.53	-0.14	0.44
0.029 Drift (% span)	na	0.22	0.04	0.02	na	0.13	0.02	0.18	0.75	0.67	0.57
O₂ Mid											
System Response (ppm)	11.14	11.08	11.04	11.08	11.01	10.99	11.01	10.97	10.94	10.95	10.93
11.06 System Bias (% span)	0.33	0.09	-0.09	0.08	-0.38	-0.44	-0.37	-0.54	-0.64	-0.59	-0.69
11.10 Drift (% span)	na	0.23	0.18	0.17	na	0.06	0.07	0.16	0.10	0.04	0.10

Allowable system bias is 5% span, allowable drift is 3% span.

APPENDIX B-1

Estimation of Regional Grid Emissions

EPA has recognized that clean energy technologies have the potential for significant emission reductions through displaced generation. However, a robust and analytically sound method to quantify the potential of displaced emissions has yet to be developed. Displaced generation is defined as the total electrical output (measured in kWh) from conventional electricity sources that is either displaced by or avoided through the implementation of energy-efficient measures. Displaced emissions are defined as the change in emissions (measured in lb) that results when conventional electrical generation is displaced by energy-efficient measures. On-site power generation with a distributed energy technology (e.g., SU1) is an example of a clean energy source, provided its emissions are less than conventional sources. DG-CHP systems can result in displaced generation and, ultimately, can displace emissions.

Several different methods have been developed and employed by various organizations to estimate emissions displaced by on-site electricity generation. Although there are many variations of such methodologies, they are all derived from the average emission rate method, the marginal-unit method, or historical emissions/generation data.

The average emission rate method uses the average emission rates for electricity generating units in a particular region or nationally. It is usually based on the average emission characteristics of all electricity-generating units or fossil-fired units only, and is often derived from historic generation and emissions data or projections of future generation and fuel use patterns. This approach is most widely used due to its simplicity and wide availability of average rates for many U.S. regions. The disadvantage of this method is that regional or national emission rate averages are not likely representative of the actual emission rate associated with the specific generating unit from which the emissions are displaced by energy-efficient measures. As a result, estimates of emissions impacts can be inaccurate and may not adequately reflect the realities of power markets.

The marginal-unit method is an attempt to improve on the average emission rate approach by identifying a particular unit or type of unit that may be displaced. Similar to the average emission rate method, the average emission characteristics of the displaced units are applied to generating reductions (via on-site generation) to estimate displaced emissions. The marginal-unit method assumes that at any point in time the marginal unit, by virtue of being the most expensive generating unit to operate, will be the unit that is displaced by the more efficient technology. Although this approach conceptually appears to be more reasonable than simply using a regional average emission rate, identifying the marginal unit is difficult, particularly in regions with large and frequent variations in hourly electricity demand.

Displaced emissions are also estimated using statistical techniques based on historical data. This approach seeks to forecast how displaced emissions arise from observed changes in electricity demand/supply instead of identifying the average or marginal emission rate of particular units. This approach requires statistical modeling, and data such as regional generation, emissions, and electricity demand. Its primary limitation is that actual site-specific and electricity control area specific data must be available.

EPA has been developing a newer approach that utilizes region/time specific parameters to represent average displaced emission rate (ADER). The ADER methodology accounts for the complexities of electricity markets in assessing how displaced emissions result from changes in electric demand or supply and produces regional, national, short-term, and long-term estimates of displaced emissions of CO₂, NO_x, SO₂, and mercury (Hg) from electric generation. The results of the ADER analysis are not currently available; as such, the GHG Center is unable to apply this methodology for this verification. However, at the suggestion of the EPA project officer leading this effort, a similar approach developed by the Ozone Transport Commission (OTC) has been adopted for this verification to estimate displaced emissions and is described below.

OTC is a multi-state organization focused on developing regional solutions to the ground-level ozone problem in the Northeast and Mid-Atlantic region of the U.S., with special emphasis on the regional transport of ground-level ozone and other related pollutants. It was created by Congress in 1990 and consists of the jurisdictions within Connecticut, Delaware, D.C., Maine, Maryland, Massachusetts, New Hampshire, New Jersey, New York, Pennsylvania, Rhode Island, Vermont, and Virginia. OTC has recently developed an Emission Reduction Workbook to provide a method of assessing the emissions impacts of a range of energy policies affecting the electric industry. The geographic focus of the workbook is the three northeastern electricity control areas: Pennsylvania/New Jersey/Maryland (PJM), the New York Independent System Operator (NY ISO), and Independent System Operator-New England (ISO NE).

The three energy programs evaluated by the workbook are programs that: (1) displace generation (e.g., DG-CHP systems), (2) alter the average emission rate of the electricity used in a state or region (e.g., emissions performance standard), and (3) reduce emission rates of specific generating units (e.g., multi-pollutant regulations applied to existing generating units). To evaluate these programs, the workbook contains default displaced emission rates for the three northeastern control areas. The default displaced emission rates are divided into three time periods: near-term (2002-2005), medium-term (2006-2010), and long-term (2011-2020). This verification uses the short-term default emission rates for the NY ISO control area have been used to represent the ER_{Grid} variable shown in Equation 8.

The near-term rates for the NY ISO are summarized in Table B-1. These rates were compiled using the PROSYM electricity dispatch model and are reported to be representative of actual operations because the identity of generating units that constitute each regional power system are well known.

PROSYM is a chronological, multi-area electricity market simulation model that is often used to forecast electricity market prices, analyze market power, quantify production cost and fuel requirements, and estimate air emissions. It simulates system operation on an hourly basis by dispatching generating units each hour to meet load. The simulation is based on unit-specific information on the generating units in multiple interconnection areas (unit type and size, fuel type, heat rate curve, emission and outage rates, and operating limitations) and on detailed data on power flows and transmission constraints within and between ISOs. Because the simulation is done in chronological order, actual constraints on system operation (such as unit ramp times and minimum up and down times) are taken into account. The resulting emission rates in one control region take into account emission changes in neighboring regions. PROSYM has been used by many organizations, including the EPA and Department of Justice, to pursue New Source Review violations. It has also been used by DOE, numerous utility companies, Federal Energy Regulatory Commission (FERC), and the Powering the South organization to simulate the electric power system in the southern U.S.

**Table B-1. Displaced Emission Rates For the NY ISO
(2002)**

	NO _x (lb/kWh _e)	CO ₂ (lb/kWh _e)
Ozone season weekday ^a	0.0021	1.37
Ozone season night/weekend ^b	0.0028	1.67
Non-ozone season weekday ^c	0.0021	1.46
Non-ozone season night/weekend ^d	0.0028	1.61
^a Average of all hourly marginal emission rates during weekdays, May through September, 7:00 a.m. through 10:59 p.m. ^b Average of all hourly marginal emission rates during all nights, May through September, 11:00 p.m. through 6:59 a.m., and all weekend days during this period ^c Average of all hourly marginal emission rates during weekdays, October through April, 7:00 a.m. through 10:59 p.m. ^d Average of all hourly marginal emission rates during all nights, October through April, 11:00 p.m. through 6:59 a.m., and all weekend days during this period		

OTC generated the displaced emission rates for the Northeast control areas by first performing a “base case” model run, simulating plant dispatch across all three control areas for the year. OTC then performed three “decrement” model runs. In one decrement run, all hourly loads in PJM were reduced by 1 percent; loads in ISO NE, and NY ISO were not reduced. In another decrement run, loads in ISO NE were reduced by 1 percent, and in the third, NY ISO loads were reduced. To calculate marginal emission rates for different periods, OTC calculated the total difference in kWhs generated between the base case and decrement case and the total difference in emissions and then divided the emissions by kWhs to derive the marginal emission rate for the time period. It should be noted that marginal rates shown in Table 1-5 takes into account changes in generation in all areas resulting from the load reductions in the target DG-CHP use area. This includes analysis of emissions changes across six interconnected control areas: PJM, NY ISO, ISO NE, Canada’s Maritime Provinces, Ontario, and Quebec.