

US EPA ARCHIVE DOCUMENT

Environmental Technology Verification Report

Removal of Arsenic in Drinking Water

Hydranautics ESPA2-4040 Reverse Osmosis Membrane Element Module

Prepared by



NSF International

 Under a Cooperative Agreement with
U.S. Environmental Protection Agency

ET ✓ ET ✓ ET ✓

THE ENVIRONMENTAL TECHNOLOGY VERIFICATION PROGRAM



U.S. Environmental Protection Agency



NSF International

ETV Joint Verification Statement

TECHNOLOGY TYPE:	REVERSE OSMOSIS MEMBRANE FILTRATION USED IN PACKAGED DRINKING WATER TREATMENT SYSTEMS		
APPLICATION:	REMOVAL OF ARSENIC IN DRINKING WATER AT PARK CITY, UTAH		
TECHNOLOGY NAME:	HYDRANAUTICS ESPA2-4040 REVERSE OSMOSIS MEMBRANE ELEMENT MODULE		
COMPANY:	HYDRANAUTICS		
ADDRESS:	401 JONES ROAD	PHONE: (760) 901-2500	
	OCEANSIDE, CALIFORNIA 92054	FAX: (760) 901-2578	
WEB SITE:	http://www.membranes.com		
EMAIL:	iwilf@hydranautics.com		

The U.S. Environmental Protection Agency (EPA) has created the Environmental Technology Verification (ETV) Program to facilitate the deployment of innovative or improved environmental technologies through performance verification and dissemination of information. The goal of the ETV program is to further environmental protection by substantially accelerating the acceptance and use of improved and more cost-effective technologies. ETV seeks to achieve this goal by providing high quality, peer reviewed data on technology performance to those involved in the design, distribution, permitting, purchase, and use of environmental technologies.

ETV works in partnership with recognized standards and testing organizations; stakeholders groups which consist of buyers, vendor organizations, and permittees; and with the full participation of individual technology developers. The program evaluates the performance of innovative technologies by developing test plans that are responsive to the needs of stakeholders, conducting field or laboratory tests (as appropriate), collecting and analyzing data, and preparing peer reviewed reports. All evaluations are conducted in accordance with rigorous quality assurance protocols to ensure that data of known and adequate quality are generated and that the results are defensible.

NSF International (NSF) in cooperation with the EPA operates the Drinking Water Treatment Systems (DWTS) pilot, one of 12 technology areas under ETV. The DWTS pilot recently evaluated the performance of a reverse osmosis membrane system used in package drinking water treatment system applications. This verification statement provides a summary of the test results for the Hydranautics ESPA2-4040 Reverse Osmosis Membrane Element Module System. Cartwright, Olsen and Associates, LLC, an NSF-qualified field testing organization (FTO), performed the verification testing.

ABSTRACT

Verification testing of the Hydranautics ESPA2-4040 Reverse Osmosis Membrane Element Module was conducted over a 34-day period from March 15, 2000 through April 17, 2000. The test was conducted at Park City Spiro Tunnel Water Filtration Plant in Park City, Utah. The source water was the Spiro Tunnel Bulkhead water, which is considered a groundwater source. Based on manufacturer's recommendations, the unit was set to operate at 150 psi inlet pressure, a water recovery of 15%, and a specific flux of 0.15-0.16 gfd/psi (25°C). The total arsenic (As) concentration in the feedwater averaged 65 ug/L during the test period. The Hydranautics unit reduced total As to an average of 0.5 ug/L in the treated water. The Hydranautics unit reduced the dissolved As in the feedwater from an average of 42 ug/L to less than 0.8 ug/L in the permeate (treated water). The dominant As species in the feedwater is As (V). The feedwater average concentration of As (V) was 35 ug/L and was reduced to an average level of 0.5 ug/L in the treated water. As (III) was also rejected by the membrane, reducing the average feedwater level from 7 ug/l to 0.5 ug/L in the permeate. The system operated continuously over the verification test period and achieved an average total As removal of 99%. Dissolved As, which represented 65% of the As in the feedwater, showed an average removal of 98%. The system was cleaned at the end of the test period to demonstrate the cleaning procedures. There was no significant fouling of the membrane during the verification test period operating at 15% recovery.

TECHNOLOGY DESCRIPTION

Reverse Osmosis (RO) processes are generally used to remove dissolved salts and ionic solids, such as As, sodium, chloride, and other dissolved materials from drinking water. RO membranes will also remove particulate contaminants, but high particulate loads can lead to membrane fouling. Certain polymers can reject more than 99% of all ionic solids and have a molecular weight cut-off in the range of 50 to 100 daltons. The Hydranautics ESPA2-4040 membrane is a hollow membrane made from a composite polyamide material with a molecular weight cut-off of 300-500 daltons. RO membranes are designed to reject dissolved salts and operate at pressures that are typically an order of magnitude higher than membrane filtration processes designed to remove only particulate matter. RO operating pressure requirements are a function of the concentration of the contaminants in the feedwater. Larger contaminant levels in the water will require higher pressure to effect the separation. The Hydranautics membrane is rated for a maximum pressure of 600 psi and normal design pressure of 150 psi.

The Hydranautics ESPA2-4040 Elements are enclosed in a Codeline U4B membrane pressure vessel, which is part of the element module. Each element is 4 x 40 inches and has an active membrane surface of 85 ft². The element is designed to operate at a minimum flow rate of 3 gallons per minute (gpm) and a maximum flow rate of 16 gpm. The elements are designed for a maximum recovery of 20% and a design specific flux of 0.24 gfd/psi at 25°C.

The verification testing was performed using a Hydranautics ROSY-200 pilot test unit. The test unit is a self-contained system, housing a Goulds G & L Model 25VBK 11 high pressure pump, two pressure vessels, each containing a reverse osmosis membrane element, and all piping, wiring, and flow/pressure controls for operation. A pre-filter, using a 5µ cartridge was placed in the feedwater line prior the high pressure pump. This pre-filter removed larger particulate matter that could foul the membranes.

The ROSY-200 pilot test unit is equipped with three way valves for use in cleaning and backwashing the membrane. A 50-gallon cleaning tank was set up to provide a cleaning solution supply that was pumped to the unit through a 5µ filter. The unit was designed so that permeate and concentrate streams were redirected back to the cleaning tank for recirculation during the cleaning process.

VERIFICATION TESTING DESCRIPTION

Test Site

The verification testing site was the Park City Spiro Tunnel Water Filtration Plant in Park City, Utah. The source water was the Spiro Tunnel Bulkhead water, which is considered a groundwater source under the State of Utah source water protection program. Water is developed from water bearing fissures in an abandoned silver mine tunnel. A five-foot bulkhead built approximately two miles into the tunnel holds back the water and creates a reservoir. Water is piped from this reservoir to the treatment plant through a 12-inch diameter pipe. The water is considered stable with respect to quality and quantity, and is known to contain As.

Methods and Procedures

Conductivity, pH and turbidity measurements were conducted on-site, using equipment set up in the filtration plant laboratory and in accordance with *Standard Methods for the Examination of Water and Wastewater*, 18th edition, (APHA, et. al., 1992). Conductivity was monitored twice per day, while pH and turbidity were monitored once per day. Turbidity information was also collected daily from the filtration plant continuous in-line monitor. Temperature was recorded daily from the calibrated in-line thermometer located on the test unit. The Silt Density Index (SDI), a measure of the quantity of suspended solids in the feedwater, was determined on-site at six occasions using ASTM D 4189-95. Samples for total dissolved solids (TDS) were collected twice per week and sent to the State of Utah Division of Drinking Water Laboratory. Other analyses performed at the State of Utah laboratory included fluoride, iron (Fe), manganese, and sulfate on a weekly basis, and alkalinity, suspended solids, silica, total organic carbon (TOC) and Langlier Saturation Index (LSI) on a monthly basis. The off-site laboratory followed test procedures as described in *Methods for Chemical Analysis of Water and Wastes* (EPA, 1979), except for TOC, which was analyzed in accordance with *Standard Methods*. Magnesium and chloride were also measured during the verification test period.

Samples of the feedwater, concentrate, and permeate were collected on a daily basis and sent to the State of Utah Laboratory for As analysis. Special procedures were used to prepare the samples so that As speciation could be determined. Field procedures included filtering an aliquot of sample for the determination of dissolved As, and passing an aliquot of filtered sample through an ion exchange resin so that the concentration of As (III) and As (V) could be determined. All samples were preserved with acid mixtures described in the As speciation procedure. The daily results for total As, dissolved As, As (III) and As (V) were obtained using ICP/MS analysis in accordance with USEPA Method 200.8 as described in *Methods for the Determination of Metals in Environmental Samples Supplement I* (EPA, 1994). Antimony (Sb) analyses were performed on a daily basis by the off-site laboratory using Method 200.8.

VERIFICATION OF PERFORMANCE

System Operation

The Rosy-200 pilot test unit was set up in accordance with the manufacturer's recommendations and operated for a one-week period to establish optimum operating conditions. The major operating parameters monitored during the initial operating period were specific flux, net driving pressure and percent water recovery. Initial operating conditions were set to achieve a water recovery of 15% with an inlet pressure of 150 psi and specific flux of 0.16 gfd/psi (at 25°C). The system operating conditions were very stable during the initial startup period with the permeate flow rate remaining steady at 0.79 to 0.81 gpm. No significant changes were required in the operating conditions of the system during the startup period.

The unit was operated at an inlet operating pressure of 150 psi (range 144-151 psi). Inlet water temperature was 49°F (9.44°C) based on twice-daily measurements. Flow rates for the concentrate and permeate streams were monitored twice per day. The permeate flow averaged 0.77 gpm with a range of 0.74 to 0.81 gpm. Water recovery data calculated twice per day ranged from 13.5% to 15%. The twice-daily conductivity measurements were correlated with the TDS data to obtain twice daily TDS estimates for calculating specific flux. The specific flux remained stable throughout the entire test period. The average specific flux was 0.15 gfd/psi (at 25°C) with a range of 0.15 to 0.16 gfd/psi (at 25°C).

The system was operated with a 5µ cartridge filter in the feedwater line to the system. The filter was initially changed on an every two-day basis for the first 18 days of the test period. Following a high turbidity measurement by the filtration plant in-line monitor, the cartridge filter was changed daily for the remaining 16 days of the verification test.

The RO membrane elements were operated for the entire 34-day test period without shutting down for cleaning. Membrane cleaning was performed at the end of the test period to test the cleaning process. The unit was cleaned using 50 gallons of 2% (wt/wt) citric acid solution. The cleaning solution was circulated through the membrane module for one hour followed by a 1¾hour soaking time. The unit was then rinsed with feedwater for approximately ½hour and placed back on-line. Operating data collected after the cleaning showed that the unit returned to typical operating conditions prior to the cleaning process with permeate flow of 0.77 gpm and a specific flux of 0.15 gfd/psi (at 25°C).

Water Quality Results

All of the feedwater samples, with the exception of the samples for turbidity, were collected immediately before the membrane and after the raw water had passed through the 5µ cartridge filter. The feedwater from the Spiro Tunnel Bulkhead had the following average water quality during the verification test period: TDS 547 mg/l, pH 7.33, Fe 0.154 mg/l, sulfate 278 mg/l, alkalinity 144 mg/l, and temperature 49°F (9.44°C). The turbidity, as measured before the 5µ cartridge filter, ranged from 0.78 to 3.65 NTU with one spike to 11.79 NTU on the in-line meter. The feedwater total As levels averaged 65 ug/l. Results of the dissolved As analysis showed that 65% of the As present in the feedwater was in the dissolved form. Arsenic speciation for valence states (III) and (V) showed that As (V) represented 83% of the dissolved As in the source water. Sb levels in the feedwater averaged 8.6 ug/l.

The Hydranautics ESPA2-4040 Reverse Osmosis Membrane Element Module averaged 99% removal of the total As in the feedwater over the verification test period. The calculated removal is most likely a conservative number as the As concentration in the permeate was reported as less than 0.5 ug/l (minimum laboratory reporting limit) for all but two days of the test period. As shown in the table below, the unit was able to produce a consistent high quality permeate with total As levels below 0.5 ug/l over the range of feedwater concentrations (49.4-114 ug/l).

Total Arsenic Data Summary				
	Feed (µg/L)	Concentrate (µg/L)	Permeate (µg/L)	% Rejection
Average	65	62	0.5	99
Minimum	49.3	44.2	<0.5	99.0
Maximum	114	99	0.52	99.6
Standard Deviation	12	11	0.0	.0035
Confidence Interval	(61, 69)	(59, 66)	(0.5, 0.5)	(99, 99)

Dissolved As results showed that the system achieved an average rejection of 98% for dissolved As with a range of 97.1% to 99%. The calculated rejection percentages were influenced by a possible analytical problem at the low levels being monitored in the permeate. This may have been caused by some type of

contamination or interference due to the procedures used to preserve and handle the samples for dissolved As and As speciation.

Dissolved Arsenic Data Summary

	Feed (µg/L)	Concentrate (µg/L)	Permeate (µg/L)	% Rejection
Average	42	47	0.8	98
Minimum	32.2	21.9	<0.5	97.1
Maximum	52	61	1	99
Standard Deviation	5.6	8.3	0.1	0.41
Confidence Interval	(40, 44)	(44, 50)	(0.8, 0.9)	(98, 98)

The As speciation results showed that As (V) was the predominate species present in the feedwater with 83% of the dissolved As determined to be As (V). The Hydranautics unit averaged 99% removal of the As (V) and generated a permeate that was less than 0.5 ug/l on most operating days. The system also removed As (III) to less than 0.5 ug/l on all but two days of the test period. The calculated As (III) removal averaged 84%, but this calculation was strongly influenced by the low feedwater levels (average of 7 ug/l) and the laboratory detection limit of 0.5 ug/l.

Arsenic (V) Data Summary

	Feed (µg/L)	Concentrate (µg/L)	Permeate (µg/L)	% Rejection
Average	35	40	0.5	99
Minimum	20.4	19.2	<0.5	97.6
Maximum	50.2	55.8	0.5	99.0
Standard Deviation	7.3	8.9	0.0	0.35
Confidence Interval	(32, 38)	(36, 43)	(0.5, 0.5)	(98, 99)

Total Sb results showed that the permeate concentration was less than 3.0 ug/l in all samples analyzed. The unit achieved the highest possible rejection percentage (67%) that could be calculated based on a maximum feed concentration of 9.2 ug/l and a laboratory MDL of 3.0 ug/l.

Operation and Maintenance Results

The system ran continuously throughout the duration of the verification test (34 days). The feed pump was shut down for five minutes each day to change the 5µ cartridge filter. Once the flows, pressures, and water recovery conditions were established during the Initial Operations period, no adjustments were made throughout the duration of the test. A manual cleaning was performed at the end of the test.

There was no evidence during the test period of any operationally significant chemical fouling of the membrane element. The cleaning at the end of the test period was performed only to evaluate the cleaning procedures and any effects on the membrane. Mass balances using the Fe and As data did indicate the possible buildup of some materials within the membrane. However, there was no change in basic operating conditions during the 34-day test, and any buildup that might have occurred did not seem to affect the membrane operation or performance.

The Operation and Maintenance Manual provided by Hydranautics was available for review and to assist with on-site operations. The Manual gave a basic overview of RO systems operation and gave helpful information on how to troubleshoot the system.

The consumables used by the system were the prefilter cartridges and citric acid cleaning chemical. A prefilter cartridge (5µ, 20 inches long) was replaced daily. The quantity of citric acid cleaning chemical

was 50 gallons of 2% (wt/wt) per module. The total power consumed throughout testing was 90.740 Kilowatt/hours.

<i>Original Signed by</i> <u>E. Timothy Oppelt</u>	<u>04/18/01</u>	<i>Original Signed by</i> <u>Gordon Bellen</u>	<u>04/27/01</u>
E. Timothy Oppelt	Date	Gordon Bellen	Date
Director		Vice President	
National Risk Management Research Laboratory		Federal Programs	
Office of Research and Development		NSF International	
United States Environmental Protection Agency			

NOTICE: Verifications are based on an evaluation of technology performance under specific, predetermined criteria and the appropriate quality assurance procedures. EPA and NSF make no expressed or implied warranties as to the performance of the technology and do not certify that a technology will always operate as verified. The end user is solely responsible for complying with any and all applicable federal, state, and local requirements. Mention of corporate names, trade names, or commercial products does not constitute endorsement or recommendation for use of specific products. This report is not a NSF Certification of the specific product mentioned herein.

Availability of Supporting Documents

Copies of the *ETV Protocol for Equipment Verification Testing for Removal of Arsenic (Chapter One General Requirements)* dated March 30, 2000, *ETV Protocol for Equipment Verification Testing for Removal of Inorganic Chemical Constituents (Test Plan: Reverse Osmosis for the Removal of Inorganic Contaminants)* dated February 25, 2000, the Verification Statement, and the Verification Report (NSF Report #01/20/EPADW395) are available from the following sources:

(NOTE: Appendices are not included in the Verification Report. Appendices are available from NSF upon request.)

1. Drinking Water Systems ETV Pilot Manager (order hard copy)
NSF International
P.O. Box 130140
Ann Arbor, Michigan 48113-0140
2. NSF web site: <http://www.nsf.org/etv> (electronic copy)
3. EPA web site: <http://www.epa.gov/etv> (electronic copy)

March 2001

Environmental Technology Verification Report

Removal of Arsenic from Drinking Water

Hydranautics ESPA2-4040 Reverse Osmosis Membrane Element Module

Prepared for

NSF International
Ann Arbor, MI 48105

Prepared by

Cartwright, Osen and Associates, LLC
19406 East Bethel Blvd.
Cedar, Minnesota 55011
(612) 434-1300

Under a cooperative agreement with the U.S. Environmental Protection Agency

Jeffrey Q. Adams, Project Officer
National Risk Management Research Laboratory
U.S. Environmental Protection Agency
Cincinnati, Ohio 45268

Notice

The U.S. Environmental Protection Agency (EPA) through its Office of Research and Development has financially supported and collaborated with NSF International (NSF) under Cooperative Agreement No. CR 824815. This verification effort was supported by the Drinking Water Treatment Systems Pilot operating under the Environmental Technology Verification (ETV) Program. This document has been peer reviewed and reviewed by NSF and EPA and recommended for public release.

Foreword

The following is the final report on an Environmental Technology Verification (ETV) test performed for NSF International (NSF) and the United States Environmental Protection Agency (EPA) by Cartwright, Olsen & Associates, LLC (COA) in cooperation with Hydranautics. The test was conducted during March and April of 2000, at the Spiro Tunnel Water Treatment Plant, Park City, Utah.

Throughout its history, the EPA has evaluated the effectiveness of innovative technologies to protect human health and the environment. The ETV Program has been instituted to verify the performance of innovative technical solutions to environmental pollution or human health threats. ETV was created to substantially accelerate the entrance of new environmental technologies into the domestic and international marketplace. Verifiable, high quality data on the performance of new technologies is made available to regulators, developers, consulting engineers, and those in the public health and environmental protection industries. This encourages more rapid availability of approaches to better protect the environment.

The EPA has partnered with NSF, an independent, not-for-profit testing and certification organization dedicated to public health, safety and protection of the environment, to verify performance of small package drinking water systems that serve small communities under the Drinking Water Treatment Systems (DWTS) ETV Pilot. A goal of verification testing is to enhance and facilitate the acceptance of small package drinking water treatment equipment by state drinking water regulatory officials and consulting engineers while reducing the need for testing of equipment at each location where the equipment's use is contemplated. NSF will meet this goal by working with manufacturers and NSF-qualified Field Testing Organizations (FTO) to conduct verification testing under the approved protocols.

NSF is conducting the DWTS ETV Pilot with participation of manufacturers, under the sponsorship of the EPA Office of Research and Development, National Risk Management Research Laboratory, Water Supply and Water Resources Division, Cincinnati, Ohio. It is important to note that verification of the equipment does not mean that the equipment is "certified" by NSF or "accepted" by EPA. Rather, it recognizes that the performance of the equipment has been determined and verified by these organizations for those conditions tested by the FTO.

Table of Contents

<u>Section</u>	<u>Page</u>
Verification Statement	VS-i
Title Page.....	i
Notice	ii
Foreword	iii
Table of Contents.....	iv
Abbreviations and Acronyms.....	ix
Operational Formulae.....	xi
Acknowledgments.....	xv
Chapter 1 - Introduction.....	1
1.1 ETV Purpose and Program Operation.....	1
1.2 Testing Participants and Responsibilities.....	1
1.2.1 NSF International.....	2
1.2.2 Field Testing Organization	2
1.2.3 Manufacturer	3
1.2.4 Analytical Laboratory.....	3
1.2.5 U.S. Environmental Protection Agency	4
1.2.6 Park City Municipal Corporation, Spiro Tunnel Water Filtration Plant	4
1.3 Verification Testing Site.....	4
1.3.1 Water Source	5
1.3.2 Pilot Effluent Discharge.....	7
1.4 Arsenic Chemistry.....	7
1.4.1 Health Concerns	8
1.4.2 Regulatory	9
Chapter 2 - Equipment Description and Operating Processes	10
2.1 Equipment Description	10
2.2 Operating Process.....	17
2.3 Equipment Capabilities	19
Chapter 3 - Methods and Procedures	22
3.1 Experimental Design.....	22
3.1.1 Objectives	22
3.1.2 Equipment Characteristics	22
3.1.3 Water Quality Data Collection and Analysis	23
3.2 Recording Data.....	24
3.3 Communications, Logistics And Data Handling Protocol	24
3.3.1 Objectives	25
3.3.2 Procedures	25
3.3.2.1 Log Books	25
3.3.2.2 Photographs	25

Table of Contents, continued

<u>Section</u>	<u>Page</u>
3.3.2.3 Chain of Custody.....	25
3.3.2.4 Spreadsheets.....	25
3.4 Recording Statistical Uncertainty.....	26
3.5 Verification Testing Schedule.....	26
3.6 Field Operations Procedures.....	26
3.6.1 Equipment Operations.....	27
3.6.1.1 Operations Manual.....	27
3.6.1.2 Analytical Equipment.....	27
3.6.2 Initial Operations.....	27
3.6.2.1 Flux.....	28
3.6.2.2 Net Driving Pressure.....	29
3.6.2.3 Percent Water Recovery.....	29
3.7 Verification Task Procedures.....	29
3.7.1 Task 1: Membrane Operation.....	29
3.7.1.1 Water Recovery.....	29
3.7.1.2 Applied Pressure.....	30
3.7.1.3 Prefilter Replacement Frequency.....	30
3.7.2 Task 2: Cleaning Efficiency.....	30
3.7.3 Task 3: Finished Water Quality.....	33
3.7.3.1 Sample Collection and Analysis Procedure.....	33
3.7.4 Task 4: Data Handling Protocol.....	33
3.8 QA/QC Procedures.....	34
3.8.1 Instruments with Daily QA/QC Verification Procedures.....	34
3.8.1.1 pH Meter.....	34
3.8.1.2 Conductivity Monitor.....	34
3.8.2 In-Line Thermometer.....	34
3.8.3 In-Line Pressure Gauges.....	35
3.8.4 In-Line Flow Meters.....	35
3.8.5 Turbidity Meters.....	35
3.8.6 Tubing and Fittings.....	35
3.8.7 Off-Site Analysis of Chemical Samples.....	35
3.8.7.1 Organic Parameters (Total Organic Carbon).....	35
3.8.7.2 Inorganic Samples.....	36
3.8.8 SDI Measurements.....	36
Chapter 4 - Results and Discussion.....	37
4.1 Introduction.....	37
4.2 Initial Operations Results.....	37
4.2.1 Startup Period.....	37
4.2.2 Water Recovery.....	37
4.2.3 Operating Pressure.....	37
4.3 Verification Testing Results and Discussion.....	38

Table of Contents, continued

<u>Section</u>	<u>Page</u>
4.3.1 Task 1: Membrane Operation.....	38
4.3.2 Task 2: Cleaning Efficiency.....	46
4.3.3 Task 3: Finished Water Quality.....	48
4.4 Results of Equipment Characterization	73
4.4.1 Qualitative Factors	73
4.4.1.1 Susceptability to Change in Environmental Conditions	73
4.4.1.2 Operational Reliability.....	74
4.4.1.3 Equipment Safety.....	74
4.4.2 Quantitative Factors	75
4.4.2.1 Electical Power.....	75
4.4.2.2 Consumables.....	75
4.4.2.3 Waste Disposal	75
4.4.2.4 Length of Operating Cycle	76
4.5 QA/QC Results	76
4.5.1 In-Line Thermometer	76
4.5.2 Conductivity Monitor	76
4.5.3 Pressure Gauges	76
4.5.4 Flow Monitoring	77
4.5.5 pH Meter.....	77
4.5.6 Turbidity Instrumentation.....	77
4.5.7 Tubing and Fittings	77
4.5.8 Off-Site Analysis of Chemical Samples	78
4.5.8.1 Organic Parameters (Total Organic Carbon)	78
4.5.8.2 Inorganic Samples	78
4.5.9 SDI Measurements	78
4.5.10 Arsenic Speciation and Analysis	78
Chapter 5 – References.....	79

<u>Table</u>	<u>Page</u>
Table 1-1: Historical Spiro Tunnel Bulkhead Untreated Water Quality.....	7
Table 1-2: Selected Inorganic Arsenic Compounds.....	8
Table 2-1: Hydranautics Membrane Element Module Characteristics	17
Table 3-1: Analytical Data Collection Schedule	23
Table 3-2: Operational Data Collection Data.....	24
Table 4-1: Total Dissolved Solids Summary	39
Table 4-2: Total Dissolved Solids, Conductivity and TDS/ Conductivity Ratio vs. Time	40
Table 4-3: TDS to Conductivity Ratio Summary.....	40
Table 4-4: Specific Flux Data vs. Time.....	42
Table 4-5: Specific Flux Data Summary (gfd/psi)	42
Table 4-6: Feedwater SDI Measurements	44
Table 4-7: Turbidity Readings (NTU) vs. Time	46
Table 4-8 Membrane Element System Cleaning Data	47

Table of Contents, continued

<u>Table</u>	<u>Page</u>
Table 4-9: Operating Data after Cleaning	48
Table 4-10: Module Performance after Cleaning	48
Table 4-11: Total Arsenic Readings	52
Table 4-12: Total Arsenic Data Summary	53
Table 4-13: Dissolved Arsenic Data	55
Table 4-14: Dissolved Arsenic Data Summary	56
Table 4-15: Arsenic (III) Data	58
Table 4-16: Arsenic (III) Data Summary	58
Table 4-17: Arsenic (V) Data	60
Table 4-18: Arsenic (V) Data Summary	61
Table 4-19: Percentage of Various Arsenic Species Based on Summary Average Values	62
Table 4-20: Summary of Total and Dissolved Arsenic Mass Balances	63
Table 4-21: Antimony Concentrations in Feed, Concentration and Permeate Streams	66
Table 4-22: pH Data vs. Time	68
Table 4-23: pH Data Summary	69
Table 4-24: Iron Concentrations	70
Table 4-25: Estimated Concentration of Iron Retained in Module	70
Table 4-26: Weekly Analytical Parameters	73

<u>Figure</u>	<u>Page</u>
Figure 1-1: Schematic of Spiro Tunnel Water Filtration Plant	6
Figure 2-1: ROSY – 200 Testing Unit	11
Figure 2-2: Conventional vs. Crossflow Filtration	18
Figure 2-3: Reverse Osmosis	18
Figure 2-4: Process Flow Diagram	21
Figure 4-1: Variation of Average Specific Flux Data vs. Time	43
Figure 4-2: Feedwater SDI Measurements vs. Time	44
Figure 4-3: Total Concentration Data vs. Time	53
Figure 4-4: Dissolved Arsenic Concentration Data vs. Time	56
Figure 4-5: Arsenic (III) Concentration Data vs. Time	59
Figure 4-6: Arsenic (V) Concentration Data vs. Time	61
Figure 4-7: Antimony Concentration vs. Time	67
Figure 4-8: pH Concentrations over Testing Period	69

Photographs

Photograph 1: Membrane Element Module Test Unit showing prefilter housings and high pressure pump	12
Photograph 2: Membrane Element Module Test Unit showing prefilter housings and high pressure pump	13
Photograph 3: Membrane Element Module Test Unit showing feed end of module	14
Photograph 4: Membrane Element Module Test Unit showing permeate and concentrate end of module	15
Photograph 5: CIP unit used for cleaning membrane element modules	32

Table of Contents, continued

Appendices

- A. Historical Water Quality Data for Park City, Utah
- B. Manufacturer's Specification Sheets and O&M Manual
- C. Arsenic Speciation Procedure
- D. Laboratory Analytical Results
- E. State of Utah Laboratory QA/QC Manual
- F. Certificates of Calibration and NIST Traceability
- G. On-Site Logbook
- H. Filter Disks from Speciation Activity
- I. QA/QC Procedures, Data and Discussion

Abbreviations and Acronyms

ASTM	American Society for Testing and Materials
°C	Celsius degrees
cfu	Colony forming unit(s)
CIP	Clean in place
COA	Cartwright, Olsen & Associates, LLC
CV	Curriculum Vitae
EPA	U.S. Environmental Protection Agency
ESWTR	Enhanced Surface Water Treatment Rule
ETV	Environmental Technology Verification
FOD	Field Operations Document
ft ²	Square foot (feet)
FPT	Female Pipe Thread
FTO	Field Testing Organization
gfd	Gallon(s) per day per square foot of membrane area
gpm	Gallon(s) per minute
HPC	Heterotrophic plate count bacteria
ICR	Information Collection Rule
J_t	Permeate flux
J_{tm}	Transmembrane flux
J_{em}	Specific flux
Kg	Kilogram(s)
L	Liters
LMD	Liters per day per square meter of membrane area
μ	Micron(s)
MDL	Minimum Detection Level
m ²	Square meter(s)
m ³ /d	Cubic meter(s) per day
MCL	Maximum Contaminant Level
MCLG	Maximum Contaminant Level Goal
μ g/L	Microgram(s) per liter (ppb)
μ S	Microsiemens
mgd	Million gallon(s) per day
mg/L	Milligram(s) per liter
min	Minute(s)
mL	Milliliter(s)
Modular System	A packaged functional assembly of components for use in a drinking water treatment system or packaged plant that provides a limited form of treatment of the feedwater(s) and which is discharged to another packaged plant or the final step of treatment to the distribution system.
MPN	Most probable number
NSF	NSF International, formerly known as National Sanitation Foundation
NIST	National Institute of Standards and Technology
NTU	Nephelometric turbidity unit(s)

P_i	Pressure at inlet of membrane module
P_o	Pressure at outlet of membrane module
P_p	Permeate pressure
P_{tm}	Transmembrane pressure
PLC	Programmable Logic Controller
ppb	Parts per billion ($\mu\text{g/L}$)
psi	Pound(s) per square inch
PVC	Polyvinyl chloride
PVR	Performance Verification Report
Q_f	Feed flow
Q_p	Permeate flow
QA	Quality assurance
QC	Quality control
RO	Reverse osmosis
S	Membrane surface area
scfm	Standard cubic feet per minute
sec	Second(s)
SWTR	Surface Water Treatment Rule
T	Temperature
TC	Total coliform bacteria
TDS	Total dissolved solids
TOC	Total organic carbon
TSS	Total suspended solids
USP	United States Pharmacopoeia – pharmaceutical grade chemicals
UV-254	Ultraviolet light absorbance at 254 nanometers
WEF	Water Environment Federation
WHO	World Health Organization

Operational Formulae

Permeate: Water produced by the RO membrane process.

Feedwater: Water introduced to the membrane element.

Permeate Flux: The average permeate flux is the flow of permeate divided by the surface area of the membrane. Permeate flux is calculated according the following formula:

$$J_t = \frac{Q_p}{S}$$

where:

- J_t = permeate flux at time t (gpd, L/(h·m²))
- Q_p = permeate flow (gpd, L/h)
- S = membrane surface area (ft², m²)

It should be noted that only gfd and LMD are considered acceptable units for this testing plan.

Net Driving Pressure: For this test, a temperature conversion chart provided by the manufacturer was used for all temperature correction. Net Driving Pressure is the total average pressure available to force water through the membrane into the permeate stream. Net driving pressure is calculated according to the following formula:

$$NDP = \left[\frac{(P_f + P_c)}{2} \right] - P_p - \Delta p$$

where:

- NDP = net driving pressure for solvent transport across the membrane (psi, bar)
- P_f = feedwater pressure to the feed side of the membrane (psi, bar)
- P_c = concentrate pressure on the concentrate side of the membrane (psi, bar)
- P_p = permeate pressure on the treated water side of the membrane (psi, bar)
- Δp = osmotic pressure (psi)

Osmotic Pressure Gradient: The term osmotic pressure gradient refers to the difference in osmotic pressure generated across the membrane barrier as a result of different concentrations of dissolved salts. The following equation provides an estimate of the osmotic pressure across the semi-permeable membrane through generic use of the difference in total dissolved solids (TDS) concentrations on either side of the membrane:

$$\Delta p = \left[\left[\frac{(TDS_f + TDS_c)}{2} \right] - TDS_p \right] \left[\frac{1 \text{ psi}}{100 \frac{\text{mg}}{\text{L}}} \right]$$

where:

- Δp = osmotic pressure (psi)
- TDS_f = feedwater total dissolved solids (TDS) concentration (mg/L)
- TDS_c = concentrate TDS concentration (mg/L)
- TDS_p = permeate TDS concentration (mg/L)

Note that the different proportions of monovalent and multivalent ions composing the TDS will influence the actual osmotic pressure, with lower unit pressures resulting from multivalent species. The osmotic pressure ratio of 1 psi per 100 mg/L is based upon TDS largely composed of sodium chloride or other monovalent ions. In contrast, for TDS composed of multivalent ions, the ratio is closer to 0.5 psi per 100 mg/L TDS.

In this test, since specific conductivity was measured twice a day and TDS measured (by evaporation) once a week, to be more accurate, conductivity was used in the daily osmotic pressure calculations, from which daily Net Driving Pressures and Specific Fluxes were calculated. The following equation is based on conductivity values:

$$\Delta p = \left[\left[\frac{(Cond_f + Cond_c)}{2} \right] - Cond_p \right] \left[\frac{1 \text{ psi}}{100 \frac{\text{mg}}{\text{L}}} \right] K$$

where:

- Δp = osmotic pressure (psi)
- $Cond_f$ = Feedwater conductivity (microsiemens/cm)
- $Cond_c$ = Concentrate conductivity (microsiemens/cm)
- $Cond_p$ = Permeate conductivity (microsiemens/cm)
- K = multiplier based on average TDS/conductivity ratios

A multiplier (K) was empirically developed to convert the daily conductivity readings to osmotic pressure readings. This multiplier is more completely described and defined in 4.3.1.

Specific Flux: The term specific flux is used to refer to permeate flux that has been normalized for the net driving pressure. The equation used for calculation of specific flux is given by the formula provided below. Specific flux is usually calculated with use of flux values that have been temperature-adjusted to 25 °C:

$$J_{tm} = \frac{J_t}{NDP}$$

where:

- J_{tm} = specific flux
- NDP = net driving pressure for solvent transport across the membrane (psi, bar)
- J_t = permeate flux at time t (gfd, LMD). Temperature-corrected flux values should be employed

Water Recovery: The recovery of feedwater as permeate water is given as the ratio of permeate flow to feedwater flow:

$$\% \text{ System Recovery} = 100 \left[\frac{Q_p}{Q_f} \right]$$

where:

- Q_f = feedwater flow to the membrane (gpm, L/h)
- Q_p = permeate flow (gpm, L/h)

Solute Rejection: Solute rejection is controlled by a number of operational variables that must be reported at the time of water sample collection. Bulk rejection of a targeted inorganic chemical contaminant may be calculated by the following equation:

$$\% \text{ Solute Rejection} = 100 \left[\frac{C_f - C_p}{C_f} \right]$$

where:

- C_f = feedwater concentration of specific constituent (mg/L)
- C_p = permeate concentration of specific constituent (mg/L)

Solvent and Solute Mass Balance: Calculation of solvent mass balance will be performed during Task 1 in order to verify the reliability of flow measurements through the membrane. Calculation of solute mass balance across the membrane system will be performed as part of Task 3 in order to estimate the concentration of limiting salts at the membrane surface.

$$Q_f = Q_p + Q_c$$

$$Q_f C_f = Q_p C_p + Q_c C_c$$

where:

- Q_f = feedwater flow to the membrane (gpm, L/h)
- Q_p = permeate flow (gpm, L/h)
- Q_c = concentrate flow (gpm, L/h)
- C_f = feedwater concentration of specific constituent (mg/L, μ g/L)
- C_p = permeate concentration of specific constituent (mg/L, μ g/L)
- C_c = concentrate concentration of specific constituent (mg/L, μ g/L)

Acknowledgments

The Field Testing Organization, Cartwright, Olsen & Associates (COA), was responsible for all elements in the testing sequence, including collection of samples, calibration and verification of instruments, data collection and analysis, data management, data interpretation and the preparation of this report.

Cartwright, Olsen & Associates, LLC
19406 East Bethel Blvd.
Cedar, Minnesota 55011
Phone: (952) 854-4911
Fax: (952) 854-6964
E-mail: cartwrightconsul@cs.com
Contact Person: Peter Cartwright, P.E.

The laboratory that conducted the analytical work of this study was:

State of Utah
Department of Health
Division of Laboratory Services
46 Medical Drive
Salt Lake City, Utah 84113-1105
Phone: (801) 536-4204
Fax: (801) 615-5311
Contact: Larry P. Scanlan, Environmental Scientist III

The Manufacturer of the Equipment was:

Hydranautics
401 Jones Road
Oceanside, CA 92054
Phone: (760) 901-2510
Fax: (760) 901-2578
E-mail: iwilf@hydranautics.com
Contact Person: Ilan Wilf, Marketing Manager

COA wishes to thank NSF International, especially Mr. Bruce Bartley, Project Manger, and Ms. Carol Becker and Ms. Kristie Wilhelm, Environmental Engineers, for providing guidance and program management.

NSF wishes to thank Mr. Dale Scherger, Environmental Consultant, Scherger and Associates, for providing technical guidance.

Mr. Ilan Wilf, Marketing Manager, Hydranautics, is to be commended for providing the treatment system and the excellent technical and product expertise.

COA is especially indebted to the following individuals at the Spiro Tunnel Water Filtration Plant: Mr. John A. Lind, Assistant Public Works Director, Mr. Richard W. Hilbert, Assistant Public Superintendent, Mr. Leo Williams for his invaluable assistance in monitoring and sample collection speciation, and Mr. Jay Glazier and Mr. Scott Clayburn for their assistance to Mr. Williams.

Mr. Larry Scanlan, Environmental Scientist, State of Utah, Department of Environmental Quality, Division of Drinking Water, deserves special recognition for obtaining and regenerating the anion resin used for arsenic speciation. Dr. Zenon Pawlak, Chief of the Radiochem and Metals Lab, Division of Laboratory Services, was invaluable in his coordination of all laboratory analyses and processing of the resulting data. Mr. Wayne Pierce, Director of the Bureau of Environmental Chemistry and Toxicology, Division of Laboratory Services, is thanked for his able supervision of all analytical activities.

Chapter 1 Introduction

1.1 ETV Purpose and Program Operation

The U.S. Environmental Protection Agency (EPA) has created the Environmental Technology Verification (ETV) Program to facilitate the deployment of innovative or improved environmental technologies through performance verification and dissemination of information. The goal of the ETV program is to further environmental protection by substantially accelerating the acceptance and use of improved and more cost-effective technologies. ETV seeks to achieve this goal by providing high quality, peer reviewed data on technology performance to those involved in the design, distribution, permitting, purchase, and use of environmental technologies.

ETV works in partnership with recognized standards and testing organizations; stakeholders groups which consist of buyers, vendor organizations, and permitting agencies; and with the full participation of individual technology developers. The program evaluates the performance of innovative technologies by developing test plans that are responsive to the needs of stakeholders, conducting field or laboratory (as appropriate) testing, collecting and analyzing data, and preparing peer reviewed reports. All evaluations are conducted in accordance with rigorous quality assurance protocols to ensure that data of known and adequate quality are generated and that the results are defensible.

NSF International (NSF) in cooperation with the EPA operates the Drinking Water Treatment Systems (DWTS) program, one of 12 technology areas under ETV. This DWTS program evaluated the performance of the Hydranautics ESPA2-4040 Reverse Osmosis Membrane Element Module, which is a membrane filtration system used in package drinking water treatment system applications. The verification test focused on determining the capability of the membrane to remove total and dissolved arsenic from drinking water. This document provides the verification test results for the Hydranautics ESPA2-4040 Reverse Osmosis Membrane Element Module.

1.2 Testing Participants and Responsibilities

The ETV testing of the Hydranautics ESPA2-4040 Reverse Osmosis Membrane Element Module was a cooperative effort between the following participants:

- NSF International
- Cartwright, Olsen & Associates, LLC
- Hydranautics
- State of Utah Division of Drinking Water Laboratory
- U.S. Environmental Protection Agency
- Park City Municipal Corporation, Spiro Tunnel Water Filtration Plant

The following is a brief description of each ETV participant and their roles and responsibilities.

1.2.1 NSF International

NSF is a not-for-profit testing and certification organization dedicated to public health safety and the protection of the environment. Founded in 1946 and located in Ann Arbor, Michigan, NSF has been instrumental in the development of consensus standards for the protection of public health and the environment. NSF also provides testing and certification services to ensure that products bearing the NSF Name, Logo and/or Mark meet those standards. The EPA partnered with NSF to verify the performance of package drinking water treatment systems through the EPA's ETV Program.

NSF provided technical and primary quality oversight of the verification testing. NSF arranged an inspection of the field analytical and data gathering and recording procedures on April 17 and 18, 2000. NSF also reviewed of the Field Operations Document (FOD) to assure its conformance with the pertinent ETV generic protocol and test plan. NSF also conducted a review of this report and coordinated the EPA and technical reviews of this report.

Contact Information:

NSF International
789 N. Dixboro Rd.
Ann Arbor, MI 48105
Phone: (734) 769-8010
Fax: (734) 769-0109
E-mail: bartley@nsf.org
Contact: Bruce Bartley, Project Manager

1.2.2 Field Testing Organization

Cartwright, Olsen & Associates, a Limited Liability Company, conducted the verification testing of Hydranautics ESPA2-4040 Reverse Osmosis Membrane Element Module. COA is an NSF-qualified Field Testing Organization (FTO) for the Package Drinking Water Treatment System ETV pilot project.

The FTO was responsible for conducting the verification testing which covered a total of 34 days. The FTO provided all needed logistical support, established a communications network, and scheduled and coordinated activities of all participants. The FTO determined that the testing location and feed water conditions were such that the verification testing could meet its stated objectives. The FTO prepared the FOD, oversaw the pilot testing, managed, evaluated, interpreted and reported on the data generated by the testing, as well as evaluated and reported on the performance of the technology.

COA and the Spiro Tunnel Water Filtration Plant staff conducted the on-site analyses and data recording during the testing. Peter Cartwright, P.E. of COA, provided oversight of the daily tests.

Contact Information:

Cartwright, Olsen & Associates, LLC
19406 East Bethel Blvd.
Cedar, MN 55011
Phone: (952) 854-4911:
Fax (952) 854-6964
E-mail: cartwrightconsul@cs.com
Contact Person: Peter Cartwright, P.E., Project Manager

1.2.3 Manufacturer

The ESPA2-4040 Reverse Osmosis Membrane Element Module is manufactured by Hydranautics, a manufacturer of membrane separation products to municipal and industrial water users. Hydranautics is located in Oceanside, CA.

Hydranautics was responsible for supplying a field-ready RO membrane element module equipped with all necessary components as defined in 2.1 Equipment Description. Hydranautics also supplied the ROSY-200 pilot test unit for this verification testing. Hydranautics was responsible for providing logistical and technical support as needed as well as providing technical assistance to COA during operation and monitoring of the equipment undergoing field verification testing.

Contact Information:

Hydranautics
401 Jones Road
Oceanside, CA 92054
Phone: (760) 901-2510
Fax: (760) 901-2578
E-mail: iwilf@hydranautics.com
Contact: Ilan Wilf, Marketing manager

1.2.4 Analytical Laboratory

All chemical analyses were performed by the State of Utah Division of Drinking Water Laboratory. These analyses were made under the direct supervision of Larry P. Scanlan, Environmental Scientist III.

Contact Information:

State of Utah Division of Drinking Water Laboratory
Phone: (801) 536-4204:
Fax (801) 615-5311
E-mail: lscanlan@dep.state.ut.us
Contact: Larry P. Scanlan, Environmental Scientist III

1.2.5 U.S. Environmental Protection Agency

The EPA through its Office of Research and Development has financially supported and collaborated with NSF under Cooperative Agreement No. CR 824815. This verification effort was supported by the Drinking Water Treatment Systems Pilot operating under the ETV Program. This document was peer reviewed and reviewed for technical and quality content by the EPA.

1.2.6 Park City Municipal Corporation, Spiro Tunnel Water Filtration Plant

Park City Municipal Corporation personnel performed non-supervisory labor associated with the operation and monitoring of equipment under direct supervision of Peter Cartwright. These activities included collection of operating data, collection of analytical samples and speciation of arsenic samples.

Contact Information:

Park City Municipal Corporation
445 Marsac Avenue
P.O. Box 1480
Park City, Utah 84060
Phone: (435) 615-5310:
Fax (435) 615-4904
Public Works Director: Jerry Gibbs, P.E.

The address of the testing site is:

Spiro Tunnel Water Filtration Plant
1884 Three Kings Drive
Park City, Utah 84060
Phone: (435) 615-5321:
Fax (435) 658-9022
Contact: Rich Hilbert

1.3 Verification Testing Site

The site selected for challenge testing of the Hydranautics ESPA2-4040 Reverse Osmosis Membrane Element Module was the Park City Spiro Tunnel Water Filtration Plant, 1884 Three Kings Drive, Park City, Utah 84060.

The Park City Municipal Corporation has direct access to Spiro Tunnel Bulkhead water. This water source was used for verification testing. A schematic of the Spiro Tunnel Water Filtration Plant is attached (Figure 1-1).

1.3.1 Water Source

The Spiro Tunnel Bulkhead source is considered a groundwater source under the State of Utah source protection program. It is located at N40° 41' 20.8" and W111° 31' 25.0". Water is developed from water bearing fissures in an abandoned silver mine tunnel. At approximately 13,600 feet into the tunnel, a five foot high bulkhead has been constructed to hold back a quantity of water. This water exits the tunnel through a 12" diameter pipe at a flow rate of 1,150 gpm and enters the treatment plant that is located about 300 yards away. The tunnel is located 1,000 feet or more under remote unoccupied forest in a mountainous region, and the tunnel entrance is approximately 50 feet below the bulkhead. There is no use of manmade chemicals on the ground above this source.

The water source used for this test is known as the Spiro Tunnel Bulkhead source, and is stable with respect to quality and quantity. Because this water source contains arsenic, for the municipal supply, it was diluted with the treatment plant finished water to form a blend that met the arsenic standard during the time of testing. For this test, only the untreated, unblended Spiro Tunnel Bulkhead supply was used.

The treatment plant was built in February, 1993, has nominal capacity of 1,000 gpm, and is designed to remove iron, manganese and arsenic from the raw water. This source is one of five active sources serving the municipality: 2 tunnels, 2 deep wells, and a spring. The water system serves 6,500 residents, and as much as 20,000 people per day during the winter season.

Spiro Tunnel Bulkhead water quality before treatment is listed in Table 1-1. These data are historical and not ETV verified. This table is a summary of water quality data contained in Appendix A.

Influent water quality to the Hydranautics ESPA2-4040 Reverse Osmosis Membrane Element Module was verified during both the initial operations period and during the verification test period. The analytical results showing the influent water quality are presented in Chapter 4.

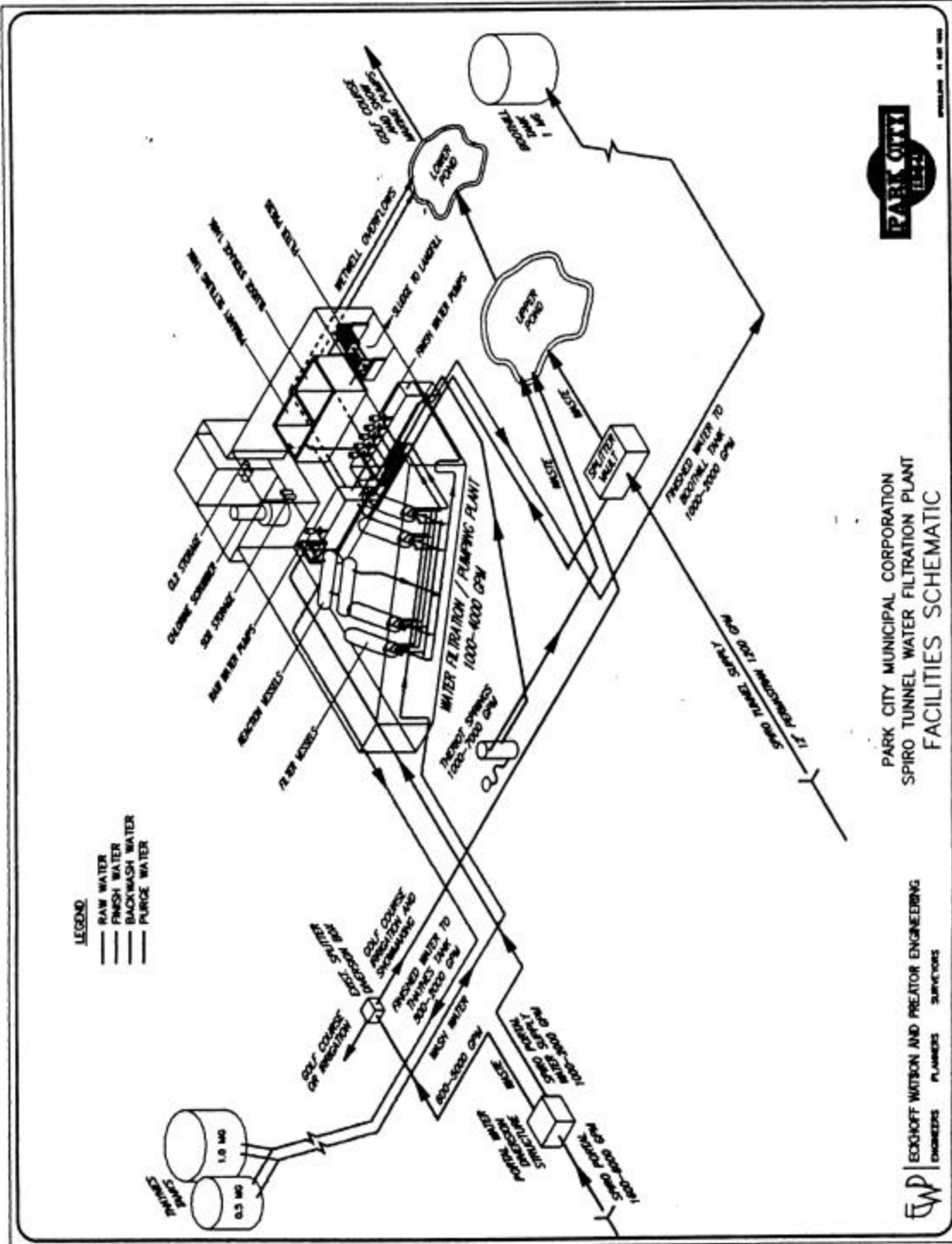

Figure 1-1: Schematic of Spiro Tunnel Water Filtration Plant.

Table 1-1: Historical Spiro Tunnel Bulkhead Untreated Water Quality

Parameter	Minimum	Maximum
pH	7.3	8.2
Total Dissolved Solids (mg/L)	520	660
Total Arsenic (ug/L)	4	225
Turbidity (NTU)	1	4
Total Alkalinity (mg/L as CaCO ₃)	140	152
Total Hardness (mg/L as CaCO ₃)	420	680
Total Iron (mg/L)	0.07	2.7
Calcium (mg/L as Ca)	106	160
Chloride (mg/L)	1	10
Sulfate (mg/L)	260	450
Manganese (ug/L)	5	30
Antimony (ug/L)	6	<100
Beryllium (ug/L)	<1	5
Cadmium (ug/L)	<1	<24
Cyanide (ug/L)	<2	5
Nitrite (NO ₂) (mg/L)	<0.01	<0.02
Nitrate (NO ₃) (mg/L)	<0.02	8.15
Selenium (ug/L)	<1	<5
Thallium (ug/L)	<2	<500
Mercury (ug/L)	<0.2	<1.1

1.3.2 Pilot Effluent Discharge

Concentrate water generated during the verification testing was quantified, sampled and discharged to the Snyderville Sewer Improvement District. A discharge permit was not required.

1.4 Arsenic Chemistry

Arsenic is the 20th most abundant element in the earth’s crust and is a component of over 245 minerals. Because the physical appearance of arsenic resembles that of a metal, it is classified as a metalloid and

is located in group V of the Periodic Table. It readily forms both oxide and sulfide compounds in the environment.

Arsenic enters the environment as the result of both manufacturing and natural processes. Arsenic trioxide (As₂O₃) is formed during smelting operations and has created significant air and land pollution problems. Arsenic also is released through the burning of certain fossil fuels and volcanic eruptions.

In natural waters, soluble arsenic is virtually always present in the oxidation states of either +3(III) or +5(V) valence. An organic species (methylated) has been detected; however, concentrations of this organic compound rarely exceed 1ppb and it is considered of little or no significance as a drinking water contaminant.

In oxygenated waters, the As (V) valence is dominant, existing in the anionic forms of H₂AsO₄⁻, HAsO₄⁼ and AsO₄⁻³. In waters containing little or no oxygen (anoxic), As (III) exists in the nonionic form, H₃AsO₃ below a pH of 9.22, and the anionic form, H₂AsO₃⁻ at a pH above 9.22.

The Table 1-2 lists the properties of selected inorganic arsenic compounds.

Table 1-2: Selected Inorganic Arsenic Compounds

Property	Arsenic	Arsenic Trioxide	Sodium Trioxide	Sodium Arsenate
Synonyms	Arsenic black, colloidal arsenic, gray arsenic	Arsenic oxide, arsenious acid, arsenious oxide, white arsenic	Disodium arsenate, sodium biarsenate, arsenic acid disodium salt	Arsenious acid sodium salt, sodium metaarsenite
Chemical formula	As	As ₂ O ₃ (As ₄ O ₆)	Na ₂ HAsO ₄	NaAsO ₂
Molecular weight	74.92	197.84	185.91	129.91
Valence state	0	3	5	3
Water Solubility	Insoluble	Soluble 37 g/L at 20°C 101 g/l at 100°C	Soluble	Very Soluble

1.4.1 Health Concerns

Arsenic has significant notoriety as a poison, even featured in a stage play, “Arsenic and Old Lace”. Recent studies have indicated that arsenic in drinking water is more dangerous than previously thought, with risks to exposure comparable to that of radon and second hand tobacco smoke. In humans, ingested arsenic can cause liver, lung, kidney, bladder and skin cancers. Arsenite [As (III)] is significantly more toxic than arsenate [As (V)].

1.4.2 Regulatory

The USEPA MCL (Maximum Contaminant Level) for arsenic in drinking water was 50 ppb (50 ug/L) prior to January 22, 2001. The arsenic MCL was lowered to 10 ug/L in a rule promulgated on January 22, 2001.

Data had been under review by the USEPA for several years prior to issuing the new standard. On March 20, 2001, EPA announced that they were proposing to withdraw the new arsenic standard and seek an independent review of the science behind the standard and the costs associated with implementing the new rule. The USEPA indicated that they believe that the arsenic standard needs to be revised and lowered below the current 50 ug/L level, but that they need to review if it is necessary to set the standard as low as 10 ug/l. The World Health Organization (WHO) has established a provisional arsenic limit of 10 ug/L.

The U.S. Geological Survey has prepared a map that identifies the location and concentration of arsenic contaminated groundwater sites in the United States. This map can be accessed on www.usgs.gov.

EPA information on arsenic can be accessed on www.epa.gov/safewater/arsenic.html.

Chapter 2 Equipment Description and Operating Processes

2.1 Equipment Description

The characteristics of the Hydranautics ESPA2-4040 Reverse Osmosis Membrane Element Module are described in Table 2-1. Data sheets for this element are included in Appendix B.

The element was enclosed in a Codeline®U4B membrane pressure vessel. The Codeline® U4B Membrane Pressure Vessel is part of the Hydranautics ESPA2-4040 Reverse Osmosis Membrane Element Module.

The verification testing of the Hydranautics ESPA2-4040 Reverse Osmosis Membrane Element Module was performed on a skid mounted Hydranautics ROSY-200 pilot test unit, equipped with a Goulds G & L pump, model 25VBK11, with a 5 HP motor, operating on 230/460 voltage and drawing 13 amperes. The ROSY-200 pilot test unit is illustrated in Figure 2-1 and in the following photographs.

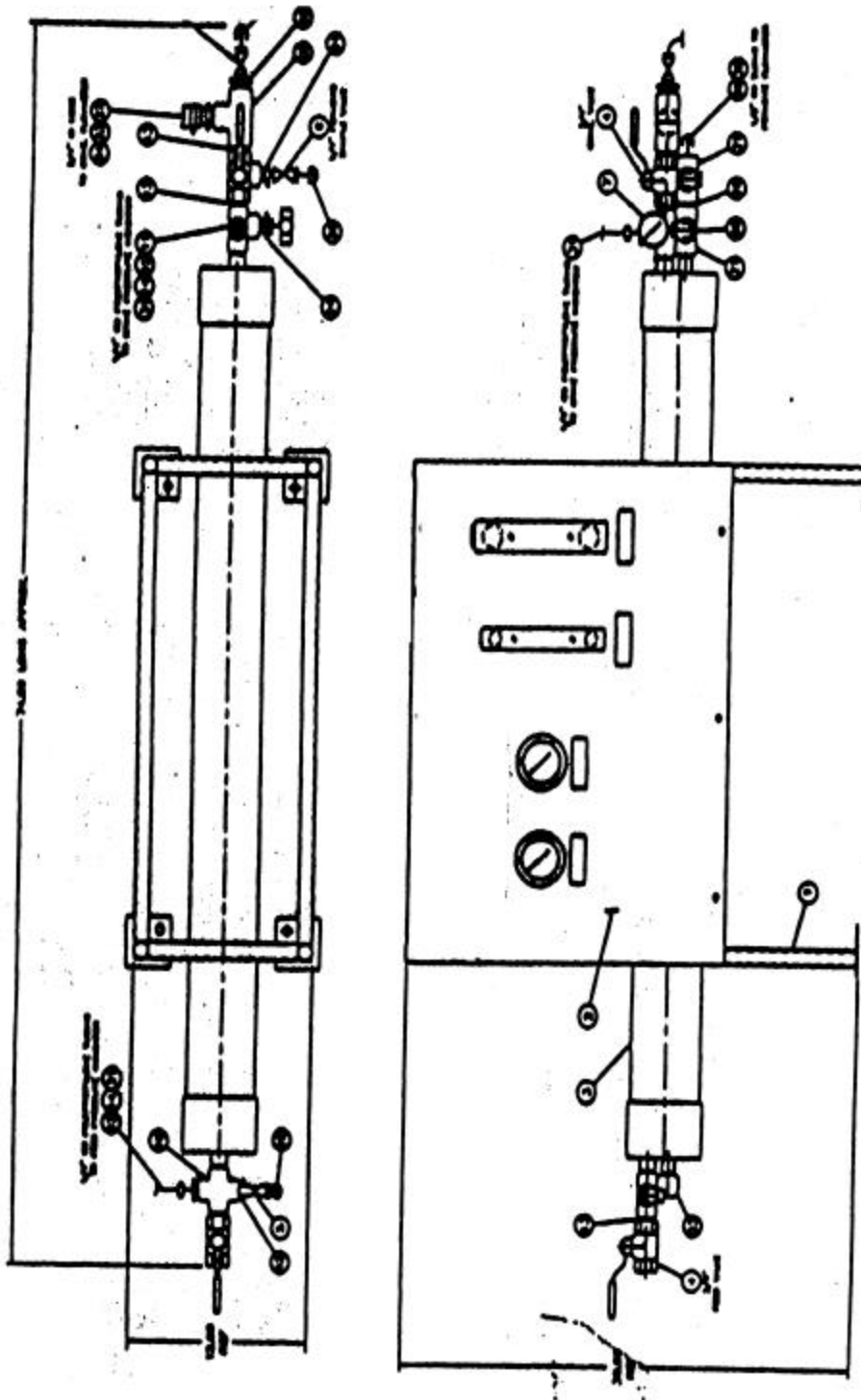

Figure 2-1: ROSY-200 Testing Unit



Photograph 1: Membrane Element Module Test Unit showing prefilter housing and high pressure pump



Photograph 2: Membrane Element Module Test Unit showing prefilter housing and high pressure pump



Photograph 3: Membrane Element Module Test Unit showing feed end of module



Photograph 4: Membrane Element Module Test Unit showing permeate and concentrate end of module

The manufacturer claims that the Hydranautics ESPA2-4040 is a Reverse Osmosis Membrane Element Module capable of achieving a minimum of 98% total arsenic removal from raw water supplied during operation at a flux of 22 gfd (896 Lmd) at a pressure of 150 psi and recovery of 15% at 25°C, and containing as much as 225 micrograms/liters of total arsenic. The manufacturer's claims to achieve a minimum of 98% TDS reduction when operated under the same conditions on a feed water TDS of 1500 mg/l or less.

For this verification testing, the Hydranautics ESPA2-4040 Reverse Osmosis Membrane Element Module was operated at approximately 15% recovery, meaning that 15% of the feedwater flow rate would pass through the membrane and become permeate; the remaining 85% of the feedwater flow rate exits the membrane element as the concentrate stream.

A 5 micron cartridge filter was installed before the feed pump to the Reverse Osmosis Membrane Element Module. This pretreatment filter is not part of the basic Hydranautics Membrane Element Module. However, it is well recognized that RO Membranes typically require some type of pretreatment equipment to protect the membranes from suspended solids or turbidity spikes. The exact nature of the pretreatment process or equipment will be highly site specific depending on the water source and the variability of the source water. For this installation the manufacturer selected a 5 micron disposable cartridge filter as the pretreatment device.

Among the relevant factors in the verification process are costs associated with the Hydranautics ESPA2-4040 Reverse Osmosis Membrane Element Module. Operating conditions were recorded to allow reasonable prediction of performance under other, similar conditions. The specific parameters included power and consumable (such as prefilter cartridge) supply requirements, waste disposal, budget for chemical cleaning, and the length of operation cycle.

Table 2-1: Hydranautics Membrane Element Module Characteristics

Parameter	Value
Membrane Manufacturer	Hydranautics
Membrane Element Module Number	ESPA2-4040
Size of Element Used (in)	4x40
Active Membrane Surface Area per Element (FT ²)	85
Active Surface Area of Equivalent 8"x40" (FT ²)	400
Molecular Weight Cut-Off (daltons)	300-500
Membrane Material Construction	Composite Polyamide
Membrane Hydrophobicity	Hydrophilic
Reported Membrane Charge	Negative
Spacer Thickness (in)	0.026
Scroll Width (ft)	3.33
Design Pressure (psi)	150
Design Flux at Design Pressure (gfd)	22
Variability of Design Flux (%)	±15
Design Specific Flux (gfd/psi) at 25°C	0.24
Standard Testing Recovery (%)	15
Standard Testing pH	6.5-7.0
Standard Testing Temperature (°C)	25
Design Cross-Flow Velocity (ft/s)	-
Maximum Flow Rate to an Element (gpm)	16
Minimum Flow Rate to an Element (gpm)	3
Required Feed Flow to Permeate Flow Ratio	6.6:1
Maximum Element Recovery (%)	20
Rejection of Reference Solute and Conditions of Test	99.5% NaCl (1500 ppm)
Variability of Rejection of Reference Solute (%)	+5-0
Acceptable Range of Operating Pressure (psi)	600 (max.)
Acceptable Range of Operating pH Values	3-10
Typical Pressure Drop over a Single Element (psi)	4
Maximum Permissible SDI	5.0
Maximum Permissible Turbidity (NTU)	1
Chlorine/Oxidant Tolerance (ppm)	0
Suggested Cleaning Procedures	See Appendix B

2.2 Operating Processes

The pressure membrane technologies of microfiltration, ultrafiltration, nanofiltration and reverse osmosis are widely used in water treatment applications ranging from potable water production to ultrapure water purification.

In particular, membrane technologies possess certain properties that make them unique when compared to other solid/liquid separation operations. These include:

- Continuous process, resulting in automatic and uninterrupted operation.
- Low energy utilization involving neither phase nor temperature changes.
- Modular design - no significant size limitations.
- Minimal moving parts with low maintenance requirements.
- No effect on form or chemistry of contaminants.
- Discrete membrane barrier to ensure physical separation of contaminants.
- No chemical additions required to effect separation.

Membrane technologies are among the most versatile water treatment processes with regard to their ability to effectively remove the widest variety of contaminants at the lowest costs. Simply put, these technologies are continuous filters. The form of contaminant removed is a function of membrane polymer selection and its pore size.

The development in filtration technology known as “crossflow” or “tangential flow” filtration allows for continuous processing of liquid streams. In this process, the bulk solution flows over and parallel to the filter medium and exits the system as concentrate. Under pressure, a portion of the water in the bulk solution is forced through the filter medium (membrane) becoming “permeate”. Turbulent flow of the bulk solution across the surface minimizes the accumulation of particulate matter on the filter surface and facilitates continuous operation of the system.

Figure 2-2 compares the crossflow mechanism with conventional filtration.

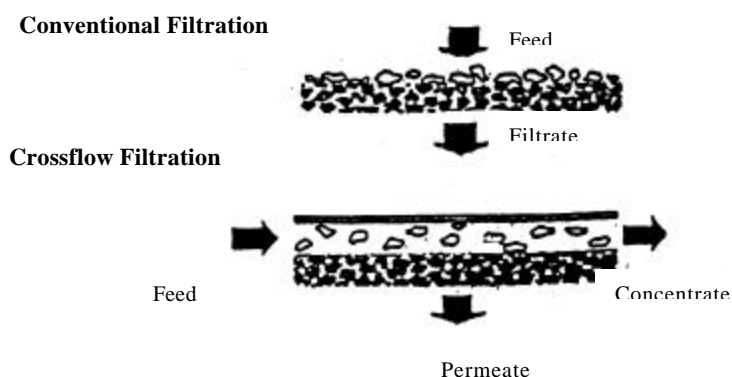

Figure 2-2: Conventional vs. Crossflow Filtration

Reverse osmosis is the crossflow filtration process that produces the highest quality permeate of any pressure driven membrane technology. Certain polymers will reject more than 99% of all ionic solids, and have molecular weight cut-offs in the range of 50 to 100 daltons. Figure 2-3 illustrates reverse osmosis.

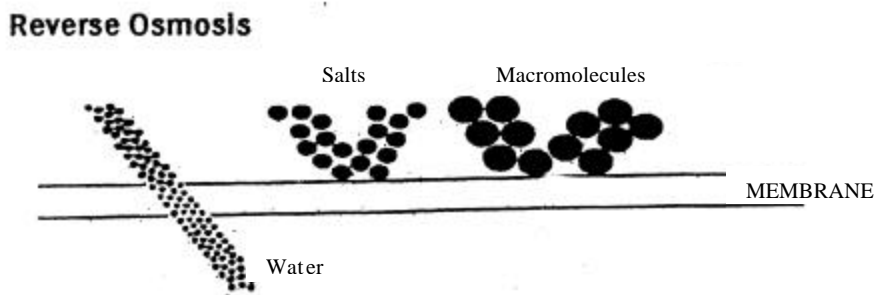

Figure 2-3: Reverse Osmosis

RO membranes reject salts utilizing a mechanism that is not fully understood. Some experts endorse the theory of pure water preferentially passing through the membrane; others attribute it to the effect of surface charges of the membrane polymer on the polarity of the water immediately adjacent to the membrane surface. Monovalent salts are not as highly rejected from the membrane surface as multivalent salts; however, the high rejection properties of thin film composite RO membranes exhibit very little difference in salt rejection characteristics. In all cases, the greater the range of contaminant removal the higher the pressure requirement needed to effect this separation. In other words, reverse osmosis, which separates the widest range of contaminants, requires an operating pressure that is an order of magnitude higher than microfiltration, which removes only suspended solids.

The removal characteristics of reverse osmosis membranes are always based on a percentage of the salts in the feed stream layer immediately adjacent to the membrane surface. The actual concentration of salts in this layer is dependent upon a number of factors such as the concentration of salts in the feed stream, system recovery, concentration polarization effects and turbulent flow through the membrane element.

The water passage through the reverse osmosis membrane (to generate permeate) is known as “flux”. It is a function of applied pressure, water temperature and the osmotic pressure of the solution under treatment. Flux rate is expressed as GFD (gallons per square foot per day) or LMD (liters per square meter per day). Increasing the applied pressure will increase the permeate rate, however, a high flow rate of water through the membrane will tend to promote more rapid fouling. Membrane element manufacturers usually provide limits with regard to the maximum applied pressures to be used as a function of feedwater quality and other factors.

2.3 Equipment Capabilities

The purpose of this test was to verify the performance of the Hydranautics ESPA2-4040 Reverse Osmosis Membrane Element Module in a formal and comprehensive manner to offer state and local public health professionals an opportunity to evaluate the system for specific arsenic removal applications.

The Hydranautics ESPA2-4040 Reverse Osmosis Membrane Element Module has a rated NaCl removal capability of 98% (+/-5). Since reverse osmosis membranes will typically remove multivalent ions to a greater degree than monovalent ions and because two of the three As (V) forms in the feed water are multivalent, it is reasonable to assume that the removal of arsenic in this supply would be at least 98%.

As water recovery is increased, the concentration of salts within the concentrate stream increases exponentially. For example, at 15% recovery, the concentration of salts exiting the membrane in the concentrate stream is approximately 18% higher than in the feed stream; at 50% recovery, the concentration is 100% higher; while at 80% recovery, the concentration is 500% higher.

This increased salts concentration effect can have adverse effects upon membrane performance in two areas: fouling (a) and osmotic pressure (b).

- a. As salts become more concentrated within the membrane element, certain sparingly soluble species may precipitate and foul the membrane surface. In most cases, precipitation of these species can be minimized by adding anti-scalants or by pH adjustment, but it does present a potential design problem in the application of reverse osmosis technology to drinking water treatment.
- b. Osmotic pressure ($\Delta\pi$) is the thermodynamic resistance of a solute/solvent system to solvent passage through the membrane. In other words, the higher the ionic concentration of a stream, the greater its osmotic pressure and the higher the pumping pressure required to produce permeate at a reasonable flow rate. Osmotic pressure effects can be illustrated by the desalination of seawater by reverse osmosis. A pumping pressure of approximately 400 psi is required to generate any permeate flow. For practical purposes, a pumping pressure of 800-1000 psi is required on seawater supplies to generate a reasonable permeate rate.

The osmotic pressure of a solution is a function of both the specific solute and its concentration; however, the osmotic pressure estimation of 1 psi/100ppm for monovalent salts and $\frac{1}{2}$ psi/100ppm for multivalent salts can be safely applied.

Because salts concentrations increase as recovery is increased, for high TDS water, high recovery systems require higher pumping pressure, thereby imposing design limitations, with a maximum practical pressure limit of 1,000 psi.

For the Park City Spiro Tunnel Bulkhead water supply, the maximum recorded TDS level of 670 mg/l would, under worst case conditions, have an osmotic pressure of 6.7 psi, and at a total system recovery as high as 50%, result in a concentrate osmotic pressure of just over 13 psi. This is insignificant in this case, and can be easily accommodated in the selection of the feed (high pressure) pump.

A significant advantage of membrane processes over traditional water treatment technologies is that they will also reduce the concentration of other ionic contaminants as well as high molecular weight organic compounds and suspended solids.

In the Spiro Tunnel Bulkhead water supply, the maximum total arsenic concentration measured to date was 225 $\mu\text{g/L}$, however, this level was not detected during verification. The USEPA MCL, prior to January 22, 2001 was 50 $\mu\text{g/L}$. On January 22, 2001 a new MCL of 10 $\mu\text{g/L}$ was promulgated. This new standard is currently under review by USEPA. With one exception (suspected as being a sampling error), the total arsenic concentration in the permeate stream was consistently less than 1 $\mu\text{g/L}$ during the testing.

This module also reduced the concentrations of TDS, total hardness, sulfate, and antimony in this water supply, allowing them to meet the recommended or statutory regulatory limits, which had been exceeded for these parameters in one or more historical readings.

During the one-month verification testing period, significant changes in the quality of the Spiro Tunnel Bulkhead water supply were not encountered; however, reverse osmosis membrane technology is very tolerant of water quality variations. For example, if the TDS were to increase from 660 to 6600 mg/L, the osmotic pressure would increase to 66 psi, and, at the current operating pressure of 150 psi, the permeate would drop by 44%. No other effect on system performance would be expected, and the permeate rate could be recovered by increasing the pump pressure by 66 psi.

The following Figure 2-4 is the process flow for the verification test.

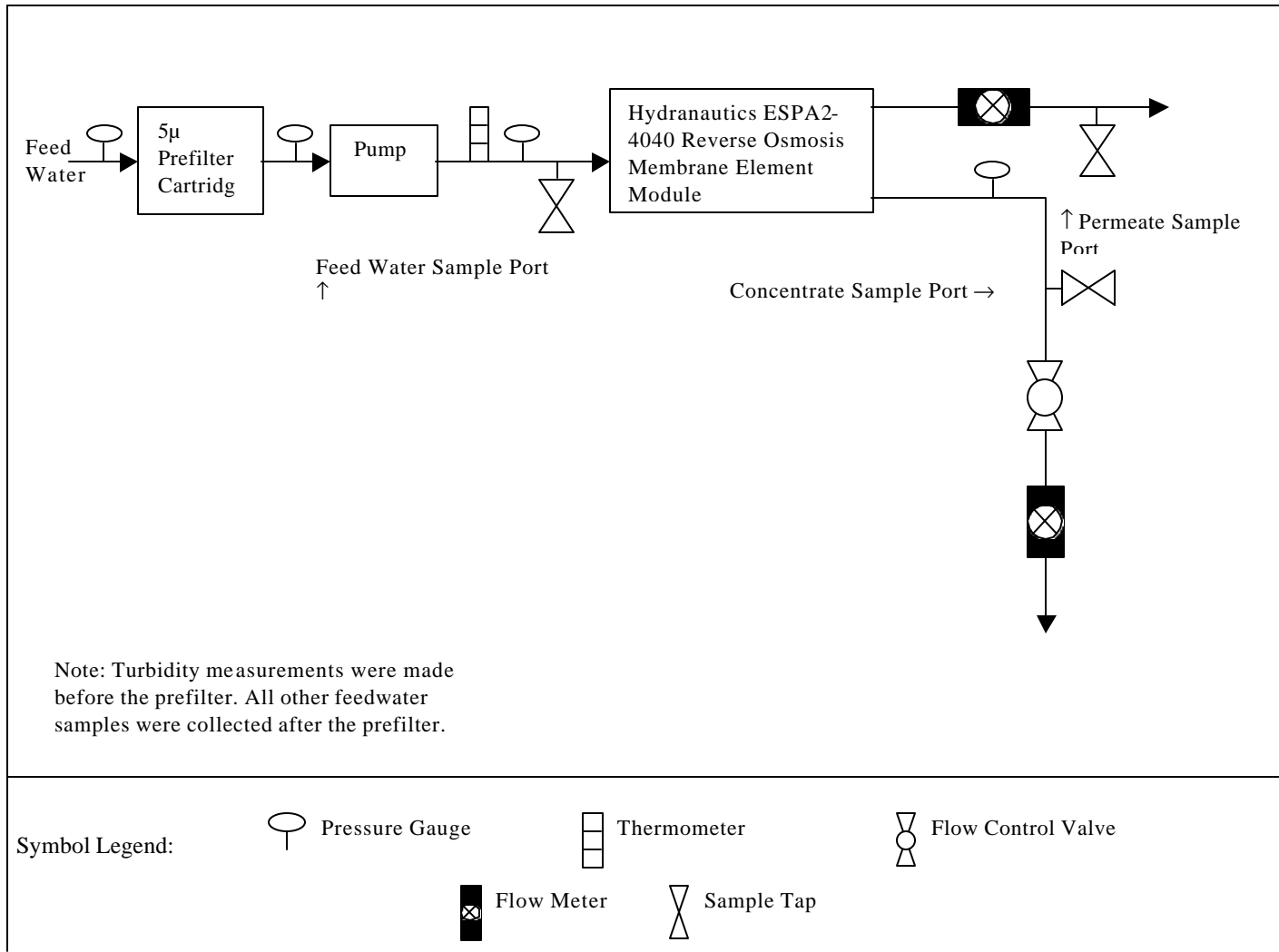

Figure 2-4: Process Flow Diagram

The greatest single cause of membrane element failure is excessive fouling – the accumulation of suspended or precipitated solids on the membrane surface to such an extent as to inhibit water passage through the membrane and into the permeate stream. Providing sufficient pretreatment and utilizing sound system design principles can minimize fouling; however, it cannot be prevented. As a result, virtually all reverse osmosis systems require eventual chemical cleaning as part of the routine preventive maintenance.

Chapter 3 Methods and Procedures

3.1 Experimental Design

This verification study was developed to provide accurate information regarding the performance of the Hydranautics ESPA2-4040 Reverse Osmosis Membrane Element Module. Because of the unpredictability of environmental conditions and mechanical equipment performance, this document should not be viewed in the same light as scientific research conducted in a controlled laboratory setting.

3.1.1 Objectives

The verification testing was undertaken to evaluate the performance of the Hydranautics ESPA2-4040 Reverse Osmosis Membrane Element Module for arsenic reduction. Specifically evaluated were Hydranautics's equipment capabilities and equipment performance relative for the removal of arsenic to help communities meet a revised MCL. Total dissolved solids, antimony, and several other constituents were tested to evaluate the rejection capability of the equipment for these parameters.

An overall evaluation of the operational requirements of the Hydranautics ESPA2-4040 Reverse Osmosis Membrane Element Module was undertaken as part of this verification. This evaluation was qualitative in nature. The manufacturer's Operations and Maintenance (O&M) manual and experiences during the daily operation were used to develop a subjective judgment of the operational requirements of this system. The O&M manual is attached to this report as Appendix B.

Verification testing also evaluated the maintenance requirements of the module. Not all of the maintenance requirements were necessary to be implemented because of the short duration of the testing cycle. The O&M manual details various maintenance activities and their frequencies. This information, as well as experience with common pieces of equipment (i.e., pumps, valves, etc.), was used to evaluate the maintenance requirements.

3.1.2 Equipment Characteristics

The qualitative, quantitative and cost factors of the tested equipment were identified, in so far as possible, during the verification testing. The relatively short duration of the testing cycle created difficulty in reliably identifying some of these factors. The qualitative factors examined during the verification were operational aspects of the Hydranautics ESPA2-4040 Reverse Osmosis Membrane Element Module; for example, susceptibility to changes in environmental conditions, operational requirements and equipment safety, as well as other factors that might impact performance. The quantitative factors examined during the verification testing process were costs associated with the system. Especially important were power; consumable (such as filter cartridge) supply requirements; cost of operation and waste disposal; budget for preventive maintenance; and the length of operation cycle. The operating conditions were recorded to allow reasonable prediction of performance under other, similar conditions. Also noted and reported were any occasional, anomalous conditions that might require operator response. It is important to note that the figures discussed here are for the Hydranautics ESPA2-4040

Reverse Osmosis Membrane Element Module. This Module operated at a specific flux of 0.15-0.16 gfd/psi at 25°C. Costs may change under other operating conditions.

3.1.3 Water Quality Data Collection and Analysis

In the Park City Spiro Tunnel Bulkhead water source, almost all of the arsenic is in the soluble arsenate (V) form (see ChemTech-Ford letter in Field Operations Document, Appendix A). The water quality characteristics that were recorded and analyzed during the verification are listed in Table 3-1, below.

Table 3-1: Analytical Data Collection Schedule

Parameter	Sampling Frequency	Test Stream	Standard Method	Location
pH	1/day	Feed, perm., conc.,	4500H+	on-site
Temperature	2/day	feed	2550B	on-site
Conductivity	2/day	Feed, perm., conc.	2510B	on-site
TDS	2/week	Feed, perm., conc.	2540C	lab
Alkalinity	1/month	Feed, perm., conc.	2320B	lab
LSI	1/month	Feed, perm., conc.	-	lab
Turbidity	1/month	Feed, perm., conc.	2130B	on-site
TSS	1/month	Feed, perm., conc.	EPA 160.2	lab
Silica	1/month	Feed, perm., conc.	EPA 370.1	lab
TOC	1/month	Feed, perm., conc.	5310B	lab
SDI	1/month	feed	ASTM D 4189-95	on-site
Fluoride	1/week	Feed, perm., conc.	4500C	lab
Iron	1/week	Feed, perm., conc.	EPA 200.7	lab
Manganese	1/week	Feed, perm., conc.	EPA 200.7	lab
Sulfate	1/week	Feed, perm., conc.	EPA 375.2	lab
Antimony	1/day	Feed, perm., conc.	EPA 200.8	lab
Arsenic (total)	1/day	Feed, perm, conc.	EPA 200.8	lab
Arsenic (dissolved)	1/day	Feed, perm, conc.	EPA 200.8	lab
Arsenic III	1/day	Feed, perm., conc.	EPA 200.8	lab
Arsenic V	1/day	Feed, perm., conc.	EPA 200.8	lab

Analytical samples were collected daily from the feed, concentrate and permeate streams and speciated in order for the State Laboratory to measure total arsenic, dissolved arsenic, As III and As V, as well as antimony. The arsenic speciation procedure is detailed in Appendix C; it involved filling 3 containers as follows: bottle A - as collected; bottle B – filtered through 0.45µ filter; bottle C – part of the filtered sample processed though an ion exchange resin to remove ionic arsenic, which is assumed to be all As (V).

Daily samples were taken beginning on March 15, during Initial Operations and through April 17, when the test was completed. (Total test period = 34 days).

Table 3-1 lists the continuous, daily, and semi-weekly water quality analyses that were recorded. Daily on-site analyses were recorded in the On-site Logbook and Laboratory Notebook; semi-weekly analyses were recorded in the On-site Logbook and also recorded on separate laboratory report

sheets. These data are summarized in Chapter 4 and the analytical reports are attached to this report as Appendix D.

3.2 Recording Data

The chemical parameters and operating data were maintained in the On-site Logbook and transferred to computer spreadsheets. All readings were manually logged.

The conductivity results for the feedwater, permeate and concentrate streams were used to calculate the ionic strength of the feedwater and concentrate streams, as well as osmotic pressure gradient across the membrane on a daily basis. These data were converted to TDS equivalent data. Osmotic pressure gradient values were then used for calculation of net driving pressure and specific flux on a daily basis. Mass balances for specified water quality parameters were also calculated at least once per week.

Operational data were collected and recorded for each day of the testing cycle. The operational parameters and frequency of the readings are listed in Table 3-2 below.

Table 3-2: Operational Data Collection Data

Parameter	Frequency
1. permeate flow rate (gpm)	2 per day
2. concentrate flow rate (gpm)	2 per day
3. feed flow rate (1+2) (gpm)	2 per day
4. element inlet pressure (psi)	2 per day
5. element outlet pressure (psi)	2 per day
6. element recovery ($1 / (1 + 2) \times 100$) (percent)	2 per day
7. conductivity (feed)	2 per day
8. conductivity (permeate)	2 per day
9. conductivity (concentrate)	2 per day
10. feed temperature (°F)	2 per day
11. osmotic pressure* (Δp) (psi)	2 per day
12. power consumption (kwh)	2 per day

* Based on conductivity readings.

3.3 Communications, Logistics and Data Handling Protocol

Documentation of study events was facilitated through the use of logbooks, photographs, data sheets and chain of custody forms. Data handling is a critical component of any equipment evaluation testing. Care in handling data ensures that the results are accurate and verifiable. Accurate sample analysis is meaningless without verifying that the numbers are being entered into spreadsheets and reports accurately and that the results are statistically valid.

The data management system used in the verification testing program involved the use of computer spreadsheet software and manual recording methods for recording operational parameters. The following describe how data were managed for each parameter.

3.3.1 Objectives

The objective was to tabulate the collected data for completeness and accuracy, and to permit ready retrieval for analysis and reporting. In addition, the use of computer spreadsheets allowed manipulation of the data for arrangement into forms useful for evaluation. A second objective was the statistical analysis of the data as described in the “NSF/EPA ETV Protocol for Equipment Verification Testing for Arsenic Removal” (EPA/NSF 2000), and in section 3.4 of this report.

3.3.2 Procedures

The above data handling procedures were used for all aspects of the verification test. Procedures existed for the use of the log books used for recording the operational data, the documentation of photographs taken during the study, the use of chain of custody forms, the gathering of in-line measurements, entry of data into the customized spreadsheets and the method for performing statistical analyses.

3.3.2.1 Log Books

Data were collected by COA in bound notebooks and on computer generated charts from the appropriate testing instruments. There was a single field notebook containing all on-site operating data that remained on site and contained instrument readings, on-site analyses and any comments concerning the test run with respect to either the nature of the feedwater or the operation of the equipment.

Each page of the notebook was sequentially numbered and identified as Hydraulics ETV Test. Each completed page was signed by the on-duty FTO staff. Errors were crossed out with a single line and initialed. Deviations from the FOD, whether by error or by a change in the conditions of either the test equipment or the water conditions, were noted in the notebook. The notebook included a carbon copy of each page. The original notebook was stored on-site, and the carbon copy sheets retained by the FTO. This not only eased referencing of the original data, but also offered protection of the original record of results.

3.3.2.2 Photographs

Photographs were logged into the field notebook. These entries included time, date, and identity of the photographer.

3.3.2.3 Chain of Custody

Original chain of custody forms traveled with the samples from the test site to the Laboratory (copies of which are attached as Appendix D). This is more completely described in 3.7.4.

3.3.2.4 Spreadsheets

A back-up copy of the computer data was maintained off site. The database for the project was set up in the form of custom-designed spreadsheets. All data from the Laboratory Notebook and the On-site

Logbook were entered into the appropriate spreadsheet. All recorded calculations were checked at this time. Following data entry, the spreadsheet was printed out and the printout was checked against the handwritten data sheet. Corrections were noted on the hard copies and corrected on the screen, and then a corrected version of the spreadsheet was printed out. The COA operator or engineer performing the entry or verification step initialed each step of the verification process.

Computer data were transferred by the physical transfer of data discs.

3.4 Recording Statistical Uncertainty

Statistical 95% confidence calculations were performed for arsenic (all species), antimony, specific flux, pH, TDS and TDS/Conductivity ratio data. These parameters are considered important operational indicators. Sampling requirements are noted in the work plan below. The formula used for confidence calculations follows:

$$\text{confidence interval} = \bar{X} \pm t_{n-1, 1-\frac{\alpha}{2}} (S / \sqrt{n})$$

where: —

X = sample mean

S = standard deviation

N = number of measurements in data set

t = distribution value with n-1 degrees of freedom

α = the significance level defined for 95% confidence as: $1 - 0.95 = 0.05$.

According to the 95% confidence interval approach, the α term is defined to have the value of 0.05, thus simplifying the equation for the 95% confidence interval in the following manner:

$$95\% \text{ confidence interval} = \bar{X} \pm t_{n-1, 0.975} (S / \sqrt{n})$$

3.5 Verification Testing Schedule

The verification testing commenced on March 15, 2000, and the test unit ran without interruption until April 17, 2000. Operating data were recorded and analytical samples collected twice a day through April 16 as well as the morning of April 17, 2000. During this entire period, the unit was shut down for less than 5 minutes per day to change the 5 μ prefilter cartridges.

The cleaning efficiency task was performed on April 17, 2000.

3.6 Field Operations Procedures

In order to ensure data validity, the specific procedures detailed in the *Field Operations Document Environmental Technology Verification of the Hydranautics ESPA2-4040 Reverse Osmosis Membrane Element Module for the Removal of Arsenic from Drinking Water* were followed. This field operations document was based the NSF/EPA approved protocols for test plan development,

EPA/NSF ETV Protocol of Equipment Verification Testing for Arsenic Removal, Chapter 1 – Requirements for All Studies, dated January 10, 2000 and *EPA/NSF ETV Protocol for Equipment Verification Testing for Removal of Inorganic Constituents*, Chapter 2 – Removal by Reverse Osmosis or Nanofiltration, dated February 25, 2000. This ensured the accurate documentation of both water quality and equipment performance. Strict adherence to these procedures resulted in verifiable performance of the equipment.

3.6.1 Equipment Operations

The operating procedure for the Hydranautics ESPA2-4040 Reverse Osmosis Membrane Element Module is described in the Operations Manual (Appendix B). Analytical procedures are described in the State of Utah Division of Drinking Water Laboratory Quality Assurance Plan (Appendix E).

3.6.1.1 Operations Manual

The Operations Manual for the Rosy-200 pilot test unit was housed on-site and is attached to this report as Appendix B. Additionally, operating procedures and equipment descriptions are described in detail in Chapter 2 of this report.

3.6.1.2 Analytical Equipment

The following analytical equipment was used on-site during the verification testing:

- A Hach 2100P portable turbidimeter (serial number 000100024023) was used for benchtop turbidity analyses.
- Pressure gauges were Ametek 4 ½ glycerin-filled and calibrated. There were four gauge connections on the system, one on each side of the 5µ prefilter cartridges (0-60 psig), one on the inlet side of the membrane module (0-200 psig) and one on the outlet side of the module (0-200 psig).
- An in-line NIST traceable Tel-Tru thermometer was used for the measurement of temperature.
- Flowmeters – because of the poor accuracy of the panel mounted flowmeters on the test unit, all flow rates were measured utilizing the “bucket and stopwatch” method.
- Conductivity readings were taken with a Myron Ultrameter Model 6P (serial #6 EVAL 1), which was calibrated by the manufacturer in March 2000.
- Certification of calibration for the above instruments is in Appendix F.

3.6.2 Initial Operations

Initial operations allowed COA to refine the unit’s operating procedures and to make operational adjustments as needed to successfully treat the source water. No adjustment to the FOD was necessary as a result of the initial operations. The Hydranautics ESPA2-4040 Reverse Osmosis Membrane Element Module was operated for approximately one week (until the start of the verification testing) to establish the optimum treatment scheme.

The major operating parameters examined during initial operations were specific flux, net driving pressure and percent water recovery of the treatment unit.

3.6.2.1 Flux

Permeate production capacity of a membrane system is usually expressed as flux. Flux is the water flow rate through the membrane divided by the surface area of the membrane. Flux is calculated from the permeate flow rate and membrane surface area and is expressed as gfd. The surface area of the Hydranautics membrane used for the verification testing was 85 ft². It is customary to refer to flux normalized to 25°C (77°F). Lower temperatures increase the viscosity of water and decrease the flow of permeate produced from a given membrane area.

Manufacturers of reverse osmosis membrane element modules usually provide graphs or charts of a “Temperature Correction Factor” (TCF) as a function of water temperature. These are based on the equation:

$$\text{TCF} = Q_{25} / Q_t = e^x$$

where:

- TCF = Temperature Correction Factor
- Q_{25} = permeate flow rate @ 25°C (77°F)
- Q_t = permeate flow rate @ temperature t (°C)
- e = 2.71828
- $X = K \left[\left(\frac{1}{273+t} \right) - \frac{1}{298} \right]$
- K = constant based on the membrane polymer

For the Hydranautics ESPA2-4040 Reverse Osmosis Membrane Element Module, K=2700. Hydranautics provides a chart for calculating TCF in Appendix B; however, it was considered to be more accurate to use the equation to calculate the TCF. For a temperature of 49°F (9.444°C), TCF=1.65. This figure was used to normalize the permeate rates to 25°C (77°F) for specific flux calculations.

Because permeate rate (and flux) are affected by the pressure applied to the membrane, another important parameter of the membrane system is specific flux. Specific flux is calculated by dividing the normalized flux of the system by the net driving pressure. The specific flux is expressed in gallons per square foot per day per pounds per square inch (gfd/psi) at 25°C (77°F) (See Operational Formulae, pages xi to xiv).

3.6.2.2 Net Driving Pressure

The pressures of the feed water and concentrate streams were recorded twice per day. The average of feed and concentrate pressure readings minus the average osmotic pressure is the net driving pressure of the system (See Operational Formulae, pages xi to xiv).

3.6.2.3 Percent Water Recovery

In order to calculate the percent water recovery, the permeate rate of the membrane module is divided by the feed rate to the unit. Multiplying this result by 100 equals the percent water recovery of the system (See Operational Formulae, pages xi to xiv).

3.7 Verification Task Procedures

The procedures for each task of verification testing were developed in accordance with the requirements of the *EPA/NSF ETV Protocol for Equipment Verification Testing for Removal of Inorganic Constituents*, Chapter 2 – and *EPA/NSF ETV Protocol for Equipment Verification Testing for Removal of Inorganic Constituents*, Chapter 2 –Testing Plan for the Removal of Inorganic Chemical Contaminants by the Reverse Osmosis or Nanofiltration (EPA/NSF, 2000). The Verification Tasks were as follows:

- Task 1: Membrane Operation
- Task 2: Cleaning Efficiency
- Task 3: Finished Water Quality
- Task 4: Data Handling Protocol

Detailed descriptions of each task are provided in the following sections.

3.7.1 Task 1: Membrane Operation

Membrane operational characteristics were identified in this task. The purpose of this evaluation was to quantify operational characteristics of the membrane element module. Information regarding this task was collected throughout the length of the 34-day verification study.

The objectives of this task were to:

1. Establish appropriate operational parameters
2. Demonstrate the product water recovery achieved
3. Monitor the rate of decline of specific flux over extended operation
4. Monitor raw water quality

Standard operating parameters were established through the use of the manufacturer's O&M Manual and the initial operations of the Rosy-200 pilot test unit. After establishment of these parameters, the unit was operated under those conditions. Operational data were collected according to the schedule presented in Table 3-2.

3.7.1.1 Water Recovery

The range of water recoveries used for the verification study was 13.5 to 15.5%. The manufacturer selected this water recovery after examination of the initial operation data.

3.7.1.2 Applied Pressure

Based on data generated during initial operations, the manufacturer selected a maximum applied pressure to the membrane element module of 150 psig.

3.7.1.3 Prefilter Replacement Frequency

Good engineering practice dictates that the 5 μ prefilter cartridges be changed when the pressure drop across them exceeds 10 psi. During the early portion of the testing schedule, the 2-20" long cartridges were replaced every other day; however, a high turbidity event in the tunnel during the night of April 1st caused a plant shut-down (plant turbidimeter spiked at 11.83 NTU) and almost completely plugged the prefilter cartridges, resulting in a drop in the membrane system pump pressure to 50 psig. From April 2 until the end of the testing activity, the 5 μ prefilter cartridges were changed daily.

3.7.2 Task 2: Cleaning Efficiency

Cleaning efficiency procedures were identified in this task. The objectives of this task were to:

1. Evaluate the effectiveness of chemical cleaning for restoring permeate rate and rejection characteristics of the membrane system.
2. Confirm that the manufacturer's cleaning recommendations are sufficient to restore membrane productivity.

Good engineering practice requires that chemical cleaning of reverse osmosis spiral-wound membrane elements be performed when the pressure drop (feed to concentrate) exceeds 10% or when the percent solute rejection drops by more than 10%. Since neither of these conditions occurred during the verification testing period, chemical cleaning was performed at the conclusion of the 34-day period. The membrane element module was cleaned following the manufacturer's recommendations on April 17, 2000.

The very slight reduction in flux rate was suspected to be primarily as the result of ferric hydroxide fouling; therefore, the cleaning chemical used was a 50 gallon solution of citric acid dissolved in permeate at a concentration of 2% by weight. The cleaning solution was pumped into the membrane housing from a 50 gallon cleaning tank through a 5 μ g/L filter cartridge. The flow rate through the membrane module was 19 gpm at a feed pressure of 10 psig. The Model ROSY-200 pilot test unit was equipped with three way valving to ensure that the permeate and concentrate streams were redirected back to the cleaning tank for recirculation for one hour.

After recirculation of the cleaning solution through the Hydranautics ESPA2-4040 Reverse Osmosis Membrane Element Module, the pump was turned off and the system was allowed to soak for 1.75 hours. Then the membrane element module was rinsed with raw water for 20 minutes and placed back on-line.

The citric acid cleaning solution was directed to the raw water wet well for dilution prior to discharge to the Snyderville Sewer Improvement District.

At the conclusion of the cleaning and immediately after placing the system back on-line, the following operational data were recorded:

- Flow rates
- System recovery
- Temperature
- Specific flux

The following analytical data were taken on the chemical cleaning solution after the membrane module had been cleaned:

- pH
- Temperature
- Total iron
- TDS

Visual appearance of the cleaning solution was also noted. The loss of specific flux was calculated by measuring the ratio of the specific flux at the beginning of the test to the specific flux just before cleaning the membrane. Photograph 5 illustrates the cleaning (CIP) system.



Photograph 5 – CIP unit used for cleaning membrane element modules

3.7.3 Task 3: Finished Water Quality

Procedures for the collection and analysis of finished water quality samples are identified in this task. The purpose of this task was to demonstrate whether the manufacturer's stated treatment capabilities are attainable. The goal of this portion of the ETV test was to determine the equipment's capability to consistently remove total arsenic from feed water.

Testing on finished water was conducted throughout the length of the 34-day run. Procedures for sample collection and analysis, analytical equipment operation, and analytical equipment calibration and calibration results are discussed in Section 3.7.3.1.

3.7.3.1. Sample Collection and Analysis Procedure

Finished water samples were collected and speciated daily for arsenic and antimony. Weekly collection and analysis of finished water samples was performed for TDS (2), fluoride, iron, manganese and sulfate. Monthly samples were collected for analyses of alkalinity, LSI, turbidity, TSS, silica and TOC.

Sample collection and analysis was performed according to procedures adapted from Standard Methods for the Examination of Water and Wastewater, 20th edition, (APHA, et. al., 1998).

3.7.4 Task 4: Data Handling Protocol

Water quality data were collected at the specified intervals during the testing period. The monitoring frequency for the water quality parameters is provided in Table 3-1. This table identifies those parameters that were obtained on-site as well as those which were collected and analyzed at the State Laboratory.

Arsenic samples were taken daily on the feed, concentrate and permeate streams. The samples were then speciated into the insoluble form, As (III) and As (V) on-site prior to submission to the laboratory for analysis.

The conductivity of feedwater, permeate and concentrate streams was used to calculate the osmotic pressure gradient across the membrane on a daily basis, and then converted to TDS equivalent. Osmotic pressure gradient values were used for calculation of net driving pressure and specific flux on a daily basis. Mass balances for specified water quality parameters were also calculated at a minimum of once weekly.

On-site data were manually entered into the On-site Logbook containing preprinted spreadsheets for date, time and each required parameter. As laboratory data were received, they were manually entered into the same logbook. Computer spreadsheets containing these identical data were prepared with Microsoft ® Excel Software and brought up-to-date on a daily basis.

A laboratory research notebook (with carbon copy) was also maintained on-site. Daily notes on operating details, such as times for each activity (filter cartridge replacement, operating data

measurements, analytical sample collection, etc) as well as all observations relating to the testing, were entered into this notebook.

Chain-of-custody forms were obtained from the State Laboratory and filled out with the appropriate COA analytical sample identification. These forms accompanied each sample to the laboratory where computer-generated State Laboratory identification codes were assigned to each sample. Copies of the original chain-of-custody forms with the state-assigned codes were returned to COA for reference to the final analytical results submitted on computer-generated forms (Appendix D). A total of just fewer than 1000 analyses were reported on arsenic alone using this procedure.

3.8 QA/QC Procedures

Establishment and implementation of strict quality assurance and quality control (QA/QC) procedures is important, in that if a question arises when analyzing or interpreting data collected for a given experiment, it will be possible to verify exact conditions at the time of testing. The following QA/QC procedures were utilized during the verification testing.

3.8.1 Instruments with Daily QA/QC Verification Procedures

Daily QA/QC procedures were performed on the bench pH meter and hand-held conductivity monitor.

3.8.1.1 pH Meter

Analyses were made by SM 4500-H⁺. A three point calibration (pH 4, 7, and 10) with NIST traceable pH buffers was performed daily. Between tests, the pH probe was kept wet in KCl solution. For on-site determination of pH, field procedures were used to limit absorbance of carbon dioxide to avoid skewing results by poorly buffered water.

The pH measurements do not lend themselves to “blank” analyses. Duplicates were run once a day. Performance evaluation samples were analyzed during the testing period. Results of the duplicates and performance evaluation were recorded. The unit was also calibrated against a standardized pH instrument in the State of Utah Laboratory and found to be within 5% accuracy.

3.8.1.2 Conductivity Monitor

The hand-held Myron L Ultrameter Model P (serial #6 EVAL) conductivity meter was sent to the manufacturer for calibration prior to the start of verification testing. On a daily basis, the monitor was also calibrated with standard solutions from the manufacturer.

3.8.2 In-Line Thermometer

Temperature was measured in accordance with SM 2550 two times daily at the same time other operational data were gathered. The thermometer read in 1.0°F increments, and was an NIST Traceable thermometer mounted between the high-pressure pump and the membrane element module.

3.8.3 *In-Line Pressure Gauges*

Pressure gauges were originally mounted on the inlet and outlet of the 5 μ prefilter cartridges as well as on the feed and concentrate sides of the membrane element module. An evaluation of the accuracy of these gauges revealed that they all were inadequate, so the gauges were removed and replaced with quick-disconnect fittings to allow all pressure readings to be made with glycerin-filled NIST traceable gauges installed for each reading. The prefilter pressures were read with a 0-60 psig Ametek Model No. 1980L (Certificate # 0084-6); the membrane pressures were read with a 0-200 psig Ametek Model 1980 L (Certificate # 0068-7). Certificates of calibration are located in Appendix F.

3.8.4 *In-Line Flow Meters*

The test unit was equipped with panel mounted acrylic flow meters to read permeate and concentrate flow rates; however, the accuracy of these meters was determined to be too poor to use, so the “bucket and stopwatch” flow rate procedure was utilized for those flow measurements. The permeate and concentrate lines were equipped with three-way valves which allowed the total flow to be diverted for these measurements.

3.8.5 *Turbidity Meters*

Turbidity readings were required only once per month; however, bench turbidimeter readings were taken at the beginning and end of the testing. The benchtop turbidimeter (Hach 2100P) was calibrated at the start of testing and then weekly, during the testing period, against primary standards. Manufacturer’s procedures for maintenance were followed and the schedules for maintenance and cleaning noted in the logbook. All glassware was dedicated and cleaned with lint free tissues to prevent scouring or deposits on the cells. Secondary standards (0.0, 0.4 and 20.0 NTU) were used to calibrate the turbidimeter with each use. *Standard Methods* 2130 was employed for measurement of turbidity.

3.8.6 *Tubing and Fittings*

The tubing and fittings associated with the Rosy-200 pilot test unit were inspected to verify that they were clean and did not have any holes or cracks in them. Also, the tubing was inspected for brittleness or any condition that could cause a failure.

3.8.7 *Off-Site Analysis of Chemical Samples*

3.8.7.1 Organic Parameters (Total Organic Carbon)

Samples for this parameter were collected in glass bottles supplied by the State of Utah Laboratory and were delivered to the laboratory by COA. Samples were preserved, held and shipped in accordance with *SM* 5010B and *SM* 1060.

3.8.7.2 Inorganic Samples

Inorganic samples were collected, held in the refrigerator at 4°C and shipped in accordance with SM 3010B and C and 1060 and EPA §136.3, 40 CFR Chapter 1, every week. Proper bottles and preservatives, where required (iron and manganese for example), were used. Although the travel time was brief, samples were shipped in coolers at 4°C.

3.8.8 *SDI Measurements*

SDI (Silt Density Index) measurements of the feedwater stream were required to be made once per month. The initial reading was taken with a manual SDI unit (Osmonics, Inc.) on March 15, 2000 and another reading with both the manual unit and an Auto SDI unit (Osmonics, Inc.) on April 17, 2000.

The test involves measuring the rate of decay of water flow through a 0.45µ filter disc under a constant pressure (30psi) for a specified length of time. The test was developed under the auspices of the ASTM Committee on Water and assigned a test number ASTM D 4189-95.

The equipment used for the manual SDI measurements was an Osmonics, Inc. SDI Kit, serial No. 00-1113664-34. It requires connecting the water supply and using a stopwatch to collect the time data. On April 17, an Osmonics Auto SDI unit was used to check the manual equipment.

All measurements were made downstream of the 5µ prefilter cartridges, except for one Auto SDI measurement made on April 21, 2000, on the raw feedwater.

Chapter 4 Results and Discussion

4.1 Introduction

The verification testing of the Hydranautics ESPA2-4040 Reverse Osmosis Membrane Element Module, performed at the Park City Utah Spiro Tunnel Water Filtration Plant, commenced on March 15, 2000, and concluded on April 17, 2000. Chemical cleaning was performed on April 17, 2000.

This section of the verification report presents the results of the initial operations period, the verification testing period, and a discussion of the results. Results and discussions include: initial operations, membrane operation, cleaning efficiency, finished water quality and QA/QC.

4.2 Initial Operations Results

4.2.1 *Startup Period*

An initial operations period allowed COA to refine the unit's operating procedures and to make operational adjustments as needed to successfully treat the source water. The primary goals of the initial operations period were to establish an optimum water recovery and operating pressure for the test.

A characteristic of many reverse osmosis membrane elements is that after startup (the first 24 to 48 hours), the flux rate is unusually high. This initial period is known as "flux stabilization" and this flux rate does not reflect the normal operating flux of the element. During the first five days of operation, the unit remained very stable with very little change in permeate rate or specific flux. The permeate flow varied from 0.79 to 0.81 gpm and the specific flux remained constant at 0.16 gfd/psi.

4.2.2 *Water Recovery*

Based on the data collected during the initial operations period, the manufacturer determined that the treatment unit would be capable of operating at a water recovery rate ((permeate flow/feedwater flow)*100) of 15% at the feedwater temperature of 49°F (9.44°C). The actual recovery data calculated from twice-daily flow readings ranged from 13.5% to 15.5% over the duration of the test. The individual flow measurements are presented in Appendix G, as recorded in the On-Site Logbook.

4.2.3 *Operating Pressure*

As defined in the Operational Formulae section of this report, the net driving pressure (NDP) is the average pressure across the membrane minus osmotic pressure and any backpressure. The osmotic pressure calculated from TDS data was less than 10 psi and there was no backpressure on the system. At the specified flow rate, the pressure drop from the feed end to the concentrate end of the module was within specifications and ranged from 3 to 10 psig over the duration of the test. In consultation with the manufacturer, COA determined that the optimum operating pressure for this test was 150 psig. The NDP varied from 132.0 to 142.5 psi during the testing period.

4.3 Verification Testing Results and Discussion

The results and discussions of membrane operation, cleaning efficiency, finished water quality and data handling are presented below.

4.3.1 Task 1: Membrane Operation

The purpose of this evaluation was to quantify operational characteristics of the membrane element module. Information regarding this task was collected throughout the length of the verification study.

Standard operating conditions were established through the use of the manufacturer's O&M Manual and during the Initial Operations period of the verification testing. Operational data were collected according to the schedule presented in Table 3-2.

Osmotic Pressure Gradient

As defined in the Operational Formulae section of this report, the osmotic pressure gradient is normally determined based on the Total Dissolved Solids (TDS) concentrations measured in the feedwater, the concentrate, and the permeate. The osmotic pressure gradient is then used as part of the calculation for determining Net Driving Pressure (NDP). The permeate flow and the NDP are then used to calculate the Specific Flux for the module.

The Test Plan stated that TDS measurements be made by the State Laboratory once per week (in actuality, COA submitted samples twice per week). While twice-weekly TDS data provided a good data set for tracking the TDS levels and the unit performance in treating TDS, it would be preferable to have daily calculations for NDP and Specific Flux. Conductivity, which was monitored in the field on a twice-daily basis, can be used as a surrogate to estimate the TDS concentration.

Conductivity is significantly affected by the characteristics of the specific solute, such as valance, as well as the total concentration. Therefore, conductivity cannot provide an exact determination of TDS concentration. However, given sufficient data on a specific water source, a correlation can be developed between conductivity and TDS that can be used to provide a very good estimate of the TDS concentrations. Conductivity meter manufacturers and other companies involved in the water purification industry have also developed conversion charts and graphs based on a "typical" mix of solute chemistries in water that provide the basis for determining TDS levels from conductivity measurements. Both methods of estimating TDS concentrations can be used, but direct correlation factors developed for a specific water source are generally more accurate than using values based on "typical" water. For this verification test there are eleven sets of TDS data and corresponding conductivity measurements. It was determined that a conversion factor could be developed from this data and the conversion factor could be used to convert conductivity data to TDS concentration.

The conductivity readings, taken closest to the eleven TDS collection times, were divided into the TDS concentrations. These results for the feed and concentrate streams were then averaged to generate a pooled average figure that was then used as a multiplier to convert osmotic pressure calculations to the TDS basis. Table 4-1 provides a summary of TDS data in the feed, concentrate and permeate streams.

The TDS and conductivity data used to determine the conversion factor are shown in Table 4-2. As can be seen in Table 4-3, the correlation between TDS and conductivity did vary somewhat over the data set, but the standard deviation and confidence interval statistics show that the variation was generally quite small. Therefore, the use of the conversion factor of 0.743 was considered to provide a very good estimate of the TDS concentration.

The data and calculations used to develop this multiplier are presented below.

TDS

An important parameter of reverse osmosis membrane performance is TDS rejection, which is the ability of the module to reduce total dissolved solids concentration in a feedwater stream. TDS measurements (by evaporation) were made by the State Laboratory on approximately a twice per week basis (11 measurements in 5 weeks). Table 4-1 provides a summary of TDS data in the feed, concentrate and permeate streams as well as percent rejection. It should be noted that all but one of the permeate data are below the MDL (10 mg/L). Therefore, it was not possible to calculate meaningful statistics for the permeate TDS results. The actual TDS levels in the permeate are below the 10 mg/l level, which indicates that the rejection in most cases is higher than 98%. The raw data used for this summary are in Table 4-2. As expected, the Membrane Element Module removed 98% or better of TDS from the feedwater stream.

Table 4-1: Total Dissolved Solids Summary

	Feed (mg/L)	Concentrate (mg/L)	Permeate (mg/L)	% Rejection
Average	547	647	10	98
Minimum	406	532	<10	98
Maximum	570	670	10	98
Standard Deviation	47.4	39.2	NA	NA
Confidence Interval	(519, 575)	(624, 671)	NA	NA

Conductivity

To provide an indication of TDS concentrations in the feed, concentrate and permeate streams on a daily basis, conductivity measurements were taken with a Myron L Model 6P Ultrameter. For a given solute (or mix thereof), as stated earlier, conductivity can be related to TDS, and the ratio of TDS to Conductivity should be approximately a constant. Table 4-2 compares the conductivity measurements with TDS data and lists the ratio of TDS to Conductivity. Table 4-3 summarizes this data. The variations in the ratios may be attributed to the fact that the conductivity reading and TDS sample collection activities were sometimes separated by several hours. During that time interval, variation in the solute mix in the feedwater may have occurred. The variation in the ratios is quite small as shown by the standards deviation and confidence intervals. Because all but one of the permeate TDS data are below the MDL of 10 mg/L, the ratio (TDS/Conductivity) calculation for this stream is not meaningful. The pooled average conversion ratio (0.743) from the feedwater and concentrate data was used in the calculation for determining Specific Flux on a TDS basis (discussed below).

Table 4-2: Total Dissolved Solids, Conductivity and TDS/Conductivity Ratio vs. Time

Date	Feed			Concentrate			Permeate	
	TDS (mg/L)	Conductivity (µS/cm)	TDS/Cond.	TDS (mg/L)	Conductivity (µS/cm)	TDS/Cond.	TDS (mg/L)	Conductivity (µS/cm)
3/17/00	406	773.2	0.525	666	887.0	0.751	10	4.42
3/20/00	570	771.2	0.739	666	879.6	0.757	<10	4.75
3/23/00	562	768.2	0.732	664	897.3	0.740	<10	4.79
3/27/00	570	775.2	0.735	670	891.5	0.752	<10	8.63
3/29/00	550	704.1	0.781	646	815.2	0.792	<10	7.07
4/4/00	560	745.8	0.751	660	855.0	0.772	<10	7.34
4/5/00	562	753.7	0.746	662	863.7	0.766	<10	5.38
4/10/00	554	691.6	0.801	662	787.7	0.840	<10	4.12
4/13/00	564	763.6	0.739	648	866.8	0.748	<10	4.12
4/17/00	552	748.3	0.738	646	857.5	0.753	<10	4.98
4/17/00	570	748.3	0.762	532	857.5	0.620	<10	4.98

Table 4-3: TDS to Conductivity Ratio Summary

	Feed	Concentrate
Average:	0.732	0.754
Minimum:	0.525	0.620
Maximum:	0.801	0.840
Standard Deviation:	0.0718	0.0525
Confidence Interval:	0.689, 0.774	0.723, 0.785

$$\text{Pooled average} \left(\frac{\text{feed} + \text{concentrate}}{2} \right) = 0.743$$

Specific Flux

Specific Flux is the permeate flux at a constant temperature divided by the Net Driving Pressure, which is the average pressure of the feed and concentrate minus any osmotic pressure and permeate back pressure. In this test, the stream was discharged to atmosphere, so the permeate back pressure was zero. Osmotic pressure data were calculated from conductivity data by averaging the feed and concentrate conductivities, subtracting the permeate conductivity and dividing that figure by 100. These results were then multiplied by the conductivity to TDS conversion factor of 0.743. Thus, all of the NDP results and the Specific Flux results, calculated using the daily NDP values, are based on TDS concentrations.

As discussed in Section 3.6.2.1, flux, which is a method of expressing permeate flow, is customarily normalized to 25°C (77°F) using the formula shown in Section 3.6.2.1. Normalizing the flux to a constant temperature helps to account for the effect that the increased viscosity of water at lower temperatures has on permeate flow through a membrane. The feedwater temperature measured a

steady 49°F (9.44°C) during the testing period. All of the flux data, calculated from measured permeate flow and membrane surface area, were corrected to 25°C. The temperature corrected flux values were then used to calculate specific flux (permeate flux/NDP). Therefore, all of the specific flux results presented in the tables and figures below are based on temperature corrected results and are on a TDS basis.

Table 4-4 lists the daily specific flux data. Table 4-5 summarizes these data and Figure 4-1 illustrates the slight decrease in the specific flux average during the 34-day test period.

Two specific flux data values were calculated each day. For Figure 4-1, the data points for each day were averaged in order to generate the curve.

The raw data from which specific flux values were calculated are in Appendix G, along with a summary of calculation data.

$$\text{Specific Flux} = \frac{\text{Permeate Flux}}{\text{NDP}}$$

(Defined in Operational Formulae, pages xi to xiv)

Table 4-4: Specific Flux Data vs. Time

Date	Specific Flux (gfd/psi)		Date	Specific Flux (gfd/psi)	
	AM	PM		AM	PM
3/15/00	0.16	0.16	4/1/00	0.15	0.15
3/16/00	0.16	0.16	4/2/00	0.15	0.15
3/17/00	0.16	0.16	4/3/00	0.15	0.15
3/18/00	0.16	0.16	4/4/00	0.15	0.15
3/19/00	0.16	0.16	4/5/00	0.15	0.15
3/20/00	0.15	0.15	4/6/00	0.15	0.15
3/21/00	0.15	0.15	4/7/00	0.15	0.15
3/22/00	0.15	0.15	4/8/00	0.16	0.15
3/23/00	0.15	0.15	4/9/00	0.15	0.15
3/24/00	0.16	0.15	4/10/00	0.15	0.15
3/25/00	0.15	0.15	4/11/00	0.16	0.16
3/26/00	0.16	0.16	4/12/00	0.15	0.15
3/27/00	0.16	0.16	4/13/00	0.15	0.15
3/28/00	0.16	0.16	4/14/00	0.15	0.15
3/29/00	0.16	0.15	4/15/00	0.15	0.15
3/30/00	0.15	0.15	4/16/00	0.15	0.15
3/31/00	0.15	0.16	4/17/00	0.15	-
After Cleaning:		4/17/00	0.15		

Table 4-5: Specific Flux Data Summary (gfd/psi)

Average of AM and PM data	0.15
Minimum	0.15
Maximum	0.16
Standard Deviation	0.0029
95% Confidence Interval	(0.15,0.15)

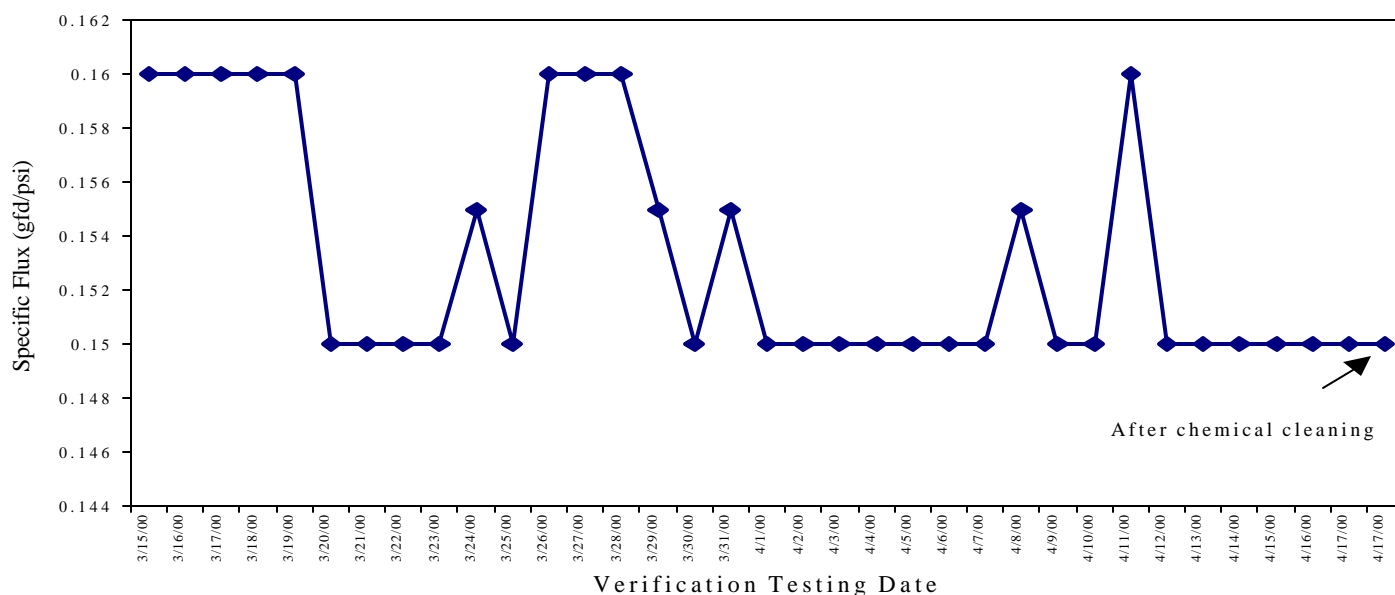

Figure 4-1: Variation of Average Specific Flux Data vs. Time

A drop in specific flux virtually always results from membrane fouling. The presence of fouling materials on the membrane surface inhibits the passage of purified water through the membrane. The specific flux calculation accounts for variations in temperature, pressure drop and osmotic pressure (dissolved solids concentration). Therefore, a change in specific flux reflects a change in permeate rate. The Hydranautics ESPA2-4040 Reverse Osmosis Membrane Element Module exhibited no significant drop in specific flux over the 34-day test period. The very consistent specific flux results and consistent operation of the unit indicates that no significant fouling of the membrane occurred during the test period.

SDI

Silt Density Index (SDI) is a measurement of the quantity of suspended solids in a water supply that could potentially foul reverse osmosis membrane elements. SDI is considered the most reliable “field” measurement technique currently available for predicting the fouling propensity of feedwater supplies to a reverse osmosis membrane. It does however have several limitations, as follows:

- 1) The test operates in the “dead-end” or “once-through” mode, in that the entire water flow passes through the filter disc as opposed to the “crossflow” design of reverse osmosis, more fully described in Chapter 2.
- 2) The pore size of the filter disc is 0.45μ , whereas the pore size of the reverse osmosis membrane is less than 0.002μ , meaning that extremely small sized colloidal material that may foul the reverse osmosis membrane would not show up in the test.
- 3) Because the reverse osmosis process concentrates all salts, it is possible that the solubility limits of some sparingly soluble compounds may be exceeded, resulting in fouling from sources that cannot be measured in the SDI Test.

Table 4-6 lists all of the SDI data, which are also plotted in Figure 4-2.

Table 4-6: Feedwater SDI Measurements

Date	Time	SDI Reading
3/15/00	1810	2.5
3/16/00	1600	6.64
3/17/00	0921	2.1
3/17/00	1905	6.19
3/18/00	0916	5.6
3/18/00	1615	5.8
3/19/00	0818	6.3
3/19/00	1448	7.8
4/17/00	1130	2.7

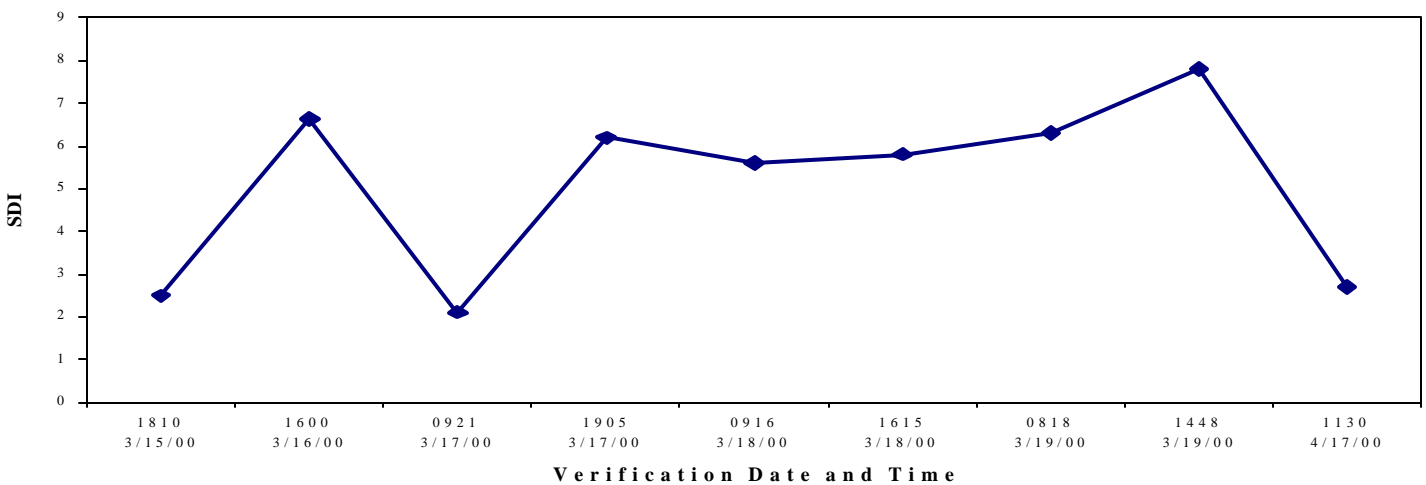

Figure 4-2: Feedwater SDI Measurements vs. Time

The physical appearance of the filter discs does not always correlate with the SDI reading. Photocopies of the several of the discs are presented in Appendix H.

Turbidity

Another parameter that measures insoluble particulate material in water supplies is turbidity. There is a paucity of data relating turbidity to membrane fouling; therefore, SDI is the preferred parameter used in this test. As stated above, SDI is considered a better predictor of membrane fouling than turbidity; however, turbidity is a more common measurement technique used in virtually all water treatment plants. Turbidimeters are used widely in the water industry to monitor changes in water quality due to particulate loading changes in the water supply. The meters are either bench top units, which are easy to use so that frequent measurements are made or they are continuous recording units, capable of providing instantaneous readings twenty-four hours a day. Turbidity readings were recorded from the Treatment Plant wall mounted in-line turbidimeter almost every day, as well as from benchtop

turbidimeter measurement records. Both instruments read the raw water and the sampling points were within 50 feet of each other.

Table 4-7 lists the two sets of readings over the testing period.

Some discrepancies between the in-line and bench-top turbidimeters were noted. Several explanations for these are offered, as follows:

- 1) Difference in the analytical techniques between the in-line and bench-top turbidimeters: The bench-top turbidimeter uses a glass cuvette to hold the sample; this cuvette can present some optical difficulties for this instrument. The in-line turbidimeter has no cuvette to present a possible interference with the optics of the instrument. The low level of turbidity can create analytical difficulties, particularly for the bench-top instrument. Manufacturer's specifications state that stray light interference is less than 0.02 NTU. Stray light interference at the low turbidity levels tested could account for the differences in the readings.
- 2) Normal geologic activity such as portions of the Spiro Tunnel walls and ceiling falling into the water caused short-term turbidity spikes in the feedwater that may have affected the accuracy of the in-line plant turbidimeter between routine cleanings. For example, a turbidity spike occurred at 0300 on April 2, 2000, which shut down the filtration plant (the turbidity alarm level was set at 5.0 NTU). The turbidimeter was cleaned and returned to service.
- 3) Although attempts were made to collect bench-top turbidity samples at the same time that in-line turbidimeter readings were made, the logistics of the sampling locations resulting in small time differences may have resulted in slight changes in water quality between these events.

Because the Spiro Tunnel Bulkhead water upstream of the bulkhead is mainly flowing along the bottom of an open passageway, it is susceptible to disturbances from falling rock and other normal geologic activity. As a result, the level of suspended solids in the feedwater could change drastically during short periods, as evidenced by turbidity spikes recorded by the Spiro Water Filtration Plant turbidimeter from a baseline reading of less than 1 NTU up to a maximum of almost 12 NTU. While these fluctuations can cause short-term treatment difficulties and could cause membrane fouling, there was no evidence that the fluctuations impacted the membrane unit during the test period.

The 0.45 μ filter discs used in the speciation of arsenic samples to collect the "bottle B" analyte provide further evidence that wide fluctuations in suspended solids concentrations can occur in this feedwater. Most of the filter discs were dried and retained. The difference in shades and intensity of the reddish-brown color (presumed to be ferric hydroxide) is very evident in these and photocopies are provided in Appendix H. The varying intensity and shades indicates that particulate present in this water varies not only in concentration but also in chemical characteristics. In spite of these variations, the membrane unit continued to function well and there was no noticeable catastrophic fouling of the membrane. Permeate flow was steady and specific flux remained virtually constant.

Table 4-7: Turbidity Readings (NTU) vs. Time

Date	Raw Water (NTU)	
	Treatment Plant In-Line	Bench
3/15/00	0.78	1.06
3/16/00	1.00	1.10
3/17/00	0.88	0.88
3/18/00	0.89	0.96
3/19/00	2.35, 3.65, 11.79	2.41, --, 11.3
3/20/00	1.00	1.23
3/21/00	-	-
3/22/00	0.82	0.80
3/23/00	1.25	1.08
3/24/00	1.33, 1.26	1.92, 1.83
3/25/00	1.20	1.91
3/26/00	2.43	0.89
3/27/00	0.98	1.44
3/28/00	0.96, 0.90	1.22, 1.16
3/29/00	0.97, 0.87	1.37, 1.41
3/30/00	1.11	0.94
3/31/00	1.17	0.97
4/1/00	1.07	0.95
4/2/00	1.7	1.9
4/3/00	0.98	1.31
4/4/00	1.25	1.75
4/5/00	1.5	1.90
4/6/00	1.4	1.87
4/7/00	1.2	1.4
4/8/00	-	-
4/9/00	1.58	1.96
4/10/00	1.60	1.98
4/11/00	-	-
4/12/00	1.7	2.1
4/13/00	1.80	1.76
4/14/00	1.9	1.4
4/15/00	1.9	1.5
4/16/00	1.36	1.84

4.3.2 Task 2: Cleaning Efficiency

The Hydranautics ESPA2-4040 Reverse Osmosis Membrane Element Module was chemically cleaned utilizing a commercially available CIP unit containing 50 gallons of a 2% (wt/wt) citric acid solution. The cleaning took place in the afternoon of April 17, 2000, following the termination of the verification testing that morning.

After a one-hour recirculation of cleaning solution through the membrane module and a 1¾hour soak, it was rinsed with feed water for approximately ½hour and placed back on line to determine the effectiveness of the cleaning. Table 4-8 summarizes the cleaning process data. Unfortunately, due to a

communication error, samples for TOC analysis were collected from the cleaning solution in containers without the necessary preservative.

Table 4-8: Membrane Element System Cleaning Data

Item	Description
Composition of Cleaning Chemical	Citric Acid
Quantity of Cleaning Chemical	8.5Lb/50gal Permeate (~2% wt/wt Solution)
Feed Flow Rate (gpm)	19.3
System Recovery (%)	14.0
Total Chemical Cleaning Time (hours)	3.25
Recirculation Time (hours)	1.0
Soak Time (hours)	1.75
Rinse Flow Rate (gpm)	5.44
Rinse Time (minutes)	20
Cleaning Temperature (Initial) (°C)	14.6
Cleaning Temperature (Final) (°C)	16.6
Disposal Method of Cleaning Water	Snyderville Sewer Improvement District
Chemical Analysis of Cleaning Solution	
pH	2.61
Temperature (°C)	16.6
TDS (mg/L)	4026
Total Iron (mg/L)	466.0
Specific Flux (Initial) (gfd/psi)	0.15
Specific Flux (Final) (gfd/psi)	0.15
Recovery of Specific Flux	None

At the completion of the cleaning regimen, the membrane module was placed back on line to determine the effect of the cleaning on the module performance. Table 4-9 contains the operating data from this retest, and Table 4-10 lists several performance parameters.

Table 4-9: Operating Data after Cleaning

Parameter	Measurement
1. Permeate Flow Rate (gpm)	0.77
2. Concentrate Flow Rate (gpm)	4.48
3. Feed Flow Rate (1+2)(gpm)	5.25
4. Element Inlet Pressure (psi)	150
5. Element Outlet Pressure (psi)	148
6. Element Recovery ((1/1+2) x100)(%)	14.7
7. Conductivity (Feed) (μS/cm)	742.0
8. Conductivity (Permeate) (μS/cm)	4.76
9. Conductivity (Concentrate) (μS/cm)	862.2
10. Feed Temperature (°F)	49
11. Osmotic Pressure (Δπ)(psi)	8.0
12. Net Driving Pressure (psi)	141.0
13. Specific Flux (@25°C)(gfd/psi)	0.15

Table 4-10: Module Performance after Cleaning

Parameter	Feed	Concentrate	Permeate
pH	7.32	7.33	5.56
Turbidity (NTU)	0.35	0.27	0.09

The cleaning process was considered successful, as the performance of the unit after cleaning was very similar to the unit’s performance early in the test when any build up of materials that might foul the membrane could not affect the unit. It was not possible to completely test the effectiveness of the cleaning process, as the unit did not actually require cleaning after more than 30 days of operation. The cleaning process did demonstrate that the procedure outlined for cleaning this unit did perform properly and no damage or deterioration to the membrane unit occurred do to the cleaning process.

4.3.3 Task 3: Finished Water Quality

Water Quality Data Presentation

This section presents the membrane module rejection characteristics for various arsenic species and for antimony. The daily results for arsenic and antimony are presented in tabular and graphical format along with summarized versions of the data. Other parameters, such as TDS, conductivity, pH, fluoride, iron, manganese, sulfate, which provide general information on water quality and can have an impact on membrane module performance, are presented in a summarized format. All of the raw water quality data collected during the test period are provided in Appendix G. The possible effects of iron fouling

are also discussed in this section, including a mass balance calculation. Feedwater temperature data were taken from the calibrated in-line thermometer twice a day, and the temperature remained unchanged (49°F; 9.44°C) throughout the test.

Overview of Arsenic Removal

The primary goal of this performance verification study was to evaluate the ability of the Hydranautics ESPA2-4040 Reverse Osmosis Membrane Element Module to remove arsenic from the Park City Spiro Tunnel Bulkhead water supply. The industry standard approach for evaluating a reverse osmosis system's capability to remove a specific contaminant is to calculate the percent rejection characteristics of the membrane module. The percent rejection characteristic is a measure of the ability of the membrane module to remove or reject a particular contaminant, as defined under the term "Percent Solute Rejection" in the Operational Formulae section. The Tables and Figures presented in the following subsections illustrate the removal characteristic of various species of arsenic by the Hydranautics membrane module operating on this feedwater source.

The results clearly show that the Hydranautics unit, operating under the defined conditions in this test, consistently achieved better than 98% removal of total arsenic from the Spiro Tunnel feed water. The permeate from the unit consistently showed total arsenic levels below 0.5 µg/l, which is the method detection limit (MDL) reported by the laboratory for total arsenic. Only two permeate results out of 34 showed positive results above the MDL (0.52 µg/l; 71 µg/l). The elevated result of 71 µg/l is believed to be caused by mislabeled sample bottles.

While the primary goal of the verification test was to determine the total arsenic removal, the verification test also emphasized the collection of data for dissolved arsenic, arsenic (III) and arsenic (V) present in the feed water. RO membrane technology is normally utilized to remove contaminants that are dissolved in water as opposed to being used as a filtration device for particulate material. While RO membranes can effectively remove particulate from a water stream, particulate matter is actually a potential problem to membrane systems of this type. The particulate can foul the membrane, which will cause frequent cleaning cycles and high maintenance cost. The removal of particulate contaminants is generally better achieved using other filtration technology. In fact it is typically recommended that a filter of some type be placed in front of the RO membrane system to remove particulates prior to treatment by the membrane module. In the test system a 5 µ cartridge filter was used ahead of the membrane module. The cartridge filter was changed every two days at the beginning of the test and daily beginning on April 2 for the remaining 16 days of the 34-day test period.

The cartridge filters may have removed some portion of the insoluble arsenic present in the water during periods of high turbidity. Elevated turbidity was measured on two occasions and one of the events partially plugged the cartridge filters. However, the actual amount of arsenic that may have been removed by the prefilter appears to be small to negligible. The feedwater total arsenic measured during the verification period averaged 65µg/L, while the average total arsenic in the raw water measured over the period 1980-1999 was 66 µg/L. Also, on one occasion (March 20), turbidity was monitored before and after the prefilter, with the raw water showing a turbidity of 1.00 to 1.23 NTU and the feedwater after the prefilter was measured as 1.44 NTU. While data was not routinely collected before and after the prefilter, this information would indicate that the prefilter only removed material during high

level spikes of suspended solids. On typical operating days the prefilter would not appear to have had a significant impact on the feedwater water quality concentrations.

In order to provide additional information and more specific information on the capability of the Hydranautics unit to remove soluble arsenic species, dissolved arsenic and the two predominate valence states of arsenic (III and V) were monitored throughout the test period. The results for dissolved arsenic show that the average removal met the 98% goal, with a minimum removal of 97.1% based on the actual data reported by the laboratory. The data for dissolved arsenic in the permeate may, however, be biased slightly high do to interferences from the sample preservation procedure. This could cause an understatement of the actual percent rejection. In order to monitor for the various arsenic species, sulfuric acid is used to preserve the samples. The use of the sulfuric acid is suspected to have interfered with the accuracy of the dissolved arsenic results at low concentration levels in the permeate. This issue is discussed further in the subsection presenting the dissolved arsenic results and in detail in Appendix I.

NSF performed a quality control review of the arsenic analyses. The report suggested that a higher quantitation limit might be more appropriate for these results. The QC review stated that the quantitation limit of 0.5 $\mu\text{g/l}$ used by the laboratory may be too low and recommended a quantitation limit of 3-5 $\mu\text{g/l}$, which would eliminate the discrepancy between the total and dissolved arsenic data. Reporting the data at a higher quantitation limit would impact the rejection percentage calculation, lowering the calculated percent rejection. Additional information on the QA report is discussed in the QA section 4.5.10.

All of the data are presented exactly as reported by the State of Utah laboratory. The laboratory has indicated that the precision and accuracy of their test methods support reporting two or three significant figures for the analytical data. They also concur that it is inappropriate to report data as quantitative down to the minimum detection limit for arsenic measurement by ICP-MS, which is in the range of 0.1 to 0.2 $\mu\text{g/l}$. Results below 0.5 $\mu\text{g/l}$ are considered only qualitative and not quantitative. Based on this information, all arsenic data are reported to a method detection limit (MDL) of 0.5 $\mu\text{g/l}$. Results below this limit are reported as <0.5 $\mu\text{g/l}$.

Total Arsenic

Tables 4-11 and 4-12, and the Figure 4-3 present the daily and summarized results for total arsenic analysis on the feed water, the concentrate and the permeate for the entire test period. The percent rejection is calculated using the standard operational formula, which is equivalent to calculating the percent removal of the contaminant. A value of 0.5 $\mu\text{g/l}$ was used in the calculation for the permeate concentration whenever the reported concentration was below the MDL (0.5 $\mu\text{g/l}$). Thus, the reported percent rejection is most likely a conservative value as the actual total arsenic present in the permeate is undoubtedly less than the 0.5 $\mu\text{g/l}$ value used in the calculation. The data shows conclusively that the Hydranautics unit removed better than 99% of the total arsenic, yielding finished water (permeate) that contained arsenic at or below the reporting limit of 0.5 $\mu\text{g/l}$. The feedwater total arsenic concentrations, measured during the test period, were very similar to the levels recorded historically (Table 1-1). Total arsenic concentrations ranged from 49.3 to 114 $\mu\text{g/l}$ with an average value of 65 $\mu\text{g/l}$. The total arsenic

levels were mostly grouped within a narrow range as shown by the 95% confidence interval of 61 to 69 $\mu\text{g/l}$. Permeate concentrations were also very consistent with all but two values being below the MDL of 5 $\mu\text{g/l}$. The data indicate that the Hydranautics unit was able to produce a consistent high quality permeate stream within the range of feedwater concentrations encountered during the test period.

One permeate result on March 27 was reported at 71 $\mu\text{g/l}$, which was similar to the feedwater levels on that day. The total arsenic concentrate level was reported as $<0.5 \mu\text{g/l}$. It is quite apparent from inspection of the overall results that the concentrate and permeate samples were somehow reversed on this day. The results for this one day were not used in developing the summary statistics reported in Table 4-12.

Inspection of the total arsenic data for the concentrate shows that there is some type of anomaly with the total arsenic results. Given the high degree of rejection of arsenic by the unit, it would typically be expected that the concentrate stream would have a higher concentration of arsenic than the feed water stream. The expected process with this membrane technology is that the membrane rejects the solute, while clean water passes through as permeate. This process results in the solute being concentrated in the concentrate stream. For some reason the data reported for this test show that the arsenic is effectively rejected by the membrane but is not being accurately measured in the concentrate stream. There will be more discussion of this issue in the section that shows the mass balances for arsenic and other constituents. Despite this possible anomaly in the data, the permeate results for total arsenic and the individual species show that the membrane unit very effectively rejected or removed the arsenic from the feed water.

Table 4-11: Total Arsenic Readings

Total Arsenic Readings (µg/L)				
Date	Feed	Concentrate	Permeate ¹	% Rejection ²
3/15/00	66	73	<0.5	99
3/16/00	64	68	<0.5	99
3/17/00	68	72	<0.5	99
3/18/00	72	79	<0.5	99
3/19/00	83.36	99	<0.5	99.4
3/20/00	67	70	<0.5	99
3/21/00	59	53	<0.5	99
3/22/00	56	60	0.52	99
3/23/00	60	65	<0.5	99
3/24/00	66	63	<0.5	99
3/25/00	59	61.5	<0.5	99
3/26/00	61	58.4	<0.5	99
3/27/00 ³	70	<0.5	71	--
3/28/00	114	59.7	<0.5	99.6
3/29/00	77.9	68.2	<0.5	99.4
3/30/00	54.8	60.9	<0.5	99.1
3/31/00	60.4	66.3	<0.5	99.2
4/1/00	63.2	66.8	<0.5	99.2
4/2/00	68.1	51.3	<0.5	99.3
4/3/00	49.3	44.2	<0.5	99.0
4/4/00	58.5	53.1	<0.5	99.1
4/5/00	77.5	52.9	<0.5	99.4
4/6/00	81	68.9	<0.5	99
4/7/00	57.2	58.9	<0.5	99.1
4/8/00	61.2	62.3	<0.5	99.2
4/9/00	64.2	61.2	<0.5	99.2
4/10/00	50.4	51.2	<0.5	99.0
4/11/00	83.2	89.6	<0.5	99.4
4/12/00	57.2	58.6	<0.5	99.1
4/13/00	61.1	60.4	<0.5	99.2
4/14/00	52.7	50.2	<0.5	99.1
4/15/00	49.9	50.4	<0.5	99.0
4/16/00	61.3	52.7	<0.5	99.2
4/17/00	59	52	<0.5	99

(1) The reliability of the low-level data (MDL of 0.1 µg/L to approximately 2µg/L) should be considered as only qualitative (not quantitative).

(2) The MDL value (0.5 µg/L) was used as the permeate reading (except where indicated) for % rejection calculations.

(3) Indicates likely mislabeled sample containers of concentrate and/or permeate

Table 4-12: Total Arsenic Data Summary

	Feed (µg/L)	Concentrate (µg/L)	Permeate (µg/L)	% Rejection
Average	65	62	0.5	99
Minimum	49.3	44.2	<0.5	99.0
Maximum	114	99	0.52	99.6
Standard Deviation	12	11	0.0	0.0035
Confidence Interval	(61, 69)	(59, 66)	(0.5, 0.5)	(99, 99)

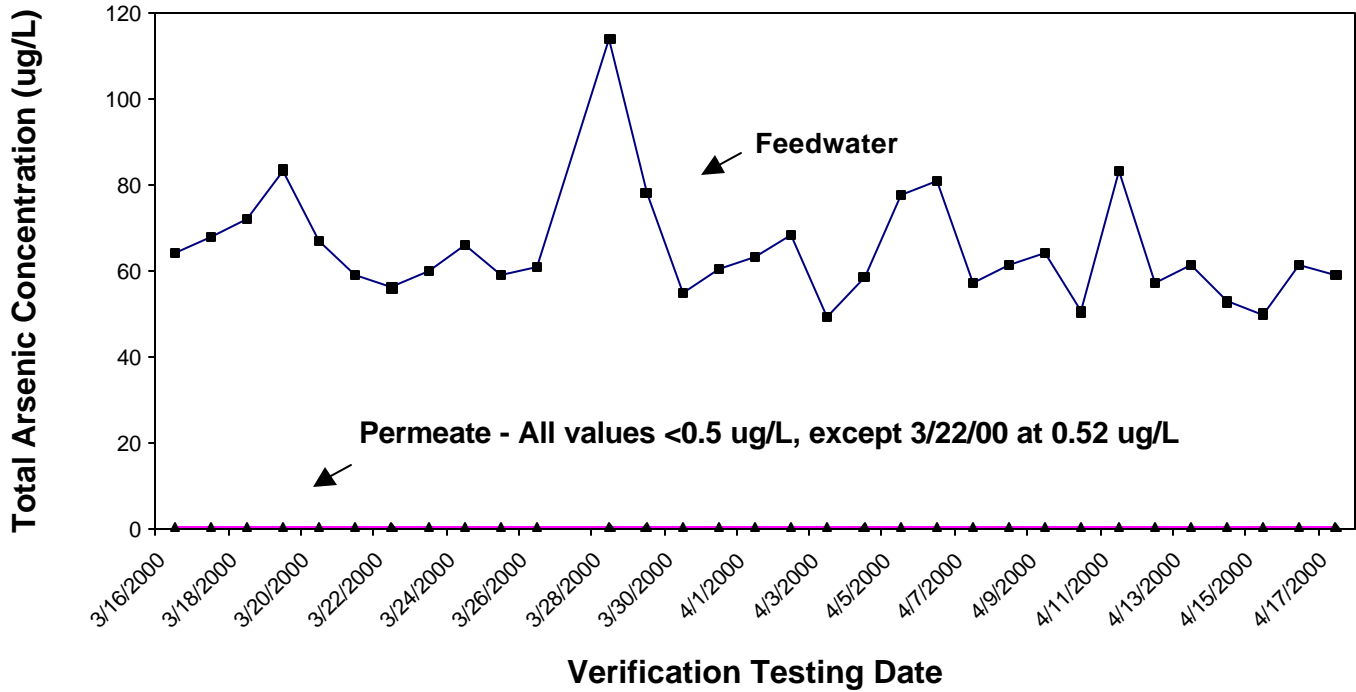

Figure 4-3: Total Arsenic Concentration vs. Time
 (Data from likely mislabeled containers are not included in this figure)

Dissolved Arsenic

While the overall goal of the verification test was to test the claim that the Hydranautics unit could consistently achieve 98% rejection of total arsenic from a feedwater, another important test and possibly an even more important test for Reverse Osmosis units, is to measure the capability to reject a contaminant dissolved in a feed water. Section 2.2 described the basic principles for various pressure membrane technologies. Reverse osmosis technology is the cross flow filtration process that produces the highest quality permeate of any of the membrane technologies. RO membranes will typically have the smallest pore sizes and the lowest molecular weight cut-off ranges resulting in the ability of the membrane to reject a large portion of the dissolved salts present in feed water. While RO units will also reject or capture suspended solids or colloidal matter, other pressure technologies, such as

microfiltration or ultrafiltration, can reject or remove particulate matter at lower operating pressures and cost. In fact if the contaminants to be removed are primarily in particulate form and the particulate levels are high in the feed water, RO units can be problematic to operate due to fouling of the membranes. RO units are generally best suited for and give the best performance for constituents that are in the dissolved salt form. It would be expected that the overall best system performance would be achieved for this membrane technology for feed waters containing a high percentage of dissolved arsenic.

The dissolved arsenic and other dissolved solids will also have an impact on the operating conditions of an RO membrane module such as the Hydranautics units. As discussed in Section 2.3 the concentration of dissolved salts has a direct impact on the osmotic pressure of the system and the potential for fouling due to soluble salts forming precipitates on the membrane surface or in the membrane pores. The data obtained before this test started and collected during the test period show that the levels of dissolved arsenic and total dissolved solids are low enough that even with a wide variation, the concentrations should have little impact on the actual pumping pressures required to generate a reasonable permeate flow rate. The data collected for dissolved arsenic during the test showed that the dissolved arsenic averaged 42 $\mu\text{g/l}$ and represented 65% of the total arsenic present in the feed water.

Tables 4-13 and 4-14, and Figure 4-4 show the dissolved arsenic data for the feed water, concentrate, and permeate collected during the test period. The percent rejection of dissolved arsenic of the Hydranautics ESPA2-4040 Reverse Osmosis Membrane Element Module is shown as calculated using the standard operational formula for solute rejection. These data show that the membrane module was very effective in rejecting dissolved arsenic and producing a permeate with low levels of dissolved arsenic. The average rejection or removal of dissolved arsenic was 98% with a minimum of 97.1% and a maximum of 99%. There was one anomalous data point for the permeate and the concentrate water on March 27. The permeate value of 51 $\mu\text{g/l}$ and concentrate level of 0.85 $\mu\text{g/l}$ appear to be reversed. It is most likely that the sample bottle for this day were inadvertently mislabeled. These data were not used in developing the summary statistics in Table 4-14.

A closer inspection of the dissolved arsenic data for the permeate show that there is an inconsistency between the dissolved arsenic results and the total arsenic results shown for the permeate in Table 4-11. The total arsenic results are all lower than the dissolved arsenic concentrations. This obviously cannot be an accurate result. Additional comparisons with arsenic speciation data shown later in this section (Tables 4-15 and 4-17) show a similar inconsistency. The dissolved fraction of the arsenic is reported at higher concentrations than the two dissolved arsenic species (III and V). While it is possible that some other form of dissolved arsenic could be present, that is considered highly unlikely in normal oxygenated feed waters. The feedwater and concentrate data show in all cases that the total arsenic is higher than the dissolved arsenic. The concentration in these streams is much higher suggesting that the problem only occurs at concentrations near the detection limit. These data would suggest that the problem is related to interference in the analysis at very low concentrations.

Given this inconsistency, the State of Utah laboratory was asked to review the data and attempt to explain the possible cause of the discrepancy. Their findings are presented in their entirety in Appendix I. The basic cause of the problem, in their opinion, appears to be that the use of sulfuric acid in the preservation process for the dissolved arsenic samples causes a positive interference in the ICP-MS analysis. This positive interference is relatively small (a few tenths of a $\mu\text{g/l}$; typically 0.4-0.6 $\mu\text{g/l}$), but at

the low concentrations being measured in the permeate, this positive interference is significant. Therefore, the dissolved arsenic results appear to be biased high. This positive bias results in an understating of the rejection percentage for the dissolved arsenic in the feed water.

The NSF quality control review of the data suggested that a higher quantitation limit might be more appropriate for the arsenic analysis. A higher reporting limit of 3 µg/l would eliminate the reporting discrepancy, but the rejection percentage calculation using the 3 µg/l value would yield results in the 90.7-94.2%.

Review of the dissolved arsenic results shown in Tables 4-13 and 4-14 shows that the Hydranautics unit performed well in rejecting dissolved arsenic in this feed water. The data as reported by laboratory show an average rejection of 98%. Further, if the permeate results showing total arsenic as less than 0.5 µg/l are used to assume that the true values for dissolved arsenic are also below 0.5 µg/l (eliminating the positive bias in the analytical data), it can be seen that the membrane module produced a high quality permeate with a rejection of dissolved arsenic to a concentration in the permeate of less than 0.5 µg/l or better than 98% removal on all days.

Table 4-13: Dissolved Arsenic Data

Date	Feed (µg/L)	Concentrate (µg/L)	Permeate ¹ (µg/L)	% Rejection	Date	Feed (µg/L)	Concentrate (µg/L)	Permeate (µg/L)	% Rejection
3/15/00	49	61	<0.5	99	4/2/00	32.2	34.7	0.6	98.1
3/16/00	46	53	0.69	99	4/3/00	34.8	37.6	0.7	98.0
3/17/00	52	58	0.89	98	4/4/00	34.5	39.3	1	97.1
3/18/00	52	57	0.77	99	4/5/00	33.5	37.7	0.9	97.3
3/19/00	50	57	0.9	98	4/6/00	33.3	36.7	0.64	98.1
3/20/00	48	52	0.93	98	4/7/00	39.6	43.7	0.8	98.0
3/21/00	47	52	1	98	4/8/00	37.4	43.3	0.9	97.6
3/22/00	45	52	1	98	4/9/00	38.9	43.1	0.9	97.7
3/23/00	45	50	1	98	4/10/00	39.2	42.9	0.9	97.7
3/24/00	43	49	0.76	98	4/11/00	38.9	21.9	0.8	97.9
3/25/00	43	52	0.7	98	4/12/00	38.8	43.2	0.7	98.2
3/26/00	47	53	0.74	98	4/13/00	37.7	43.3	1	97.3
3/27/00 ²	45	0.85	51	NA	4/14/00	35.4	38.2	1	97.2
3/28/00	45.5	52.3	1	97.8	4/15/00	38.5	41.4	0.7	98.2
3/29/00	45.7	51.4	0.8	98.2	4/16/00	39	42.9	1	97
3/30/00	47.2	52	1	97.9	4/17/00	40.8	43.6	0.8	98.0
3/31/00	41.6	53.5	1	97.6					
4/1/00	48.2	54	1	97.9					

- 1) The reliability of the low-level data (MDL of 0.1 µg/L to approximately 2 µg/L) should be considered as only qualitative (not quantitative).
- 2) Indicates likely mislabeled containers of concentrate and/or permeate.

Table 4-14: Dissolved Arsenic Data Summary

	Feed($\mu\text{g/L}$)	Concentrate($\mu\text{g/L}$)	Permeate($\mu\text{g/L}$)	% Rejection
Average	42	47	0.8	98
Minimum	32.2	21.9	<0.5	97.1
Maximum	52	61	1	99
Standard Deviation	5.6	8.3	0.1	0.41
Confidence Interval	(40, 44)	(44, 50)	(0.8, 0.9)	(98, 98)

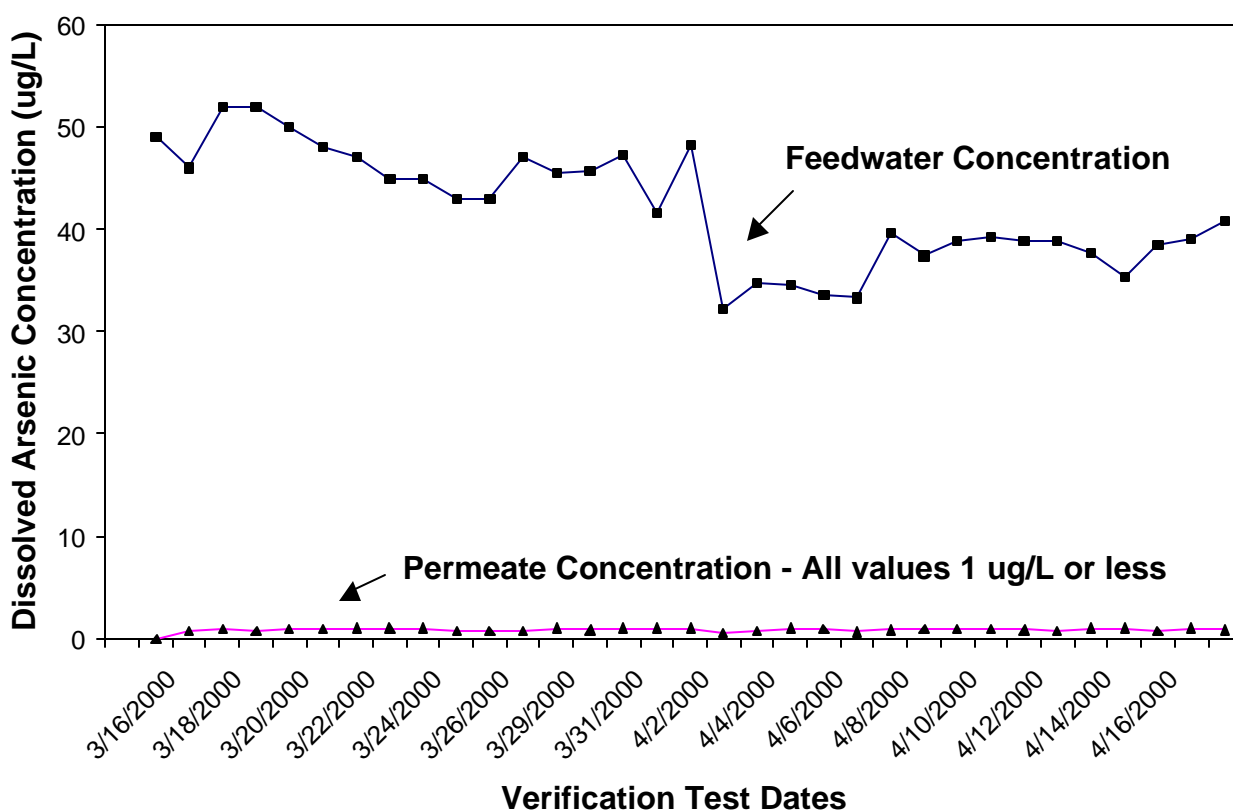

Figure 4-4: Dissolved Arsenic Concentration vs. Time
 (Data from likely mislabeled containers are not included in this figure)

Arsenic (III)

In addition to collecting samples for total and dissolved arsenic, samples were also collected for the speciation of arsenic present in the feedwater, concentrate, and permeate. As described in Section 1.4, arsenic in natural waters is predominately present as either arsenic (III) or arsenic (V). Arsenic (V) is generally considered to be the dominant species in oxygenated waters. Arsenic (III) can be present in

both ionic and nonionic form. There is some indication that arsenic (III) may not be rejected as easily as Arsenic (V). This may be due to the valence state or the ionic form of arsenic (III). It may also be dependent on the membrane material. For these reasons it was determined that speciation of the arsenic should be part of the test program to provide data on the individual species of arsenic, in addition to arsenic data for the total and dissolved fractions. If it was found that a particular arsenic species was not rejected as efficiently, this would be important in applying the process to different feed waters around the country.

Tables 4-15 and 4-16, and Figure 4-5 present the As (III) removal characteristics of the Hydranautics ESPA2-4040 Reverse Osmosis Membrane Element Module. The percent rejection was calculated using the formula as shown in the operational formulae. A value of 0.5 $\mu\text{g/l}$ was used in the calculation for the permeate concentration whenever the reported concentration was below the MDL (0.5 $\mu\text{g/l}$). Thus, the reported percent rejection is most likely a conservative value as the actual arsenic (III) present in the permeate was undoubtedly less than the 0.5 $\mu\text{g/l}$ value used in the calculation.

The data show that the membrane module was very effective in rejecting arsenic (III) present in the feed water. Arsenic (III) represents 17% of the dissolved arsenic present in the feedwater. Table 4-19 shows the percentages of dissolved arsenic species in the feed water and concentrate. All of the permeate concentrations are below the MDL of 0.5 $\mu\text{g/l}$, except for one value at 0.64 $\mu\text{g/l}$ and two data sets (March 27 and April 1) where the samples appear to have been mislabeled. In fact, the results for Arsenic (III) are very similar to those for Arsenic (V) reported later. These data show that the Hydranautics unit handled the arsenic (III) contaminants in this feed water with efficiency similar to the rejection of arsenic (V) and total arsenic. Further, the pH of the water was consistently in the 7.2-7.5 range, which would indicate the arsenic (III) present in the water was nonionic in form. All of the arsenic (III) results suggest that the Hydranautics unit performance for rejection of arsenic is not impacted by the presence of arsenic (III) versus other species and forms of arsenic in the feed water.

Reviewing the arsenic (III) rejection percentages shows that the rejection ranged from 71 to 98% with an average rejection of 84%. These results appear low when compared to earlier reported rejection efficiencies of 98% or greater. The actual permeate concentrations were very low with most below the detection limit of 0.5 $\mu\text{g/l}$. The results of rejection calculations show the impact detection limits can have on calculated rejection or removal percentages. The actual arsenic (III) concentration in the feed water is low, averaging 7 $\mu\text{g/l}$ and varying from 1.8 to 20 $\mu\text{g/l}$. When the rejection calculation is made, it is assumed that the permeate level is at the detection limit as the true value is uncertain. Thus, when the feed water is at a lower raw water level (i.e. 1.8 $\mu\text{g/l}$) using the 0.5 $\mu\text{g/l}$ MDL gives a rejection of 72%. When the feedwater is at a higher level of 20 $\mu\text{g/l}$, the same MDL gives a rejection of 98%. Because of the low level of arsenic (III) in the feed water and the MDL of 0.5 $\mu\text{g/l}$ the actual percent rejection understates the excellent performance of the unit in rejecting arsenic (III) in this feed water.

Table 4-15: Arsenic (III) Data

Date	Feed (µg/L)	Concentrate (µg/L)	Permeate (µg/L)	% Rejection	Date	Feed (µg/L)	Concentrate (µg/L)	Permeate ¹ (µg/L)	% Rejection ²
3/15/00	NS	NS	NS	-	4/2/00	10.4	5.3	<0.5	95
3/16/00	NS	NS	NS	-	4/3/00	9	13.8	<0.5	94
3/17/00	2	2.2	<0.5	75	4/4/00	14.1	8.1	<0.5	96
3/18/00	1.8	3.1	<0.5	72	4/5/00	2.7	2.9	<0.5	81
3/19/00	NS	NS	NS	-	4/6/00	2.8	2.8	<0.5	82
3/20/00	2.1	2.4	<0.5	76	4/7/00	2.4	2.4	<0.5	79
3/21/00	2.2	2.5	0.64	71	4/8/00	2.2	2.2	<0.5	77
3/22/00	2.1	2.3	<0.5	76	4/9/00	2.6	2.7	<0.5	81
3/23/00	20	25	<0.5	98	4/10/00	2.9	2.6	<0.5	83
3/24/00	8.3	6.3	<0.5	94	4/11/00	2.7	2.7	<0.5	81
3/25/00	8.7	11	<0.5	94	4/12/00	2.5	2.4	<0.5	80
3/26/00	19	18	<0.5	97	4/13/00	2.4	2.3	<0.5	79
3/27/00 ³	13	<0.5	8.6	NA	4/14/00	2.5	2.3	<0.5	80
3/28/00	17.3	8.9	0.5	97	4/15/00	2.3	2.2	<0.5	78
3/29/00	2.2	2.1	<0.5	77	4/16/00	2.3	0.8	<0.5	78
3/30/00	16.9	26	<0.5	97	4/17/00	2.3	2.1	<0.5	78
3/31/00	12	12	<0.5	96					
4/1/00 ³	10.5	6.4	10.5	NA					

- 1) The reliability of the low-level data (MDL of 0.1 µg/L to approximately 2µg/L) should be considered as only qualitative (not quantitative).
- 2) The MDL value (0.5 µg/L) was used as the permeate reading (except where indicated) for % rejection calculations.
- 3) Indicates likely mislabeled sample containers of concentrate and/or permeate.
- 4) NS – No sample

Table 4-16: Arsenic (III) Data Summary

	Feed (µg/L)	Concentrate (µg/L)	Permeate (µg/L)	% Rejection
Average	7	6.2	0.5	84
Minimum	1.8	0.8	0.5	71
Maximum	20	26	0.64	98
Standard Deviation	6	6.8	0.03	9.0
Confidence Interval	(4, 9)	(3.8, 8.5)	(0.5, 0.5)	(81, 88)

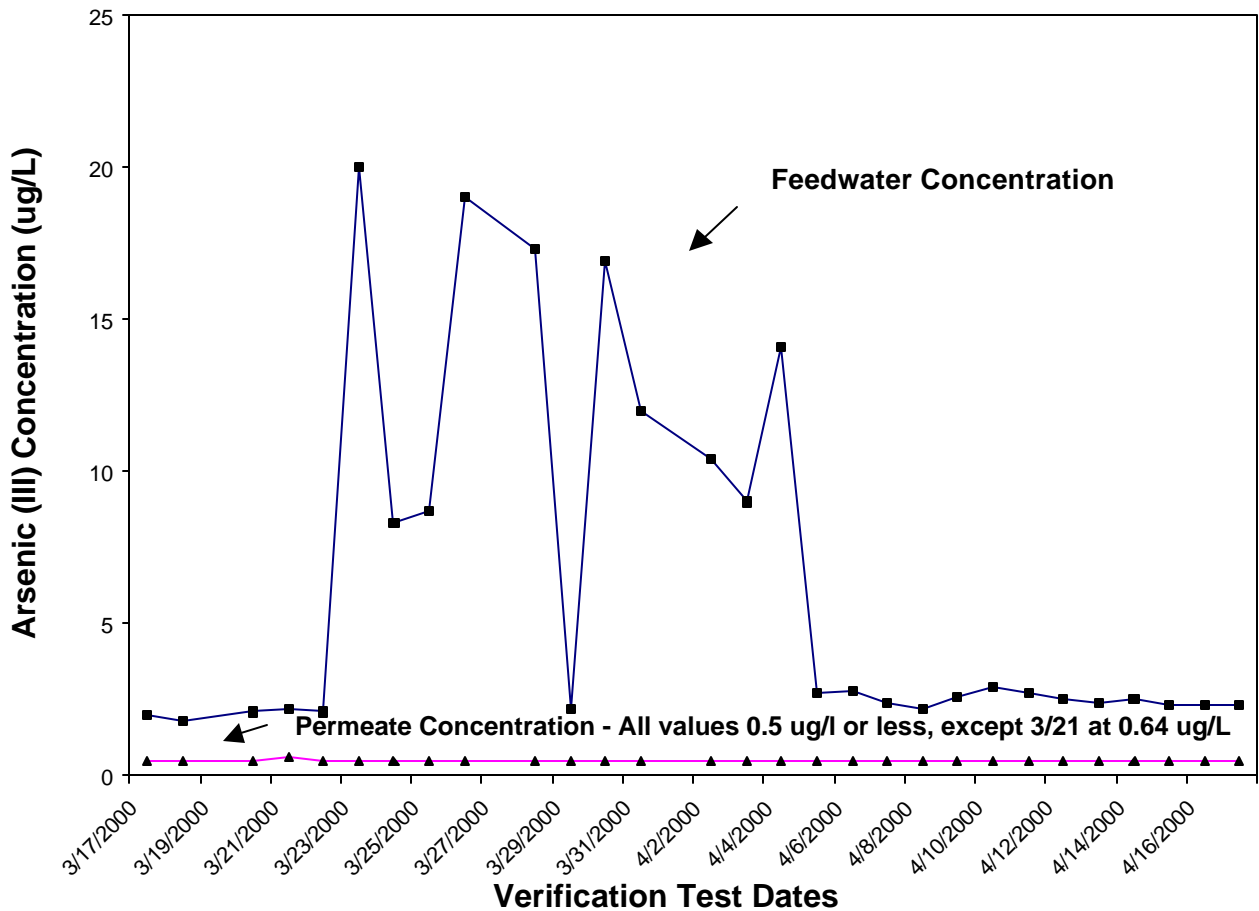

Figure 4-5: Arsenic (III) Concentration Data vs. Time
 (Data from likely mislabeled containers are not included in this figure)

Arsenic (V)

Arsenic (V) is normally the predominate species of dissolved arsenic found in natural oxygenated waters. Therefore, the ability of an RO membrane module to reject arsenic and produce a high quality permeate is dependent on the ability of the membrane to reject arsenic (V) species. Most RO membranes are expected to reject multivalent ions more readily than monovalent ions and it would be expected that arsenic (V) species should have a high level of rejection. However, it was important for this verification test to measure and prove that the Hydranautics unit could achieve a high level of control.

Tables 4-17 and 4-18, and Figure 4-6 show the arsenic (V) results for the entire test period. Daily results for the feed water, concentrate, and permeate are presented in Table 4-17 and summary statistics are given in Table 4-18. The percent rejection for the Hydranautics ESPA2-4040 Reverse Osmosis Membrane Element Module is calculated using the formula as shown in the operational

formulae. A value of 0.5 µg/l is used in the calculation for the permeate concentration whenever the reported concentration was below the MDL (0.5 µg/l), which is the result in 27 of the 31 samples analyzed. Thus, the reported percent rejection is most likely a conservative value as the actual arsenic (V) present in the permeate is undoubtedly less than the 0.5 µg/l value used in the calculation.

The arsenic (V) results show that this species of arsenic represented 83% of the dissolved arsenic present in the feed water (see Table 4-19). The feedwater concentration averaged 35 µg/l with a range of 20.4 to 50.2 µg/l. The Hydranautics membrane module handled the arsenic (V) very effectively with an average rejection percentage of 99%. The permeate contained less than 0.5 µg/l (MDL) for 27 samples and three samples tested at the 0.5 µg/l level. There was one sample for March 27 reported at a value of 42.4 µg/l but the concentrate for that day is reported at <0.5 µg/l. The sample bottles were apparently mislabeled on this day.

The performance of the RO unit for removing arsenic (V) was as good or better than for any other arsenic species. The arsenic (V) measured in the test procedure is dissolved arsenic (V) so the results also show the ability of the RO unit to handle dissolved arsenic species. The ability of the RO unit to reject soluble species of arsenic at a high level demonstrates that the performance of this unit is excellent.

Table 4-17: Arsenic (V) Data

Date	Feed (µg/L)	Concentrate (µg/L)	Permeate (µg/L)	% Rejection	Date	Feed (µg/L)	Concentrate (µg/L)	Permeate ¹ (µg/L)	% Rejection ²
3/15/00	NS	NS	NS	-	4/2/00	21.8	29.4	<0.5	97.7
3/16/00	NS	NS	NS	-	4/3/00	25.8	23.8	<0.5	98.1
3/17/00	50	55.8	<0.5	99	4/4/00	20.4	31.2	<0.5	97.5
3/18/00	50.2	53.9	<0.5	99.0	4/5/00	30.8	34.8	<0.5	98.4
3/19/00	NS	NS	NS	-	4/6/00	30.5	33.9	<0.5	98.4
3/20/00	45.9	49.6	<0.5	98.9	4/7/00	37.2	41.3	<0.5	98.7
3/21/00	44.8	49.5	<0.5	98.9	4/8/00	35.2	41.1	<0.5	98.6
3/22/00	42.9	49.7	<0.5	98.8	4/9/00	36.3	40.4	<0.5	98.6
3/23/00	25	25	<0.5	98	4/10/00	36.3	40.3	<0.5	98.6
3/24/00	34.7	42.7	<0.5	98.6	4/11/00	36.2	19.2	<0.5	98.6
3/25/00	34.3	41	<0.5	98.5	4/12/00	36.3	40.8	<0.5	98.6
3/26/00	28	35	<0.5	98	4/13/00	35.3	41	0.5	98.6
3/27/00 ³	32	<0.5	42.4	NA	4/14/00	32.9	35.9	0.5	98.5
3/28/00	28.2	43.4	<0.5	98.2	4/15/00	36.2	39.2	<0.5	98.6
3/29/00	43.5	49.3	<0.5	98.9	4/16/00	36.7	41.7	0.5	98.6
3/30/00	30.3	26	<0.5	98.3	4/17/00	38.5	41.5	<0.5	98.7
3/31/00	29.6	41.5	<0.5	98.3					
4/1/00	37.7	47.6	<0.5	98.7					

- 1) The reliability of the low-level data (MDL of 0.1 µg/L to approximately 2µg/L) should be considered as only qualitative (not quantitative).
- 2) The MDL value (0.5 µg/L) was used as the permeate reading (except where indicated) for % rejection calculations.
- 3) Indicates likely mislabeled sample containers of concentrate and/or permeate.
- 4) NS – No Sample

Table 4-18: Arsenic (V) Data Summary

	Feed (µg/L)	Concentrate (µg/L)	Permeate (µg/L)	% Rejection
Average	35	40	0.5	99
Minimum	20.4	19.2	<0.5	97.6
Maximum	50.2	55.8	0.5	99.0
Standard Deviation	7.3	8.9	0.0	0.35
Confidence Interval	(32, 38)	(36, 43)	(0.5, 0.5)	(98, 99)

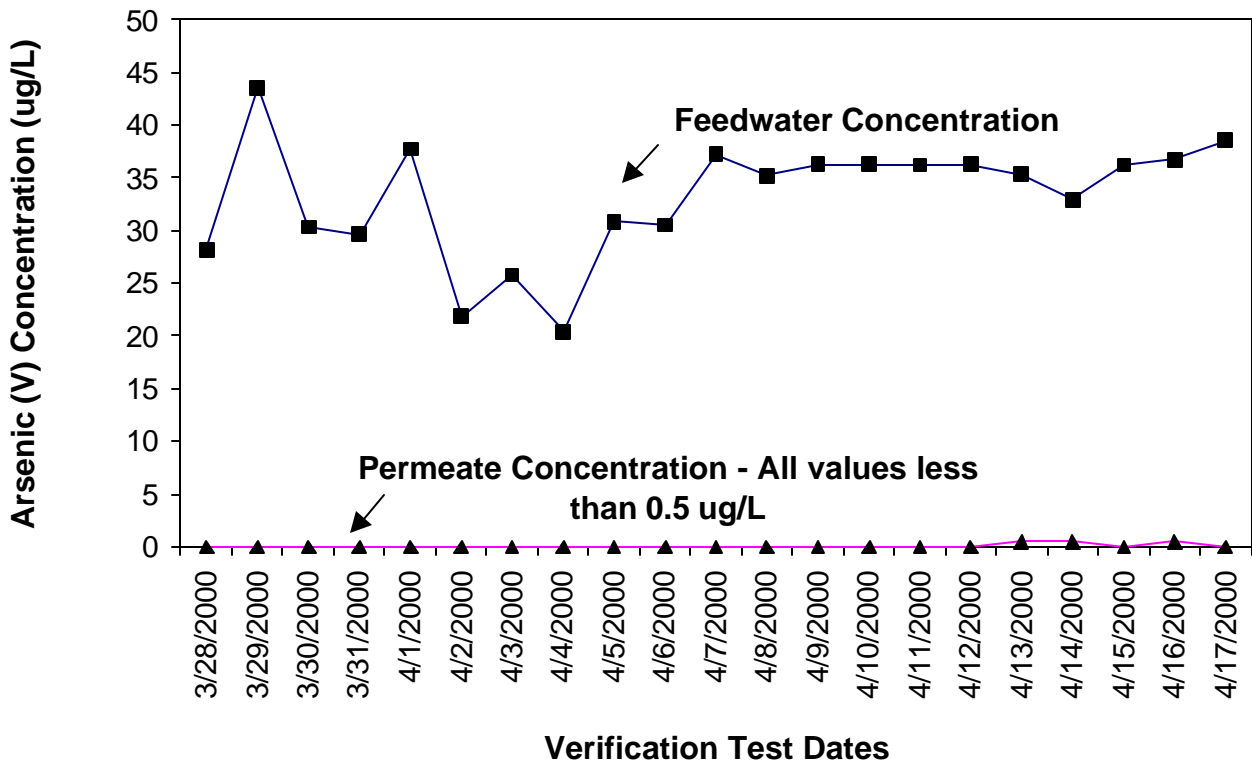

Figure 4-6: Arsenic (V) Concentration Data vs. Time
 (Data from likely mislabeled containers are not included in this figure.)

Arsenic Speciation Summary

As described in the preceding sections, the data collection tasks for this verification project included the determination of total and dissolved arsenic, and speciation of the arsenic between valence state 3 and 5. All of the daily and summary data have been presented in the previous tables in this section. Table 4-

19 summarizes these results and shows the percentages of the various fractions of arsenic that were present in the feed water, concentrate, and permeate.

The data indicate that 65% of the arsenic in the feedwater was dissolved and 76% of the arsenic in the concentrate was in the dissolved form. Arsenic (V) represented 83% of the dissolved arsenic in the feed water and 85% of the dissolved arsenic in the concentrate. Most of the permeate data is below the MDL and, therefore, percentages of the various species are not meaningful.

This final summary of the data by species shows that the membrane module operated at a high rejection percentage and generated permeate with a low concentration of all arsenic species.

Table 4-19: Percentage of Various Arsenic Species Based on Summary Average Values

	Feed (µg/L)	Percent of Total As	Percent of Dissolved As	Concentrate (µg/L)	Percent of Total As	Percent of Dissolved As	Permeate (µg/L)
Total As	65	NA	NA	62	NA	NA	0.5
Dissolved As	42	65%	NA	47	76%	NA	0.8
As(III)	7	N/A	17%	6.2	N/A	13%	0.5
As(V)	35	N/A	83%	40	N/A	85%	0.5

Note: Percentages do not total 100% because data are averages.
NA = Not applicable

Total Arsenic Mass Balance

As discussed in the section on total arsenic, there was a potential anomaly in the data when the feed water concentrations were compared to the concentrate and permeate concentrations. In order to examine possible retention of arsenic within the module, summaries of the mass balances for total and dissolved arsenic, using measured flow rates and laboratory analytical data are listed in Table 4-20 below. The daily calculations used to develop these summaries are presented in tables in Appendix G. The formula used to calculate the mass balance is as follows:

$$Q_F C_F = Q_C C_C + Q_P C_P$$

where:

- Q_F = Feed Flow Rate (l/day) C_F = Feedwater Concentration (mg/l)
- Q_C = Concentrate Flow Rate (l/day) C_C = Concentrate Concentration (mg/l)
- Q_P = Permeate Flow Rate (l/day) C_P = Permeate Concentration (mg/l)

The actual daily mass of arsenic in the feed water, concentrate, and permeate was calculated by converting the flow rate in gallons per minute to liter per day (3.785 l/gal; 60 min/hr; 24 hrs/day). The mass in micrograms was converted to milligrams by dividing by 1000. If all of the arsenic present in the feedwater exited the membrane module, then the sum of the mass in the concentrate and permeate waters should be equal to the mass of arsenic in the feedwater. The difference or possible retention of

arsenic in the system was calculated by subtracting the arsenic measured in the concentrate and permeate waters from the feedwater. Permeate mass calculations assumed that arsenic was present at 0.5 µg/l for all values reported as <0.5 µg/l (MDL).

The mass balances show that on all but one day (March 19) the total arsenic entering the system was higher than the mass of total arsenic exiting the system. Mass balances show that the same was true for dissolved arsenic on all but two days of operation (March 25 and 31). Over the thirty-four day test period the amount of total arsenic unaccounted for in the mass balance is 10,995 mg, which represents approximately 17% of the total arsenic in the feed water. In the case of dissolved arsenic, the unaccounted for quantity in the mass balance is 1,929 mg, which represents approximately 5% of the dissolved arsenic in the feed water.

Table 4-20: Summary of Total and Dissolved Arsenic Mass Balances

TOTAL ARSENIC			
Total Mass Feed (mg)	Total Mass Concentrate (mg)	Total Mass Permeate (mg)	Mass Difference (mg)
62,112	51,048	69.4	10,995

DISSOLVED ARSENIC			
Total Mass Feed (mg)	Total Mass Concentrate (mg)	Total Mass Permeate (mg)	Mass Difference (mg)
40,181	38,134	117.7	1929

The unaccounted arsenic in the mass balances may be a result of several factors, including sample collection method, laboratory variation, and retention of arsenic within the module. The samples collected during this test were instantaneous grab samples and only truly represent a moment in time. Therefore, there can be some error induced when converting these data to daily representations of the total mass of arsenic processed in the module. Laboratory variation can also be expected to influence daily mass balance calculation. Typical precision for arsenic measurements by ICP-MS is ± 30% as defined in the Quality Assurance Plan. While normal analysis is expected to be somewhat better than ± 30%, the QA criteria for acceptable data was set at this precision level. While sample collection and laboratory variation can be expected to influence the daily mass balance calculation, it would typically be expected that the variation would on both the high and low side of the mass calculation. Unless the sample matrix for the feed water is biased high for all samples, and/or the concentrate and permeate are biased low for all samples, it would not appear that all of the unaccounted for arsenic can be attributed to sample and laboratory variation.

Given the consistent “loss” of arsenic in the mass balance calculation, it is suspected that some arsenic is being retained within the membrane module in particulate form. Some of the insoluble arsenic (about 35 % of the total) is most likely being trapped in the membrane and the membrane is acting as a filter to remove and retain this material. It is also possible that some small portion of the soluble arsenic is converted to an insoluble form or trapped within other insoluble materials as it passes through the

membrane. A possible mechanism for this conversion is that soluble arsenic can combine with the other contaminants, such as iron, become insoluble, and then be filtered and retained by the membrane. The discussion, "Fouling Issues", later in this section, presents the case for possible iron fouling, based on the analysis of the module cleaning solution. The Ligand exchange mechanism, known to facilitate arsenic removal in the presence of ferric hydroxide coagulant chemistries, may account for this apparent arsenic reduction as the feedwater analyses show the presence of small concentrations of iron in the incoming water.

It should be emphasized that the performance of the membrane module throughout the duration of this test was unaffected by any accumulation of insoluble material, regardless of its source. Daily monitoring of the unit showed virtually no decrease in specific flux over the duration of this test. There were no abnormal changes in flows or pressure over the 34-day period and the unit was only cleaned at the end of the test to verify cleaning procedures and confirm the cleaning process could restore the unit to normal operating conditions. The total amount of arsenic potentially retained within the module was calculated as 10,995 mg. The Hydranautics unit handled any loading it received of insoluble materials with no drop in performance.

The importance of recognizing the possible retention of arsenic and other insoluble material within the membrane is that fouling of membranes by insoluble materials is a primary cause of high maintenance cost, frequent cleaning requirements or even membrane failures. Therefore, it is important to recognize these potential issues when selecting this type of technology for a specific water treatment application.

Summary of Arsenic Results

The total arsenic concentration in the feedwater averaged 65 $\mu\text{g/L}$ over the thirty-four day test period. The Hydranautics unit reduced total arsenic to an average of 0.5 $\mu\text{g/L}$ in the treated water. The Hydranautics unit reduced the dissolved arsenic in the feedwater from an average of 42 $\mu\text{g/L}$ to less than 1 $\mu\text{g/L}$ in the permeate (treated water). The dominant arsenic species in the Spiro Tunnel feed water is As (V). The feedwater average concentration of Arsenic (V) was 35 $\mu\text{g/L}$ and was reduced to an average level of 0.5 $\mu\text{g/L}$ in the treated water. Arsenic (V) represented 83% of the dissolved arsenic present in the feed water. Because it is ionic and stable in the water supply, it is highly rejected by the reverse osmosis membrane module. Arsenic (III) was also rejected by the membrane, reducing the average feedwater level from 7 $\mu\text{g/l}$ to 0.5 $\mu\text{g/l}$ in the permeate.

The Hydranautics module demonstrated an average total arsenic rejection of 99% and met the goal of achieving a minimum of 98% rejection or removal of total arsenic from the feed water. Some of the total arsenic rejection was probably achieved by trapping insoluble arsenic within the membrane. While "filtering" insoluble material is not the primary use for a RO membrane system and can lead to fouling problems, there was no indication of any significant fouling of the Hydranautics unit during the duration of this test. The speciated and soluble arsenic results clearly show that the predominate rejection of arsenic by the membrane system was the soluble arsenic forms. Dissolved arsenic rejection averaged 98% during the verification period. Rejection/removal of these soluble salts is the primary application for reverse osmosis technology.

Antimony Removal

The Park City Municipal Corporation had expressed concern about elevated levels of antimony in the Bulkhead water source, so the daily water analyses included antimony data. The membrane consistently removed antimony to below the minimum detection level (MDL) of 3.0 µg/L. Table 4-21 lists the daily concentrations of antimony in all three streams (feed, concentrate and permeate) and these data are plotted in Figure 4-7. All of the antimony permeate concentrations were below 3.0 µg/L, the reported MDL. The solute rejection percentages are calculated using a value of 3.0 µg/l. As in the case of Arsenic (III), the percent rejection data are strongly influenced by the relatively low feed water concentrations as compared to the MDL for antimony in the permeate. The Hydranautics unit achieved the highest possible rejection percentage that could be achieved given that all permeate values were below the MDL. The maximum antimony feed water concentration was 9.2 µg/l and the MDL was 3.0 µg/l; therefore, the maximum rejection percentage that could be calculated was 67%. It is probable that the actual antimony concentration in the permeate was significantly less than the 3.0 µg/l used in the calculation, but it is not possible to state conclusively how much better the rejection percentage might be.

Table 4-21: Antimony Concentrations in Feed, Concentrate and Permeate Streams

Date	Antimony Readings (µg/L)				% Rejection ¹
	Feed	Concentrate	Permeate		
3/15/00	8.6	11.0	<3.0	65	
3/16/00	8.5	10.0	<3.0	65	
3/17/00	8.4	9.8	<3.0	64	
3/18/00	8.7	10.0	<3.0	66	
3/19/00	8.522	10.0	<3.0	65	
3/20/00	8.8	10.0	<3.0	66	
3/21/00	8.8	9.4	<3.0	66	
3/22/00	8.8	9.9	<3.0	66	
3/23/00	8.4	10.0	<3.0	64	
3/24/00	8.7	9.7	<3.0	66	
3/25/00	8.4	9.7	<3.0	64	
3/26/00	8.4	9.5	<3.0	64	
3/27/00 ²	8.4	<3.0	9.7	-	
3/28/00	9.2	10.5	<3.0	67	
3/29/00	9.0	10.7	<3.0	67	
3/30/00	8.3	10.3	<3.0	64	
3/31/00	8.7	10.4	<3.0	66	
4/1/00	8.6	10.0	<3.0	65	
4/2/00	8.1	9.9	<3.0	63	
4/3/00	8.4	9.9	<3.0	64	
4/4/00	8.8	10.0	<3.0	66	
4/5/00	8.5	9.8	<3.0	65	
4/6/00	8.6	9.9	<3.0	65	
4/7/00	8.5	9.9	<3.0	65	
4/8/00	8.7	10.1	<3.0	66	
4/9/00	8.8	10.4	<3.0	66	
4/10/00	8.5	9.9	<3.0	65	
4/11/00	8.6	10.4	<3.0	65	
4/12/00	8.9	10.4	<3.0	66	
4/13/00	9.1	10.3	<3.0	67	
4/14/00	8.8	10.4	<3.0	66	
4/15/00	8.7	10.1	<3.0	66	
4/16/00	9.0	10.5	<3.0	67	
4/17/00	8.9	10.4	<3.0	66	

1) Based on utilization of the MDL of 3.0 as permeate concentration
 2) Indicates likely mislabeled sample containers of concentrate and/or permeate.

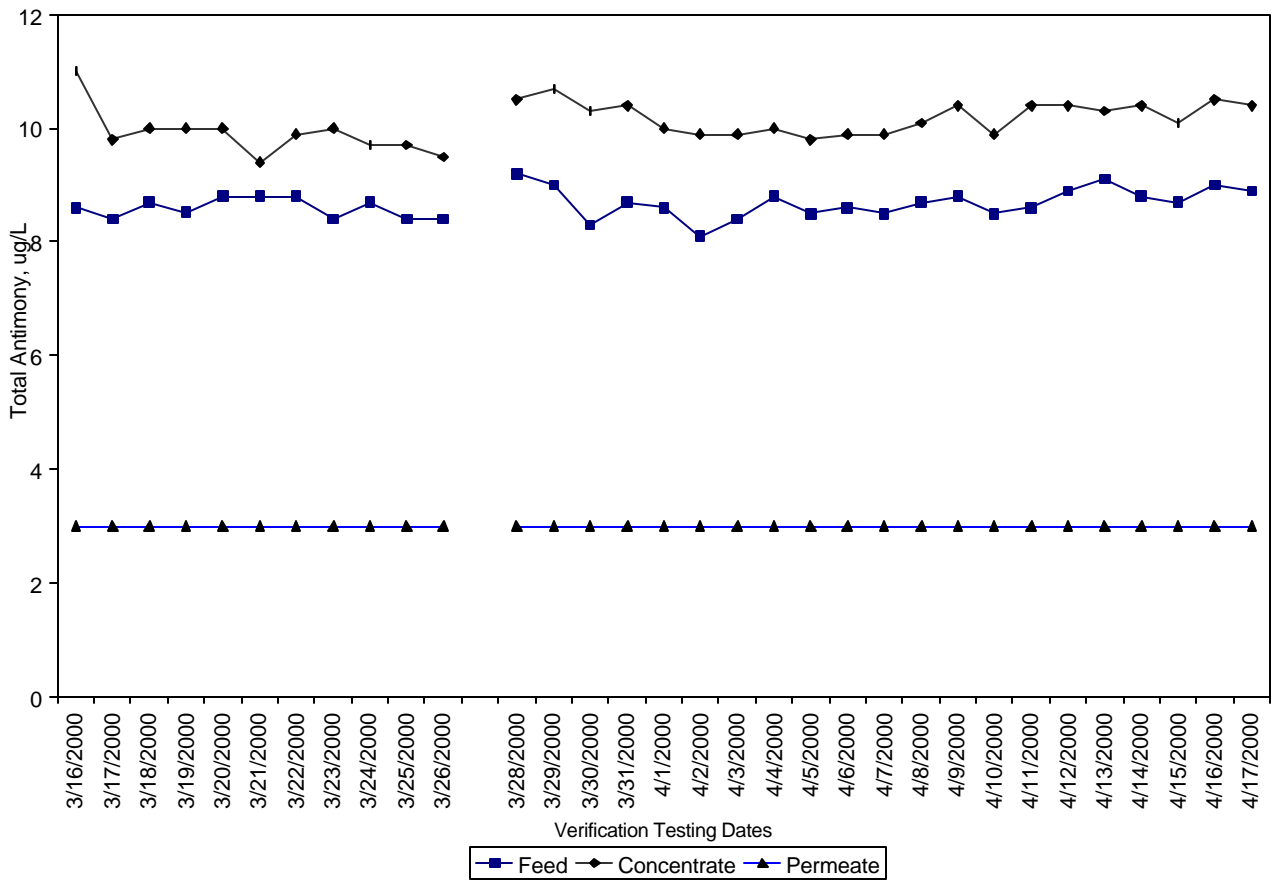

Figure 4-7: Antimony Concentration vs. Time

(Data from likely mislabeled containers are not included in this figure.)

pH Readings

pH measurements of the feed, concentrate and permeate streams were made on-site on a daily basis. The permeate pH is virtually always lower than the feed pH because reverse osmosis technology removes salts, thereby reducing the buffering capacity. Also, the higher purity, more aggressive property of the permeate results in dissolution of carbon dioxide from the air, forming carbonic acid in the relatively unbuffered water and lowering the pH. Table 4-22 lists these data, Table 4-23 summarizes these data and Figure 4-8 graphically represents these data.

Table 4-22: pH Data vs. Time

Date	Feed	Concentrate	Permeate
3/15/00	7.43	7.45	5.58
3/16/00	7.42	7.49	5.41
3/17/00	7.48	7.40	5.30
3/18/00	7.39	7.50	5.60
3/19/00	7.51	7.45	5.00
3/20/00	7.43	7.43	5.26
3/21/00	7.38	7.42	5.24
3/22/00	7.36	7.43	5.43
3/23/00	7.32	7.36	5.47
3/24/00	7.24	7.33	5.42
3/25/00	7.32	7.34	5.69
3/26/00	7.23	7.41	5.41
3/27/00	7.29	7.37	5.75
3/28/00	7.31	7.43	6.10
3/29/00	7.18	7.28	5.33
3/30/00	7.47	7.41	5.18
3/31/00	7.26	7.19	5.36
4/1/00	7.35	7.41	6.74
4/2/00	7.22	7.34	5.50
4/3/00	7.25	7.38	5.72
4/4/00	7.23	7.32	5.58
4/5/00	7.33	7.36	5.74
4/6/00	7.38	7.27	5.63
4/7/00	7.35	7.41	5.61
4/8/00	7.44	7.44	5.43
4/9/00	7.25	7.48	5.60
4/10/00	7.22	7.32	5.27
4/11/00	7.43	7.32	5.51
4/12/00	7.23	7.29	5.67
4/13/00	7.33	7.41	5.68
4/14/00	7.26	7.33	5.68
4/15/00	7.28	7.31	5.43
4/16/00	7.24	7.30	5.59
4/17/00	7.33	7.37	5.87

Table 4-23: pH Data Summary

	Feed	Concentrate	Permeate
Minimum	7.18	7.19	5.00
Maximum	7.51	7.50	6.74
Average	7.33	7.38	5.55
Standard Deviation	0.0879	0.0698	0.300
Confidence Interval	(7.30, 7.36)	(7.36, 7.40)	(5.45, 5.65)

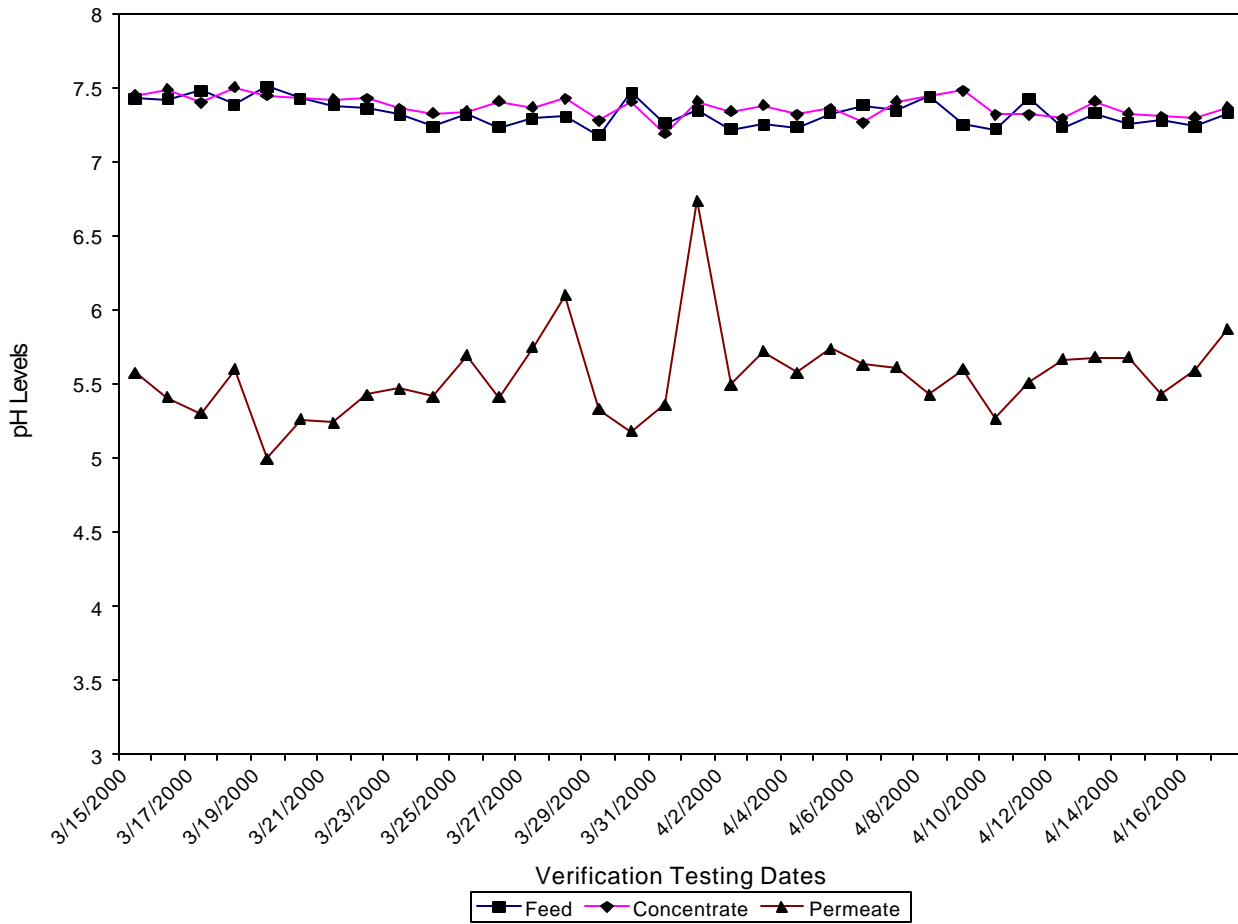

Figure 4-8: pH Concentrations over Testing Period

Fouling Issues

The iron concentration in the Spiro Tunnel Bulkhead water supply ranged from 0.118 to 0.255 mg/L, considered to be of moderate concern in a spiral-wound reverse osmosis membrane system (iron concentrations above 0.3mg/L require pretreatment). The slight decrease in permeate rate (5%) over 34 days may be the result of iron hydroxide fouling. Ferric hydroxide will readily form in an oxidizing environment at neutral or higher pH levels. It is one of the most common contributors to membrane

fouling in groundwater treatment applications. Fortunately, Fe (OH)₃ can be readily removed with acidic cleaning solutions.

Table 4-24 lists the weekly iron data collected during this test. The Hydraulics unit effectively rejected iron, yielding a permeate with less than 0.02 mg/l iron. Given the good rejection of iron by the membrane unit, it would be expected that the iron concentration in the concentrate would increase and be higher than the feed water. As can be seen in Table 4-24, this is not the case. In similar manner as was described earlier for the total and dissolved arsenic data, mass balances were performed for the iron data to more closely evaluate the results.

Table 4-24: Iron Concentrations

Date	Feed (mg/L)	Concentrate (mg/L)	Permeate (mg/L)
3/20/00	0.255	0.198	<0.02
3/27/00	0.128	0.109	<0.02
4/4/00	0.14	0.0945	<0.02
4/10/00	0.131	0.0925	<0.02
4/17/00	0.118	0.125	<0.02

Table 4-25 shows the results for the mass balance calculations. The same formula and conversion factors that were used for arsenic calculations were used for these calculations. Flow data were converted to liters per day and sample results were assumed to represent a twenty-four hour period. The mass of iron present in the water streams could then be compared and balanced on a daily basis. As can be seen, the mass of iron entering the system on each of the five monitoring days is consistently higher than the mass of iron exiting the system in the concentrate and permeate.

Table 4-25: Estimated Mass of Iron Retained in Module

Date	Feed Mass $Q_f C_f$ (mg/day)	Concentrate Mass $Q_c C_c$ (mg/day)	Permeate Mass $Q_p C_p$ (mg/day)	Difference Feed- (Concentrate + Permeate) (mg/day)
3/20/00	7172	4748	82.85	2340
3/27/00	3725	2703	86.12	936.2
4/4/00	4067	2344	85.03	1639
4/10/00	4077	2486	85.03	1506
4/17/00	3499	3188	82.85	227.4

Q_f = Feed Flow Rate (L/day)

Q_c = Concentrate Flow Rate (L/day)

Q_p = Permeate Flow Rate (L/day)

C_f = Feedwater Concentration (mg/L)

C_c = Concentrate Concentration (mg/L)

C_p = Permeate Concentration (mg/L)

The last column of Table 4-25 shows the estimated amount of iron that may be retained within the module. These data show that an average of approximately 1330 mg of iron is retained each day. Using the average of the five data points and multiplying by the 34-day test period, it can be estimated that approximately 45 grams of iron may be retained within the module.

These results are only approximations for three reasons:

- 1) Every permeate reading was below the MDL (0.02 mg/L) for iron. The calculation assumed that the total iron concentration in the permeate was 0.02 mg/L, but it may have been much less.
- 2) The analyses measured total iron, rather than $\text{Fe}(\text{OH})_3$. The actual compound that precipitated was probably a complexed ferric hydroxide, with one or more As (V) ions attached, as it is well known that ferric hydroxide will exchange one or more OH^- ions for As (V) ions (Ligand exchange).
- 3) The calculations for the retention of iron for the entire test period are based on only five data points. The daily iron results did vary and the assumption that the average of the five data points represents the entire test period could be significantly biased.

Additional data on possible iron precipitation are available from the analysis of the membrane cleaning solution following the cleaning operation on April 17. Total iron was measured in the cleaning solution and found to be present at 466.0 mg/L. Reverse osmosis permeate was used to prepare the cleaning solution so there was little or no iron added from the makeup water. The Certificate of Analysis for the citric acid shows the iron concentration to be “<50 mg/kg.” Assuming an iron concentration of 50 mg/kg to be present, this would contribute only 0.193g iron to the cleaning solution. A reasonable conclusion, therefore, is that the membrane module retained a considerable quantity of iron.

Two modules were cleaned simultaneously. Based on the concentration of the total iron in the 50 gallons of spent cleaning solution, the quantity of iron extracted from each module (assuming equal accumulation in each module) was approximately 44 grams or a total of 88 grams for the entire system. The estimated accumulation of iron from the earlier calculations was 45 grams for the 34-day period. Given the variation in iron concentrations, the use of 5 days data to project the entire test period, and other variables, these two estimates are relatively close to each other.

The data strongly suggest that some accumulation of iron, probably as iron hydroxide was occurring throughout the test. Iron fouling of RO membrane units is a common occurrence and can be expected. In the case of the Hydranautics unit, any iron accumulation or fouling that was occurring during the test period was handled without difficulty by the unit. The permeate flow rates, operating pressures, and specific flux remained stable during the 34 day test period. Given these test results, it could be expected that the Hydranautics unit would require cleaning due to an accumulation of iron and other contaminants within the membrane. The cleaning cycle test showed that the iron could be removed from the unit and operating conditions restored to original “clean” membrane conditions. Thus, while accumulations of fouling contaminants appear to have occurred during the test, they did not cause any significant operational difficulty and do not appear to require more frequent cleaning of the unit,

Other Parameters

On a weekly basis, samples were submitted to the State Laboratory to be analyzed for the following parameters:

- Fluoride
- Total iron
- Manganese
- Sulfate

The Test Plan required the parameters listed below to be measured once during the one-month duration of the test:

- Alkalinity
- LSI
- Turbidity
- TSS
- TOC
- Silica (total)

In addition, the following parameters were measured during the test period:

- Magnesium
- Chloride

The above data are summarized in Table 4-26. It should be noted that virtually all permeate readings were at or below the MDL for almost all of the parameters. The Hydraulics unit was very effective in rejecting all of the salts and other contaminants that were monitored to describe overall water quality. The permeate produced from the unit showed excellent water quality.

The operational data indicate that insignificant fouling occurred during the test period. A quantity of precipitated iron was recovered from the module, but it would appear that none of the other parameters listed in Table 4-26 had an effect on the Membrane Element Module performance.

Table 4-26: Weekly Analytical Parameters

Date	Fluoride (mg/L)			Iron (total)(mg/L)			Manganese (mg/L)		
	Feed	Conc.	Perm.	Feed	Conc.	Perm.	Feed	Conc.	Perm.
3/20/00	0.18	0.21	<0.05	0.255	0.198	<0.02	22.6	21.5	<5.0
3/27/00	0.16	0.22	<0.05	0.128	0.109	<0.02	13.1	14.9	<5.0
4/4/00	0.158	0.185	<0.05	0.14	0.0945	<0.02	13.6	15.6	<5
4/10/00	0.157	0.192	<0.05	0.131	0.0925	<0.02	13.4	15.2	<5
4/17/00	-	-	-	0.118	0.125	<0.02	15	16.8	<5

Date	Sulfate (mg/L)			Alkalinity (mg/L)			LSI (L.Ind.)		
	Feed	Conc.	Perm.	Feed	Conc.	Perm.	Feed	Conc.	Perm.
3/20/00	265.9	323.5	<20.0	145	171	3	0.32	0.47	-4.92
3/27/00	288.0	309.0	<20.0	-	-	-	-	-	-
4/4/00	277.0	281.0	<20.0	-	-	-	-	-	-
4/10/00	280.0	292.0	<20.0	-	-	-	-	-	-
4/17/00	-	-	-	144	163	6	-	-	-

Date	Turbidity (NTU)			TSS (mg/L)			Silica (total)(mg/L)		
	Feed	Conc.	Perm.	Feed	Conc.	Perm.	Feed	Conc.	Perm.
3/20/00	1.44	1.14	<0.1	<4.0	<4.0	<4.0	20.2	23.8	<1.0
3/23/00	-	-	-	-	-	-	20.3/19.2	23.4/22.4	<1.0/<1.0
4/17/00	0.35	0.27	0.09	-	-	-	19.6	22.7	<1.0

Date	TOC (mg/L)			Magnesium (mg/L)			Chloride (mg/L)		
	Feed	Conc.	Perm.	Feed	Conc.	Perm.	Feed	Conc.	Perm.
3/20/00	<0.5	<0.5	<0.5	39.5	45.8	<1	-	-	-
4/4/00	-	-	-	39.6	46.3	<1.0	-	-	-
4/17/00	-	<0.5	<0.5	-	-	-	5.5	7	<3

4.4 Results of Equipment Characterization

During verification testing, the factors associated with the qualitative, quantitative and cost characteristics of the equipment were identified, within the limits of the short duration of the test.

4.4.1 Qualitative Factors

The qualitative factors examined were the susceptibility of the equipment to environmental condition changes, operational reliability and equipment safety.

4.4.1.1 Susceptibility to Changes in Environmental Conditions

Changes in environmental conditions that cause changes in feedwater quality can affect the performance of reverse osmosis membrane modules. Since the rejection of dissolved salts is always a percentage of the concentration of salts at the membrane surface, any changes in the feedwater concentration will affect permeate quality. As long as the salts remain soluble, they will not degrade the membrane.

Suspended solids in the feedwater are generally effectively removed by the 5µ prefilter cartridges; however, if filter break-through occurs or the cartridges become so loaded as to reduce flow through

them, the membrane element modules can become fouled. Fouling can also occur in that the concentration effects of the reverse osmosis equipment can cause precipitation of insoluble salts. If excessive fouling occurs, chemical cleaning may not restore the flux to an adequate level and the membrane elements will require replacement.

In this test, in spite of the wide variation in SDI readings after the prefilter cartridges (Table 4-6, Figure 4-2), the membrane element module required cleaning only at the end of the test period, and the performance was completely restored by the cleaning operation.

Since the water source was groundwater, even though ambient conditions were changing, the feedwater temperature remained unchanged throughout the test. Also, the test unit was located indoors, so it was unaffected by weather changes.

4.4.1.2 Operational Reliability

The equipment ran continuously throughout the duration of the test, meaning that the high-pressure pump was running during this time. It was turned off for approximately five minutes at a time for prefilter cartridge replacement.

From system startup until April 2, the prefilter cartridges were replaced every other day. During the night of April 1, a turbidity spike to almost 12 NTU resulted in the cartridges becoming so fouled as to cause the membrane pressures to drop to 50 psi (there was no evidence that any other chemical parameter caused the fouling). Replacing the filter cartridges eliminated the problem, and from that day until the termination of the test on April 17, the cartridges were changed daily. The cleaning that took place on April 17 was performed manually.

The daily changing of the prefilter cartridges was established after April 1 turbidity spike to ensure that the Rosy-200 pilot test unit would be able to maintain feedwater pressure on a continuous basis. On-site support for monitoring the prefilter status (manual prefilter unit) was only available during the daytime periods. Thus, frequent changing of the prefilter was performed whether or not there were any signs of pressure drop or plugging. It would be expected that an automated pre-filter system or 24 hour staff coverage would be available in a full-scale water plant. Based on the typical turbidity levels monitored on most days it could be expected that prefilter cartridge life would be much longer than one day. The actual prefilter changing schedule will be dependent on the quality of the water supplied to the prefilter cartridge system.

Once flows, pressures and water recovery conditions were established during the Initial Operations Period, no adjustments were made throughout the duration of the test.

4.4.1.3 Equipment Safety

Evaluation of the safety of the treatment system was done by examination of the components of the system and identification of hazards associated with these components. A judgment as to the safety of the treatment system was made from these evaluations.

There are safety hazards associated with high voltage electrical service and pressurized water. The electrical service was connected by a qualified electrical contractor according to local code requirements and did not represent an unusual safety risk. The water pressure inside the treatment system was 150 psi. All personnel were cautioned not to stand at the ends of the pressure vessel (membrane housing). The pressure vessel was manufactured and tested to ASME standards for a maximum operating pressure of 300 psi.

The cleaning chemical, citric acid, is a hazardous chemical. The use of appropriate personal protective equipment (PPE) minimizes the risk of exposure to this substance. The prompt and proper clean up of spills minimizes the hazards associated with this chemical.

No injuries or accidents occurred during the testing.

4.4.2 *Quantitative Factors*

Quantitative factors examined during the verification testing were power, consumables, waste disposal and length of operating cycle.

4.4.2.1 Electrical Power

The electrical power used was 230VAC, 3 phase, 20A service. The total power was recorded on an Amprobe Kilowatt/Hour Meter (non-demand). To calculate power consumption, the meter reading was multiplied by 20, as specified in the meter manual (Appendix B). For the duration of the test (not including the membrane cleaning activity) a total of 181.480 kWh was consumed $[(11.558 - 2.484) \times 20]$. Since two membrane element modules were tested simultaneously and both run at the same pressure, it is assumed that each module consumed one-half of the total power, or 90.740 kWh $(181.480 \div 2)$. For the Hydranautics ESPA2-4040 Reverse Osmosis Membrane Element Module, 2.732 kWh per day was consumed (total test period = 797 hours). If the five minutes per day for filter cartridge replacement are ignored, the electrical usage was 0.114 kWh per hour.

4.4.2.2 Consumables

The consumables included prefilter cartridges and the citric acid cleaning chemical. The prefilter cartridge requirement was one 5 μ (nominal) 20" long cartridge per day (one for each module tested). The citric acid cleaning chemical was USP quality. The quantity required was a 2% (wt/wt) solution (8.5 lb/50 gallons permeate) per module.

If pH adjustment to minimize calcium carbonate formation was utilized, approximately 1.8 Lb. per day of HCl would be required for a unit operating at 80% recovery

4.4.2.3 Waste Disposal

The wastes generated during the verification testing period were the concentrate stream at approximately 4.5 gpm (215,190 gallons total) and 50 gallons of cleaning solution (citric acid and water). Both were directed to the Snyderville Sewer Improvement District, which treats all wastewater

from the Park City Municipal Corporation. The citric acid cleaning solution was diluted with reverse osmosis concentrate to meet the regulated pH discharge standard.

4.4.2.4 Length of Operating Cycle

Spiral-wound reverse osmosis membrane element modules are designed to operate continuously, if possible. The pretreatment requirements and chemical cleaning frequency are dictated by the feedwater quality. For this water supply, 5 μ (nominal) filter cartridges provided sufficient prefiltration, and to prevent irreversible fouling, a chemical cleaning frequency of once per month proved to be adequate. In a large automated system, a “fast flush” feature would be incorporated. This feature automatically flushes the membrane surfaces at low pressure and low recovery for about 10 minutes normally once per day.

4.5 QA/QC Results

The results of QA/QC verification performed on in-line instrumentation, hand-held instruments and the analytical Laboratory are presented below.

4.5.1 *In-Line Thermometer*

Temperatures were measured in accordance with SM 2550 two times daily, with a Tel-Tru NIST traceable thermometer mounted between the high-pressure pump and the membrane element module. The temperature read a constant 49°F (9.4°C) throughout the duration of the test.

4.5.2 *Conductivity Monitor*

The hand-held Myron L Ultrameter Model P (serial #6 EVAL) conductivity monitor was sent to the manufacturer for calibration prior to the start of the verification testing. On a daily basis, the monitor was also calibrated with standard solutions from the manufacturer: 18, 170 and 700 μ S/cm conductivity. This monitor was used to obtain the conductivity data for osmotic pressure calculations. The certificates of calibration for the conductivity monitor and NIST traceability are located in Appendix F.

4.5.3 *Pressure Gauges*

Pressure gauges were originally mounted on the inlet and outlet of the 5 μ prefilter housing as well as on the feed and concentrate sides of the membrane element model. An evaluation of the accuracy of these gauges revealed that they all were inadequate, so the gauges were removed and replaced with quick-disconnect fittings to allow all pressure readings to be made with glycerin-filled NIST traceable gauges installed for each reading. The prefilter pressures were read with a 0-60 psig Ametek Module No. 1980L (Certificate #0084-6); the membrane pressures were read with a 0-200 psig Ametek Model 1980L (Certificate #0068-7). Certificates of calibration are located in Appendix F.

4.5.4 Flow Monitoring

The test unit was equipped with panel mounted acrylic flow meters to read permeate and concentrate flow rates; however, the accuracy of these meters was determined to be too poor to use, so the “bucket and stopwatch” flow rate procedure was utilized for all flow measurements. The permeate and concentrate lines were equipped with three-way valves which allowed the total flow to be diverted for these measurements, which were made two times per day.

4.5.5 pH Meter

pH readings were made in accordance with SM 4500-H⁺ on an Oakton® WD-35615-Series meter. A three-point calibration (pH 4, 7 and 10) with NIST traceable pH buffers was performed daily. Between tests, the pH probe was kept wet in KCl solution. Field procedures were used to limit the absorbance of carbon dioxide to avoid skewing results by poorly buffered water.

The unit was calibrated against a standardized pH instrument in the State of Utah Laboratory and found to be within 5% accuracy.

4.5.6 Turbidity Instrumentation

Turbidity readings were required only once per month; however, readings on the raw water (before filter cartridges) were taken almost daily from the Spiro Treatment Plant wall mounted in-line turbidimeter (HF Scientific, Inc, Micro 200) and also measured with a Hach 2100P benchtop turbidimeter. The benchtop turbidimeter was calibrated at the start of testing and then weekly against primary standards. Manufacturer’s procedures for maintenance were followed and the schedules for maintenance and cleaning noted in the logbook. All glassware was dedicated and cleaned with lint free tissues to prevent scouring or deposits on the cells. Secondary standards (0.0, 0.4 and 20.0 NTU) were used to calibrate the turbidimeter with each use. Standard Methods 2130 was employed for measurement of turbidity.

Disturbances in the tunnel resulted in wide variances in turbidity readings, including the occasional spike. The wall-mounted meter was scheduled to be cleaned weekly, although the data indicate that this may not have been frequent enough.

The State Laboratory analyzed the membrane feed, concentrate and permeate stream turbidities twice during the period of the test. In both cases, the permeate turbidity was at or below the minimum detection level of 0.1 NTU.

4.5.7 Tubing and Fittings

The tubing and fittings associated with the treatment system and wall mounted turbidimeter were inspected to verify that they were clean and did not have any holes or cracks in them. Also, the tubing was inspected for brittleness or any condition, which could cause failure.

4.5.8 *Off-Site Analysis of Chemical Samples*

4.5.8.1 Organic Parameters (Total Organic Carbon)

TOC was required to be measured once per month. A total of nine samples were collected on March 20 and April 17. Four samples were improperly preserved; however, all results were below the MDL of 0.5 mg/L.

4.5.8.2 Inorganic Samples

Inorganic samples were collected, held in the refrigerator at 4°C and delivered in accordance with SM 3010B and C and 1060 and EPA §136.3, 40 CFR Ch I, at least twice a week. Proper bottles and preservatives, where required (iron and manganese for example), were used. Although the travel time was brief, samples were shipped in coolers at 4°C. Results of all off-site analyses are listed in Appendix D.

4.5.9 *SDI Measurements*

SDI (Silt Density Index) measurement of the feedwater stream was required to be made once per month. In actuality, nine measurements were made, commencing on March 15 and ending on April 17.

4.5.10 *Arsenic Speciation and Analysis*

On a daily basis, feed, concentrate and permeate samples were collected and speciated on-site. All samples were then delivered to the State Laboratory for analysis. The laboratory analyzed for total arsenic, dissolved arsenic and As (III). As (V) data were obtained by subtracting As (III) readings from the dissolved arsenic figure.

In almost all permeate samples, the dissolved arsenic figures were higher than the total arsenic figures. The State Laboratory investigated this anomaly in detail and postulates that the presence of the H₂SO₄ preservative in bottle b (bottles a and c had HNO₃ preservative) affected the accuracy of the ICP-MS analytical equipment. This explanation, arsenic speciation protocol and Laboratory QA/QC procedures are detailed in Appendix I.

The Quality Control review by NSF raised the question of whether or not the laboratory could actually document a reporting limit of 0.5 µg/l for total arsenic, dissolved arsenic and the arsenic species. The reviewer indicated in the review comments that the sulfate interference had not been proven in his opinion. It was also stated that a reporting limit (actual quantitation limit) is typically 10 – 30 times the MDL. Therefore, a reporting limit of 3-5 µg/l may be more appropriate. At this level, all of the data would be reported as “less than values” for the permeate and the difference between the total and dissolved arsenic would be eliminated. If the reporting limit is raised above 1 µg/l, then rejection or removal efficiencies could not be calculated at the 98% or better level. The feed water contains an average of 65 µg/l total arsenic. Therefore a permeate, reported as containing <3 µg/l, would yield a rejection efficiency of 95.4%.

Chapter 5 References

References consulted in the preparation of this Environmental Technology Verification Report include the following:

“Health Implications of Arsenic in Drinking Water”, Pontius, F.W., Brown, K.G., Chen, C.J., *Journal AWWA*, September, 1994.

“Chemistry of Arsenic Removal During Coagulation and Fe-MN Oxidation”, Edwards, M., *Journal AWWA*, September, 1994.

“Enhanced Coagulation For Arsenic Removal”, Cheng, R.C., Liang, S., Want, H.C., Beuhler, M.D., *Journal AWWA*, September, 1994.

“POU/POE Technologies Available For Arsenic Removal”, Russo, R., *Water Technology*, August, 1998.

“Chromatography Aids in Arsenic Removal”, Badger, T.J., Bergemamann, E.P., Smith, P.K., Datta, R., *Water Technology*, August 1999.

“Arsenic Removal in the 1990’s: Full Scale Experience from Park City Utah”, Gibbs, J.W., Scanlan, L.P., *Proceedings WQTC*, November 1994.

“Crossflow Filtration for Environmental Compliance”, Cartwright, P, (P.E.), *Filtration and Separation*, October 1997

NSF/EPA Test Plan: Chapter 2, *NSF Equipment Verification Testing Plan For The Removal Of Inorganic Chemical Contaminants By Reverse Osmosis Or Nanofiltration*, NSF International, Ann Arbor, Michigan, June 18, 1999.

NSF/EPA Protocol: Chapter 1, *Protocol of Equipment Verification Testing For Arsenic Removal*, NSF International, Ann Arbor, Michigan, May 28, 1999.

Standard Methods for the Examination of Water and Wastewater, 20th edition, (APHA, et. al., 1998)