

US EPA ARCHIVE DOCUMENT

Environmental Technology Verification Report

Physical Removal of *Cryptosporidium*
oocysts and *Giardia* cysts in Drinking
Water

Leopold Membrane Systems
Ultrabar Ultrafiltration System with
60 Inch Mark III Membrane Element
Pittsburgh, PA

Prepared by



NSF International

Under a Cooperative Agreement with
 U.S. Environmental Protection Agency

ET ✓ ET ✓ ET ✓

THE ENVIRONMENTAL TECHNOLOGY VERIFICATION
PROGRAM



U.S. Environmental Protection Agency



NSF International

ETV Joint Verification Statement

TECHNOLOGY TYPE:	MEMBRANE FILTRATION USED IN PACKAGED DRINKING WATER TREATMENT SYSTEMS	
APPLICATION:	GIARDIA AND CRYPTOSPORIDIUM REMOVAL	
TECHNOLOGY NAME:	ULTRABAR ULTRAFILTRATION SYSTEM UTILIZING A MARK III MEMBRANE (60") ELEMENT	
TEST LOCATION:	PITTSBURGH, PA	
COMPANY:	THE F.B. LEOPOLD CO. INC.	
ADDRESS:	227 SOUTH DIVISION STREET ZELIENOPE, PA 16063	PHONE: (724) 452-6300 FAX: (724) 452-1377
WEB SITE:	http://www.fbleopold.com	
EMAIL:	gvegso@fbleopold.com	

The U.S. Environmental Protection Agency (EPA) has created the Environmental Technology Verification (ETV) Program to facilitate the deployment of innovative or improved environmental technologies through performance verification and dissemination of information. The goal of the ETV program is to further environmental protection by substantially accelerating the acceptance and use of improved and more cost-effective technologies. ETV seeks to achieve this goal by providing high quality, peer reviewed data on technology performance to those involved in the design, distribution, permitting, purchase, and use of environmental technologies.

ETV works in partnership with recognized standards and testing organizations; stakeholders groups which consist of buyers, vendor organizations, and permittees; and with the full participation of individual technology developers. The program evaluates the performance of innovative technologies by developing test plans that are responsive to the needs of stakeholders, conducting field or laboratory tests (as appropriate), collecting and analyzing data, and preparing peer reviewed reports. All evaluations are conducted in accordance with rigorous quality assurance protocols to ensure that data of known and adequate quality are generated and that the results are defensible.

NSF International (NSF) in cooperation with the EPA operates the Package Drinking Water Treatment Systems (PDWTS) program, one of 12 technology areas under ETV. The PDWTS program recently evaluated the performance of a membrane filtration system used in package drinking water treatment system applications. This verification statement provides a summary of the test results for The F.B. Leopold Company Inc.'s (Leopold) Ultrabar Ultrafiltration System. The specific model tested utilized a

60 inch membrane element with a Mark III series flow configuration (Leopold Ultrabar Mark III Ultrafiltration System). Gannett Fleming, Inc., an NSF-qualified field testing organization (FTO), performed the verification testing.

ABSTRACT

Verification testing of the Leopold Ultrabar Mark III Ultrafiltration System was conducted from February 3 to March 9, 1999. The performance claim evaluated during field testing of the Leopold Ultrabar Mark III Ultrafiltration System was that the system is capable of a minimum 3 log₁₀ removal of *Giardia* cysts and 2 log₁₀ removal of *Cryptosporidium* oocysts. The treatment system underwent microbial challenge testing on March 19, 1999, and demonstrated a 4.9 log₁₀ removal of *Giardia* cysts and a 5.8 log₁₀ removal of *Cryptosporidium* oocysts. The log₁₀ removals were limited by the amount of the cysts and oocysts which were present in the stock feed solution, the percentage of the permeate that could be sampled, and the percent recovery of the analytical methodology. There were no *Giardia* cysts or *Cryptosporidium* oocysts observed in the permeate. Source water characteristics were: turbidity average 0.09 Nephelometric Turbidity Units (NTU), pH 7.8, and temperature 3.9°C. During the thirty-day verification test, the system was operated at a flux recommended by the manufacturer of 79 gallons per square foot per day (gfd) at 39°F which equates to 128 gfd at 68°F (133 liters per square meter per hour (l/m²/h) at 3.9°C, 216 l/m²/h at 20°C). The average transmembrane pressure was 9.8 pounds per square inch (psi) (0.68 bar [b]). The feed water recovery of the treatment system during the study was 98%. Chemical cleaning of the treatment system was conducted as part of the verification testing.

TECHNOLOGY DESCRIPTION

Ultrafiltration (UF) processes are generally used to remove microbial contaminants such as *Giardia* and *Cryptosporidium* and other particulate contaminants from drinking water. The Leopold Ultrabar Mark III ultrafiltration membrane is a hollow fiber made of modified polyethersulfone. It has a 0.01µm nominal pore size and utilizes inside-out flow. Water is applied under pressure to the inside of the hollow fiber membrane. The membrane consists of a thin film acting as a sieve. The membrane is a mechanical barrier, providing removal of particulate contaminants. Permeate (filtered water) is collected from the outside of the fiber and carried to the permeate outlet.

The Leopold Ultrabar Ultrafiltration System is a self-contained stand alone system installed in a 20-foot long sea-going (watertight) container. The container is heated, insulated and has lighting and electrical receptacles. The unit's floor is self-draining and the double doors are gasketed and lockable. The only required connections are for the water supply, a sewer connection for the discharge of backwash and chemical cleaning wastes and electrical service. The treatment system consists of two membrane modules, supply pump, feed water and backwash reservoirs and pumps, chemical cleaning equipment and necessary gauges and controls. The treatment system is capable of operating in an automatic mode with limited operator intervention.

For this test program, a dead end filtration mode was used. In dead end mode, all the water exits through the porous hollow fiber at a selected flow rate. During the filtration cycle the feed flow rate equaled the permeate flow rate. To maintain stable flow over the short term, a backwash cycle was performed. At a preset time, determined by raw water quality, the membrane was backwashed. This was accomplished by reversing the flow direction; forcing the permeate back through the fibers from outside to inside. Approximately once per week a chemically enhanced backwash was performed. Although the procedure was varied somewhat during the verification testing, the enhanced backwash generally consisted of a 30 second backwash with permeate, followed by a 45 second backwash with permeate to which 200 mg/l of NaOCl was added, then allowing the membrane to soak in the 200 mg/l NaOCl solution for 5 minutes, and finally a 45 second rinse with permeate.

VERIFICATION TESTING DESCRIPTION

Test Site

The verification testing site was the Pittsburgh Water and Sewer Authority's (PWSA's) open air Highland Reservoir No. 1, Pittsburgh, Pennsylvania. The source water for the verification testing was treated surface water drawn from the Allegheny River. It underwent coagulation, sedimentation, filtration, and disinfection at PWSA's Aspinwall Treatment Plant prior to being pumped to the Highland Reservoir No. 1. The influent to the treatment unit was drawn from the reservoir effluent lines. The verification testing was limited to the performance of the equipment to remove *Cryptosporidium* oocysts and *Giardia* cysts, because the source water was obtained from an open reservoir.

Methods and Procedures

All field analyses (i.e. pH, turbidity, chlorine residual, temperature) were conducted daily using portable field equipment according to Standard Methods for the Examination of Water and Waste Water, 18th Ed., (APHA, et. al., 1992). Likewise, Standard Methods, 18th Ed., (APHA, 1992) and Methods for Chemical Analysis of Water and Wastes (EPA, 1979) were used for analyses conducted in PWSA's laboratory. These analyses included total alkalinity, total hardness, total organic carbon (TOC), dissolved organic carbon (DOC), total dissolved solids (TDS), total suspended solids (TSS), algae (number and species), Ultraviolet Absorbance at 254 nanometers (UVA₂₅₄), total coliform, and heterotrophic plate counts (HPC). Total alkalinity, total hardness and TDS analyses were conducted monthly. All other laboratory parameters were analyzed weekly.

Microbial challenge was performed using *Giardia* cysts and *Cryptosporidium* oocysts. Procedures developed by EPA for use during the Information Collection Rule (ICR) were employed for the identification and enumeration of *Giardia* cysts and *Cryptosporidium* oocysts (EPA, ICR Microbial Laboratory Manual, EPA, April 1996). The protozoans were added to a fifty (50) gallon (190 liter) drum. This drum was filled with the feed water. A total of 13,800,000 *Giardia* cysts and 98,947,000 *Cryptosporidium* oocysts were added to the feed water reservoir. The turbidity of the feed water was 0.09 NTU at the beginning of the microbial removal challenge testing and decreased to 0.06 NTU at the conclusion of the testing. This stock suspension was constantly mixed using a drum mixer. A diaphragm pump was used to add the protozoans to the membranes on the pilot unit. The pump was operated at about 0.85 gallons per minute (gpm) (3.2 liters per minute) and was capable of overcoming the pressure in the feed water line of the pilot unit. Samples of the permeate were collected using a polypropylene wound filter with a nominal pore size of 1.0 μm . One thousand liters (264 gallons) of permeate water were filtered through the sampling vessel at one gpm (3.8 liters per minute). In addition, aliquots of the stock suspension were collected and analyzed to calculate concentrations of the microbes in the feed water. Backwash was delayed until the end of the collection period. Samples of the backwash were collected and analyzed to verify that the parasites were added to the system and removed by the filters.

VERIFICATION OF PERFORMANCE

System Operation

The treatment system was fully automated and capable of normal operations without manual intervention. The unit automatically operates in the filtration and backwash modes. All operational data, flows, pressures, turbidity, and particle counts are recorded on data logging software. Manual intervention is required for chemical cleaning and to occasionally refill the tank of sodium hypochlorite used during chemically enhanced backwash.

The system was operated at a flux recommended by the manufacturer, 79 gfd at 39°F which equates to 128 gfd at 68°F (133 l/m²/h at 3.9 °C, 216 l/m²/h at 20 °C. The flow rate was recorded twice per day and the water temperature was recorded once per day. The flow rate of the treatment system averaged 41 gpm (160 liters per minute).

The feed and permeate pressures were recorded twice per day. The average feed pressure was 19 psi (1.3 b). The average permeate pressure was 9.1 psi (0.63 b). The amount of pressure lost as the water is filtered through the membrane is referred to as transmembrane pressure (TMP). It is calculated by subtracting the permeate water pressure from the feed water pressure. The average TMP for the system was 9.8 psi (0.68 b). For this test program, a backwash interval of once every 60 minutes was used. Approximately 50 gallons of permeate was used to backwash the membranes.

The percent water recovery of the treatment system during the study was 98%. This figure was calculated by comparing the amount of water needed to backwash the membranes to the total amount of water filtered by the system.

The effectiveness of the chemical cleaning process was measured by the recovery of specific flux and loss of original specific flux. Chemical cleaning was conducted at the end of the test period as required by the ETV Protocol for Equipment Verification Testing for Physical Removal of Microbiological and Particulate Contamination (EPA/NSF April, 1998). Data collected before and after the chemical cleaning were used to calculate recovery of specific flux and the loss of original specific flux. The chemical cleaning recovered 11% of the specific flux. The membranes used in the verification testing were placed into service less than one month prior to the beginning of the testing and were not experiencing a significant loss of flux. This may account for the low recovery of specific flux. Data from when the membranes were placed into service and just after cleaning were used to calculate the loss of original specific flux. The loss of original specific flux was 0.43%. This result may be due to the relative age of the membrane and not the effectiveness of the cleaning procedure.

System integrity was demonstrated as required by the ETV protocol. Tests were conducted on an intact membrane system and on one that had been intentionally compromised. The air pressure hold test detected a compromised membrane.

Water Quality Results

During the microbial challenge testing that occurred on March 19, 1999, the Leopold Ultrabar Mark III Ultrafiltration System demonstrated a 4.9 log₁₀ removal of *Giardia* cysts and a 5.8 log₁₀ removal of *Cryptosporidium* oocysts. The log₁₀ removals were limited by the amount of the parasites which were present in the stock feed solution, the percentage of the permeate that could be sampled, and the percent recovery of the analytical methodology. There were no *Giardia* cysts or *Cryptosporidium* oocysts observed in the permeate. During the microbial challenge testing, the feed water characteristics were: turbidity average 0.09 NTU, pH 7.7, temperature 4.7 °C.

During the thirty-day ETV operation of the Leopold Ultrabar Mark III Ultrafiltration System, treatment reductions were seen in HPC, algae, turbidity, and particle counts. HPC concentrations averaged 111 colony forming units (cfu)/100ml in the feed water and 22 cfu/100ml in the permeate. The presence of HPC in the permeate may have been due to inadequate disinfection of the Tygon tubing used for water sampling. Algae concentrations averaged 14 cells/ml in the feed water and <8 cells/ml in the permeate. Turbidity was reduced from an average of 0.09 NTU in the feed water to 0.05 NTU in the permeate. These results were from readings taken from the bench top turbidimeter. The inline permeate turbidimeter did not appear to be operating reliably throughout the verification testing. Particle counts were reduced from an average of 100 total counts/ml in the feed water to an average 3.3 total counts/ml in the permeate.

Total coliform reduction could not be demonstrated due to the absence of total coliforms in the feed water and permeate throughout the test. The following table presents the water quality reductions of the feed water and filtered water samples collected during the 30 days of operation:

Feed Water Quality / Filtered Water Quality Leopold Ultrabar Mark III Ultrafiltration System					
	Total Coliforms (cfu/100 ml)	HPC (cfu/100 ml)	Algae (cells/ml)	Turbidity (NTU)	Particle Counts (particles/ml)
Average ¹	0/0	111/22	14/<8	0.09/0.05	100/3.3
Minimum ¹	0/0	28/8	<8/<8	0.06/0.04	----
Maximum ¹	0/0	188/58	32/<8	0.13/0.10	----
Standard Deviation ¹	0/0	71/21	11/0	0.02/0.00	----
95% Confidence Interval ¹	N/A/ N/A	(48, 173)/ (3, 40)	(4, 23)/ N/A	(0.08, 0.09)/ (0.04, 0.05)	----

¹ – Concentration of feed water/concentration of filtered water.

N/A = Not Applicable because standard deviation = 0

---- = Statistical measurements on cumulative data not calculated.

Note: Calculated averages for less than results (<) utilize half of the Level of Detection (Gilbert, 1987).

Temperature of the feed water was fairly stable during the thirty day testing from a low of 3.3°C to a high of 4.5°C. The average temperature was 3.9°C. The membrane pilot unit had little or no effect on total alkalinity, total hardness, TOC, TSS, TDS, and UVA₂₅₄.

Operation and Maintenance Results

Maintenance requirements on the treatment system did not appear to be significant but were difficult to quantify due to the short duration of the study. There were three interruptions of the process during the testing period. The first interruption occurred February 13 when the FTO's field representative broke the permeate sample line during sample collection. The sample line was broken before the shut off valve and the unit had to be shut down. Repairs were made and the system was restarted on February 16. The second interruption occurred on February 25. The treatment unit's display screen indicated that a low air pressure alarm was the cause of the shutdown. No malfunction of the unit's air system was found. The unit was restarted and back in service February 26. The third failure occurred on February 27. The treatment unit's display screen indicated that a low level in the feed water reservoir had caused the shut down. Due to the lack of available feed flow it was necessary to slightly decrease the flow rate through the unit to maintain operation of the system.

The Operating and Maintenance (O&M) Manual provided by Leopold was available for review on-site and was referenced occasionally during the testing. Particularly, the manual was consulted during the cleaning procedure. The manual was well organized and a valuable resource during the testing period.

Original Signed by
E. Timothy Oppelt 7/27/00
E. Timothy Oppelt Date
Director
National Risk Management Research Laboratory
Office of Research and Development
United States Environmental Protection Agency

Original Signed by
Tom Bruursema 7/28/00
Tom Bruursema Date
General Manager
Environmental and Research Services
NSF International

NOTICE: Verifications are based on an evaluation of technology performance under specific, predetermined criteria and the appropriate quality assurance procedures. EPA and NSF make no expressed or implied warranties as to the performance of the technology and do not certify that a technology will always operate as verified. The end user is solely responsible for complying with any and all applicable federal, state, and local requirements. Mention of corporate names, trade names, or commercial products does not constitute endorsement or recommendation for use of specific products. This report is not a NSF Certification of the specific product mentioned herein.

Availability of Supporting Documents

Copies of the *ETV Protocol for Equipment Verification Testing for Physical Removal of Microbiological and Particulate Contaminants* dated April 20, 1998 and revised May 14, 1999, the Verification Statement, and the Verification Report (NSF Report #00/10/EPADW395) are available from the following sources:

(NOTE: Appendices are not included in the Verification Report. Appendices are available from NSF upon request.)

1. Drinking Water Systems ETV Pilot Manager (order hard copy)
NSF International
P.O. Box 130140
Ann Arbor, Michigan 48113-0140
2. NSF web site: <http://www.nsf.org/etv> (electronic copy)
3. EPA web site: <http://www.epa.gov/etv> (electronic copy)

July 2000

Environmental Technology Verification Report

Physical Removal of *Cryptosporidium* Oocysts and *Giardia* Cysts in Drinking Water

Leopold Membrane Systems Ultrabar Ultrafiltration System with 60 Inch Mark III Membrane Element

Prepared for:

NSF International
Ann Arbor, Michigan 48105

Prepared by

Gannett Fleming
Harrisburg, PA 17106

Under a cooperative agreement with the U.S. Environmental Protection Agency

Jeffrey Q. Adams, Project Officer
National Risk Management Research Laboratory
U.S. Environmental Protection Agency
Cincinnati, Ohio 45268

Notice

The U.S. Environmental Protection Agency (EPA) through its Office of Research and Development has financially supported and collaborated with NSF International (NSF) under Cooperative Agreement No. CR 824815. This verification effort was supported by Package Drinking Water Treatment Systems Pilot operating under the Environmental Technology Verification (ETV) Program. This document has been peer reviewed and reviewed by NSF and EPA and recommended for public release.

Foreword

The following is the final report on an Environmental Technology Verification (ETV) test performed for the NSF International (NSF) and the United States Environmental Protection Agency (EPA) by Gannett Fleming, Inc., in cooperation with The F.B. Leopold Company Inc. The test was conducted during February and March 1999 at the New Highland Pump Station, Pittsburgh Water and Sewer Authority, Pittsburgh, Pennsylvania.

Throughout its history, the EPA has evaluated the effectiveness of innovative technologies to protect human health and the environment. A new EPA program, the Environmental Technology Verification Program (ETV) has been instituted to verify the performance of innovative technical solutions to environmental pollution or human health threats. ETV was created to substantially accelerate the entrance of new environmental technologies into the domestic and international marketplace. Verifiable, high quality data on the performance of new technologies are made available to regulators, developers, consulting engineers, and those in the public health and environmental protection industries. This encourages more rapid availability of approaches to better protect the environment.

The EPA has partnered with NSF, an independent, not-for-profit testing and certification organization dedicated to public health, safety and protection of the environment, to verify performance of small package drinking water systems that serve small communities under the Package Drinking Water Treatment Systems (PDWTS) ETV Pilot Project. A goal of verification testing is to enhance and facilitate the acceptance of small package drinking water treatment equipment by state drinking water regulatory officials and consulting engineers while reducing the need for testing of equipment at each location where the equipment's use is contemplated. NSF will meet this goal by working with manufacturers and NSF-qualified Field Testing Organizations (FTO) to conduct verification testing under the approved protocols.

The ETV PDWTS is being conducted by NSF with participation of manufacturers, under the sponsorship of the EPA Office of Research and Development, National Risk Management Research Laboratory, Water Supply and Water Resources Division, Cincinnati, Ohio. It is important to note that verification of the equipment does not mean that the equipment is "certified" by NSF or "accepted" by EPA. Rather, it recognizes that the performance of the equipment has been determined and verified by these organizations for those conditions tested by the FTO.

Table of Contents

<u>Section</u>	<u>Page</u>
Verification Statement	VS-i
Title Page	i
Notice	ii
Foreword	iii
Table of Contents	iv
Abbreviations and Acronyms	x
Acknowledgements	xii
Chapter 1 Introduction	1
1.1 ETV Purpose and Program Operation	1
1.2 Testing Participants and Responsibilities	1
1.2.1 NSF International	2
1.2.2 Gannett Fleming, Inc.	2
1.2.3 Manufacturer	3
1.2.4 Host and Analytical Laboratory	3
1.2.5 U. S. Environmental Protection Agency	4
1.3 Verification Testing Site	4
1.3.1 Source Water	4
1.3.2 Pilot Effluent Discharge	5
Chapter 2 Equipment Description and Operating Processes	6
2.1 Equipment Description	6
2.2 Operating Process	8
2.2.1 Feed Water	8
2.2.2 Prefiltration	8
2.2.3 Filtration	9
2.2.4 Backwash/Reverse Flow	9
2.2.5 Chemical Cleaning	9
Chapter 3 Methods and Procedures	11
3.1 Experimental Design	11
3.1.1 Objectives	11
3.1.1.1 Evaluation of Stated Equipment Capabilities	11
3.1.1.2 Evaluation of Equipment Performance Relative to Water Quality Regulations	11
3.1.1.3 Evaluation of Operational Requirements	12
3.1.1.4 Evaluation of Maintenance Requirements	12
3.1.2 Equipment Characteristics	12
3.1.2.1 Qualitative Factors	12
3.1.2.2 Quantitative Factors	12
3.1.2.3 Cost Factors	12
3.2 Water Quality Consideration	13
3.2.1 Feed Water Quality	13
3.2.2 Treated Water Quality	14

Table of Contents, continued

<u>Section</u>	<u>Page</u>
3.3 Recording Data	14
3.3.1 Operational Data	14
3.3.2 Water Quality Data	14
3.4 Communications, Logistics and Data Handling Protocol	15
3.4.1 Objectives	15
3.4.2 Procedures	15
3.4.2.1 Log Books	15
3.4.2.2 Chain of Custody	16
3.4.2.3 Inline Measurements	16
3.4.2.4 Spreadsheets	16
3.4.2.5 Statistical Analysis	16
3.5 Recording Statistical Uncertainty	16
3.6 Verification Testing Schedule	17
3.7 Field Operations Procedures	17
3.7.1 Equipment Operations	17
3.7.1.1 Operations Manual	17
3.7.1.2 Analytical Equipment	17
3.7.2 Initial Operations	18
3.7.2.1 Flux	18
3.7.2.2 Transmembrane Pressure	19
3.7.2.3 Backwash	19
3.7.2.4 Treatment Unit Efficiency	19
3.8 Verification Task Procedures	19
3.8.1 Task 1: Membrane Flux and Operation	20
3.8.1.1 Filtration	20
3.8.1.2 Backwash	20
3.8.1.3 Chemical Cleaning	21
3.8.2 Task 2: Cleaning Efficiency	21
3.8.2.1 Cleaning Procedures	22
3.8.3 Task 3: Finished Water Quality	22
3.8.3.1 Sample Collection and Analysis Procedure	22
3.8.4 Task 4: Reporting of Maximum Membrane Pore Size	23
3.8.5 Task 5: Membrane Integrity Testing	23
3.8.5.1 Air Pressure Hold Test	23
3.8.5.2 Turbidity Reduction Monitoring	24
3.8.5.3 Particle Count Reduction Monitoring	24
3.8.6 Task 6: Microbial Removal	24
3.8.6.1 Feed Water Stock Preparation	25
3.8.6.2 Stock Addition Procedure	25
3.8.6.3 Sample Collection Procedure	25
3.9 QA/QC Procedures	25
3.9.1 Daily QA/QC Verification Procedures	25
3.9.1.1 In-line Turbidimeter Flow Rate	26
3.9.1.2 In-line Particle Counter Flow Rate	26

Table of Contents, continued

<u>Section</u>	<u>Page</u>
3.9.1.3 In-line Turbidimeter Readout	26
3.9.2 Bi-Weekly QA/QC Verification Procedures	26
3.9.2.1 In-line Flow Meter Clean Out.....	26
3.9.2.2 In-line Flow Meter Flow Verification.....	26
3.9.3 Procedures for QA/QC Verifications at the Start of Each Testing Period....	27
3.9.3.1 In-line Turbidimeter.....	27
3.9.3.2 Pressure Gauges / Transmitters.....	27
3.9.3.3 Tubing.....	27
3.9.3.4 In-line Particle Counters	27
3.9.4 On-Site Analytical Methods	28
3.9.4.1 pH	28
3.9.4.2 Temperature	28
3.9.4.3 Residual Chlorine Analysis.....	28
3.9.4.4 Turbidity Analysis	29
3.9.5 Chemical and Biological Samples Shipped Off-Site for Analyses.....	29
3.9.5.1 Organic Parameters.....	29
3.9.5.2 Microbiological Parameters	29
3.9.5.3 Inorganic Parameters	30
Chapter 4 Results and Discussion	31
4.1 Introduction	31
4.2 Initial Operations Period Results	31
4.2.1 Flux	31
4.2.2 Transmembrane Pressure	32
4.2.3 Backwash Frequency	32
4.3 Verification Testing Results and Discussion	32
4.3.1 Task 1: Membrane Flux and Operation	32
4.3.1.1 Transmembrane Pressure Results	32
4.3.1.2 Specific Flux Results	34
4.3.1.3 Cleaning Episodes.....	35
4.3.1.4 Percent Feed Water Recovery.....	35
4.3.2 Task 2: Cleaning Efficiency	35
4.3.2.1 Results of Cleaning Episodes.....	36
4.3.2.2 Calculation of Recovery of Specific Flux and Loss of Original Specific Flux	36
4.3.2.3 Discussion of Results.....	37
4.3.3 Task 3: Finished Water Quality	38
4.3.3.1 Turbidity Results and Removal	38
4.3.3.2 Particle Count Results and Removal.....	39
4.3.3.3 Feed and Finished Water Testing Results.....	42
4.3.3.4 Backwash Wastewater Testing Results	44
4.3.3.5 Total Suspended Solids Mass Balance	45
4.3.4 Task 4: Reporting of Maximum Membrane Pore Size	46
4.3.5 Task 5: Membrane Integrity Testing.....	46

Table of Contents, continued

<u>Section</u>	<u>Page</u>
4.3.5.1 Air Pressure Hold Test Results	46
4.3.5.2 Turbidity Reduction Monitoring.....	46
4.3.5.3 Particle Count Reduction Monitoring.....	47
4.3.6 Task 6: Microbial Removal	47
4.3.6.1 Feed Water Concentrations.....	48
4.3.6.2 Permeate Concentrations	48
4.3.6.3 Backwash Examination.....	49
4.3.6.4 Operational and Analytical Data Tables	49
4.3.6.5 Discussion of Results.....	51
4.4 Equipment Characteristics Results	51
4.4.1 Qualitative Factors	51
4.4.1.1 Susceptibility to Changes in Environmental Conditions	51
4.4.1.2 Operational Reliability.....	52
4.4.1.3 Equipment Safety	52
4.4.2 Quantitative Factors	53
4.4.2.1 Power Supply Requirements.....	53
4.4.2.2 Consumable Requirements	53
4.4.2.3 Waste Disposal	53
4.4.2.4 Length of Operating Cycle.....	54
4.5 QA/QC Results	54
4.5.1 Daily QA/QC Results	54
4.5.2 Bi-weekly QA/QC Verification Results	55
4.5.3 Results of QA/QC Verifications at the Start of Each Testing Period	56
4.5.4 Analytical Laboratory QA/QC.....	57
Chapter 5 References.....	58

Table of Contents, continued

<u>Tables</u>	<u>Page</u>
Table 1-1 Leopold Ultrabar Mark III Ultrafiltration System Feed Water Quality.....	5
Table 3-1 Analytical Data Collection Schedule.....	13
Table 3-2 Operational Data Collection Schedule.....	14
Table 3-3 Analytical & Operational Data Collection Schedule - Chemical Cleaning.....	22
Table 4-1 Daily Transmembrane Pressure Readings.....	32
Table 4-2 Specific Flux.....	34
Table 4-3 Chemical and Physical Characteristics of Cleaning Solution.....	36
Table 4-4 Operational Parameter Results - Cleaning Procedure.....	36
Table 4-5 Turbidity Analyses Results and Removal – Bench Top Turbidimeter.....	38
Table 4-6 Feed Water Particle Counts.....	39
Table 4-7 Permeate Particle Counts.....	39
Table 4-8 Daily Average Cumulative Particle Counts Feed and Finished Water, Log ₁₀ Particle Removal.....	40
Table 4-9 Feed Water Testing Results.....	42
Table 4-10 Finished Water Testing Results.....	43
Table 4-11 Daily Backwash Wastewater Testing Results – Summary.....	44
Table 4-12 Weekly Backwash Wastewater Testing Results.....	44
Table 4-13 <i>Giardia</i> and <i>Cryptosporidium</i> Stock Suspension Results by Hemocytometer Counts.....	48
Table 4-14 Feed Water Reservoir Concentrations of <i>Giardia</i> and <i>Cryptosporidium</i> by Microscopic Examination.....	48
Table 4-15 <i>Giardia</i> and <i>Cryptosporidium</i> Challenge Log ₁₀ Removal Calculation.....	49
Table 4-16 Pressure Readings and Calculations During Microbial Removal Testing.....	50
Table 4-17 Specific Flux During Microbial Removal Testing.....	50
Table 4-18 Turbidity Analyses Results and Removal During Microbial Removal Testing.....	50
Table 4-19 Feed Water Particle Counts 3/19/1999.....	50
Table 4-20 Finished Water Particle Counts 3/19/1999.....	50
Table 4-21 Daily Backwash Wastewater Testing Results During Microbial Removal Testing.....	51
 <u>Figures</u>	
Figure 2-1 Flow Schematic.....	7
Figure 4-1 Transmembrane Pressure vs. Time.....	33
Figure 4-2 Specific Flux Decline vs. Time.....	34
Figure 4-3 Four Hour Feed Water Particle Counts.....	41
Figure 4-4 Four Hour Permeate Particle Counts.....	41
Figure 4-5 Daily Average Log ₁₀ Cumulative Particle Removal Graph.....	42
 <u>Photographs</u>	
Photograph 1 Leopold Ultrabar Mark III Ultrafiltration System showing piping, membrane modules, and control panel.....	8

Table of Contents, continued

Appendices

- A. Laboratory Approval Statements
- B. Manufacturer's Operation and Maintenance Manual
- C. Data Spreadsheets
- D. Data Log Book
- E. Laboratory Chain of Custody Forms
- F. PWSA Laboratory QA/QC Plan
- G. Manufacturer's Membrane Pore Size Report
- H. Laboratory Reports and Challenge Testing Reports and Bench Sheets
- I. Particle Counter Information and Pressure Gauge Calibration Report
- J. Pilot Plant Photos
- K. Field Operations Document

Abbreviations and Acronyms

CaCO ₃	Calcium Carbonate
CCP	Composite Correction Program
cfu	Colony forming unit
CIP	Clean in place
Cl ₂	Chlorine
°C	Degrees Celsius
DI	Deionized
DOC	Dissolved Organic Carbon
USEPA	U.S. Environmental Protection Agency
ESWTR	Enhanced Surface Water Treatment Rule
ETV	Environmental Technology Verification
°F	Degrees Fahrenheit
FOD	Field Operations Document
ft	Foot
ft ²	Feet Squared
FTO	Field Testing Organization
FOD	Field Operations Document
gfd	Gallon per square foot per day
gpm	Gallon per minute
HPC	Heterotrophic Plate Count
ICR	Information Collection Rule
In	Inch
L	Liters
Lbs	Pounds
l/h/m ²	Liter per hour per square meter
l/h/m ² /b	Liter per hour per square meter per bar
m	Meter
MG	Million gallon
MGD	Million gallon per day
mg/L	Milligram per liter
ml	Milliliters
mm	Millimeters
NIST	National Institute of Standards and Technology
NSF	NSF International (formerly known as National Sanitation Foundation)
nm	Nanometers
NTU	Nephelometric Turbidity Units
O&M	Operations and Maintenance
PC	Personal computer
PPE	Personal protective equipment
psi	Pounds per square inch
PDWTS	Packaged Drinking Water Treatment System
PWSA	Pittsburgh Water and Sewer Authority
QA/QC	Quality Assurance / Quality Control

SWTR	Surface Water Treatment Rule
TDS	Total Dissolved Solids
TMP	Transmembrane pressure
TOC	Total Organic Carbon
TSS	Total Suspended Solids
UF	Ultrafiltration
µm	Micron
UV ₂₅₄ (UVA)	Ultraviolet Absorbance at 254nm

ACKNOWLEDGMENTS

The Field Testing Organization, Gannett Fleming, Inc., was responsible for all elements in the testing sequence, including collection of samples, calibration and verification of instruments, data collection and analysis, data management, data interpretation and the preparation of this report.

Gannett Fleming, Inc.
P.O. Box 67100
Harrisburg, PA 17106-7100
Phone: 717-763-7211
Contact Person: Mr. Gene Koontz

The laboratory selected for microbiological analysis and non-microbiological, analytical work of this study was:

Pittsburgh Water and Sewer Authority
900 Freeport Road
Pittsburgh, PA 15238
Phone: 412-782-7552
Contact Person: Mr. Stanley States, Ph.D., Director of Analytical Services

The Manufacturer of the Equipment was:

The F.B. Leopold Co. Inc.
227 South Division Street
Zelienople, Pa 16063
Phone: 724-453-2095
Contact Person: Eugene Vegso, Senior Product Engineer, Membrane

Gannett Fleming wishes to thank the participants in this test, especially Bruce Bartley, Project Manager, Carol Becker and Kristie Wilhelm, Environmental Engineers, and Tina Beaugrand, Microbiology Laboratory Auditor of NSF International for providing guidance and program management.

The Pittsburgh Water and Sewer Authority staff including Dr. Stanley States, Director of Analytical Services, Raymond Wisloski, Water Treatment Plant Manager, Chester Grassi, Assistant Plant Manager, and Mickey Schuering, Water Treatment Technician provided invaluable analytical and operational assistance.

Eugene Vegso, Senior Product Engineer, Membrane, Tom Tyndall, Application Engineer, and Brian Bates, Field Process Engineer of Leopold Membrane Systems are to be commended for providing the treatment system and excellent technical and product expertise.

Chapter 1 Introduction

1.1 ETV Purpose and Program Operation

The U.S. Environmental Protection Agency (EPA) has created the Environmental Technology Verification (ETV) Program to facilitate the deployment of innovative or improved environmental technologies through performance verification and dissemination of information. The goal of the ETV program is to further environmental protection by substantially accelerating the acceptance and use of improved and more cost-effective technologies. ETV seeks to achieve this goal by providing high quality, peer reviewed data on technology performance to those involved in the design, distribution, permitting, purchase, and use of environmental technologies.

ETV works in partnership with recognized standards and testing organizations; stakeholders groups which consist of buyers, vendor organizations, and permittees; and with the full participation of individual technology developers. The program evaluates the performance of innovative technologies by developing test plans that are responsive to the needs of stakeholders, conducting field or laboratory (as appropriate), collecting and analyzing data, and preparing peer reviewed reports. All evaluations are conducted in accordance with rigorous quality assurance protocols to ensure that data of known and adequate quality are generated and that the results are defensible.

NSF International (NSF) in cooperation with the EPA operates the Package Drinking Water Treatment Systems (PDWTS) program, one of 12 technology areas under ETV. The PDWTS program evaluated the performance of The F.B. Leopold Company Inc.'s. (Leopold) Ultrabar Ultrafiltration System. The specific model tested utilized a 60 inch membrane element with a Mark III series flow configuration (Leopold Ultrabar Mark III Ultrafiltration System). The performance claim evaluated during field testing of the Leopold Ultrabar Mark III Ultrafiltration System was that the system is capable of a minimum 3 log₁₀ removal of Giardia cysts and 2 log₁₀ removal of Cryptosporidium oocysts. This document provides the verification test results for the Leopold Ultrabar Mark III Ultrafiltration System.

1.2 Testing Participants and Responsibilities

The ETV testing of the Leopold Ultrabar Mark III Ultrafiltration System was a cooperative effort between the following participants:

NSF International
Gannett Fleming, Inc.
Leopold Corporation
Pittsburgh Water and Sewer Authority
U.S. Environmental Protection Agency

The following is a brief description of each ETV participant and their roles and responsibilities.

1.2.1 NSF International

NSF is a not-for-profit testing and certification organization dedicated to public health safety and the protection of the environment. Founded in 1946 and located in Ann Arbor, Michigan, NSF has been instrumental in the development of consensus standards for the protection of public health and the environment. NSF also provides testing and certification services to ensure that products bearing the NSF Name, Logo and/or Mark meet those standards. The EPA partnered with the NSF to verify the performance of package drinking water treatment systems through the EPA's ETV Program.

NSF provided technical oversight of the verification testing. An audit of the field analytical and data gathering and recording procedures was conducted by NSF. NSF also provided review of the Field Operations Document (FOD) and this report.

Contact Information:

NSF International
789 N. Dixboro Rd.
Ann Arbor, MI 48105
Phone: 734-769-8010
Fax: 734-769-0109
Contact: Bruce Bartley, Project Manager
Email: bartley@nsf.org

1.2.2 Gannett Fleming, Inc.

Gannett Fleming, Inc., a consulting engineering firm, conducted the verification testing of the Leopold Ultrabar Mark III Ultrafiltration System. Gannett Fleming is a NSF-qualified Field Testing Organization (FTO) for the PDWTS ETV pilot project.

The FTO was responsible for conducting the verification testing for 30 calendar days. The FTO provided all needed logistical support, established a communications network, and scheduled and coordinated activities of all participants. The FTO was responsible for ensuring that the testing location and feed water conditions were such that the verification testing could meet its stated objectives. The FTO prepared the FOD, oversaw the pilot testing, managed, evaluated, interpreted and reported on the data generated by the testing, as well as evaluated and reported on the performance of the technology.

FTO employees conducted the onsite analyses and data recording during the testing. Oversight of the daily tests was provided by the FTO's Project Manager and Project Director.

Contact Information:

Gannett Fleming, Inc.
P.O. Box 67100
Harrisburg, PA 17106-7100
Phone: 717-763-7211
Fax: 717-763-1808

Contact: Gene Koontz, Project Director
Email: gkoontz@gfnet.com

1.2.3 Manufacturer

The system that underwent ETV testing was manufactured by Leushuis Projects and Engineering BV. The operating system is owned and operated by The F.B. Leopold Co. Inc. The F.B. Leopold Co. Inc specializes in providing treatment systems to the water industry.

The manufacturer was responsible for supplying a field-ready membrane filtration pilot plant equipped with all necessary components including treatment equipment, instrumentation and controls, and an operations and maintenance manual. The unit was capable of continuous, safe, 24 hour per day operation with minimal operator attention. The unit was equipped with protective devices to provide for automatic shut down of the pilot plant in the event of loss of feed water or any other condition that would either damage the pilot plant or render data generated by the unit to be unreliable. The pilot unit tested was constructed using metric parts. The manufacturer reports that subsequent pilot units have been constructed in the United States using English parts. The manufacturer was responsible for providing logistical and technical support as needed as well as providing technical assistance to the FTO during operation and monitoring of the equipment undergoing field verification testing.

Representatives of the manufacturer were utilized to conduct chemical clean in place (CIP), membrane integrity testing and examined daily operational data that were automatically recorded by the treatment system.

Contact Information:

The F.B. Leopold Co. Inc.
227 South Division Street
Zelienople, Pa 16063
Phone: 724-453-2095
Fax: 724-452-1377
Web Site: www.fbleopold.com
Contact Person: Eugene Vegso, Senior Product Engineer, Membrane
Email: gvegso@fbleopold.com

1.2.4 Host and Analytical Laboratory

The verification testing was hosted by the Pittsburgh Water and Sewer Authority (PWSA). PWSA serves water to over 500,000 people from its 120 million gallon per day (MGD) surface water treatment plant located in the Aspinwall section of the City of Pittsburgh. PWSA was interested in examining the use of membrane filtration to treat water which had been stored in its Highland Reservoir No. 1, an open finished water reservoir.

PWSA's laboratory provided collection and analytical services for Total Alkalinity, Total Hardness, Total Dissolved Solids (TDS), Total Suspended Solids (TSS), Total Coliforms, Heterotrophic Plate Count (HPC), Total Organic Carbon (TOC), Ultraviolet Absorbance at 254

nanometers (nm) (UVA₂₅₄), and Algae. In addition, PWSA supplied operational support and analytical services for the microbial removal testing. PWSA's laboratory is certified by the Pennsylvania Department of Environmental Protection (PADEP) for analysis of Microbiological, Inorganic, and Organic compounds in water. Additionally, the laboratory has received Protozoa Laboratory Approval from the EPA under the Information Collection Rule (ICR) Program. Copies of the Laboratory Approval Statements are attached in Appendix A.

Contact Information:

Pittsburgh Water and Sewer Authority
900 Freeport Road
Pittsburgh, PA 15238
Phone: 412-782-7552
Fax: 412-782-7564
Contact: Stanley States, Ph.D. Director of Analytical Services

1.2.5 U.S. Environmental Protection Agency

The EPA through its Office of Research and Development has financially supported and collaborated with NSF under Cooperative Agreement No. CR 824815. This verification effort was supported by the PDWTS Pilot operating under the ETV Program. This document has been peer reviewed and reviewed by NSF and EPA and recommended for public release.

1.3 Verification Testing Site

The verification testing was conducted at the PWSA's Highland Reservoir No. 1. The physical location of the treatment unit was the New Highland Pumping Station at the corner of North Negley Avenue and Mellon Terrace in the Highland Park section of the City of Pittsburgh, Pennsylvania. The treatment unit was in an enclosure located at the rear of the pumping station and received its feed water from the influent lines of the pumping station.

1.3.1 Source Water

The source water for the verification testing was finished drinking water that was stored in PWSA's open Highland Reservoir No. 1. The reservoir is 18 acres (ac) with an average depth of 20 feet (ft) and contains 120 million gallons (MG) of water. The water that is stored in Highland Reservoir No. 1 is treated surface water drawn from the Allegheny River. The water stored in the reservoir has undergone coagulation, sedimentation, filtration, and disinfection at PWSA's Aspinwall Treatment prior to being pumped to the reservoir. The influent to the Leopold Ultrabar Mark III Ultrafiltration System was drawn from the reservoir effluent lines. The effluent from the reservoir is not tested by PWSA and the Authority has little historical data regarding the quality of the reservoir water.

During the study, the feed water turbidity ranged from 0.06 to 0.13 Nephelometric Turbidity Units (NTU) with an average of 0.09 NTU. pH was within the range of 7.6 to 8.0 with an average of 7.8. Total alkalinity as calcium carbonate (CaCO₃) ranged from 35 to 43 mg/l with an average of 40 mg/l. Average hardness, as CaCO₃, was 94 mg/l and ranged from 90 to 100 mg/l. TOC

ranged from 1.57 to 2.20 mg/l with an average of 1.81 mg/l. UVA₂₅₄ was 0.018 cm⁻¹ on average, with a range of 0.016 to 0.022 cm⁻¹. TDS averaged 174 mg/l and the range was 148 to 214 mg/l. TSS averaged 0.095 mg/l and ranged from non detectable to 0.35 mg/l. HPC ranged from 28 to 188 colony forming units (cfu)/100 ml and averaged 111 cfu/100 ml. No coliform bacteria were detected in the feed water. Temperature averaged 3.9°C, ranging from 3.3°C to 4.5°C. The algae levels during the verification testing averaged 14 cells/ml, with a range of non detectable to 32 cells/ml. The above information is presented in Table 1-1 below.

Table 1-1. Leopold Ultrabar Mark III Ultrafiltration System Feed Water Quality

	Parameter									
	Total Alkalinity (mg/l as CaCO ₃)	Total Hardness (mg/l as CaCO ₃)	TDS (mg/l)	TSS (mg/l)	Total Coliforms (cfu/100 ml)	HPC (cfu/100 ml)	TOC (mg/l)	UVA (cm ⁻¹)	Algae (cells/ml)	Turbidity (NTU)
Average	40	94	174	0.095	0	111	1.81	0.018	14	0.09
Minimum	35	90	148	<0.05	0	28	1.57	0.016	<8	0.06
Maximum	43	100	214	0.35	0	188	2.20	0.022	32	0.13
Std. Dev.	3.1	4.1	26.5	0.14	0	71	0.242	0.0025	11	0.02
95% Confid Int	(37, 43)	(90, 97)	(151, 197)	(0, 0.22)	N/A	(48, 173)	(1.60, 2.02)	(0.015, 0.020)	(4, 23)	(0.08, 0.09)

N/A = Not Applicable because standard deviation = 0

Note: Calculated averages for less than results (<) utilize half of the Level of Detection (0.05 mg/l) or 0.025 mg/l in TSS calculations and 4 in Algae calculations. Per Statistical Methods for Environmental Pollution Monitoring, Richard O. Gilbert, Van Nostrand Reinhold, 1987.

1.3.2 Pilot Effluent Discharge

The effluent of the pilot treatment unit (i.e. the filtered water, backwash waste, and chemical cleaning waste) was piped to an existing catch basin that is part of the PWSA sanitary sewer collection system. No discharge permits were required.

Chapter 2 Equipment Description and Operating Processes

2.1 Equipment Description

The equipment tested in this ETV program was the Leopold Ultrabar Mark III Ultrafiltration System. The membrane used in the treatment system is a hollow fiber ultrafiltration membrane that is 0.030 inch (0.80 millimeters [mm] inside diameter) and 5.0 feet (1.5 meters [m] long). The membranes are made of modified polyethersulfone and have a nominal pore size of 0.01 micrometer (μm).

The membrane consists of hollow fibers, potted at both ends into an 8 inch diameter, 60 inch long element assembly. The element assemblies are contained in a reverse osmosis type 10 foot long housing. The housing is horizontally mounted on the treatment skid. The total filtration surface area provided by the two membrane elements is approximately 750 ft² (70 m²). The permeate is collected from the fibers into radial permeate collectors and are conveyed to a central permeate tube. The permeate is then conveyed to the permeate tank. The permeate tube and radial permeate collectors also allow for distribution of the backwash and cleaning solutions.

The fibers are fastened on both ends with an epoxy resin glued to the element assembly so there is no contact in between the raw water inside the fibers and the treated water (permeate) outside the fibers.

The raw water goes inside the lumen of each fiber. Due to the difference of pressure between the inside and the outside of the fibers, water is driven through the fibers. During filtration, the membrane retains the suspended solids, microorganisms and organic macromolecules forming a cake on the inner side of the ultrafiltration membrane. The process is called inside-out flow.

A summary of membrane characteristics as reported by the manufacturer is as follows:

Membrane classification.....	ultrafiltration (UF)
Membrane material	modified polyethersulfone
Membrane type	hollow fiber
Membrane flow path.....	inside out
Filtration mode	dead end
pH tolerance.....	3-10, (0-14 during cleaning)
Temperature tolerance	0 - 40° C (32 - 104° F)

The following major equipment components are provided on the Leopold Ultrabar Mark III Ultrafiltration System's self contained unit:

- One (1) feed water reservoir,
- One (1) feed pump,
- One (1) pre-filter,
- Two (2) Ultrabar ultrafiltration membranes,

- One (1) backwash pump,
- One (1) permeate tank,
- One (1) air compressor,
- One (1) sodium hypochlorite tank with one (1) metering pump,
- One (1) control panel.

A complete listing of the treatment system equipment can be found in the Operations and Maintenance (O&M) manual attached as Appendix B.

The following schematic (Figure 2-1) is a representation of the treatment system equipment, related names, and flow path.

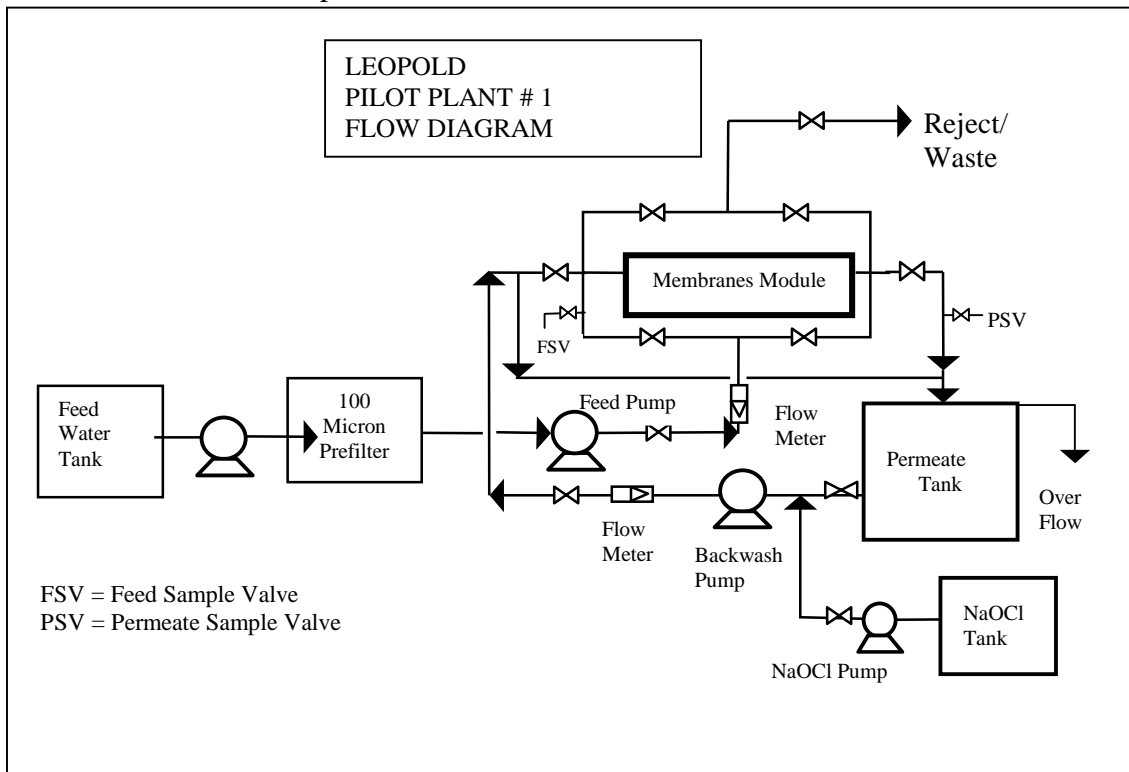
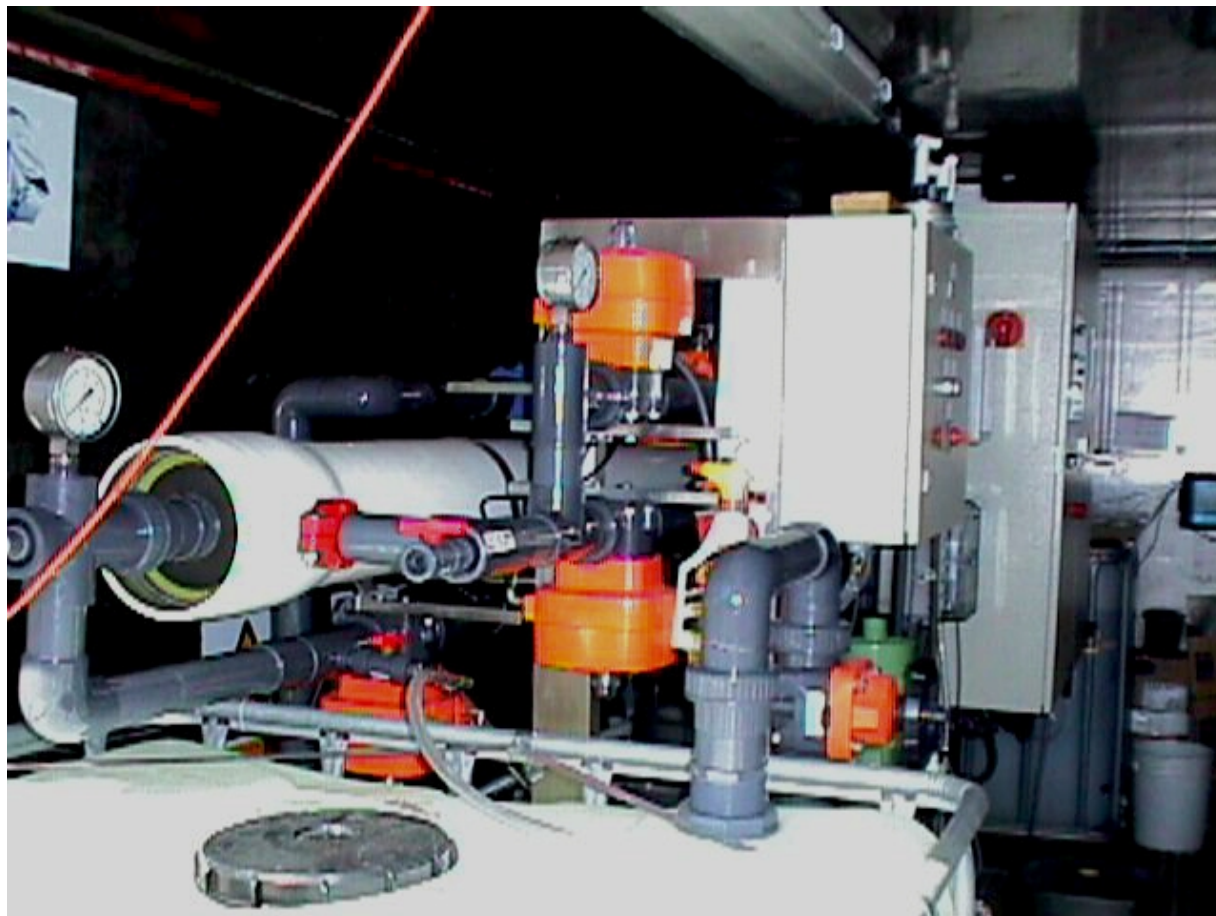

Figure 2-1. Flow schematic

The data plate affixed to the treatment system contains the following information.

- | | |
|--|--|
| <ul style="list-style-type: none"> a. Equipment name b. Model # c. Manufacturer's name and address d. Owner: e. Electrical requirements: f. Serial number g. Warning and caution statements h. Capacity or output rate | <ul style="list-style-type: none"> Membrane Pilot Plant DWG # 70025.2200.C Leushuis Projects and Engineering BV Opaalstreet 22-7554 TS Hengelo, The Netherlands The F.B. Leopold Company Inc. 460Volts, 3 phase, 30 amps, 60 Hz FBL-UB-001 N/A 10 to 60 gallons per minute (gpm) |
|--|--|

The following photograph was taken of the equipment while it was on site at PWSA's New Highland Pumping Station location during ETV testing.



Photograph 1. The Leopold Ultrabar Mark III Ultrafiltration System showing piping, membrane modules, and control panel.

2.2 Operating Process

2.2.1 Feed Water

The feed water is pumped into the filtration loop by the feed pump. The feed pump provides the pressure needed to drive the raw water through the fibers. In normal operation the feed flow is equal to the instantaneous production flow, ensuring a constant production rate.

2.2.2 Prefiltration

Prefiltration is performed with an automatically backwashed prefilter. A 100 micron (μm) metal screen backwashable prefilter removes large particles prior to the feed flow entering the modules. The prefilter protects the heads of the modules against clogging. Backwashing of the prefilter is done with unfiltered feed water. The timing of the prefilter backwash is independent of the backwashing of the membranes.

2.2.3 Filtration

The unit was operated in dead end filtration mode. In dead end filtration, raw water is pumped to the inside of the lumen of the fibers. The pressure from the feed pump drives the feed water through the lumen from inside to outside of the fiber producing the permeate.

The manufacturer reports that the maximum nominal pressure differential during the filtration cycle is 15 pounds per square inch (psi) (1.0 bar [b]).

2.2.4 Backwash/Reverse Flow

During normal operation, the Ultrabar unit alternates between the filtration mode and the backwash mode. These backwashes are initiated automatically. During the backwash cycle, permeate is sent back under pressure in the reverse direction to restore the effectiveness of the membrane. Only ultrafiltered water is used for backwash purposes. Normal backwashing flow is 80 gpm. A backwash pump, drawing water from the permeate tank, provides the water for backwash under pressure. For the backwash cycle, the nominal pressure differential is 23 psi (1.6 b). During the backwash, valves are operated to discharge the concentrate stream (backwash wastewater) to waste. Following backwash, the filtration cycle automatically resumes.

The backwash is automatically initiated after a preset filtration time. The frequency is dependent on raw water quality, and will occur between every 30 minutes to 60 minutes. For this verification study, a backwash frequency of 60 minutes was used due to the low amount of solids in the feed water. Raw water with higher solids loading will most likely require an increased backwash frequency. The backwash frequency was established by manufacturer after examination of the raw water quality and system performance during the initial operations period. Backwashing was sequenced via a program in the System Programmable Controller. After an appropriate time delay to ensure that all service valves are closed and the service pump has stopped, the backwash valves were opened and the Permeate (Backwash) Pump started and ran for 35 seconds. When the sequence was completed, the system returned to the service cycle after an appropriate period to ensure that the backwash sequence was completed and all the valves were closed and the pump had stopped. The entire backwash duration was 50 seconds in length.

2.2.5 Chemical Cleaning

For the purpose of this section, cleaning shall be noted as Backwashing, Chemically Enhanced Backwashing, and Chemical Cleaning using a chemical soak. The frequency of chemical cleaning is dictated by operational data and manufacturer recommendations. Generally, the unit is backwashed on a regular basis with “soak type cleaning” initiated due to a rise in Transmembrane Pressure (TMP) (from the starting point) of more than 10% (i.e. If starting at 20 psi feed, cleaning should be initiated when feed pressure is at 22 psi at the start of the service cycle after regular backwashing).

Backwashing:

Typically, backwashing is set at an interval of 60 minutes. Backwashing is sequenced via a program in the System Programmable Controller. After an appropriate time delay to

ensure that all service valves are closed and the service pump has stopped the Backwash valves open and the Permeate (Backwash) Pump starts and runs between 30 and 45 seconds. When the sequence is completed, the system returns to the service cycle after an appropriate period to ensure that the backwash sequence is complete, all the valves are closed, and the pump has stopped. For the test program the backwash waste was discharged to an existing catch basin.

Chemically Enhanced Backwashing:

Chemically Enhanced Backwashing is done on a periodic basis, as a prophylaxis against persistent fouling not purged during normal backwashing and to keep the system sanitary. The time period between this procedure is established during preliminary testing at site. The sequence for this procedure is similar to the regular backwash except approximately 200 mg/l of NaOCl (Sodium Hypochlorite) will be injected during the second half of the initial extended backwash. This is then followed by a period of soaking and followed by purging of the chemical via a permeate backwash. The time duration for this procedure will be:

1. 30 second backwash
 2. 45 second chemical injection backwash
 3. 5 minute soak period
 4. 45 second purge backwash
- Total time 7 minutes

Chemical Cleaning:

This procedure is used just prior to the start of the test and immediately after the completion of the testing. This procedure is identical to the procedure stated above except that the soaking period will be extended to 60 minutes.

Chapter 3 Methods and Procedures

3.1 Experimental Design

The experimental design of this verification study was developed to provide accurate information regarding the performance of the treatment system. The impact of field operations as they relate to data validity was minimized, as much as possible, through the use of standard sampling and analytical methodology. Due to the unpredictability of environmental conditions and mechanical equipment performance, this document should not be viewed in the same light as scientific research conducted in a controlled laboratory setting.

3.1.1 Objectives

The verification testing was undertaken to evaluate the performance of the Ultrabar Ultrafiltration System. Specifically evaluated were the manufacturer's stated equipment capabilities and equipment performance relative to water quality regulations. Also evaluated were operational and maintenance requirements of the system. The details of each of these evaluations are discussed below.

3.1.1.1 Evaluation of Stated Equipment Capabilities

The Ultrabar Ultrafiltration System was tested to show that it was capable of providing a minimum of 3 log₁₀ removal of *Giardia* cysts and a 2 log₁₀ removal of *Cryptosporidium* oocysts from the source water. The manufacturer states that the system was capable of consistently producing finished water with a turbidity of <0.1 NTU with a 95% confidence interval from feed water with turbidities up to 200 NTU. *Giardia* and *Cryptosporidium* challenge testing was conducted to demonstrate acceptable protozoan removal capability. Since turbidity challenge testing was not done during the course of the study and the turbidity of the feed water was quite low, turbidity removal capabilities were not verified during the course of the testing.

3.1.1.2 Evaluation of Equipment Performance Relative to Water Quality Regulations

Drinking water regulations require, for filtration plants treating surface water, a minimum of 3 log₁₀ removal/inactivation of *Giardia* cysts from feed to finished waters, that finished water turbidity at no time exceeds 5 NTU and that at least 95% of the daily finished water turbidity samples be less than 0.5 NTU (EPA, Surface Water Treatment Rule [SWTR], 1989). Recently promulgated rules have modified the SWTR to include a lower turbidity standard, less than 0.3 NTU in 95% of the daily finished water turbidity samples, and a requirement to provide a 2 log₁₀ removal of *Cryptosporidium* oocysts (EPA, Enhanced Surface Water Treatment Rule [ESWTR], 1999). Both these rules grant the "log removal credit" if the treatment facility achieves the required turbidity levels.

The treatment system's ability to achieve required finished water turbidity levels was not verifiable due to the fact that the feed water already was in compliance with drinking water turbidity regulations. Log removal for *Giardia* cysts and *Cryptosporidium* oocysts was

quantified using microbial removal challenge testing although there is no provision for this type of testing in the regulations.

3.1.1.3 Evaluation of Operational Requirements

An overall evaluation of the operational requirements for the treatment system was undertaken as part of the verification. This evaluation was qualitative in nature. The manufacturer's O&M manual (Operations & Maintenance Manual – Ultrabar Pilot #1. PCI/Leopold Membrane Systems, July, 1997) and experiences during the daily operation were used to develop a subjective judgement of the operational requirements of the system. The O&M Manual is attached to this report as Appendix B.

3.1.1.4 Evaluation of Maintenance Requirements

Verification testing also evaluated the maintenance requirements of the treatment system. Not all of the system's maintenance requirements were necessary due to the short duration of the testing cycle. The O&M manual details various maintenance activities and their frequencies (PCI, 1997). This information, as well as experience with common pieces of equipment (i.e. pumps, valves etc.) was used to evaluate the maintenance requirements of the treatment system.

3.1.2 *Equipment Characteristics*

The qualitative, quantitative and cost factors of the tested equipment were identified, in so far as possible, during the verification testing. The relatively short duration of the testing cycle creates difficulty in reliably identifying some of the qualitative, quantitative and cost factors.

3.1.2.1 Qualitative Factors

The qualitative factors examined during verification testing were susceptibility to changes in environmental conditions, operational reliability, and equipment safety.

3.1.2.2 Quantitative Factors

The quantitative factors examined during verification testing were power supply requirements, consumable requirements, waste disposal technique, and length of operating cycle.

3.1.2.3 Cost Factors

The cost factors examined during verification testing were power supply, consumables, and waste disposal. It is important to note that the figures discussed here are for the Leopold Ultrabar Mark III Ultrafiltration System. This treatment unit operated at 128 gallons per square foot per day (gfd) at 68 °F (216 liters per square meter per hour (l/m²/h) at 20°C). Costs will increase with increasing flow.

3.2 Water Quality Consideration

The focus of the ETV program is the verification that the tested treatment systems are capable of achieving their stated equipment capabilities. These capabilities invariably refer to the production of water meeting specific quality goals. In order to evaluate the effectiveness of the treatment system, it is necessary to know the objective of the study and the quality of the water before and after treatment.

The overall objective of the ETV program is to facilitate the deployment of innovative technologies through performance verification and information dissemination. Specifically, this ETV study was undertaken to demonstrate that the Leopold Ultrabar Mark III Ultrafiltration System was capable of providing a minimum 3 log₁₀ removal of *Giardia* cysts and 2 log₁₀ *Cryptosporidium* oocysts from source water to plant effluent.

3.2.1 Feed Water Quality

The source water for the verification testing of the Leopold Ultrabar Mark III Ultrafiltration System was from the open-air Highland Reservoir No. 1. The reservoir is 18 acres with an average depth of 20 feet (ft) and contains 120 million gallons (MG) of water. The water that is stored in Highland Reservoir No. 1 is treated surface water drawn from the Allegheny River. It has undergone coagulation, sedimentation, filtration, and disinfection at PWSA's Aspinwall Treatment Plant prior to being pumped to the Highland No. 1 reservoir. The influent to the treatment unit was drawn from the reservoir effluent lines. The effluent from the reservoir is not tested by PWSA and the Authority has little historical data regarding the quality of the reservoir water.

The parameters which were analyzed as part of the testing and the sampling frequency are presented in Table 3-1.

Parameter	Frequency	Feed	Permeate	Backwash Waste
Onsite Analytes				
Temperature	Daily	1	0	0
pH	Daily	1	0	0
Turbidity	Daily	2	Continuous	2
Particle Counts	Daily	Continuous	Continuous	0
Chlorine Residual	During Cleaning	1 (Backwash feed water)	0	1
Laboratory Analytes				
Total Alkalinity	Weekly	1	1	0
Total Hardness	Weekly	1	1	0
TDS	Weekly	1	1	0
TSS	Weekly	1	1	1
Total Coliforms	Weekly	1	1	1
HPC	Weekly	1	1	0
TOC	Weekly	1	1	0
UVA	Weekly	1	1	0
Algae	Weekly	1	1	0

3.2.2 Treated Water Quality

Characterization of the treated water quality was the driving force behind the development of the experimental design of the ETV. The water quality and microbial analyses which were conducted were selected to demonstrate the treatment effectiveness of the manufacturer's equipment. Treated water analyses and their frequencies are listed in Table 3-1 above.

In addition to analyses of total coliform and HPC, analyses for *Giardia* cysts and *Cryptosporidium* oocysts were conducted during the microbial removal phase of the evaluation. These analyses were conducted using procedures developed by EPA for use during the Information Collection Rule (ICR) for the identification and enumeration of *Giardia* cysts and *Cryptosporidium* oocysts (EPA, April 1996).

3.3 Recording Data

Operational and water quality data were recorded to document the results of the verification testing.

3.3.1 Operational Data

Operational data were read and recorded for each day of the testing cycle. The operational parameters and frequency of readings are listed in Table 3-2 below.

Parameter	Frequency
Raw flow	2/day
Feed water temperature	1/day
Electric power use	1/day
Influent module/vessel pressure	2/day
Effluent module/vessel pressure	2/day
Permeate pressure	2/day
Permeate flow	2/day

In addition to these parameters, data were collected during chemical cleaning and membrane integrity testing. Operational data collected during these tasks are discussed in Sections 3.8.2 and 3.8.5.

3.3.2 Water Quality Data

Table 3-1 lists the daily, weekly, and monthly water quality samples that were collected. The results of the daily on-site analyses were recorded in the operations log book. The weekly and monthly laboratory analyses were recorded in laboratory log books and reported to the FTO on separate laboratory report sheets. The data spreadsheets are attached to this report as Appendix C.

3.4 Communications, Logistics and Data Handling Protocol

With the number of verification participants involved in the study, it was important for the FTO to coordinate communication between all parties. Documentation of study events was facilitated through the use of logbooks, photographs, data sheets and chain of custody forms. Data handling is a critical component of any equipment evaluation or testing. Care in handling data assures that the results are accurate and verifiable. Accurate sample analysis is meaningless without verifying that the numbers are being entered into spreadsheets and reports accurately and that the results are statistically valid.

The data management system used in the verification testing program involved the use of computer spreadsheet software and manual recording methods for recording operational parameters for the membrane filtration equipment on a daily basis. Weekly and monthly water quality testing data were submitted to the FTO by PWSA Laboratory representatives, verified, and entered into computer spreadsheets.

3.4.1 Objectives

There were two primary objectives of the data handling portion of the study. One objective was to establish a viable structure for the recording and transmission of field testing data such that the FTO provides sufficient and reliable operational data for the NSF for verification purposes. A second objective was to develop a statistical analysis of the data, as described in "The Protocol for Equipment Verification Testing for Physical Removal of Microbiological and Particulate Contaminants" (EPA/NSF, April, 1998).

3.4.2 Procedures

The data handling procedures were used for all aspects of the verification test. Procedures existed for the use of the log books used for recording the operational data, the documentation of photographs taken during the study, the use of chains of custody forms, the gathering of on-line measurements, entry of data into the customized spreadsheets, and the methods for performing statistical analyses.

3.4.2.1 Log Books

Field logbooks were bound with numbered pages and labeled with project name. The log book is attached to this report as Appendix D. Logbooks were used to record equipment operating data. Each line of the page was dated and initialed by the individual responsible for the entries. Errors had one line drawn through them and the line was initialed and dated. Field testing operators recorded data and calculations by hand in laboratory notebooks. Daily measurements were recorded on specially prepared data log sheets. The laboratory notebook was photocopied weekly. The original notebooks were stored on-site; the photocopied sheets were stored at the office of the FTO. This procedure eased referencing the original data and offered protection of the original record of results. Treatment unit operating logs included a description of the membrane filtration equipment (description of test runs, names of visitors, description of any problems or issues, etc); such descriptions were provided in addition to experimental calculations and other items.

3.4.2.2 Chain of Custody

Samples which were collected by PWSA representatives and hand delivered to the laboratory were logged into the laboratory's sample record upon arrival at the laboratory. During an audit by NSF representatives, the use of chain of custody forms was requested. Subsequent samples were collected and hand delivered to the laboratory accompanied by chain of custody forms. The chain of custody forms are included in Appendix E.

3.4.2.3 Inline Measurements

Data from the computers recording the inline measurements were copied to disk at least on a weekly basis. This information was stored on site and at the FTO's office.

3.4.2.4 Spreadsheets

The database for the project was set up in the form of custom-designed spreadsheets. The spreadsheets are capable of storing and manipulating each monitored water quality and operational parameter from each task, each sampling location, and each sampling time. All data from the laboratory notebooks and data log sheets were entered into the appropriate spreadsheet. Data entry into the spreadsheets was conducted at the FTO's office by designated operators. All recorded calculations were also checked at this time. Following data entry, the spreadsheet was printed out and the printout was checked against the handwritten data sheet. Any corrections were noted on the hard copies and corrected on the screen, and then a corrected version of the spreadsheet was printed out. Each step of the verification process was initialed by the field testing operator or engineer performing the entry or verification step. Spreadsheet printouts are included in Appendix C of this report.

3.4.2.5 Statistical Analysis

Water quality data developed from grab samples collected during filter runs, the operational data recorded in the logbook, and the on-line data were analyzed for statistical uncertainty. The FTO calculated the average, minimum, maximum, standard deviation, and the 95% confidence intervals. The statistics developed are helpful in demonstrating the degree of reliability with which water treatment equipment can attain quality goals.

3.5 Recording Statistical Uncertainty

The FTO calculated a 95% confidence interval for selected water quality parameters. These calculations were also carried out on data from on-line monitors and for grab samples of turbidity, total alkalinity, total hardness, UVA₂₅₄, algae, total coliform, HPC, TOC, TSS, and TDS. The equation used is:

$$95\% \text{ confidence interval} = \bar{X} \pm t_{n-1,0.975} (S / \sqrt{n})$$

where: \bar{X} is the sample mean;

S is the sample standard deviation;

n is the number of independent measurements included in the data set; and

t is the Student's t distribution value with n-1 degrees of freedom;

Results of these calculations are expressed as the sample mean +/- the statistical variation.

3.6 Verification Testing Schedule

The verification testing commenced on February 4, 1999, with the initiation of daily testing. The unit ran in normal mode (dead end flow, 128 gfd at 68°F, [216 l/m²/h at 20°C] flux, 60-minute backwash interval). Daily testing concluded on March 9.

Giardia and *Cryptosporidium* removal challenge testing was conducted March 19, 1999. The cleaning efficiency task was performed on March 18. Membrane integrity testing was done on April 1.

3.7 Field Operations Procedures

In order to assure data validity, NSF Verification Testing Plan procedures were followed. This ensured the accurate documentation of both water quality and equipment performance. Strict adherence to these procedures resulted in verifiable performance of equipment.

3.7.1 Equipment Operations

The operating procedures used during the verification study were described in the Operations Manual (Appendix B) (PCI, 1997). Analytical procedures were described in equipment operations manual and PWSA's Laboratory Quality Assurance Plan (Appendix F) (PWSA, 1997).

3.7.1.1 Operations Manual

The Operations Manual for the treatment system was housed on-site, attached to the Field Operations Document, and attached to this report as Appendix B. Additionally, operating procedures and equipment descriptions were described in detail in Chapter 2 of this report.

3.7.1.2 Analytical Equipment

The following analytical equipment was used during the verification testing:

- A Fisher Accumet Model AP61 portable pH meter was used for pH analyses.
- A Hach 2100P portable turbidimeter was used for turbidity analyses.
- A Hach Pocket Colorimeter was used for chlorine analyses.
- An Ertco 1003-FC National Institute of Standards and Technology (NIST) traceable thermometer was used for temperature analyses. The thermometer had a range -1 to 51°C with scale divisions of 0.1°C.

The treatment unit used a Hach 1720D turbidimeter for permeate turbidity and Met One PCX particle counters for particle analysis.

3.7.2 Initial Operations

Initial operations allowed the equipment manufacturer to refine the unit's operating procedures and to make operational adjustments as needed to successfully treat the source water. Information gathered during system start up and optimization would have been used to refine the FOD, if necessary. No adjustment to the FOD was necessary as a result of the initial operations. The unit was on site in October 1998 and was operated for four months to establish the optimum treatment scheme prior to initiation of verification testing. The manufacturer replaced the membrane elements in the treatment unit on January 1, 1999 to a new type of element. The new element consisted the same hollow fiber membranes but utilized a different configuration for the radial permeate collectors and central permeate tube. The new element had been under development and testing during the initial operations period and the manufacturer felt that the new design offered advantages over the older model in permeate collection and in backwash distribution. For these reasons the decision was made by the manufacturer to conduct ETV testing on the new model membrane element. The designation of the new membrane element was Mark III; the old element was known as Mark II. As stated, the Mark III element was used during the verification testing.

The major operating parameters examined during initial operations were flux, transmembrane pressure, backwash frequency, and the efficiency of the treatment unit.

3.7.2.1 Flux

Production capacity of a membrane system is usually expressed as flux. Flux is the water flow rate through the membrane divided by the surface area of the membrane. Flux is calculated from the flow rate and membrane surface area and it is typically expressed as gfd or l/m²/h. The total surface area of the membrane elements used for the verification testing was 750 ft² (70 m²). It is customary to refer to flux normalized to 68°F or 20°C. Lower temperatures increase the viscosity of water and decrease the amount of permeate that can be produced from a given area. The formula used to calculate the system flux is:

$$\begin{aligned}\text{Flux (in l/m}^2\text{/h)} &= (\text{Flow (gpm)} * 3.785 \text{ l/gal} * 60 \text{ minutes/hour}) / \text{membrane area (m}^2\text{)} \\ \text{Flux (in gfd)} &= (\text{Flow (gpm)} * 1440 \text{ minute/day}) / \text{membrane area (ft}^2\text{)}\end{aligned}$$

A manufacturer supplied correction factor, which is calculated from the temperature of the feed water, was used to normalize the flux to 68°F (20°C). The formula used for the calculation is:

$$\text{Flux (normalized to 68°F (20°C))} = (1.027^{(20 - \text{Water temperature})}) * \text{Flux (at uncorrected water temperature)}$$

The feed pressure to the membrane is adjusted to maintain the selected flux. This usually results in an increase in feed pressure to maintain the selected flux. In order to take this change in feed pressure into account, a parameter known as specific flux can be calculated. Specific flux is calculated by dividing the flux of the system by the transmembrane pressure. The specific flux is expressed in gallons per foot per day per psi (gfd/psi at 68°F) or liters per hour per meter squared per bar at 20°C (l/m²/h/b at 20°C).

3.7.2.2 Transmembrane Pressure

The pressures of the feed water were recorded twice per day. The permeate pressure was recorded twice per day. The amount of pressure lost as the water is filtered through the membrane is referred to as TMP.

3.7.2.3 Backwash

Backwashing of the filter is accomplished by forcing permeate under pressure in the reverse direction through the hollow fiber membrane. This removes the particles that have been accumulated on the membrane and carries them to waste. The pilot automatically initiates a backwash after a preset filtration time. Membranes used on feed waters with low solids loading can operate with longer filtration cycles than those used on feed waters with higher solids loading. The filtration interval was set initially to accommodate the quality of the feed water. Adjustments to the backwash interval are made based on the maintenance of flux. That is, if the backwash is not able to maintain flux at a particular level, the frequency of backwashing is increased.

For this test program, a backwash interval of 50 seconds every 60 minutes was used. Actual backwash time of the membrane was 35 seconds, the other 15 seconds was for cessation of the filtration cycle, valve operation and restart of the system. This backwash scenario was proven to be appropriate for flux maintenance during the study. The unit used approximately 50 gallons of permeate to backwash the membranes each cycle.

The prefilter was backwashed on an independent timing separate from the backwashing of the membranes. Feed water was used to backwash the prefilter. The backwash was done every 12 hours and used approximately four gallons of feed water.

3.7.2.4 Treatment Unit Efficiency

In order to calculate the efficiency of the treatment system, the net production of the unit is divided by the total production of the unit. Multiplying the average flow rate by the filtration run time gives the total amount produced for the run. The net production is calculated by subtracting the amount of permeate required to backwash the system from the total amount produced. Dividing the net production by the total production and multiplying the result by 100 equals the percent efficiency of the system.

3.8 Verification Task Procedures

The procedures for each task of the verification testing were developed in accordance with the requirements in the EPA/NSF ETV Protocol (NSF, 1998). The Verification Tasks were as follows:

- Task 1 Membrane Flux and Operation
- Task 2 Cleaning Efficiency
- Task 3 Finished Water Quality
- Task 4 Reporting of Maximum Membrane Pore Size

- Task 5 Membrane Integrity Testing
- Task 6 Microbial Removal

Detailed descriptions of each task are provided in the following sections.

3.8.1 Task 1: Membrane Flux and Operation

Membrane flux and operational characteristics were identified in this task. The purpose of this evaluation was to quantify operational characteristics of the UF equipment. Information regarding this task was collected throughout the length of the 30-day verification study.

The objectives of this task were to:

1. Establish appropriate operational parameters;
2. Demonstrate the product water recovery achieved;
3. Monitor the rate of flux decline over extended operation; and
4. Monitor raw water quality.

Standard operating parameters for filtration, backwash, and chemical cleaning were established through the use of the manufacturer's O&M Manual and the initial operations of the treatment system. After establishment of these parameters, the unit was operated under those conditions. Operational data were collected according to the schedule presented in Table 3-2.

3.8.1.1 Filtration

The flux selected for the verification study was 128 gfd at 68°F (216 l/h/m² at 20°C). This rate was selected by the manufacturer after examination of the initial operating data. This rate corresponds to a flux of 130 l/m²/h (79 gfd) at the conditions tested (i.e. 3.9°C [39°F]). The treatment unit adjusted flow as necessary to maintain this flux.

3.8.1.2 Backwash

The filtration cycle was 60 minutes for the verification study. The backwash required 50 seconds to complete; 15 seconds for system shutdown and various valve operations and 35 seconds for the backwash itself.

The interval between backwashes is determined based on the maintenance of flux. That is, if the backwash frequency is not able to maintain flux at a particular level, it is increased. The backwash frequency used during the study was capable of maintaining the flux selected for the verification testing.

The procedure for backwashing is detailed in the O&M Manual and will not be presented here. The normal backwash is an automatic function of the unit; the only adjustments which can be made are to frequency, duration, and pressure. Procedures for making these adjustments are detailed in the O&M Manual (Appendix B).

3.8.1.3 Chemical Cleaning

Chemical cleaning was to be initiated due to a rise in TMP (from the starting point) of more than 10%. (i.e. If starting at a feed water pressure of 20 psi, cleaning should be initiated when feed pressure is at 22 psi at the start of the service cycle after regular backwashing). Due to the short duration of the verification testing and high quality of the feed water, chemical cleaning was not dictated by operational parameters; cleaning was conducted as per protocol requirements at the conclusion of the verification test.

The chemical cleaning procedure is similar to the regular backwash except approximately 200 mg/l of NaOCl (Sodium Hypochlorite) was injected during the second half of the initial extended backwash. This was then followed by a period of soaking and followed by purging of the chemical via a permeate backwash. The time duration for this procedure was:

1. 30 second backwash
2. 45 second chemical injection backwash
3. 60 minute soak period
4. 45 second purge backwash

Total time: 62 minutes

3.8.2 Task 2: Cleaning Efficiency

Cleaning efficiency procedures were identified in this task. The objectives of this task were to:

1. Evaluate the effectiveness of chemical cleaning for restoring finished water productivity to the membrane system.
2. Confirm manufacturer's cleaning practices are sufficient to restore membrane productivity.

Chemical cleaning was to be initiated due to a rise in TMP (from the starting point) of more than 10%. If chemical cleaning was not required during the testing, it was to be performed at the conclusion of the 30-day period. The membranes were cleaned using manufacturer's recommendations March 18, 1999.

Prior to cleaning, the treatment system was operated at the conditions as described in Section 3.8.1. Operational data, including flow and pressure, were collected prior to cleaning. After cleaning, the system was restarted and operated a sufficient period of time to establish post cleaning, specific rate of flux recovery. Operational data, including flow and pressure, were collected after cleaning. Table 3-3 details all the operational and analytical data collected before, during, and following cleaning.

Table 3-3. Analytical & Operational Data Collection Schedule - Chemical Cleaning

Parameter	Frequency
pH of cleaning solution initial	1/episode
pH of cleaning solution during process	1/episode
pH of cleaning solution final	1/episode
TDS of cleaning solution initial	1/episode
TDS of cleaning solution during process	1/episode
TDS of cleaning solution final	1/episode
Turbidity of cleaning solution initial	1/episode
Turbidity of cleaning solution during process	1/episode
Turbidity of cleaning solution final	1/episode
Oxidant residual initial	1/episode
Oxidant residual final	1/episode
Visual observation of backwash waste initial	1/episode
Visual observation of backwash waste final	1/episode
Flow of UF unit prior to cleaning	1/episode
Pressure of UF unit prior to cleaning	1/episode
Temperature of UF unit prior to cleaning	1/episode
Flow of UF unit after cleaning	1/episode
Pressure of UF unit after cleaning	1/episode
Temperature of UF unit after cleaning	1/episode

3.8.2.1 Cleaning Procedures

The procedure used to perform chemical cleaning is presented in the O&M Manual (Appendix B).

The cleaning procedure consists of introducing a reverse flow of permeate and backwashing the membrane. During the second half of an extended backwash 200 mg/l of NaOCl is added to the backwash water. The membranes are soaked in this solution for one hour. The resulting waste solution is then purged from the membrane, the membrane is rinsed, and returned to service.

3.8.3 Task 3: Finished Water Quality

Procedures for the collection and analysis of finished water quality samples are identified in this task. The purpose of this task was to demonstrate whether the manufacturer's stated treatment goals are attainable. The goal of this portion of the ETV was to demonstrate the treatment unit's ability to consistently produce water with a turbidity of less than 0.1 NTU and comply with current and future regulations in the SWTR and ESWTR as they apply to filtration. Since the feed water was consistently less than 0.1 NTU and a turbidity challenge was not conducted, this stated treatment goal was not verifiable.

Testing on finished water was conducted throughout the length of the 30-day run. Procedures for sample collection and analysis, analytical equipment operation, analytical equipment calibration and calibration results are discussed in Section 3.8.3.1.

3.8.3.1 Sample Collection and Analysis Procedure

Finished water samples were collected and analyzed weekly for total alkalinity, total hardness, and TDS. Weekly collection and analysis was also performed on finished water samples for

TSS, total coliforms, HPC, TOC, UVA₂₅₄, and algae. A summary of the sampling schedule is presented in Table 3-1.

Sample collection and analysis was performed according to procedures adapted from Standard Methods (APHA et al., 1992) and Methods for Chemical Analysis of Water and Wastes (EPA, March, 1979).

3.8.4 Task 4: Reporting of Maximum Membrane Pore Size

Determination of the maximum membrane pore size was to be done to assess a UF unit's ability to sieve particles of particular sizes. The FTO was to conduct a bubble point test, air pressure hold test, diffusive air flow test, or sonic wave sensing on the type of membrane in use during the verification study. The test was to be conducted by a state or EPA certified laboratory. Due to the extremely high cost of this test and the reliability of data available from membrane manufacturers, the ETV Steering Committee modified this requirement. The 1999 ETV Protocol Revision requires the reporting of the maximum membrane pore size by the manufacturer based on recommendation by the Steering Committee (EPA/NSF 1999).

The manufacturer requested a waiver to permit the reporting of maximum membrane pore size in lieu of maximum pore size determination. This waiver was granted based on the modified Protocol requirement (EPA/NSF 1999).

3.8.5 Task 5: Membrane Integrity Testing

Procedures for the testing of membrane integrity are identified in this task. The experimental objective of this task was to assess the membrane's integrity through the use of an air pressure hold test, turbidity reduction monitoring and particle count reduction monitoring. Membranes provide a physical barrier against the passage of particles and most types of microbial contamination. If the membrane is compromised, that is not intact, this barrier is lost. It is important to be able to detect when a membrane is compromised.

The three procedures, air pressure hold test, turbidity reduction monitoring, and particle count reduction monitoring, were conducted on intact and compromised membranes. The tests were conducted prior to and after the intentional breaking of a membrane hollow fiber.

3.8.5.1 Air Pressure Hold Test

In order to conduct this test, the membrane vessel with the intact membrane remained in the treatment unit and the permeate side was drained. The membrane itself was fully wetted (i.e. membrane pores were filled with water). The membrane was air pressurized up to 8.0 psi. The permeate side was sealed and the pressure decline rate was monitored, once every 30 seconds, using an air pressure gauge. An intact membrane would be demonstrated by minimal pressure loss, i.e. 2.0 psi every 5 minutes. Air pressure loss was also compared to the loss that was obtained when testing a compromised membrane.

3.8.5.2 Turbidity Reduction Monitoring

Turbidity of feed and permeate water was monitored. An intact membrane would be expected to show a 90% reduction in turbidity from feed to permeate. Due to the high quality of the feed water (the average feed turbidity was 0.09 NTU) showing a 90% reduction, 0.009 NTU, was beyond the capability of the turbidimeters. Since the use of percent reduction was not feasible a comparison of the turbidity of the permeate produced by an intact membrane to the turbidity of the permeate produced by a compromised membrane was made. An increase of 100% of the turbidity of the permeate produced with the intact membrane compared to the turbidity of the permeate produced with a compromised membrane was used as an indication of a compromised membrane.

3.8.5.3 Particle Count Reduction Monitoring

Particle count reductions from source to finished water of 99.9% would demonstrate an intact membrane. Due to the high quality of the feed water (the average cumulative feed water particle counts were 101 total counts per ml) showing a 99.9% reduction was pushing the limits of the instrumentation. Particle counts were monitored continuously and differences between permeate particle counts from an intact and a compromised membrane were compared. Since the use of percent reduction was not feasible a comparison of the particle counts of the permeate produced by an intact membrane to the particle counts of the permeate produced by a compromised membrane was made. An increase in total particle counts of 100% of the permeate produced with the intact membrane to the total particle counts of the permeate produced with a compromised membrane was used as an indication of a compromised membrane.

3.8.6 Task 6: Microbial Removal

The primary goal of water treatment is to provide water that is free of disease-causing organisms. Traditionally, most of these organisms are removed or rendered non-infectious through the use of conventional treatment practices like sedimentation, filtration, and disinfection. Not all disease-causing organisms are reliably removed by these conventional processes. Membrane filtration offers the advantage of providing a physical barrier against the passage of two of these organisms, *Giardia* and *Cryptosporidium*.

The purpose of this task was to demonstrate the treatment unit's ability to provide a minimum 3 log₁₀ removal from source water to plant effluent of *Giardia* cysts and 2 log₁₀ removal of *Cryptosporidium* oocysts. Participation in this task was optional. The manufacturer opted to participate in the microbial removal challenge.

Microbial challenge testing took place on March 19, 1999. The procedures for the preparation of the feed water stock, stock addition, sample collection and analysis, and calibration are presented below.

Procedures for the testing the effectiveness of treatment system in removing *Giardia* cysts and *Cryptosporidium* oocysts are identified in this section. The testing schedule, the experimental objectives, procedures, and data collection schedule are discussed below.

3.8.6.1 Feed Water Stock Preparation

Challenge organisms were concentrated stock suspensions of formalin-fixed *Giardia lamblia* cysts and formalin-fixed *Cryptosporidium parvum* oocysts. The suspensions were added to a reservoir using a pipette as that reservoir was being filled with 50 gallons of feed water. A cocktail of both protozoans was added to the same feed water reservoir and fed simultaneously to the treatment system. The concentration of the organisms was determined from the stock suspensions by replicate counts from loading multiple hemocytometers. Five two-ml samples were taken from the feed water reservoir. These samples were examined and the quantity of cysts and oocysts was determined. This was used as a check of the replicate hemocytometer counts.

3.8.6.2 Stock Addition Procedure

Source water concentrations were fed into the treatment system immediately before the membrane vessels over approximately 60 minutes. Seeding began immediately after a backwash cycle. The feed water stock reservoir was gently mixed during this process.

3.8.6.3 Sample Collection Procedure

After the suspension was prepared and before the initiation of filtration, samples were collected to establish the initial titer of the microorganisms. The feed suspension was pumped into the feed water line immediately before the membrane vessels. Once filtration had begun, the operational parameters, as presented in Table 3-2, were recorded. Daily analytical testing as presented in Table 3-1 was conducted. One thousand liters (264 gallons) of permeate water were then passed through a 1 μm nominal pore sized yarn wound filter at a rate of 3.785 liters per minute (lpm) (one gpm). Sample volumes of feed water, permeate water and back washwater were recorded. Samples were processed and analyzed by PWSA's EPA-qualified laboratory according to EPA protocols (EPA, April, 1996). A minimum of three replicates of the filtered water sample were analyzed.

3.9 QA/QC Procedures

Maintenance of strict Quality Assurance/Quality Control (QA/QC) procedures is important, in that if a question arises when analyzing or interpreting data collected for a given experiment, it will be possible to verify exact conditions at the time of testing. The following QA/QC procedures were used during the verification testing.

3.9.1 Daily QA/QC Verification Procedures

Daily QA/QC procedures were performed on the inline turbidimeter and inline particle counter flow rates and inline turbidimeter readout.

3.9.1.1 Inline Turbidimeter Flow Rate

The inline turbidimeter flow rate was verified volumetrically over a specific time. Effluent from the unit was collected into a graduated cylinder while being timed. Acceptable flow rates, as specified by the manufacturer, ranged from 250 ml/minute to 750 ml/minute. The target flow rate was 500 ml/minute. Adjustments to the flow rate were made by adjusting the valve controlling flow to the unit. Fine adjustments to the flow rate were difficult to make. If adjustments to the flow rate were made, they were noted in the operational/analytical data notebook by including the flow rate prior to adjustment in parenthesis next to the description of what adjustment was made.

3.9.1.2 Inline Particle Counter Flow Rate

The flow rates for the feed water and permeate inline particle counters were verified volumetrically over a specific time. Effluent from the units was collected into a graduated cylinder while being timed. Acceptable flow rates, as specified by the manufacturer, ranged from 90 ml/minute to 110 ml/minute. The target flow rate was 100 ml/minute. Care was taken to maintain the flow rate between 95 ml/minute and 105 ml/minute. Changes to the flow rate were made by adjusting the level of the discharge from the overflow weir. If adjustments to the flow rate were made, they were noted in the operational/analytical data notebook by including the flow rate prior to adjustment in parenthesis next to the description of what adjustment was made.

3.9.1.3 Inline Turbidimeter Readout

Inline turbidimeter readings were checked against a properly calibrated bench model. Samples of the permeate were collected and analyzed on a calibrated bench turbidimeter. The readout of the bench model and the inline turbidimeter were recorded. Exact agreement between the two turbidimeters is not likely due to the differences in the analytical techniques of the two instruments.

3.9.2 Bi-Weekly QA/QC Verification Procedures

Bi-weekly QA/QC procedures were performed on the inline flow meter. The meter was checked to determine if cleaning was necessary and verification of flow was performed.

3.9.2.1 Inline Flow Meter Clean Out

Examination of the inline flow meters indicated that clean out was not required during the verification testing. This was due to the short duration of the study and the high quality of the feed water.

3.9.2.2 Inline Flow Meter Flow Verification

Verification of the readout of the feed, permeate, and backwash flow meters was conducted bi-weekly during the testing period. This was done by taking the difference in the totalizer reading

over a specific period of time and comparing it to a volume collected over the same time period. The feed meter was verified by shutting off the feed water flow to the feed tank, drawing the tank down, measuring the amount of water drawn from the tank, and comparing it to the totalizer reading. The permeate meter was verified by dropping the level of the water in the permeate tank, allowing the tank to fill with permeate, measuring the amount of water that entered the tank, and comparing it to the totalizer reading.

3.9.3 Procedures for QA/QC Verifications at the Start of Each Testing Period

Verifications of the inline turbidimeter, pressure gauges/transmitters, tubing and particle counters were conducted. These verification procedures follow.

3.9.3.1 Inline Turbidimeter

The inline turbidimeter reservoir was cleaned by removing the plug from the bottom of the unit and allowing the body to drain. The body of the unit was then flushed with water. The unit was recalibrated following manufacturer's recommendations.

3.9.3.2 Pressure Gauges / Transmitters

Pressure gauge readouts were compared to the display on the control screen, although the readings taken directly from the gauges were entered into the operational/analytical data log book. Verification of the pressure gauge readings could not be accomplished. The treatment system was manufactured in Europe and the pressure gauge inlets were metric in size. The dead test meter's inlet was English size. The FTO was unable to locate an adapter to allow the gauges to be tested on the dead test meter. NSF was contacted and approved the use of calibrations that had been recently conducted on the pressure gauges by an independent laboratory.

3.9.3.3 Tubing

The tubing and connections associated with the treatment system were inspected to verify that they were clean and in good condition.

3.9.3.4 Inline Particle Counters

Calibration of the particle counter is generally performed by the instrument manufacturer. The calibration data was provided by the instrument manufacturer for entry into the software calibration program. Once the calibration data was entered, it was verified, by the FTO, using calibrated mono-sized polymer microspheres. Microspheres of 5 μ m, 10 μ m and 15 μ m were used for particle size verification. The following procedure was used for instrument calibration:

- Analyze the particle concentration in the dilution water;
- Add an aliquot of the microsphere solution to the dilution water to obtain a final particle concentration of 2,000 particles per ml;
- Analyze a suspension of each particle size separately to determine that the peak particle concentration coincides with the diameter of particles added to the dilution water;

- Prepare a cocktail containing all three microsphere solutions to obtain a final particle concentration of approximately 2,000 particles per ml of each particle size; and
- Analyze this cocktail to determine that the particle counter output contains peaks for all the particle sizes.

3.9.4 On-Site Analytical Methods

Procedures for daily calibration, duplicate analysis, and performance evaluation for pH, temperature, residual chlorine, and turbidity are discussed in the following sections.

3.9.4.1 pH

Analysis for pH was performed according to *Standard Methods* 4500-H⁺. A two-point calibration of the pH meter was performed each day the instrument was in use. Certified pH buffers in the expected range were used. After the calibration, a third buffer was used to check linearity. The values of the two buffers (pH 4 and pH 10) used for calibration, the efficiency of the probe (calculated from the values of the two buffers), and the value of the third buffer (pH 7) used as a check were recorded in the logbook.

pH measurements do not lend themselves to “blank” analyses. Duplicates were run once a day. Performance evaluation samples were analyzed during the testing period. Results of the duplicates and performance evaluation samples were recorded.

3.9.4.2 Temperature

Readings for temperature were conducted in accordance with *Standard Methods* 2550. Raw water temperatures were obtained once per day by submerging the thermometer in the feed water reservoir. A NIST certified thermometer having a range of – 1°C to +51°C, subdivided in 0.1°C increments, was used for all temperature readings.

Temperature measurements do not lend themselves to “blank” analyses. Duplicates were run on every sample. The temperature of the feed water was not recorded until two like readings were obtained, indicating that the thermometer had stabilized. Two equivalent readings were considered to be duplicate analyses.

3.9.4.3 Residual Chlorine Analysis

Chlorine residual analyses were taken on the backwash waste according to *Standard Methods* 4500 Cl G. The unit was received new (factory calibrated) and daily calibration was not necessary.

The backwash wastewater was collected, during backwash, twice per day. The entire amount of wash water from a backwash was collected in a reservoir for analysis.

Blanks for chlorine analyses were done by analyzing deionized (DI) water daily. Duplicates were run once a day. Performance evaluation samples were analyzed during the testing period. Results of the duplicates and performance evaluation samples were recorded.

3.9.4.4 Turbidity Analysis

Turbidity analyses were performed according to *Standard Methods* 2130. The bench-top turbidimeter was calibrated at the beginning of verification test and on a weekly basis using primary turbidity standards according to manufacturer's recommendations. Primary turbidity standards of 0.1, 0.5 and 5.0 NTU were checked after calibration to verify instrument performance. Deviation of more than 10% of the true value of the primary standards indicated that recalibration or corrective action should be undertaken on the turbidimeter. Secondary standards were used on a daily basis to verify calibration.

Blanks for turbidity analyses were done by analyzing deionized (DI) water daily. Duplicates were run on feed water turbidity and backwash waste once a day. Performance evaluation samples were analyzed during the testing period. Results of the duplicates and performance evaluation samples were recorded.

3.9.5 Chemical and Biological Samples Shipped Off-Site for Analyses

PWSA's in-house laboratory was used for the analysis of chemical and biological parameters. PWSA's QA Plan outlines sample collection and preservation methods (PWSA, 1997) (Appendix F). Sample collection was done by representatives of PWSA.

3.9.5.1 Organic Parameters

Organic parameters analyzed during the verification testing were TOC and UVA₂₅₄.

Samples for analysis of TOC and UVA₂₅₄ were collected in glass bottles supplied by the PWSA laboratory and hand carried to the laboratory by a PWSA representative immediately after collection. TOC and UVA₂₅₄ samples were collected, preserved, and held in accordance with *Standard Method* 5010B. Storage time before analysis was minimized in accordance to *Standard Methods*.

Analyses of the TOC samples were done according to methodology outlined in PWSA's QA Plan which is based on *Standard Methods* 5310 C. Analyses of the UVA₂₅₄ samples were done according to methodology outlined in PWSA's QA Plan which is based on *Standard Methods* 5910 B.

3.9.5.2 Microbiological Parameters

Microbiological parameters analyzed during the verification testing were Total Coliform, HPC, protozoa, and algae.

Microbiological samples were collected according to procedures outlined in PWSA's QA Plan and hand delivered to the laboratory by a PWSA representative immediately following collection.

Samples were processed for analysis by the PWSA laboratory within the time specified for the relevant analytical method. The laboratory kept the samples refrigerated at 1-5° C until initiation of analysis.

Algae samples were preserved with Lugol's solution after collection and stored at a temperature of approximately 1-5° C until counted.

Algae samples were analyzed according to *Standard Method* 10200 F. Total coliforms were analyzed using procedures presented in PWSA's QA Plan. These procedures are based on *Standard Methods* 9222B. HPC analyses were conducted according to procedures presented in PWSA's QA plan. These procedures are based on *Standard Methods* 9215D. Protozoans were analyzed using procedures developed by EPA for use during the Information Collection Rule (EPA, 1996).

3.9.5.3 Inorganic Parameters

Inorganic parameters analyzed during the verification testing were Total Alkalinity, Total Hardness, TDS, and TSS.

Inorganic chemical samples were collected, preserved and held in accordance with *Standard Methods* 3010B. Particular attention was paid to the sources of contamination as outlined in *Standard Method* 3010C. The samples were hand delivered to the laboratory by a representative of PWSA immediately following collection. The laboratory kept the samples at approximately 1-5° C until initiation of analysis.

Total alkalinity analyses were conducted according to Method 150.1 (EPA, 1979). Total Hardness analyses were conducted according to Method 130.2 (EPA, 1979). TDS analyses were conducted according to *Standard Methods* 2540C. TSS analyses were conducted according to *Standard Methods* 2540D.

Chapter 4 Results and Discussions

4.1 Introduction

The verification testing for the Leopold Ultrabar Mark III Ultrafiltration System owned and operated by Leopold Membrane Systems which occurred at the PWSA's Highland No. 1 Reservoir in Pittsburgh, Pennsylvania commenced on February 4, 1999 and concluded its 30-day period on March 9. *Giardia* and *Cryptosporidium* removal challenge testing was conducted March 19, the cleaning efficiency task was performed on March 18, and membrane integrity testing was done on April 1.

This section of the verification report presents the results of the testing and offers a discussion of the results. Results and discussions of initial operations, equipment characteristics, membrane flux and operation, cleaning efficiency, finished water quality, maximum membrane pore size, membrane integrity testing, and microbial removal are presented. Also the results of the daily, bi-weekly and initial QA/QC procedures are presented in this section.

4.2 Initial Operations Period Results

An initial operations period allowed the equipment manufacturer to refine the unit's operating procedures and to make operational adjustments as needed to successfully treat the source water. The primary goals of the initial operations were to establish a flux rate, the expected transmembrane pressure, backwash frequency appropriate for the feed water quality, and the efficiency of the unit. The unit was on site in October 1998 until the end of the ETV testing and was operated for four months to establish the optimum treatment scheme prior to initiation of verification testing. The manufacturer replaced the membrane elements in the treatment unit January 1, 1999 to a new type of element. The new element consisted of the same hollow fiber membranes but utilized a different configuration for the radial permeate collectors and central permeate tube. The new element had been under development and testing during the initial operations period and the manufacturer felt that the new design offered advantages over the older model in permeate collection and in backwash distribution. For these reasons the decision was made by the manufacturer to conduct ETV testing on the new model membrane element. The designation of the new membrane element was Mark III; the old element was known as Mark II. As stated, the Mark III element was used during the verification testing.

4.2.1 Flux

The flux was gradually increased from 91 gfd to 132 gfd 68°F (155 l/m²/h to 224 l/m²/h at 20°C) during the initial operations period. Based on the data collected during the initial operations period, the manufacturer determined that the treatment unit would be capable of operating at 128 gfd at 68°F (216 l/m²/h at 20°C). This corresponded to an initial specific flux of 13 gfd/psi at 68°F (316 l/m²/h/b at 20°C).

4.2.2 Transmembrane Pressure

The TMP during the initial operations period varied with the flux. TMP ranged from 6.0 psi to 10 psi (0.41 b to 0.70 b) during the initial operations period.

4.2.3 Backwash Frequency

During the initial operations period, backwash frequencies of 45 and 60 minutes were investigated. Based on the results of the initial operations period, it was determined that a backwash interval of 50 seconds every 60 minutes would be used during the verification testing.

Actual backwash time of the membrane was 35 seconds; the other 15 seconds was for cessation of the filtration cycle, valve operation and restart of the system. This backwash scenario proved to be appropriate for flux maintenance during the study. The unit used approximately 50 gallons of permeate to backwash the membranes each cycle.

4.3 Verification Testing Results and Discussion

The results and discussions of membrane flux and operation, cleaning efficiency, finished water quality, reporting of maximum membrane pore size, membrane integrity testing, and microbial removal tasks of the verification testing are presented below.

4.3.1 Task 1: Membrane Flux and Operation

The parameters of flow, feed and permeate pressures, backwash frequency and volumes, and the feed water temperature were used to establish membrane flux and operational characteristics. TMP and rate of specific flux decline were established from these parameters. The results of the TMP and rate of specific flux decline are presented below. Date of chemical cleaning was March 18, 1999. A calculation of the treatment unit efficiency is presented.

4.3.1.1 Transmembrane Pressure Results

Transmembrane pressure fluctuated from 0.53 b to 0.81 b (7.7 psi to 12 psi). The average TMP during the testing was 0.68 b (9.8 psi). Table 4-1 presents a summary of the daily unit pressure readings and TMP. Figure 4-1 presents a graph of daily TMP results. A complete tabular summary of the data is presented in Appendix C.

	Feed Pressure (psi)	Permeate Pressure (psi)	Transmembrane Pressure (psi)
Average	18.9	9.1	9.8
Minimum	16.1	8.0	7.7
Maximum	22.6	10.9	11.7
Standard Deviation	1.58	0.79	0.95
95% Confidence Interval	(18.5, 19.3)	(8.9, 9.3)	(9.6, 10.1)

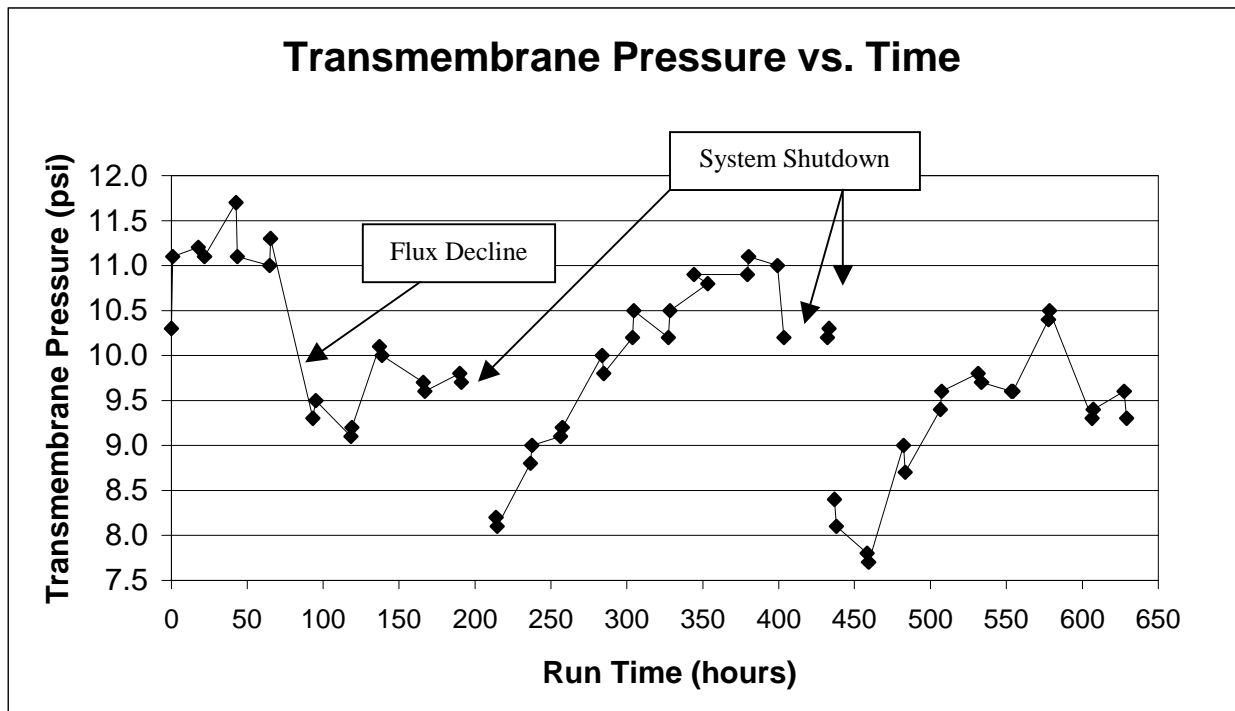

Figure 4-1. Transmembrane Pressure vs. Time

As depicted in Figure 4-1, the TMP was somewhat erratic during the verification testing. Due to a number of system shutdowns, the causes of which are discussed in Section 4.4.2.1, the membranes were allowed to relax during the testing. Specifically, system shutdowns occurred between run time hours 191 to 214, 403 to 432, and 433 to 437. This relaxation caused the TMP to decline at the restart of the system. The manufacturer reports that in their experience of piloting membrane systems a substantial recovery in TMP is typically witnessed when the membranes have been allowed to “relax” for a couple of days after a slow increase in TMP during steady state service.

Generally, the TMP increased during the continuous runs. The increase was not unexpected and seemed to indicate that the treatment system was capable of operation at the selected flux and backwash protocol on this feed water.

The increase in TMP during continuous runs may be due to the accumulation of particles on the membrane surface. The backwash protocol may not have removed all of the particulate material from the membrane. Another possibility is that there was some accumulation of algae or bacteria on the membrane. An accumulation of material on the membrane would, most likely, cause an increase in TMP in the system by limiting the available membrane surface area.

The TMP fluctuated somewhat from day to day with subsequent day’s readings sometimes being lower than the previous day’s results. This would seem to argue against the accumulation of material on the membrane. But examination of the overall TMP trend during continuous runs clearly shows an increase with time. The explanation of why TMP sometimes decreased from day to day may be due to the fact that the operational readings were taken at various times in the

operational cycle. The feed pressure increased as the time to the next backwash decreased. If the pressure and flow readings were taken shortly after the completion of a backwash cycle, a lower TMP would result. Likewise, if the readings were taken just prior to the initiation of a backwash cycle, a higher TMP would result.

The drop in TMP between run time 65 hours to run time 93 hours was caused by a drop in flux from 147 gfd at 68°F to 121 gfd at 68°F (249 l/m²/h 20°C to 205 l/m²/h 20°C).

Overall, the increase in TMP during the 30-day testing period was slight. This would seem to indicate that the selected flux and backwash protocol was appropriate for this feed water quality.

4.3.1.2 Specific Flux Results

The specific flux of the treatment system was 13 gfd/psi at 68°F (322 l/m²/h/b at 20°C) on average. The specific flux varied from a minimum of 11 gfd/psi at 68°F to 17 gfd/psi at 68°F (267 l/m²/h/b at 20°C to 417 l/m²/h/b at 20°C) during the testing. Table 4-2 presents a summary of the specific flux of the treatment system. Figure 4-2 presents a graph of daily specific flux results.

Table 4-2. Specific Flux

	Specific Flux (gfd/psi @68°F)
Average	13
Minimum	11
Maximum	17
Standard Deviation	1.3
Confidence Interval	(13, 13)

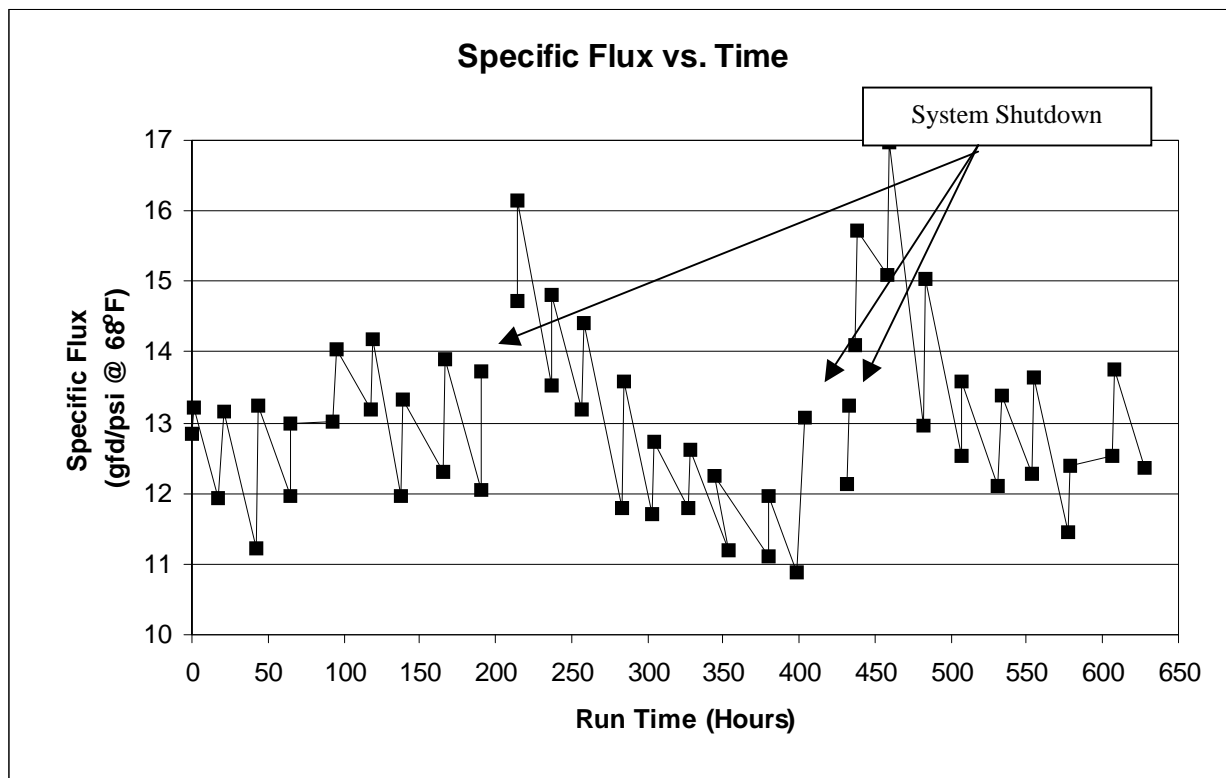

Figure 4-2. Specific Flux Decline vs. Time

As depicted in Figure 4-2, specific flux was somewhat erratic during the verification testing. This was similar to the results of the system TMP and was likely due to the system shutdowns discussed in Section 4.4.1.2 allowing the membranes to relax. The specific flux is a function of the flux and the TMP of the system. As the TMP of the system increases, the specific flux declines. The specific flux decline did not appear to be excessive during the testing. During the continuous runs, the specific flux declined. This was caused by the increase of TMP during the continuous runs. The erratic results from run time 0 hours to run time 190 hours were caused by slight changes in system flux and TMP.

4.3.1.3 Cleaning Episodes

Leopold recommends that cleaning be instituted due to a rise in TMP (from the starting point) of more than 10%. Due to the short duration of the verification testing and high quality of the feedwater, chemical cleaning was not dictated by operational parameters. Cleaning was conducted as per ETV protocol requirements on March 18, 1999. Results of that cleaning are presented in Section 4.3.2.

4.3.1.4 Percent Feed Water Recovery

The percent efficiency of the treatment system was calculated by comparing the net production to the total water filtered. The following equation was used:

$$\text{Percent feed water recovery} = 100 * [Q_p / Q_f]$$

Where: Q_p = permeate flow
 Q_f = feed flow to membrane

Using the above equation the following calculation was performed:

Permeate flow = flow (gpm) * minutes/day = permeate flow (gpd)

Permeate flow = 41.12 gpm * 1440 minute/day = 59213 gpd

Feed flow to membrane = permeate flow + backwash volume

Feed flow = 59213 + 50 gal/bw/hr*24hr/day = 60413 gpd

Percent feed water recovery = 100 * [59213/60413] = 98%

4.3.2 Task 2: Cleaning Efficiency

Cleaning was conducted on March 18, 1999. The cleaning process is a modification of the backwashing procedure. Chemically cleaning consists of reversing the flow of the permeate through the membrane fibers. Approximately 200 mg/l of NaOCl (Sodium Hypochlorite) was injected to the permeate. The membranes are then soaked in this solution for 60 minutes. The system is then purged of the solution via a permeate backwash. A detailed description of the cleaning process is presented in the manufacturer's O&M Manual (Appendix B).

Data on the characteristics of the cleaning solution before, during, and after cleaning were collected. Operational parameters were recorded before and after cleaning. The cleaning solution data were used to characterize the cleaning solution and waste generated by cleaning of

the membranes. The operational data were collected to facilitate the calculation of the recovery of specific flux and the loss of original specific flux.

4.3.2.1 Results of Cleaning Episodes

Table 4-3 below presents the chemical and physical characteristics of the cleaning solution. Table 4-4 presents the results of the operational parameters collected before, during, and after the cleaning procedure.

Table 4-3. Chemical and Physical Characteristics of Cleaning Solution

Parameter	Unit	Result	Dup.
pH of Cleaning Solution Initial		9.2	9.2
pH of Cleaning Solution During Process		8.8	8.9
pH of Cleaning Solution Final		9.1	9.0
TDS of Cleaning Solution Initial	(mg/l)	568	
TDS of Cleaning Solution During Process	(mg/l)	527	
TDS of Cleaning Solution Final	(mg/l)	512	
Turbidity of Cleaning Solution Initial	(NTU)	0.22	0.18
Turbidity of Cleaning Solution During Process	(NTU)	0.44	0.37
Turbidity of Cleaning Solution Final	(NTU)	23.1	21.5
Oxidant Residual Initial	(mg/l)	173	171
Oxidant Residual Final	(mg/l)	114	119
Visual Observation of Backwash Waste Initial		Tinted brown	
Visual Observation of Backwash Waste Final		Dark brown	

Table 4-4. Operational Parameter Results - Cleaning Procedure

Parameter	Unit	Time	Result
Flow of UF Unit Prior to Cleaning	(gpm)	9:05	39.90
Pressure of UF Unit Prior to Cleaning (Upper)	(psi)	9:05	16.9
Pressure of UF Unit Prior to Cleaning (Permeate)	(psi)	9:05	8.7
Temperature of UF Unit Prior to Cleaning	(°C)	9:05	4.4
Flow of UF Unit After Cleaning	(gpm)	12:15	40.04
Pressure of UF Unit After Cleaning (Upper)	(psi)	12:15	15.9
Pressure of UF Unit After Cleaning (Permeate)	(psi)	12:15	8.6
Temperature of UF Unit After Cleaning	(°C)	12:15	4.4

4.3.2.2 Calculation of Recovery of Specific Flux and Loss of Original Specific Flux

The following equation was used to calculate the recovery of specific flux:

$$\text{Recovery of specific flux} = 100 * (1 - (J_{s_f} / J_{s_i}))$$

Where: J_{s_f} = Specific flux (l/m²/h/b) at end of current run (final)

J_{s_i} = Specific flux (l/m²/h/b) when the system was restarted after completion of the cleaning procedure (initial)

The specific flux prior to the start of the cleaning process was 350 l/m²/h/b at 20°C (14 gfd at 68°F). The specific flux when the system was restarted after the completion of the washing procedure was 390 l/m²/h/b at 20°C (16 gfd at 68°F).

Using these figures in the above equation resulted in a recovery of specific flux of 11 %.

The following equation was used calculate the loss of original specific flux:

Loss of original specific flux = $100 * (1 - (J_{s_i} / J_{s_{i_0}}))$

where: $J_{s_{i_0}}$ = Specific flux ($l/m^2/h/b$) at time zero point of membrane testing

The specific flux at time zero point of membrane testing was $390 l/m^2/h/b$ at $20^\circ C$ ($16 gfd$ at $68^\circ F$). The specific flux when the system was restarted after the completion of the washing procedure was $390 l/m^2/h/b$ at $20^\circ C$ ($16 gfd$ at $68^\circ F$).

Using these figures in the above equation resulted in a loss of original specific flux of 0.43% .

4.3.2.3 Discussion of Results

Leopold recommends that cleaning be instituted due to a rise in TMP (from the starting point) of more than 10% . Due to the short duration of the verification testing and high quality of the feed water, chemical cleaning was not dictated by operational parameters. Cleaning was conducted as per ETV protocol requirements on March 18, 1999.

The procedure used for chemical cleaning was well defined in the operations manual and required minor manual effort. Assuring that enough NaOCl was in the chlorine feed tank for the cleaning procedure and initiating the cleaning procedure required approximately two hours of effort by the operator.

The characterization of the cleaning wastewater indicated that the solution was moderately basic, with a pH of 9.1 , a turbidity of $23 NTU$, a TDS of $512 mg/l$, and total chlorine residuals $116 mg/l$. The wastewater was dark brown in color. The color would indicate that some material was being removed from the membrane.

The cleaning solutions are a mixture of NaOCl and permeate. Care must be taken when handling 12.5% NaOCl to avoid injury. The cleaning solution is not a hazardous material. The presence of hazardous materials in the wastewater would be dependent on the quality of the feed water. Depending on local regulations, the waste stream may be able to be discharged to the sanitary sewer system.

Examination of the operational data and the recovery of specific flux showed that the cleaning procedure did restore 11% of the specific flux to the treatment system. This is a relatively low amount and may indicate that the cleaning procedure was not capable of restoring membrane performance or that this particular cleaning event was not effective. However, it may be a function of the fact that the system was not experiencing a significant loss of specific flux before cleaning was initiated.

Using these figures in the above equation resulted in a loss of original specific flux of 0.43% . This would indicate that the cleaning restored the membrane capacity to the capacity it had when it was placed into service. As previously mentioned, the membrane used in the verification testing was placed into service less than one month prior to the beginning of the testing and also was not experiencing a significant loss of flux when the cleaning was conducted. These facts may indicate that the recovery of original specific flux is not due so much to the effectiveness of the cleaning as to the relative age and condition of the membrane prior to cleaning.

4.3.3 Task 3: Finished Water Quality

Results of testing for turbidity in the feed and finished water were examined to verify the stated turbidity treatment ability. Since the feed water turbidity was consistently less than 0.1 NTU and a turbidity challenge was not conducted this stated treatment goal was not verifiable. A graph depicting daily log₁₀ removals for cumulative particle counts will be presented. Bacteria and algae removal results were examined. Examination of TOC and UVA₂₅₄ testing results, as well as testing results for the inorganic parameters total alkalinity, total hardness, TDS, and TSS was conducted. A TSS mass balance calculation will be presented. Graphs of four-hour readings for turbidity and particle count results will be shown.

4.3.3.1 Turbidity Results and Removal

Results of testing for turbidity in the feed and finished water were examined. The permeate results were from readings taken from the bench top turbidimeter. The inline permeate turbidimeter did not appear to be operating reliably throughout the verification testing frequently displaying readings which appeared to be erroneously high. Some results were four to five times greater than the feed water turbidity. The daily readings from the inline permeate turbidimeter averaged 0.08 NTU. This seemed to be due to an accumulation of air bubbles inside the turbidimeter body. After draining the turbidimeter body the readings would return for a short period of time to within the range of 0.02 to 0.03 NTU. For this reason, the turbidimeter was drained daily the last 10 days of the verification testing. At no time was any debris observed in the turbidimeter body. Given this apparent analytical aberration, the FTO is reporting the results from the permeate turbidity results from the bench top turbidimeter. The four hour permeate turbidity results were taken from the inline turbidimeter and do not appear to be reliable. For this reason the results of the inline permeate turbidity results are not presented. A summary of the bench top turbidimeter results is presented in Table 4-5.

Table 4-5. Turbidity Analyses Results and Removal – Bench Top Turbidimeter

Sample Parameter	Feed	Permeate	Amount Removed
	Turbidity (NTU)	Turbidity (NTU)	
Average	0.09	0.05	0.04
Minimum	0.06	0.04	0.00
Maximum	0.13	0.10	0.08
Std Dev	0.02	0.01	0.02
95% Confid Intl	(0.08, 0.09)	(0.04, 0.05)	(0.03, 0.05)

The turbidity of the permeate was very low throughout the duration of the verification testing. The benchtop turbidimeter readings averaged 0.05 NTU. Again, the inline permeate turbidimeter did not appear to be operating reliably throughout the verification testing and the results from the inline turbidimeter are not presented.

The turbidity removal of the system averaged only 0.04 NTU. The high quality of the feed water precluded high removals of turbidity.

4.3.3.2 Particle Count Results and Removal

Particle count readings in both feed water and permeate were taken on a continuous basis and recorded every 15 minutes. Average particle readings were taken from these 15 minute readings. The feed water cumulative counts averaged 100 particles per ml. The finished water cumulative counts averaged 3.3 counts per ml. The average \log_{10} removal for the cumulative counts was 1.5.

The low particle counts for each size range in the permeate water indicated good system performance throughout the testing period. The treatment system seems to be an effective removal mechanism for particle removal. The manufacturer expressed concern that the air bubbles that were effecting the inline permeate turbidimeter may have caused the permeate particle counts to be higher than actual. While this may have occurred, there is no evidence on this. Air bubbles were not observed accumulating in the particle counter sensor or sample lines.

Average feed water particle counts are presented in Table 4-6. Average finished water particle counts are presented in Table 4-7. Daily average cumulative counts for feed and finished water and the \log_{10} removal are presented in Table 4-8. A complete data table is presented in Appendix C. Figures 4-3 and 4-4 depict results of four hour particle counts for feed water and permeate. Figure 4-5 shows the results of the daily average \log_{10} cumulative particle removal calculations. Due to three interruptions of the system, \log_{10} removal data is not available for a number of days during the testing. See section 4.4.1.2 for information regarding the treatment system interruptions.

Table 4-6. Feed Water Particle Counts

	Size						Cumulative
	2-3 μ m	3-5 μ m	5-7 μ m	7-10 μ m	10-15 μ m	>15 μ m	
Average	40	44	8.2	6.9	2.1	0	100
Minimum	0	0	0	0	0	0	N/A
Maximum	480	670	190	260	160	0	N/A
Std. Dev.	21	28	5.8	5.3	2.8	0	N/A
Confidence Interval	(39, 41)	(43, 45)	(8.0, 8.3)	(6.7, 7.0)	(2.0, 2.2)	N/A ¹	N/A

N/A = Not Applicable. Statistical measurements on cumulative data do not generate meaningful data.

N/A¹ = Not Applicable because standard deviation = 0

Note: Due to results obtained during the QA/QC task involving verification of the calibration of the particle counters, the above readings for the feed water particle counts from 2-7 μ m should be increased by 26% to account for the low response of the feed water particle counts. Due to extremely low results obtained during the QA/QC task involving verification of the calibration of the particle counters, the above readings for the feed water particle counts from the 10 μ m size range the reliability of the 7-10 μ m and 10-15 μ m particle counts should be considered questionable. See instrument QA/QC verification results in Section 4.5.3.

Table 4-7. Permeate Particle Counts

	Size						Cumulative
	2-3 μ m	3-5 μ m	5-7 μ m	7-10 μ m	10-15 μ m	>15 μ m	
Average	3.1	0.10	0.021	0.021	0.016	0	3.3
Minimum	0	0	0	0	0	0	N/A
Maximum	60	44	5.8	4.6	6.6	0	N/A
Std. Dev.	3.2	0.92	0.16	0.13	0.13	0	N/A
Confidence Interval	(0, 7.5)	(0, 1.4)	(0, 0.23)	(0, 0.20)	(0, 0.20)	N/A ¹	N/A

N/A = Not Applicable. Statistical measurements on cumulative data do not generate meaningful data.

N/A¹ = Not Applicable because standard deviation = 0

Note: Due to results obtained during the QA/QC task involving verification of the calibration of the particle counters, the above readings were on average 51% lower than actual. See instrument QA/QC verification results in Section 4.5.3.

Table 4-8. Daily Average Cumulative Particle Counts Feed and Finished Water, Log₁₀ Particle Removal

Date	Feed	Permeate	Log ₁₀ Removal
2/4/99	94	2.9	1.5
2/5/99	94	3.2	1.5
2/6/99	86	1.3	1.8
2/7/99	50	1.8	1.5
2/8/99	63	3.0	1.3
2/9/99	96	5.0	1.3
2/10/99	77	4.0	1.3
2/11/99	70	3.6	1.3
2/12/99	100	3.4	1.5
2/13/99	95	4.3	1.3
2/16/99	87	3.1	1.4
2/17/99	86	2.8	1.5
2/18/99	72	3.0	1.4
2/19/99	58	2.8	1.3
2/20/99	51	4.2	1.1
2/21/99	51	2.8	1.3
2/22/99	49	5.2	1.0
2/23/99	47	4.6	1.0
2/24/99	65	3.6	1.3
2/25/99	53	2.0	1.4
2/26/99	87	3.3	1.4
3/1/99	130	4.3	1.5
3/2/99	120	2.6	1.7
3/3/99	140	2.4	1.8
3/4/99	170	3.5	1.7
3/5/99	170	2.4	1.8
3/6/99	200	2.4	1.9
3/7/99	190	3.6	1.7
3/8/99	170	4.3	1.6
3/9/99	185	2.6	1.9

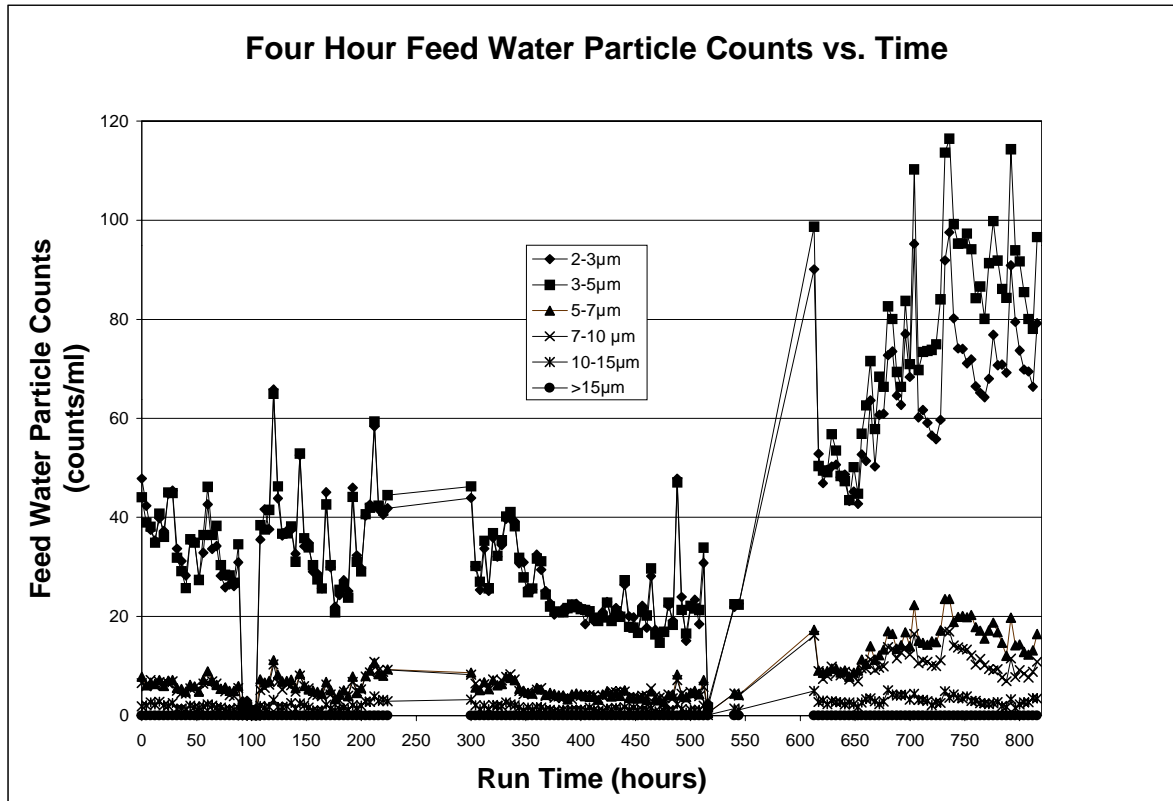

Figure 4-3. Four Hour Feed Water Particle Counts

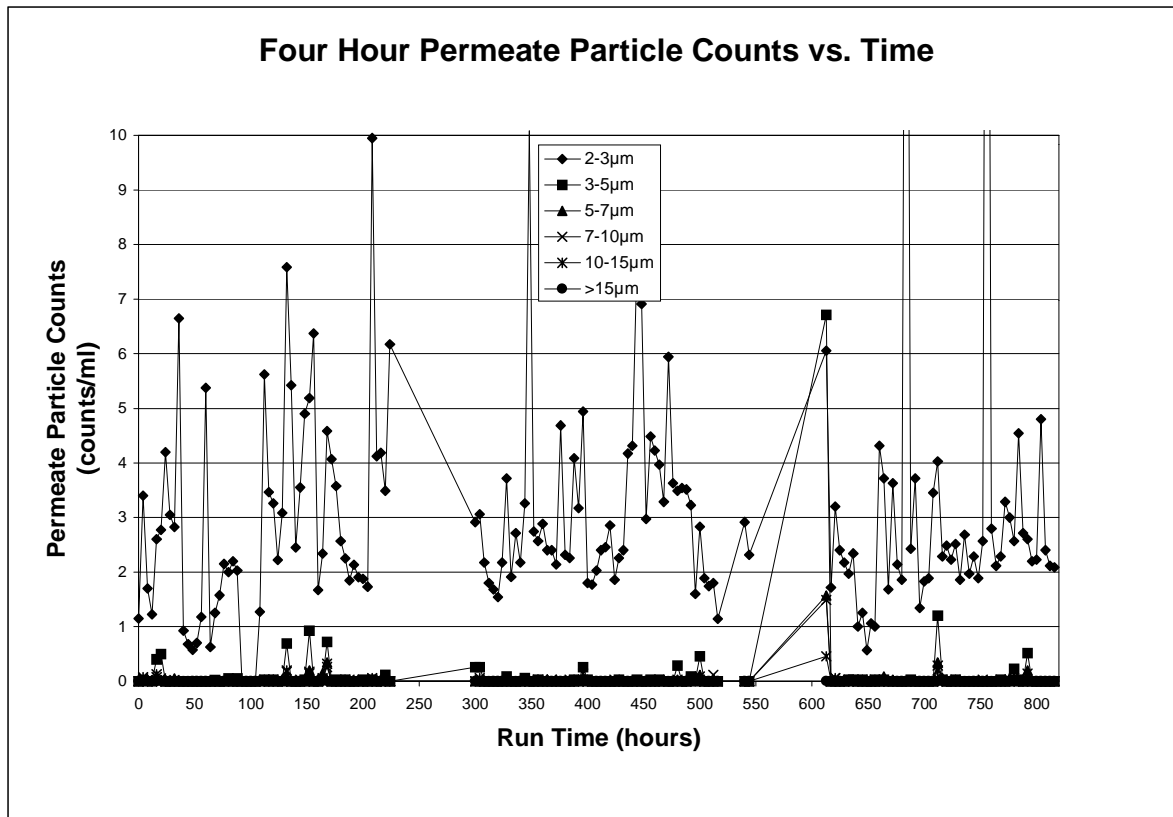

Figure 4-4. Four Hour Permeate Particle Counts

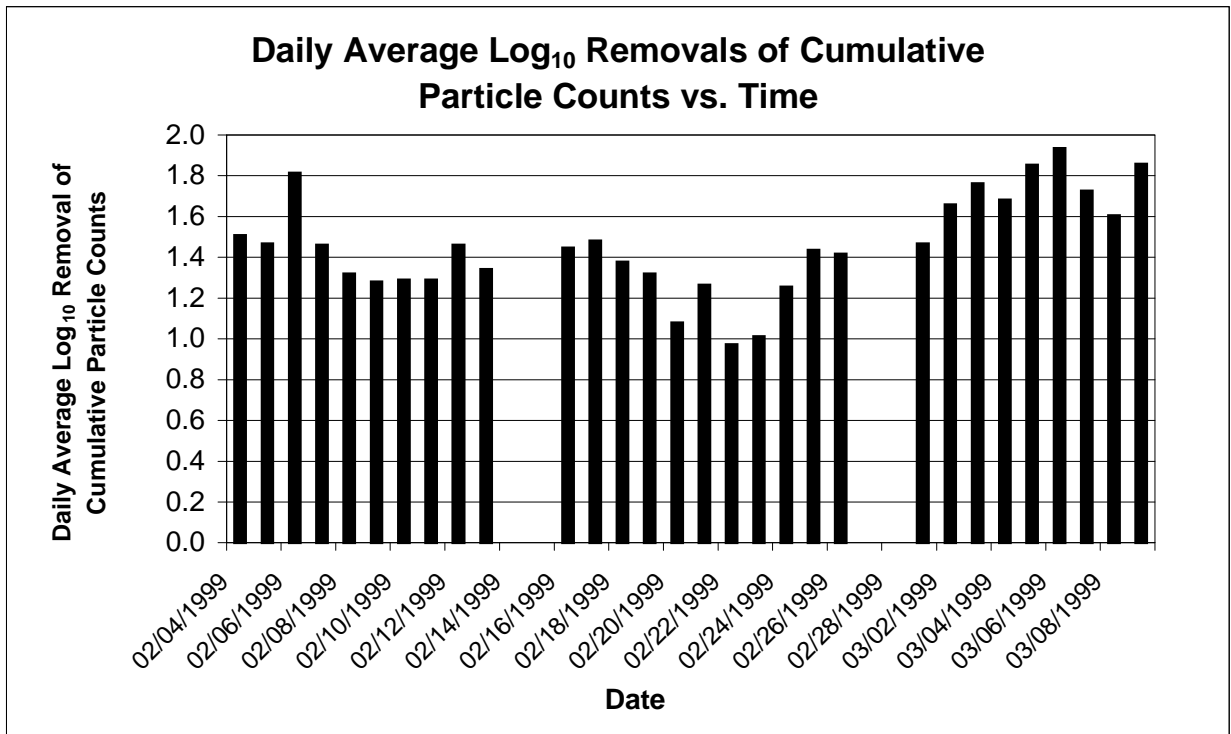

Figure 4-5. Daily Average Log₁₀ Cumulative Particle Removal Graph

4.3.3.3 Feed and Finished Water Testing Results

The results of the testing of the feed water for Total Alkalinity, Total Hardness, TDS, TSS, Total Coliforms, HPC, TOC, UVA₂₅₄, and Algae are presented in Table 4-9. The results of the testing of the finished water for Total Alkalinity, Total Hardness, TDS, TSS, Total Coliforms, HPC, TOC, UVA₂₅₄, and Algae are presented in Table 4-10. A complete data table is presented in Appendix C.

Table 4-9. Feed Water Testing Results

	Parameter									
	Total Alkalinity (mg/l as CaCO ₃)	Total Hardness (mg/l as CaCO ₃)	TDS (mg/l)	TSS (mg/l)	Total Coliforms (cfu/100 ml)	HPC (cfu/100 ml)	TOC (mg/l)	DOC (mg/l)	UVA (cm ⁻¹)	Algae (cells/ml)
Average	40	94	174	0.095	0	111	1.81	1.94	0.018	14
Minimum	35	90	148	<0.05	0	28	1.57	1.61	0.016	<8
Maximum	43	100	214	0.35	0	188	2.20	2.30	0.025	32
Std. Dev.	3.1	4.1	26.5	0.14	0	71	0.242	0.309	0.0025	11
Confidence Interval	(37, 43)	(90, 97)	(150, 197)	(0, 0.22)	N/A	(48, 173)	(1.60, 2.02)	(1.67, 2.21)	(0.015, 0.020)	(4, 23)

N/A = Not Applicable because standard deviation = 0

Note: Calculated averages for less than results (<) utilize half of the Level of Detection (0.05 mg/l) or 0.025 mg/l in these calculations. (Gilbert, 1987).

Table 4-10. Finished Water Testing Results

	Parameter									
	Total Alkalinity (mg/l as CaCO ₃)	Total Hardness (mg/l as CaCO ₃)	TDS (mg/l)	TSS (mg/l)	Total Coliforms (cfu/100 ml)	HPC (cfu/100 ml)	TOC (mg/l)	DOC (mg/l)	UVA (cm ⁻¹)	Algae (cells/ml)
Average	39	97	179	0.065	0	22	4.30	3.90	0.018	<8
Minimum	37	94	138	<0.050	0	8	3.18	3.21	0.016	<8
Maximum	42	102	265	0.15	0	58	5.00	5.07	0.022	<8
Std. Dev.	1.9	3.0	51.3	0.058	0	21	0.707	0.709	0.0025	0
Confidence Interval	(38, 41)	(95, 100)	(134, 224)	(0.015, 0.12)	N/A	(3, 40)	(3.68, 4.92)	(3.28, 4.53)	(0.016, 0.020)	N/A

N/A = Not Applicable because standard deviation = 0

Note: Calculated averages for less than results (<) utilize half of the Level of Detection (0.05 mg/l) or 0.025 mg/l in these calculations. (Gilbert, 1987).

The following observations were made after examination of the results of feed and finished water testing.

Significant reductions were seen in HPC. HPC averaged 111 cfu/100ml in the feed water. Permeate HPC concentrations were 22 cfu/100ml on average. This was likely due to the physical removal of the bacteria on the membrane surface. (The presence of HPC in the permeate may have been due to the inability to completely disinfectant the Tygon sample lines.)

Algae concentrations were reduced. Feed water contained 14 cells/ml on average. No algae was detected in the permeate in the four samples analyzed during the verification testing.

A slight reduction of TSS was observed. The feed water was very low in TSS, 0.095 mg/l on average. The finished water contained 0.050 mg/l on average. Given the results of the statistical analysis on the feed and finished water TSS, this reduction does not appear to be statistically significant.

The membrane system unit had little or no effect on the total alkalinity, total hardness, and TDS. This was not unexpected since these parameters are not present in the water as solid constituents and are not amenable to reduction by physical straining.

TOC and UVA₂₅₄ were not well removed from the feed water. The values of UVA₂₅₄ in both the feed water and permeate were very similar as the respective confidence intervals overlapped and average values were nearly identical. These results suggested that the ultrafiltration membrane did not affect dissolved organic chemicals.

The TOC values were higher in the permeate than in the feed water by approximately 2.5 mg/L. The TOC values were consistently higher in the permeate in each of the four samples analyzed. These same samples were also analyzed for dissolved organic carbon (DOC) and showed that the level of DOC was actually slightly higher on average than the TOC. The reason for this increase is unknown but may be due to analytical error. PWSA's laboratory reports are attached in Appendix H. Considering that the UVA₂₅₄ values were nearly identical between the feed water and permeate and considering the results of the TOC/DOC analyses, the TOC/DOC is most likely from dissolved organic chemicals not absorbing at the 254-nanometer wavelength.

There are very few sources of DOC that could account for the observed increase in TOC. Biological growth in the plumbing systems of the treatment system is the most likely source of DOC in the permeate. The membrane package plant, which included plumbing components and the membrane module, was on line at the test site for four months prior to the ETV testing. The plumbing components of the package plant were made of polyvinylchloride (PVC). Also, the membrane module cleaning cycle was composed of a chlorine solution of approximately 200 mg/l. The solution was allowed to soak in the membrane for an hour and then run to waste. The permeate line from the module was not contacted or soaked in the chlorine solution and therefore would not have experienced any major disinfection. Bacterial growth may have occurred throughout the plumbing system during the time prior to ETV testing and the resulting biofilm may have contributed to the DOC, although no biofilm growth on the plumbing or biofilm sloughing was observed during visual inspections. Without additional research, which is outside the scope of this verification study, the actual source of DOC is not known, but considering the circumstances of testing, unexpected bacterial growth in the permeate sample line prior to this testing could account for the observed increase in the TOC/DOC. Total coliform reduction could not be demonstrated due to the absence of total coliforms in the feed water and permeate throughout the test.

The feed water temperature averaged 3.9°C, ranging from 3.3°C to 4.5°C.

4.3.3.4 Backwash Wastewater Testing Results

Daily and weekly testing was conducted on the backwash wastewater. The results of the testing are listed in Table 4-11 and Table 4-12. A complete data table is presented in Appendix C.

Table 4-11. Daily Backwash Wastewater Testing Results – Summary

	Parameter			
	Turbidity (NTU)	Turbidity (dup) (NTU)	Chlorine Residual (mg/l)	Chlorine Residual (dup) (mg/l)
Average	1.57	1.67	0.74	0.74
Minimum	0.16	0.26	0.50	0.50
Maximum	6.62	6.50	0.99	1.03
Standard Deviation	1.60	1.77	0.13	0.14
Confidence Interval	(1.17, 1.98)	(1.04, 2.30)	(0.69, 0.78)	(0.69, 0.79)

Table 4-12. Weekly Backwash Wastewater Testing Results

	Parameter		
	TSS (mg/l)	Total Coliforms (cfu/100 ml)	HPC (cfu/100 ml)
Average	1.25	0	135
Minimum	0.25	0	92
Maximum	3.20	0	170
Standard Deviation	1.17	0	33
95% Confidence Interval	(0.227, 2.27)	N/A	(98, 172)

N/A = Not Applicable because standard deviation = 0

The turbidity of the backwash waste was somewhat variable but averaged 1.57 NTU. The chlorine residual was relatively consistent averaging 0.74 mg/l. TSS content in the backwash waste was relatively consistent averaging 1.25 mg/l; indicating that the backwash procedure was removing some particulate material. Total coliforms were absent in the backwash waste but HPC was observed.

4.3.3.5 Total Suspended Solids Mass Balance

The mass balance of TSS was calculated from the amount of suspended solids entering the treatment system, the amount in the finished water, and the amount in the backwash waste. There is a portion of the TSS which will not be removed by backwashing and accumulates on the membrane; the majority of this accumulated material is presumably dissolved and removed by chemical cleaning.

To calculate the amount of TSS in the treatment stream the following equation was used:

$$\text{lbs/day} = \text{Amount of TSS in mg/l} * [(8.34\text{lb}) / (\text{mg/l} * \text{MG})] * \text{Flow MGD}$$

Pounds of TSS in feed water:

$$\text{Average feed water TSS (from Table 4-10)} = 0.095 \text{ mg/l}$$

Calculate the feed water flow in MG: $(41.22 \text{ gpm}) * (1440 \text{ min/day}) = 59356.8 \text{ gal/day} / (1,000,000 \text{ gal/MG}) = 0.0592 \text{ MGD}$.

$$\text{lbs/day} = 0.095 \text{ mg/l} * [(8.34\text{lb}) / (\text{mg/l} * \text{MG})] * 0.0592 \text{ MGD} = 0.0469 \text{ lbs/day}$$

Pounds of TSS in finished water:

$$\text{Average finished water TSS (from Table 4-11)} = 0.05 \text{ mg/l}$$

Calculate the finished water flow in MG: $(41.12 \text{ gpm}) * (1440 \text{ min/day}) = 59212.80 \text{ gal/day} / 1,000,000 \text{ gal/MG} = 0.0592 \text{ MGD}$.

$$\text{lbs/day} = 0.050 \text{ mg/l} * [(8.34\text{lb}) / (\text{mg/l} * \text{MG})] * 0.0592 \text{ MGD} = 0.0247 \text{ lbs/day}$$

Pounds of TSS in backwash wastewater:

$$\text{Average wastewater TSS (from Table 4-13)} = 1.25 \text{ mg/l}$$

Calculate the amount of wastewater produced daily in MG: $(50 \text{ gallons per backwash}) * (24 \text{ backwashes per day}) = 1200 \text{ gallon per day} / 1,000,000 \text{ gal/MG} = 0.0012 \text{ MGD}$

$$\text{lbs/day} = 1.25 \text{ mg/l} * [(8.34\text{lb}) / (\text{mg/l} * \text{MG})] * 0.0012 \text{ MGD} = 0.0125 \text{ lbs/day}$$

Pounds of TSS accumulating on membrane:

This figure is the difference between the amount of TSS added to the membrane and the amount of TSS removed during backwash. The majority of this portion of the TSS is removed during the chemical cleaning process. The amount of TSS in the cleaning waste is not quantifiable due to the nature of the solids in the waste (i.e. TDS).

The TSS mass balance equals:

Pounds of TSS in influent = pounds of TSS in effluent + pounds of TSS in backwash waste + pounds of TSS accumulating on the membrane.

$0.0469 \text{ lbs/day TSS in influent} = 0.0247 \text{ lbs/day TSS in effluent} + 0.0125 \text{ lbs/day TSS in backwash waste} + 0.0097 \text{ lbs/day accumulating on the membrane}$.

The TSS mass balance calculation would seem to indicate that the backwashing procedure was not completely effective at removing the particulate material deposited on the membrane. The majority of the TSS remaining on the membrane was presumably removed during the chemical cleaning process. Due to the nature of the chemical cleaning wastes (i.e. TDS rather than TSS), this presumption can not be verified.

4.3.4 Task 4: Reporting of Maximum Membrane Pore Size

The manufacturer reports that the membrane used during the verification testing has a maximum pore size of 0.05 μm and that 90% of the pores in their membrane are equal to or less than 0.036 μm . These results were generated through the use of Scanning Electron Microscopy and Coulter Porometry. These results were provided by the manufacturer and were not verified during the ETV testing. Appendix G contains a report from Leopold and X-Flow in which the results of a number of different analytical methods are discussed.

4.3.5 Task 5: Membrane Integrity Testing

The methods employed for detecting a compromised membrane during the ETV test were air pressure hold test, turbidity reduction monitoring, and particle count reduction monitoring. These tests were run on an intact membrane and one that had been intentionally compromised. Testing was conducted April 1, 1999. A complete data table is presented in Appendix C. The following is a discussion of the membrane integrity testing results.

4.3.5.1 Air Pressure Hold Test Results

The membrane vessel with the intact membrane remained in the treatment unit and the permeate side was drained. The membrane itself was fully wetted (i.e. membrane pores were filled with water). The membrane was air pressurized up to 8.0 psi (0.55 b). The permeate side was sealed and the pressure decline rate was monitored using an air pressure gauge.

At time zero the air pressure was 8.1 psi (0.56 b) and after five minutes the air pressure was 8.0 psi (0.55 b). This demonstrated that the membrane was intact. (An intact membrane would be expected to lose no more than 1.0 psi [0.069 b] every 5 minutes.)

Air pressure loss was also compared to the loss that was obtained when testing a compromised membrane. The membrane was intentionally compromised by removing the membrane vessel, exposing the fibers themselves and severing a fiber.

The membrane vessel was then replaced and fully wetted and the membrane was air pressurized to 8.2 psi (0.57 b). After five minutes the air pressure was 6.9 psi (0.48 b). The membrane lost 1.3 psi (0.090 b) in five minutes and this demonstrated that the membrane was compromised.

4.3.5.2 Turbidity Reduction Monitoring

Turbidity of feed and permeate water was monitored. An intact membrane would be expected to show a 90% reduction in turbidity from feed to permeate. Due to the high quality of the feed

water (the average feed turbidity was 0.09 NTU) showing a 90% reduction, 0.009 NTU, was beyond the capability of the turbidimeters.

Permeate turbidity between an intact and a compromised membrane was compared. An increase of 100% was used as an indication of a compromised membrane. The turbidity in the permeate, as measured by the inline turbidimeter, in the ten hours before the membrane was compromised averaged 0.024 NTU. The turbidity of the permeate in the hour after the membrane was compromised was 0.024 NTU.

Turbidity reduction monitoring between feed and finished water was not possible due to the low feed water turbidity level. The permeate turbidity produced by an intact membrane was not significantly different than the permeate turbidity produced by a compromised membrane. Comparison of the permeate turbidity between intact and compromised membranes was not a reliable way to detect a compromised membrane for the low turbidity feed water at the test site.

4.3.5.3 Particle Count Reduction Monitoring

Particle count reductions from source to finished water of 99.9% would demonstrate an intact membrane. Due to the high quality of the feed water (the average cumulative feed water particle counts were 100 total counts per ml) showing a 99.9% reduction was pushing the limits of the instrumentation.

Differences between permeate particle counts from an intact and a compromised membrane were compared. An increase of 100% was used as an indication of a compromised membrane. The average cumulative particle count of the permeate in the 10 hours before the membrane was compromised was 1.9 counts/ml. The average cumulative particle count of the permeate in the hour after the membrane was compromised was 2.7 counts/ml.

Particle count reduction monitoring between feed and finished water was difficult due to high quality of the feed water. The specified reduction from feed to finished to demonstrate an intact membrane was 99.9%. The average particle count percent removal during the verification (with the intact membrane) was 97%. Particle counts of the compromised membrane were 42% higher than those produced by the intact membrane. Comparison of particle counts between intact and compromised membranes was not a reliable way to detect a compromised membrane for the feed water at the test site.

4.3.6 Task 6: Microbial Removal

The purpose of this task was to demonstrate the treatment unit's ability to provide a minimum 3 \log_{10} removal from feed water to plant effluent of *Giardia* cysts and a 2 \log_{10} removal of *Cryptosporidium* oocysts. The system operated at an average flux of 190 l/m²/h at 20°C (110 gfd at 68°F) and a specific flux of 310 l/m²/h/b at 20°C (12 gfd/psi 68°F) during the microbial removal challenge testing. The lab report submitted by PWSA is attached in Appendix H.

4.3.6.1 Feed Water Concentrations

During the *Giardia* and *Cryptosporidium* removal challenge testing, the feed water had a pH of 7.7, a turbidity of 0.08 NTU, and a temperature of 4.7°C. Based on the results of replicate counts from loading multiple hemocytometers, a total of 13,800,000 *Giardia* cysts and 98,947,000 *Cryptosporidium* oocysts were added to 50 gallons of feed water in the feed water reservoir. This resulted in a concentration of 276,000 *Giardia* cysts per gallon and 1,978,940 *Cryptosporidium* oocysts per gallon in the feed water. The stock suspension of feed water and the cysts and oocysts was constantly mixed using a drum mixer. A diaphragm pump was used to add the stock suspension to the Leopold Ultrabar Mark III Ultrafiltration System. The pump was operated at about 3.2 lpm (0.85 gpm) and was capable of overcoming the pressure in the feed water line of the treatment unit. The feed water from the feed water reservoir was fed to the system for approximately 60 minutes.

As a QC check of the hemocytometer counts, a composite of the feed water was created from five two-ml aliquots taken at five to ten minute intervals. Microscopic examination of the results of this composite indicated 12,920,000 *Giardia* cysts and 103,740,000 *Cryptosporidium* oocysts. These results were 6.4% less and 4.6% greater, respectively, than the results obtained from the hemocytometer counts. The hemocytometer counts were used to calculate the initial concentration of the feed water per EPA protocols and due to the uncertain nature of sampling and mixing of the suspension, which could render the composite sample results questionable. The feed water results of the replicate hemocytometer counts are presented in Table 4-13. The microscopic examination results of the composite sample are presented in Table 4-14. Bench data sheets and report from the laboratory are enclosed in Appendix H.

Table 4-13. *Giardia* and *Cryptosporidium* Stock Suspension Results by Hemocytometer Counts

	<i>Giardia</i> Cysts	<i>Cryptosporidium</i> Oocysts
Average count (oocysts or cysts/0.0001ml)	172	1,319
Standard Deviation	25	121
Confidence Interval	(148, 197)	(1,201, 1,438)
Total cysts and oocysts added to feed water reservoir (8 mls of stock suspension <i>Giardia</i> , 7.5 mls <i>Cryptosporidium</i>)	13,800,000	98,947,500
Feed Water Amount Confidence Interval	(11,0082,772, 14,792,228)	(90,058,843, 107,841,157)

Table 4-14. Feed Water Reservoir Concentrations of *Giardia* and *Cryptosporidium* by Microscopic Examination

	<i>Giardia</i> Cysts	<i>Cryptosporidium</i> Oocysts
Presumptive count (oocysts or cysts/ml)	68	546
Total cysts and oocysts added to feed water reservoir	12,920,000	103,740,000

4.3.6.2 Permeate Concentrations

No *Giardia* cysts or *Cryptosporidium* oocysts were identified in the permeate as shown by the absence of cysts and oocysts on the 1 µm yarn-wound capture filter. These results demonstrated a 4.9 log₁₀ removal of *Giardia* cysts and a 5.8 log₁₀ removal of *Cryptosporidium* oocysts. During the *Giardia* and *Cryptosporidium* removal challenge testing, the permeate, as measured by the

inline turbidimeter, had a turbidity of 0.024 NTU and an average cumulative particle counts of 5.0 counts/ml.

The log₁₀ removal of *Giardia* cysts or *Cryptosporidium* oocysts was calculated by first dividing the amount of permeate sampled by the total amount of permeate filtered by the system. In this case, one gpm was filtered through the sampling filter compared to 40 gpm of permeate produced by the treatment system. This result was applied to the total amount of cysts added to the treatment system and used to calculate the total amount of cysts which could have been trapped on the sampling filter. This number was converted to its log₁₀ equivalent. The percent recovery of the test method at the PWSA laboratory is 25%, this means that the lowest number of cyst or oocysts that could be detected is four. That is, if four cysts or oocysts were in the permeate one of them would be detected. This number, four, was also converted to its log₁₀ equivalent. The final log removal calculation was made by subtracting the log₁₀ of the number of cysts added to the sampling filter less the log₁₀ of the number of cysts trapped on the sampling filter, in this case zero, and then subtracting the log₁₀ of the number four. Table 4-16 presents the concentrations and the log₁₀ removal calculations of the *Giardia* cysts and *Cryptosporidium* oocysts.

Table 4-15. *Giardia* and *Cryptosporidium* Challenge Log₁₀ Removal Calculation

	<i>Giardia</i> Cyst Removal	<i>Cryptosporidium</i> Oocyst Removal
Cysts/oocysts in Feed Reservoir (from Table 4-13)	13,800,000	98,947,500
Cysts/oocysts Added to Capture Filter (The total number of cysts/oocysts in Feed Reservoir multiplied by 2.5% because the system was pumping at 40 gpm and sampled at 1 gpm. Effectively, only 2.5% of the total cysts/oocysts added could have been detected on the capture filter.)	345,000	2,473,688
Log ₁₀ of cysts/oocysts Added to Capture Filter	5.5	6.4
Log ₁₀ of Method Recovery (PWSA laboratory method recovery is 25%, i.e. 1 in 4.)	0.60	0.60
Log ₁₀ Removal (Difference of Log ₁₀ of cysts/oocysts Added to Capture Filter and Log ₁₀ of Method Recovery)	4.9	5.8

4.3.6.3 Backwash Examination

Examination of the wastewater was conducted to assure that the protozoans were added to the membrane system, the organisms were removed by the membrane and that the backwashing procedure was capable of removing the protozoans from the membrane system. Five hundred ml of the backwash waste was collected and examined. Both *Giardia* cysts and *Cryptosporidium* oocysts were observed in the sample. Quantification of the numbers of each organism in the sample was not done.

4.3.6.4 Operational and Analytical Data Tables

The operation of the treatment system was monitored during the challenge testing. Pressure readings and flow rates were recorded. Results of these readings are presented in Tables 4-16 and 4-17. Turbidity and particle count readings were taken during the challenge testing.

Samples for feed water turbidity and particle counts were collected upstream of the point where the *Giardia* cysts and *Cryptosporidium* oocysts were added to the feed water stream. Results of the turbidity and particle count readings are presented in Tables 4-18, 4-19, and 4-20. Backwash of the system was delayed, as per protocol requirements, until after the challenge testing was completed. Samples of backwash water before and after the challenge were collected and analyzed. Results of these analyses are presented in Table 4-21.

Table 4-16. Pressure Readings and Calculations During Microbial Removal Testing

Date	Time	Feed Pressure (b)	Permeate Pressure (b)	Transmembrane Pressure (b)
3/19/99	10:25	1.2	0.56	0.63
3/19/99	13:20	1.2	0.55	0.61

Table 4-17. Specific Flux During Microbial Removal Testing

Date	Time	Specific Flux (l/h/m ² /b @20°C)
3/19/99	10:25	310
3/19/99	13:20	310

Table 4-18. Turbidity Analyses Results and Removal During Microbial Removal Testing

Date	Time	Feed Turbidity (NTU)	Turbidity (duplicate) (NTU)	Permeate Turbidity (NTU)	Amount Removed (NTU)
3/19/99	9:30	0.09	0.09	0.024	0.066
3/19/99	10:35	0.06			

Table 4-19. Feed Water Particle Counts 3/19/1999

	Size						Cumulative
	2-3µm	3-5µm	5-7µm	7-10µm	10-15µm	>15µm	
Average	78	130	29	12	3.0	0	250
Minimum	50	78	18	6.5	1.6	0	N/A
Maximum	210	280	55	38	14	0	N/A
Std Dev	14	16	3.8	3.2	1.3	0	N/A
95% Confid Int	(59, 97)	(100, 150)	(24, 34)	(7.8, 17)	(1.2, 4.9)	N/A ¹	N/A

N/A = Not Applicable. Statistical measurements on cumulative data do not generate meaningful data.

N/A¹ = Not Applicable because standard deviation = 0

Note: Due to results obtained during the QA/QC task involving verification of the calibration of the particle counters, the above readings the readings for the feed water particle counts from 2-7 µm should be increased by 26% to account for the low response of the feed water particle counts. Due to extremely low results in the 10 µm size range, the reliability of the 7-10 µm and 10-15 µm particle counts should be considered questionable. See instrument QA/QC verification results in Section 4.5.3.

Table 4-20. Finished Water Particle Counts 3/19/1999

	Size						Cumulative
	2-3µm	3-5µm	5-7µm	7-10µm	10-15µm	>15µm	
Average	4.9	0.086	0.019	0.016	0.0081	0	5.0
Minimum	0.77	0	0	0	0	0	N/A
Maximum	41	3.1	0.54	0.34	0.17	0	N/A
Std Dev	6.0	0.32	0.067	0.051	0.024	0	N/A
95% Confid Int	(0, 13)	(0, 0.53)	(0, 0.11)	(0, 0.087)	(0, 0.041)	N/A ¹	N/A

N/A = Not Applicable. Statistical measurements on cumulative data do not generate meaningful data.

N/A¹ = Not Applicable because standard deviation = 0

Note: Due to results obtained during the QA/QC task involving verification of the calibration of the particle counters, the above readings were on average 51% lower than actual. See instrument QA/QC verification results in Section 4.5.3.

Table 4-21. Daily Backwash Wastewater Testing Results During Microbial Removal Testing

Date	Time	Turbidity (NTU)	Turbidity (dup) (NTU)	Chlorine Residual (mg/l)	Chlorine Residual (dup) (mg/l)
3/19/99	9:15	0.28	0.28	0.53	0.50
3/19/99	14:25	0.41			

Testing of the feed, finished and backwash water for Total Alkalinity, Total Hardness, TDS, TSS, Total Coliforms, HPC, TOC, UVA was not conducted during the challenge testing procedure.

4.3.6.5 Discussion of Results

No *Giardia* cysts or *Cryptosporidium* oocysts were observed in the permeate. The membranes appeared to successfully remove all of the *Giardia* cysts and *Cryptosporidium* oocysts introduced into the treatment system. Since the percent recovery of the analytical method is 25%, there is a slight possibility that some cysts or oocysts passed through the membrane and were not identified during analysis. Nevertheless, the treatment system provided 4.9 log₁₀ removal of *Giardia* cysts and a 5.8 log₁₀ removal of *Cryptosporidium* oocysts. These results indicate that the treatment system would be capable of successfully complying with the current protozoan removal requirements of the SWTR and ESWTR, if used on this source water. The current provisions are 3 log₁₀ removal of *Giardia* cysts and 2 log₁₀ removal of *Cryptosporidium* oocysts as stated in Section 3.1.1.2.

The log₁₀ removals of the *Giardia* cysts and *Cryptosporidium* oocysts were limited by the amount of the parasites which were present in the stock feed solution, the percentage of the permeate that could be sampled, and the percent recovery of the analytical methodology. Higher feed concentrations, percentage of permeate examined and percent recovery of the analytical methods may yield higher log₁₀ removals.

4.4 Equipment Characteristics Results

The qualitative, quantitative and cost factors of the tested equipment were identified during verification testing, in so far as possible. The results of these three factors are limited due to the relatively short duration of the testing cycle.

4.4.1 Qualitative Factors

Qualitative factors that were examined during the verification testing were the susceptibility of the equipment to changes in environmental conditions, operational reliability, and equipment safety.

4.4.1.1 Susceptibility to Changes in Environmental Conditions

Changes in environmental conditions that cause degradation in feed water quality can have an impact on the treatment system. The short duration of the testing cycle and the stable nature of the feed water minimized the opportunity for significant changes in environmental conditions. As previously stated, the reservoir water was treated (coagulated, flocculated, settled, filtered, and disinfected) surface water that had been pumped from PWSA's Aspinwall treatment plant.

The fact that the feed water was finished drinking water stored in an open reservoir limited the opportunity for significant changes in feed water quality. No environmental upsets significant enough to affect feed water quality occurred during testing. Since the treatment unit is housed in a 20-foot long sea-going (watertight) container and is not exposed to the elements, opportunities for environmental upsets were limited.

4.4.1.2 Operational Reliability

During the verification test, the unit operated in the automatic mode. There were three interruptions of the process during the testing period. The first interruption occurred February 13 when the FTO's field representative broke the permeate sample line during sample collection. The sample line was broken before the shut off valve and the unit had to be shut down. Repairs were made and the system was restarted on February 16. The second interruption occurred on February 25. The treatment unit's display screen indicated that a low air pressure alarm was the cause of the shutdown. No malfunction of the unit's air system was found. The unit was restarted and back in service February 26. The third failure occurred on February 27. The treatment unit's display screen indicated that a low level in the feed water reservoir had caused the shut down. Due to the lack of available feed flow, it was necessary to slightly decrease the flow rate through the unit to maintain operation of the system.

Manual operation was required for chemical cleaning of the system and to conduct the air pressure hold test. A representative of the owner visited the site two to three times per week primarily to download and transmit data from the personal computers (PCs). While on-site, the representative also visually checked the system.

4.4.1.3 Equipment Safety

Evaluation of equipment safety was conducted as part of the verification testing. Evaluation of the safety of the treatment system was done by examination of the components of the system and identification of hazards associated with these components. A judgement as to the safety of the treatment system was made from these evaluations.

There are safety hazards associated with high voltage electrical service and pressurized water. The electrical service was connected according to local code requirements and did not represent an unusual safety risk. The water pressure inside the treatment system was relatively low and did not represent an unusual safety risk.

The sodium hypochlorite used for membrane cleaning created a safety concern. The use of appropriate personal protective equipment (PPE) minimizes the risk of exposure when handling the chemical. The prompt and proper clean up of spills also minimizes the hazards associated with this chemical.

No injuries or accidents occurred during the testing.

4.4.2 Quantitative Factors

Quantitative factors that were examined during verification testing were power supply requirements, consumable requirements, waste disposal technique, and length of operating cycle.

Cost factors for the above items are discussed where applicable. It is important to note that the figures discussed here are for the Leopold Ultrabar Mark III Ultrafiltration System operating at 216 l/m²/h at 20°C (128 gfd at 68°F). Costs will vary if the system is operated at different flux rates.

4.4.2.1 Power Supply Requirements

The unit was operated with 460V 3 phase 60Hz service with 30 Amp current as required by the O&M manual. Daily power consumption of the treatment unit was determined by reading a dedicated electric meter. The electric meter was installed by a certified electrician according to the local electric code.

The unit used an average of 25 kilowatt hours (kwh) per day. The highest recorded daily usage was 73 kwh; the minimum daily usage was four kwh. The high use reading was obtained on February 16, the day the unit was restarted after a four day shut down. The high usage may have been due to some power consumption after the last meter reading was taken prior to the shut down and some consumption after the restart before the next meter reading. The low usage (4 kwh) was followed by a day of relatively high usage (32 kwh). The readings of four kwh was taken 18 hours after the previous reading and the 32 kwh was taken 30 hours after the four kwh. This may account for some of the differences in the daily readings.

The average production of the unit was 5.12 gfd at 68°F per kwh.

4.4.2.2 Consumable Requirements

The only consumable commodity was sodium hypochlorite the cleaning chemical used during the verification testing. This required approximately 1000 mls of 5.25% sodium hypochlorite per cleaning.

4.4.2.3 Waste Disposal

The wastes generated by the treatment system were backwash water and the chemical cleaning wastes. The microbial challenge testing also generated wastes during the verification testing. All of these wastes were disposed of to an existing catch basin that was connected to PWSA's sewerage system. The unit produces approximately 1200 gpd of backwash water during verification testing.

The characterization of the cleaning wastewater indicated that the solution was alkaline, with a pH of 9.1. The cleaning waste had a turbidity of 23 NTU and a TDS of 512 mg/l. The total chlorine residual of the caustic/chlorine cleaning waste was 114 mg/l. The cleaning waste had a dark brown color.

The backwash waste was finished water, residual chlorine and solids removed from the membrane; it required no treatment prior to discharge to the sewers. The average concentration of TSS in the backwash waste was 1.25 mg/l. The range of TSS concentration was from 0.25 mg/l to 3.20 mg/l. The chlorine concentration in the backwash wastewater averaged 0.74 mg/l and ranged from 0.50 mg/l to 0.99 mg/l.

A complete presentation of the backwash wastewater and chemical cleaning waste data is included in Appendix C.

The microbial challenge utilized formalin-fixed *Giardia* cysts and *Cryptosporidium* oocysts. The backwash waste from the challenge test was collected, chlorinated, and stored for 3 days prior to discharge.

4.4.2.4 Length of Operating Cycle

There were two "operating cycles" to be considered; the filtration cycle and the interval between chemical cleaning. The lengths of these operating cycles are site-specific and determined by the manufacturer after evaluation of the feed water quality. These cycle lengths are easily field adjustable if necessary; no adjustments were required for this verification.

The filtration cycle is the length of time between system backwashes. The interval between backwashes is made based on the maintenance of flux. That is, if the backwash is not able to maintain flux at a particular level, the frequency of backwashing is increased. The filtration cycle was 60 minutes for the verification study. The backwash required 50 seconds to complete, which included 15 seconds for system shutdown and various valve operations and 35 seconds for the backwash itself.

The interval between chemical cleaning was not readily apparent due to the short duration of the study and the high quality of the feed water. The treatment system did not reach the termination criteria for initiation of chemical cleaning. Leopold recommends that cleaning be done when the TMP rises more than 10% from starting point. (i.e. If starting at 20 psi [1.4 b] feed, cleaning should be initiated when feed pressure is at 22 psi [1.5 b] at the start of the service cycle after regular backwashing). Based on feed water quality at the test site, the initial operations experience, and verification testing results, the manufacturer estimated that the cleaning interval would be slightly in excess of one month at this site.

4.5 QA/QC Results

The daily, bi-weekly, initial and the analytical laboratory QA/QC verification results are presented below.

4.5.1 Daily QA/QC Results

Daily readings for the inline turbidimeter flow rate and readout and inline particle counter flow rate QA/QC results were taken and recorded.

The inline permeate turbidimeter flow rate averaged 346 ml/minute. The flow rate was measured using a graduated cylinder and stop watch. The maximum rate measured during the testing was 2000 ml/minute; the minimum was 100 ml/minute. The acceptable range of flows as specified by the manufacturer is 250 ml/minute to 750 ml/minute. Six adjustments of the flow rate were required during the verification testing. As previously mentioned, the turbidimeter seemed to be giving erroneously high readings due to an accumulation of air in the turbidimeter body. For this reason, the turbidimeter was drained and the flow rate reset every day during the last ten days of testing.

The daily readings from the inline turbidimeter averaged 0.082 NTU; the average from the benchtop turbidimeter was 0.05 NTU. The inline permeate turbidimeter did not appear to be operating reliably throughout the verification testing frequently displaying readings which appeared to be erroneously high. Some results were four to five times greater than the feed water turbidity. The daily readings from the inline permeate turbidimeter averaged 0.082 NTU. This seemed to be due to an accumulation of air bubbles inside the turbidimeter body. After draining the turbidimeter body the readings would return for a short period of time to within the range of 0.020 to 0.030 NTU. The benchtop turbidimeter tends to give higher results than a properly functioning inline turbidimeter. The benchtop turbidimeter uses a glass cuvette to hold the sample; this cuvette can present some optical difficulties. The inline turbidimeter has no cuvette to present a possible interference with the optics of the instrument. The low level of turbidity in the permeate also can create analytical difficulties, particularly for the benchtop turbidimeter. Manufacturer's specifications state that stray light interference is less than 0.02 NTU for the bench top turbidimeter.

The feed water particle counter flow rate averaged 82 ml/minute. The flow rate was measured using a graduated cylinder and stop watch. The maximum flow rate measured was 85 ml/minute; the minimum was 64 ml/minute. The target flow rate set on site is 80 ml/minute. Efforts were made to keep the flow rate between 76 ml/minute to 84 ml/minute. Adjustments to the flow rate were required 3 times during the verification study.

The finished water particle counter flow rate averaged 67 ml/minute. The flow rate was measured using a graduated cylinder and stop watch. The maximum flow rate measured was 69 ml/minute; the minimum was 61 ml/minute. The target flow rate for the first three days of the verification testing was 75 ml/minute. Adjustments to the instrument were unable to achieve this flow. The target flow rate was adjusted to 65 ml/minute. Efforts were made to keep the flow rate between 62 ml/minute to 68 ml/minute. Adjustment to the flow rate was required once during the verification study.

4.5.2 Bi-weekly QA/QC Verification Results

Every two weeks, checks were made on the inline flow meters; the meters were cleaned out if necessary and the flow readouts were verified.

The flow meters were inspected. Clean-out of the meters was not necessary due to the high quality of the feed and finished water.

The flow meter readout was verified during the testing. The acceptable range of accuracy for the feed, finished and backwash meters was +/- 10%. The feed water meter readout averaged 4.1% lower than actual according to the results obtained during the flow verification. The finished water meter readout averaged 3.1% lower than actual according to the results obtained during the flow verification.

4.5.3 Results of QA/QC Verifications at the Start of Each Testing Period

At the start of the testing period, the inline turbidimeter was cleaned out and recalibrated, the pressure gauges/transmitters readouts were verified, the tubing was inspected, and the inline particle counter calibration was checked.

The inline turbidimeter reservoir was drained and cleaned and the unit was recalibrated according to manufacturer's recommendations. No corrective action was required as a result of these activities.

Verification of the pressure gauge readings could not be accomplished. The treatment system was manufactured in Europe and the pressure gauge inlets were metric in size. The dead test meter's inlet was English in size. The FTO was unable to locate an adapter to allow the gauges to be tested on the dead test meter. NSF was contacted and approved the use of calibrations that had been recently conducted on the pressure gauges by an independent laboratory. These calibration reports are included in Appendix I.

The tubing used on the treatment system was inspected prior to the initiation of testing. The tubing was in good condition and replacement was not necessary.

The calibration of the inline particle counters was checked. The cocktail of microspheres was prepared to give an initial concentration of 2,000 particles/ml for each of the 5 μm , 10 μm , and 15 μm sized particles.

The feed water particle counter showed an average response for the 5 μm size of 1500 counts/ml; the 10 μm size showed an average response of 1000 counts/ml; the 15 μm size showed an average response of 1700 counts/ml. This corresponds to a difference of 26%, 50%, and 15% respectively in particle counts. These results were outside of the generally recognized range of +/- 10%. The manufacturer of the particle counters was contacted to determine what corrective action could be utilized to rectify this low response. The technical representative indicated that unit would have to have been returned to the factory for recalibration. The representative indicated that the lead time for this service was in excess of one month. Due to the short duration of the testing schedule and the treatment system manufacturer's time constraints, this was not a feasible option. The technical representative indicated that the calibration procedure consisted of adjusting the "threshold" of the unit. This consists of adjusting the output of the unit to match the concentration of the standard being analyzed. The representative indicated that this "threshold" adjustment is analogous to increasing the readout of the unit by the percent differences obtained during the calibration check procedure. The average percent difference for the 5 μm standard was 26%. The readings for the finished water particle counts from 2-7 μm should be increased by 26% to account for the low response of the finished water particle counts.

Due to extremely low results in the 10 μm size range, the reliability of the 7-10 μm and 10-15 μm particle counts should be considered questionable. The average percent difference for the 15 μm standard was 15%. The readings for finished water particle counts in the >15 μm obtained during the verification testing should be increased by 15% to account for the low response of the finished water particle counts.

The finished water particle counter showed an average response for the 5 μm size of 790 counts/ml; the 10 μm size showed an average response of 850 counts/ml; the 15 μm size showed an average response of 1300 counts/ml. This corresponds to a difference of 60%, 58%, and 36% respectively in particle counts. As was the case with the feed water particle counter, the long lead time for recalibration by the manufacturer precluded recalibration of the instrument. Due to extremely low results obtained during calibration, the permeate particle count results should be considered questionable.

The particle counters used during the testing were Met-One PCX models. The units had capabilities of measuring particles as small as 2 μm and a coincidence error of less than 10%. Particle counter model, serial number, calibration certificate, and calculation of coincidence error are included in Appendix I.

4.5.4 Analytical Laboratory QA/QC

Samples for analyses conducted on feed and finished water are listed in Table 3-1. QA/QC procedures are based on Standard Methods, 18th Ed., (APHA, 1992) and Methods for Chemical Analysis of Water and Wastes, (EPA 1979).

The laboratory participated in the ICR laboratory approval program sponsored by the EPA. QA/QC results from this program as they relate to microbial testing are attached in Appendix H. The analyses conducted as part of this program include samples with unknown amounts *Giardia* cysts and *Cryptosporidium* oocysts. These samples were analyzed and the results submitted to EPA for evaluation. These blind QA/QC samples were analyzed for 18 months as part of the ICR lab program and served as the QA/QC component of the microbial testing for the verification testing. Results of these QA/QC samples indicate that the controls in place were adequate to render the data obtained from the challenge testing acceptable.

Calibration and QA/QC results of the analytical instrumentation used to conduct the analyses listed in Table 3-1 on finished water is recorded and kept on file at the PWSA laboratory. All QA/QC results for the analytical instrumentation indicate that adequate controls were in place to render the data obtained acceptable.

Chapter 5 References

The following references were used in the preparation of this report:

- American Public Health Association, American Water Works Association, Water Environment Federation. Standard Methods for the Examination of Water and Wastewater, APHA. AWWA, WEF, 18th Ed., 1992.
- American Water Works Association. Partnership for Safe Drinking Water Web Page, AWWA, July, 1999.
- Gilbert, Richard O., Statistical Methods for Environmental Pollution Monitoring, Van Nostrand Rheinhold, 1987.
- PCI/Leopold Membrane Systems - Operations & Maintenance Manual – Ultrabar Pilot #1. PCI/Leopold Membrane Systems, July, 1997.
- Pittsburgh Water and Sewer Authority. Laboratory Quality Assurance Plan, Non Published, January, 1997.
- U.S. Environmental Protection Agency. Enhanced Surface Water Treatment Rule (ESWTR) - 40 CFR Parts 9, 141 and 142, EPA, February 16, 1999.
- U.S. Environmental Protection Agency. Information Collection Rule (ICR) Microbial Laboratory Manual, EPA, April 1996.
- U.S. Environmental Protection Agency. Methods for Chemical Analysis of Water and Wastes, EPA 600/479-020, March, 1979.
- U.S. Environmental Protection Agency. Optimizing Water Treatment Plant Performance Using the Composite Correction Program. EPA/625/6-91/027, EPA1991b.
- U.S. Environmental Protection Agency. Partnership for Safe Drinking Water Web Page, EPA, July, 1999.
- U.S. Environmental Protection Agency. Surface Water Treatment Rule (SWTR) - 54 FR 27486 June 29, 1989, EPA1989b.
- U.S. Environmental Protection Agency /NSF International. ETV Protocol – Protocol for Equipment Verification Testing for Physical Removal of Microbiological and Particulate Contamination, EPA/NSF, April, 1998.
- U.S. Environmental Protection Agency /NSF International. ETV Protocol – Protocol for Equipment Verification Testing for Physical Removal of Microbiological and Particulate Contamination, EPA/NSF, February, 1999.