

US EPA ARCHIVE DOCUMENT

# Environmental Technology Verification Report

Physical Removal of Microbiological  
and Particulate Contaminants  
in Drinking Water

Hydranautics  
HYDRACap™ Ultrafiltration  
Membrane System  
Escondido, California

Prepared by



NSF International

Under a Cooperative Agreement with  
 U.S. Environmental Protection Agency

ET ✓ ET ✓ ET ✓

**THE ENVIRONMENTAL TECHNOLOGY VERIFICATION  
PROGRAM**



U.S. Environmental Protection Agency



NSF International

**ETV Joint Verification Statement**

TECHNOLOGY TYPE:	<b>MEMBRANE FILTRATION USED IN PACKAGED DRINKING WATER TREATMENT SYSTEMS</b>	
APPLICATION:	<b>PHYSICAL REMOVAL OF MICROBIOLOGICAL AND PARTICULATE CONTAMINANTS IN ESCONDIDO, CALIFORNIA</b>	
TECHNOLOGY NAME:	<b>HYDRACAP™ ULTRAFILTRATION MEMBRANE SYSTEM</b>	
COMPANY:	<b>HYDRANAUTICS</b>	
ADDRESS:	<b>401 JONES ROAD OCEANSIDE, CA 92054</b>	<b>PHONE: (760) 901 2500 FAX: (760) 901 2578</b>
WEB SITE:	<b><a href="http://www.membranes.com">http://www.membranes.com</a></b>	
EMAIL:	<b><a href="mailto:salt@hydranautics.com">salt@hydranautics.com</a></b>	

The U.S. Environmental Protection Agency (EPA) has created the Environmental Technology Verification (ETV) Program to facilitate the deployment of innovative or improved environmental technologies through performance verification and dissemination of information. The goal of the ETV program is to further environmental protection by substantially accelerating the acceptance and use of improved and more cost-effective technologies. ETV seeks to achieve this goal by providing high quality, peer reviewed data on technology performance to those involved in the design, distribution, permitting, purchase, and use of environmental technologies.

ETV works in partnership with recognized standards and testing organizations; stakeholders groups which consist of buyers, vendor organizations, and permittees; and with the full participation of individual technology developers. The program evaluates the performance of innovative technologies by developing test plans that are responsive to the needs of stakeholders, conducting field or laboratory tests (as appropriate), collecting and analyzing data, and preparing peer reviewed reports. All evaluations are conducted in accordance with rigorous quality assurance protocols to ensure that data of known and adequate quality are generated and that the results are defensible.

NSF International (NSF) in cooperation with the EPA operates the Drinking Water Treatment Systems (DWTS) Pilot, one of 12 technology areas under ETV. The DWTS Pilot recently evaluated the performance of an ultrafiltration membrane system used in package drinking water treatment system applications. This verification statement provides a summary of the test results for the Hydranautics HYDRACap™ Ultrafiltration Membrane System. Montgomery Watson, a NSF-qualified field testing organization (FTO), performed the verification testing.

**ABSTRACT**

Verification testing of the Hydranautics HYDRACap™ Ultrafiltration Membrane System (Hydranautics UF unit) was conducted over two test periods at the Aqua 2000 Research Center in San Diego, California. The first test period, from August 3, 1999 to September 13, 1999 represented summer/fall conditions. The second test period, from February 16, 2000 to March 21, 2000 represented winter/spring conditions. The source water was a blend of Colorado River and State Project Water. Verification testing was conducted at manufacturer specified operating conditions. The membrane unit was operated in dead-end mode at a constant flux of 69 gfd (115 L/hr-m<sup>2</sup>) with feedwater recoveries ranging from 85 to 87 percent. During Test Period 1, membrane fouling due to algae bloom was observed near the beginning of the operating period. The system completed all of Test Period 2 without appreciable loss of specific flux. The manufacturer recommended cleaning procedure was effective in recovering membrane productivity. The membrane system achieved significant removal of particulate contaminants and bacteria and seeded MS2 bacteriophage (described later).

**TECHNOLOGY DESCRIPTION**

The Hydranautics test unit is comprised of two HYDRACap™ hollow fiber UF membrane modules mounted on a transportable skid constructed of steel. The test unit can be shipped by truck. The Hydranautics UF unit is completely self-contained, including all the components required for operation. The only connections required are a raw water connection to the feed pump, drain lines for filtrate tank overflow and backwash waste, and electrical power. The unit requires approximately 32 ft<sup>2</sup> (3.0 m<sup>2</sup>) of floor space.

The test unit has an Allen Bradley programmable logic controller (PLC). The PLC controls the opening and closing of pneumatic valves and the operation of pumps required for filtration and backwash. The backwash frequency and the length of time the system spends in each backwash phase are set by entering values into the appropriate screen on the PLC. The PLC does not maintain a constant filtrate flow during filtration, instead this is set manually by making adjustments to feed pump speed and filtrate valve setting. The test unit has analog flow, pressure and temperature measurement. It did not include a data logger to acquire operating information digitally.

The Hydranautics UF unit has two alternating operating modes. These are filtration and backwash. During filtration, raw water is driven under pressure through pores in the UF membrane. Treated water is collected from the filtrate side of the membrane. At the end of the filtration cycle, the system initiates a backwash. During backwash, the feed pump shuts down, valves are repositioned, and the backwash pump starts. The backwash pump draws treated water from the filtrate storage tank, chlorinates it, and forces the water under pressure in the reverse direction through the fibers. With the flow of water now from the outside of the fiber to the inside of the fiber, the backwash water exits the inside of the fibers at the fiber ends, carrying with it particulate material accumulated during filtration. Chlorine is added to the backwash water and assists in oxidizing organics that have accumulated on the membrane surface. The long-term operation of the unit frequently results in the accumulation of materials on the membrane surface which are not effectively removed by backwash. This is called membrane fouling and is quantified by a gradual increase in the pressure required to maintain the desired flux. Once a critical upper pressure has been reached, normal operation is discontinued and the membrane undergoes chemical cleaning. Chemical cleaning involves the use of citric acid and caustic solutions to restore efficient operation of the membrane.

The Hydranautics UF unit has two HYDRACap™ membrane modules. These 8 inch (20 cm) diameter modules each contain 10,000 fibers. The HYDRACap™ is a hollow fiber configuration, manufactured from polyether sulfone, with nominal molecular weight cut-off of 150,000 to 180,000 Daltons. This

corresponds with a pore diameter of approximately 0.015 to 0.018 micron. At this pore size, the HYDRACap™ is expected to remove particulates, including protozoa, bacteria and virus.

## VERIFICATION TESTING DESCRIPTION

### *Test Site*

The verification test site was the City of San Diego's Aqua 2000 Research Center at 14103 Highland Valley Road in Escondido, California. The Research Center includes office and lab trailers, a covered concrete test pad and a dedicated operations staff with substantial membrane experience. The source water for testing was Lake Skinner water via the San Diego Aqueduct. Lake Skinner water consists of Colorado River water and State Project water, which are two of the major raw drinking water supplies in Southern California.

### *Methods and Procedures*

Turbidity, pH, chlorine and temperature analyses were conducted daily at the test site according to Standard Methods for the Examination of Water and Wastewater, 19<sup>th</sup> Ed. (APHA, et. al., 1995). Standard Methods, 19<sup>th</sup> Ed. (APHA, 1995) and Methods for Chemical Analysis of Water and Wastes (EPA, 1979) were used for analyses conducted at The City of San Diego Laboratory. These included alkalinity, total and calcium hardness, total dissolved solids (TDS), total suspended solids (TSS), total organic carbon (TOC), ultraviolet absorbance at 254 nanometers (UV254), total coliform and heterotrophic plate count (HPC). Total and calcium hardness analyses were conducted every other week. All other analyses were conducted weekly. MS2 bacteriophage analysis was conducted by EPA ICR Method for Coliphage Analysis (Sobsey, et al. 1990). On-line Hach 1900 WPC particle counters and 1720D turbidimeters continuously monitored these parameters in both the raw water and membrane system filtrate. The particle counters were set up to enumerate particle counts in the following size ranges: 2-3 um, 3-5 um, 5-15 um, and > 15 um. Data from the on-line particle counters and turbidimeters were stored at 1-minute intervals on a computer.

## VERIFICATION OF PERFORMANCE

### *System Operation*

Verification testing was conducted at manufacturer specified operating conditions. The membrane unit was operated at a constant flux of 69 gfd (115 L/hr-m<sup>2</sup>) with feedwater recoveries ranging from 85 to 87 percent. Filtrate flow rate was set manually by adjusting the feed pump speed and the filtrate valve to achieve the desired flow at a feed pressure of 20 psi (1.4 bar). Backwash frequency was every 19 minutes. Backwash volume averaged 30 gallons (114 liter) for Test Period 1 and 25 gallons (95 liter) for Test Period 2. Backwash chlorine concentration was in the range 10 to 15 mg/L for the first run of Test Period 1 and was increased to 15 to 20 mg/L for the remainder of testing. The system initially ran for 9 days in Test Period 1 with a decrease in specific flux from 16 to 3 gfd/psi (390 to 75 L/hr-m<sup>2</sup>). This rapid fouling was likely due to an algae bloom in the source water. Cleaning recovered specific flux to approximately 13 gfd/psi (320 L/hr-m<sup>2</sup>). After cleaning, the unit fouled slightly overnight but then gradually recovered specific flux over the remainder of Test Period 1 as the algae bloom subsided. The system ran all of Test Period 2 without requiring a cleaning. The system fouled rapidly over the first eight days of operation at the beginning of Test Period 2. Specific flux decreased from 15 gfd/psi (370 L/hr-m<sup>2</sup>) to 5 gfd/psi (120 L/hr-m<sup>2</sup>). After this, repairs were made to the backwash chlorine feed pump, and the system recovered over the remainder Test Period 2 to a specific flux of 9 gfd/psi (220 L/hr-m<sup>2</sup>).

Membrane cleaning was performed according to manufacturer recommended procedure. Citric acid and caustic cleaning solutions were prepared in the filtrate storage tank and recirculated through the feed side of the membrane at approximately 4 gpm (15 L/min) for 60 minutes. Flux-pressure profiles were

performed after each cleaning step to evaluate recovery of specific flux. The manufacturer recommended cleaning procedure was effective in recovering specific flux. Loss of original flux was 10 percent after the first cleaning in Test Period 1 and decreased to 8 percent after the second cleaning in Test Period 1. Specific flux was recovered to new membrane conditions on cleaning at the end of Test Period 2.

Air pressure-hold tests were conducted near the beginning and end of each test period to assess membrane integrity. Air pressure-hold tests were conducted by opening the filtrate side of the membrane to atmosphere and pressurizing the feed side of the membrane. Once pressurized, the loss of held pressure on the filtrate side was monitored over 10 minutes. All air pressure-hold tests had minimal loss (< 1 psi every 5 minutes) of held pressure, indicating the membranes were intact during both test periods.

**Source Water**

The source water for the ETV testing consisted of a blend of Colorado River water and State Project water delivered to the test site via the San Diego Aqueduct. The source water had the following average water quality during the two test periods: TDS 500/480 mg/L, hardness 250/220 mg/L as CaCO<sub>3</sub>, alkalinity 120/120 mg/L as CaCO<sub>3</sub>, TOC 3.3/3.3 mg/L, pH 8.2/8.2, temperature 30/17 and turbidity 1.4/1.3 NTU.

**Particle Removal**

Total suspended solids in the filtrate were removed to below the detection limit for the analysis (1 mg/L), for all samples analyzed. Filtrate turbidity was 0.05 NTU or less 95 percent of the time. The test system removed greater than 2 logs of both Cryptosporidium-sized (3-5 um) particles and Giardia-sized (5-15 um) particles, 95 percent of the time. Four hour average raw water and filtrate particle levels and daily average particle removal in these size ranges for Test Periods 1 and 2 are presented in the following table:

<b>Hydranautics HYDRACap™ UF System Particle Counts and Particle Removals for Test Periods 1/2</b>						
	3-5 um Particles			5-15 um Particles		
	Raw Water (#/mL)	Filtrate (#/mL)	Log Removal	Raw Water (#/mL)	Filtrate (#/mL)	Log Removal
Average	2500/1700	4.0/0.35	3.0/3.7	1400/870	4.2/0.30	2.7/3.5
Standard Deviation	690/300	9.4/0.70	0.35/0.30	410/240	9.2/0.60	0.40/0.30
95% Confidence Interval	2400-2600/ 1700-1700	2.8-5.2/ 0.25-0.45	2.9-3.1/ 3.6-3.8	1300-1500/ 840-900	3.0-5.4/ 0.21-0.39	2.6-2.8/ 3.4-3.6
Minimum	890/1200	0.60/0.15	1.6/2.5	410/520	0.65/0.10	1.4/2.3
Maximum	4000/2700	110/9.3	3.4/4.0	2300/2500	100/7.9	3.2/3.8

**Microbial Removal**

Total Coliforms and HPC were analyzed on a weekly basis during both ETV test periods. Raw water total coliforms averaged 7 MPN/100mL during both Test Periods 1 and 2. No total coliform were detected in the filtrate. HPC were significantly reduced. HPC averaged 443 and 82 cfu/mL in the raw water for Test Periods 1 and 2 while filtrate levels of HPC averaged 2 and 1 cfu/mL, respectively. Seedings with MS2 bacteriophage were conducted at the beginning of each Test Period, immediately after membrane cleaning (worst case for virus removal). Virus were continuously added to the membrane feed water. The membrane was allowed to operate for 1 filtration cycle to come to equilibrium and then paired samples were taken from the feed and filtrate within 1-minute of completion of backwash, at the middle and at the end of the filtration cycle, over the next two filtration cycles. Specific flux during the seeding conducted at the beginning of Test Period 1 was 15 gfd/psi (360 L/hr-m<sup>2</sup>-bar), while specific flux for the seeding conducted at the beginning of Test Period 2 was 16 gfd/psi (400 L/hr-m<sup>2</sup>-bar). Feed virus concentration ranged from 2.8 x 10<sup>7</sup> to 1.7 x 10<sup>8</sup> plaque forming units/100mL (pfu/100mL) for the first virus seeding and from 4.5 x 10<sup>7</sup> to 1.1 x 10<sup>8</sup> pfu/100mL for the second virus seeding. Log removal of virus ranged from 3.9 to 4.7 for Test Period 1 and from 3.4 to 4.3 for Test Period 2.



**Operation and Maintenance Results**

Operation was initiated by entering backwash frequency in the appropriate PLC screen. Backwash times were entered on the appropriate PLC screen. Backwash flow rate was adjusted manually using a valve. Filtrate flow rate was adjusted by manually setting feed pump speed and throttling the filtrate valve. As the membrane system fouled, the feed pump speed required manual readjustment to maintain a constant filtrate flow rate. The sodium hypochlorite dosing pump required initial manual adjustment to achieve a target chlorine dose in the backwash water of 15 to 20 mg/L. Chlorine concentration in the backwash feedwater was checked twice daily.

Operation of the membrane unit consumed 0.36 gal (1.4 L) of 10% sodium hypochlorite per day to chlorinate backwash water. No other chemicals were consumed during routine operation of the system. During a typical chemical cleaning, 4.0 pounds (1.8 kg) of citric acid, 0.29 gallon (1.1 liter) of caustic soda and 200 milliliters of muriatic acid (40% hydrochloric acid) were consumed. The manufacturer supplied an Operations and Maintenance manual that was helpful in explaining the setup, operation and maintenance of the ETV test system.

<p><i>Original Signed by</i> <u>E. Timothy Oppelt</u></p>	<p>9/28/00</p>	<p><i>Original Signed by</i> <u>Tom Bruursema</u></p>	<p>10/17/00</p>
<p>E. Timothy Oppelt Director National Risk Management Research Laboratory Office of Research and Development United States Environmental Protection Agency</p>	<p>Date</p>	<p>Tom Bruursema General Manager Environmental and Research Services NSF International</p>	<p>Date</p>

NOTICE: Verifications are based on an evaluation of technology performance under specific, predetermined criteria and the appropriate quality assurance procedures. EPA and NSF make no expressed or implied warranties as to the performance of the technology and do not certify that a technology will always operate as verified. The end user is solely responsible for complying with any and all applicable federal, state, and local requirements. Mention of corporate names, trade names, or commercial products does not constitute endorsement or recommendation for use of specific products. This report is not a NSF Certification of the specific product mentioned herein.

**Availability of Supporting Documents**

Copies of the *ETV Protocol for Equipment Verification Testing for Physical Removal of Microbiological and Particulate Contaminants*, dated April 20, 1998 and revised May 14, 1999, the Verification Statement, and the Verification Report (NSF Report #00/04/EPADW395) are available from the following sources:

(NOTE: Appendices are not included in the Verification Report. Appendices are available from NSF upon request.)

1. Drinking Water Treatment Systems ETV Pilot Manager (order hard copy)  
NSF International  
P.O. Box 130140  
Ann Arbor, Michigan 48113-0140
2. NSF web site: <http://www.nsf.org/etv> (electronic copy)
3. EPA web site: <http://www.epa.gov/etv> (electronic copy)

September 2000

## **Environmental Technology Verification Report**

### **Physical Removal of Microbiological and Particulate Contaminants in Drinking Water**

#### **Hydranautics HYDRACap™ Ultrafiltration Membrane System Escondido, California**

Prepared for:

NSF International  
Ann Arbor, MI 48105

Prepared by:

Samer Adham, Ph.D.  
&  
Karl Gramith

Montgomery Watson  
Pasadena, CA 91101

Under a cooperative agreement with the U.S. Environmental Protection Agency

Jeffrey Q. Adams, Project Officer  
National Risk Management Research Laboratory  
U.S. Environmental Protection Agency  
Cincinnati, Ohio 45268



## Notice

The U.S. Environmental Protection Agency (EPA) through its Office of Research and Development has financially supported and collaborated with NSF International (NSF) under Cooperative Agreement No. CR 824815. This verification effort was supported by Drinking Water Treatment Systems Pilot operating under the Environmental Technology Verification (ETV) Program. This document has been peer reviewed and reviewed by NSF and EPA and recommended for public release.

## Foreword

The following is the final report on an Environmental Technology Verification (ETV) test performed for the NSF International (NSF) and the United States Environmental Protection Agency (EPA) by Montgomery Watson, in cooperation with Hydranautics. The test was conducted in 1999 and 2000 at the Aqua 2000 Research Center in San Diego, California.

Throughout its history, the EPA has evaluated the effectiveness of innovative technologies to protect human health and the environment. The ETV Program has been instituted to verify the performance of innovative technical solutions to environmental pollution or human health threats. ETV was created to substantially accelerate the entrance of new environmental technologies into the domestic and international marketplace. Verifiable, high quality data on the performance of new technologies are made available to regulators, developers, consulting engineers, and those in the public health and environmental protection industries. This encourages more rapid availability of approaches to better protect the environment.

The EPA has partnered with NSF, an independent, not-for-profit testing and certification organization dedicated to public health, safety and protection of the environment, to verify performance of small package drinking water systems that serve small communities under the Drinking Water Treatment Systems (DWTS) ETV Pilot. A goal of verification testing is to enhance and facilitate the acceptance of small package drinking water treatment equipment by state drinking water regulatory officials and consulting engineers while reducing the need for testing of equipment at each location where the equipment's use is contemplated. NSF will meet this goal by working with manufacturers and NSF-qualified Field Testing Organizations (FTO) to conduct verification testing under the approved protocols.

NSF is conducting the DWTS ETV with participation of manufacturers, under the sponsorship of the EPA Office of Research and Development, National Risk Management Research Laboratory, Water Supply and Water Resources Division, Cincinnati, Ohio. It is important to note that verification of the equipment does not mean that the equipment is "certified" by NSF or "accepted" by EPA. Rather, it recognizes that the performance of the equipment has been determined and verified by these organizations for those conditions tested by the FTO.

## Table of Contents

<u>Section</u>	<u>Page</u>
Verification Statement.....	VS-i
Title Page.....	i
Notice .....	ii
Foreword.....	iii
Table of Contents .....	iv
List of Tables .....	vii
List of Figures .....	viii
Abbreviations and Acronyms.....	ix
Acknowledgements .....	x
<b>Chapter 1 - Introduction.....</b>	<b>1</b>
1.1 Environmental Technology Verification (ETV) Purpose and Program Operation .....	1
1.2 Project Participants .....	1
1.3 Definition of Roles and Responsibilities of Project Participants .....	2
1.3.1 Field Testing Organization Responsibilities.....	2
1.3.2 Manufacturer Responsibilities .....	2
1.3.3 Operator and Test Site Staff Responsibilities .....	2
1.3.4 Water Quality Analyst Responsibilities .....	2
1.3.5 NSF Responsibilities .....	3
1.3.6 EPA Responsibilities .....	3
<b>Chapter 2 - Equipment Description and Operating Processes .....</b>	<b>4</b>
2.1 Description of the Treatment Train and Unit Processes .....	5
2.2 Description of Physical Construction/Components of the Equipment .....	7
<b>Chapter 3 - Materials and Methods.....</b>	<b>8</b>
3.1 Testing Site Name and Location.....	8
3.1.1 Site Background Information.....	8
3.1.2 Test Site Description .....	8
3.2 Source/Feed Water Quality .....	9
3.3 Environmental Technology Verification Testing Plan .....	10
3.3.1 Task 1: Characterization of Membrane Flux and Recovery .....	10
3.3.2 Task 2: Evaluation of Cleaning Efficiency.....	10

**Table of Contents, continued**

<u>Section</u>	<u>Page</u>
3.3.3 Task 3: Evaluation of Finished Water Quality.....	12
3.3.4 Task 4: Reporting of Membrane Pore Size.....	12
3.3.5 Task 5: Membrane Integrity Testing .....	12
3.3.6 Task 6: Data Management .....	13
3.3.7 Task 7: Quality Assurance/Quality Control.....	13
3.3.8 Task 8: Microbial Removal (Optional) .....	17
3.4 Calculation of Membrane Operating Parameters .....	18
3.4.1 Filtrate Flux.....	18
3.4.2 Specific Flux .....	18
3.4.3 Transmembrane Pressure.....	18
3.4.4 Temperature Adjustment for Flux Calculation .....	18
3.4.5 Feedwater System Recovery.....	19
3.4.6 Rejection.....	19
3.5 Calculation of Data Quality Indicators .....	19
3.5.1 Precision .....	19
3.5.2 Relative Percent Deviation .....	19
3.5.3 Accuracy .....	20
3.5.4 Statistical Uncertainty .....	20
3.6 Testing Schedule.....	20
<b>Chapter 4 - Results and Discussion.....</b>	<b>21</b>
4.1 Task 1: Characterization of Membrane Flux and Recovery.....	21
4.2 Task 2: Evaluation of Cleaning Efficiency .....	22
4.3 Task 3: Evaluation of Finished Water Quality .....	23
4.3.1 Turbidity, Particle Concentration and Particle Removal.....	23
4.3.2 Indigenous Bacteria Removal .....	24
4.3.3 Other Water Quality Parameters .....	24
4.4 Task 4: Reporting Membrane Pore Size .....	24
4.5 Task 5: Membrane Integrity Testing.....	25
4.6 Task 6: Data Management.....	25
4.6.1 Data Recording.....	25
4.6.2 Data Entry, Validation, and Reduction.....	25

## Table of Contents, continued

<u>Section</u>	<u>Page</u>
4.7 Task 7: Quality Assurance/Quality Control (QA/QC).....	25
4.7.1 Data Correctness .....	25
4.7.2 Statistical Uncertainty .....	26
4.7.3 Completeness .....	26
4.7.4 Accuracy .....	26
4.7.5 Precision and Relative Percent Deviation.....	26
4.8 Task 8: Microbial Removal.....	27
4.9 Additional ETV Program Requirements.....	27
4.9.1 Operation and Maintenance (O&M) Manual.....	27
4.9.2 System Efficiency and Chemical Consumption.....	27
4.9.3 Equipment Deficiencies Experienced During the ETV Program .....	28
4.10 Inspection .....	28
<b>Chapter 5 References .....</b>	<b>29</b>

### Appendices

Appendix A – Additional Documents and Data Analyses

Appendix B – Raw Data Sheets

Appendix C – Hardcopy Electronic Data

**List of Tables**

Table 2-1. Characteristics of the Hydranautics ultrafiltration membrane. .... 31

Table 3-1. Water quality analytical methods. .... 32

Table 4-1. Hydranautics UF membrane system operating conditions. .... 33

Table 4-2. Evaluation of cleaning efficiency for the Hydranautics UF membrane. .... 33

Table 4-3. Onsite lab water quality analyses for the Hydranautics UF membrane system. .... 34

Table 4-4. Summary of on-line particle and turbidity data for the Hydranautics UF membrane system. .... 35

Table 4-5. Summary of the microbial water quality analyses for the Hydranautics UF membrane system. .... 36

Table 4-6. Summary of general water quality analyses for the Hydranautics UF membrane system. .... 37

Table 4-7. Comparison of calculated and measured total suspended solids for the Hydranautics UF membrane system. .... 38

Table 4-8. Feed and filtrate concentrations of MS2 virus for the Hydranautics UF membrane system. .... 39

Table 4-9. Review of manufacturer’s operations and maintenance manual for the Hydranautics UF membrane system. .... 40

Table 4-10. Efficiency of Hydranautics UF membrane system. .... 41

Table 4-11. Chemical consumption for the Hydranautics UF membrane system. .... 42



## List of Figures

Figure 1-1. Organizational chart showing lines of communication. ....	43
Figure 2-1. Photograph of the ETV test unit.....	43
Figure 2-2. Spatial requirements for the Hydranautics UF unit.....	44
Figure 2-3. Schematic diagram of the Hydranautics UF membrane process. ....	45
Figure 3-1. Schematic of Aqua 2000 Research Center test site.....	45
Figure 3-2. Lake Skinner raw water quality. ....	46
Figure 3-3. Lake Skinner raw water quality. ....	47
Figure 3-4. Response of on-line particle counters to Duke Monosphere Solution. ....	48
Figure 3-5. Membrane verification testing schedule.....	49
Figure 4-1. Transmembrane pressure and temperature profiles for the Hydranautics UF membrane system.....	50
Figure 4-2. Operational flux and specific flux profiles for the Hydranautics UF membrane system.....	51
Figure 4-3. Clean water flux profile during membrane chemical cleanings – Test Period 1.....	52
Figure 4-4. Clean water flux profile during membrane chemical cleanings – Test Period 2.....	54
Figure 4-5. Turbidity profile for raw water and Hydranautics UF membrane system – Test Period 1.....	55
Figure 4-6. Turbidity profile for raw water and Hydranautics UF membrane system – Test Period 2.....	55
Figure 4-7. Particle count profile for raw water and Hydranautics UF system filtrate – Test Period 1.....	56
Figure 4-8. Particle count profile for raw water and Hydranautics UF system filtrate – Test Period 2.....	57
Figure 4-9. Particle removal for the Hydranautics UF system – Test Period 1.....	58
Figure 4-10. Particle removal for the Hydranautics UF system – Test Period 2.....	59
Figure 4-11. Probability plots of filtrate turbidity and log removal of particles for the Hydranautics UF membrane system. ....	60
Figure 4-12. Air pressure hold test results for the Hydranautics UF membrane system.....	61
Figure 4-13. Log removal of seeded MS2 virus by Hydranautics UF membrane system.....	62

## Abbreviations and Acronyms

°C	Celsius degrees	mg/L	Milligram(s) per liter
CDHS	California Department of Health Services	min	Minute(s)
cfu	Colony forming unit(s)	mL	Milliliter(s)
CIP	Clean in place	MPN	Most probable number
C <sub>f</sub>	Feed concentration	NIST	National Institute of Standards and Technology
C <sub>p</sub>	Filtrate concentration	NSF	NSF International
cm	Centimeter	NTU	Nephelometric turbidity unit(s)
CRW	Colorado River water	O&M	Operations and Maintenance
d	Day(s)	P <sub>i</sub>	Pressure at inlet of membrane module
DBP	Disinfection by-product	P <sub>o</sub>	Pressure at outlet of membrane module
DOC	Dissolved organics carbon	P <sub>p</sub>	Filtrate pressure
DWTS	Drinking Water Treatment System	P <sub>tm</sub>	Transmembrane pressure
EPA	U.S. Environmental Protection Agency	PC	Personal computer
ETV	Environmental Technology Verification	pfu	Plaque forming unit(s)
FOD	Field Operations Document	PLC	Programmable logic Controller
ft <sup>2</sup>	Square foot (feet)	ppm	Parts per million
FTO	Field Testing Organization	psi	Pound(s) per square inch
gfd	Gallon(s) per day per square foot of membrane area	PVC	Polyvinyl chloride
gpm	Gallon(s) per minute	Q <sub>f</sub>	Feed flow
HPC	Heterotrophic plate count bacteria	Q <sub>p</sub>	Filtrate flow
hr	Hour(s)	Q <sub>r</sub>	Recycle flow
ICR	Information Collection Rule	QA	Quality assurance
in Hg	Inch(es) of Mercury	QC	Quality control
J <sub>t</sub>	Filtrate flux	S	Membrane surface area
J <sub>tm</sub>	Transmembrane flux	SDS	Simulated distribution system
J <sub>si</sub>	Initial specific transmembrane flux	scfm	Standard cubic feet per minute
J <sub>sf</sub>	Final specific transmembrane flux	sec	Second(s)
J <sub>s</sub>	Specific flux	SPW	State Project water
J <sub>si0</sub>	Initial specific transmembrane flux at t=0 of membrane operation	T	Temperature
kg	Kilogram(s)	TC	Total coliform bacteria
L	Liter(s)	TOC	Total organic carbon
m <sup>2</sup>	Square meter(s)	TDS	Total dissolved solids
m <sup>3</sup> /d	Cubic meter(s) per day	TSS	Total suspended solids
mgd	Million gallons per day	um	Micron(s)
		UF	Ultrafiltration
		UFC	Uniform formation conditions
		UV254	Ultraviolet light absorbance at 254 nanometer

## Acknowledgements

The authors would like to thank the EPA, for sponsoring the ETV Program and providing partial funding for the study. In particular, the authors would like to thank Jeffrey Q. Adams, Project Officer with the EPA, for his continuous support throughout the project.

The authors would also like to thank NSF, for administrating the ETV program. The time and continuous guidance provided by the following NSF personnel is gratefully acknowledged: Bruce Bartley, Carol Becker, and Kristie Wilhelm.

The time and outstanding efforts provided by the manager of Aqua 2000 Research Center, Paul Gagliardo with the City of San Diego is gratefully acknowledged. The authors would also like to thank Jeff Williams from the Aqua 2000 Center operation team for his assistance in operating the membrane system. The authors would also like to thank Dana Chapin from the City of San Diego Water Laboratory for facilitating most of the water quality analyses in the study. In addition, the authors would like to thank Yildiz Chambers from the City of San Diego Marine Microbiology Laboratory for coordinating the microbial analyses in the study.

The author would also like to acknowledge the manufacturer of the equipment employed during the ETV Program (Hydranautics, Oceanside, CA) for their continuous assistance throughout the ETV test operation periods and for providing partial funding to the project. In particular, the authors would like to thank Mark Wilf and Steve Alt from Hydranautics for their continuous support.

The authors gratefully acknowledge the contributions of the following co-workers from Montgomery Watson: Anthony Huang, Rion Merlo, Lina Boulos, Natalie Flores, and Rene Lucero.

## Chapter 1 Introduction

### 1.1 Environmental Technology Verification (ETV) Purpose and Program Operation

The U.S. Environmental Protection Agency (EPA) has created the ETV Program to facilitate the deployment of innovative or improved environmental technologies through performance verification and dissemination of information. The goal of the ETV program is to further environmental protection by substantially accelerating the acceptance and use of improved and more cost-effective technologies. ETV seeks to achieve this goal by providing high quality, peer reviewed data on technology performance to those involved in the design, distribution, permitting, purchase, and use of environmental technologies.

ETV works in partnership with recognized standards and testing organizations; stakeholders groups which consist of buyers, vendor organizations, and permittees; and with the full participation of individual technology developers. The program evaluates the performance of innovative technologies by developing test plans that are responsive to the needs of stakeholders, conducting field or laboratory testing (as appropriate), collecting and analyzing data, and preparing peer reviewed reports. All evaluations are conducted in accordance with rigorous quality assurance protocols to ensure that data of known and adequate quality are generated and that the results are defensible.

NSF International (NSF) in cooperation with the EPA operates the Drinking Water Treatment Systems (DWTS) Pilot, one of 12 technology areas under ETV. This DWTS Pilot evaluated the performance the Hydranautics HYDRACap™ ultrafiltration (UF) system used in package drinking water treatment system applications.

This report provides the ETV results of Hydranautics HYDRACap™ UF system.

### 1.2 Project Participants

Figure 1-1 is an organization chart showing the project participants and the lines of communication established for the ETV. The Field Testing Organization (FTO) was Montgomery Watson, a NSF-qualified FTO, which provided the overall management of the ETV through the project manager and project engineer. The ultrafiltration membrane manufacturer for the ETV was Hydranautics. The operations management and staff were from the test site at the City of San Diego Metropolitan Wastewater Department, Aqua 2000 Research Center in Escondido, California. The City of San Diego laboratory, a State-certified laboratory, provided water quality analyses. Data management and final report preparation were performed by the FTO, Montgomery Watson.

### **1.3 Definition of Roles and Responsibilities of Project Participants**

#### ***1.3.1 Field Testing Organization Responsibilities***

The specific responsibilities of the FTO, Montgomery Watson, were to:

- Provide the overall management of the ETV through the project manager and the project engineers.
- Provide all needed logistical support, the project communication network, and all scheduling and coordination of the activities of all participants.
- Manage, evaluate, interpret and report on data generated in the ETV.
- Evaluate the performance of the ultrafiltration membrane technology according to the Field Operating Document (FOD) and the testing, operations, quality assurance/quality control (QA/QC), data management and safety protocols contained therein.
- Provide all quality control (QC) information in the ETV report.
- Provide all data generated during the ETV in hard copy and electronic form in a common spreadsheet or database format.

#### ***1.3.2 Manufacturer Responsibilities***

The specific responsibilities of the ultrafiltration membrane manufacturer, Hydranautics, were to:

- Provide complete, field-ready equipment for the ETV at the testing site.
- Provide logistical and technical support as required throughout the ETV.
- Provide partial funding for the project.
- Attend project meetings as necessary.

#### ***1.3.3 Operator and Test Site Staff Responsibilities***

The specific responsibilities of the operations and test site staff from the City of San Diego Metropolitan Wastewater Department were to:

- Provide set-up, shake-down, operations, maintenance and on-site analytical services according to the FOD and the testing, operations, QA/QC, data management and safety protocols.
- Provide the necessary and appropriate space for the equipment to be tested in the ETV.
- Provide all necessary electrical power, feedwater and other utilities as required for the ETV.
- Provide all necessary drains to the test site.

#### ***1.3.4 Water Quality Analyst Responsibilities***

The specific responsibilities of the water quality analytical staff from the City of San Diego Laboratory were to:

- Provide all off-site water quality analyses prescribed in the FOD according to the QA/QC protocols contained therein.

- Provide reports with the analytical results to the data manager.
- Provide detailed information on the analytical procedures implemented.

### ***1.3.5 NSF Responsibilities***

NSF was responsible for administration of the testing program. Specific responsibilities of NSF were to:

- Develop test protocols and qualify FTOs.
- Review and approve FODs.
- Conduct inspections and make recommendations based on inspections.
- Conduct financial administration of the project.
- Review all project reports and deliverables.

### ***1.3.6 EPA Responsibilities***

The specific responsibilities of the EPA were to:

- Initiate the ETV program.
- Provide significant project funding.
- Review final reports.



## Chapter 2 Equipment Description and Operating Processes

The equipment tested in the ETV is Hydranautics ultrafiltration membrane system. The test unit is comprised of two horizontally mounted HYDRACap™ hollow fiber UF membrane modules on a transportable skid. The skid is constructed of steel, and can be shipped by truck. A photograph of the test unit is shown in Figures 2-1. The skid includes all major equipment elements and controls and requires only approximately 32 ft<sup>2</sup> (3.0 m<sup>2</sup>) of floor space. The spatial requirements and locations of major components and instruments of the Hydranautics UF unit are shown in Figure 2-2.

The Hydranautics UF unit is completely self-contained, including all the components required for operation. The only connections to the test unit are a raw water connection to the feed pump, drain lines for filtrate tank overflow and backwash waste, and electrical power.

The test unit includes an Allen Bradley programmable logic controller (PLC). Operating parameters such as backwash frequency, time spent in each backwash phase and chemical dosing during backwash are set using the PLC. The PLC automatically controls pumps and valves during backwash. Feed pump speed is adjusted manually to control filtrate flow rate.

The Hydranautics UF unit has two alternating operating modes: filtration and backwash. During filtration, after prefiltration to 300 um, raw water is driven under pressure from the feed side of the hollow fibers (inside of fibers), through pores in the UF membrane. Treated water is collected from the filtrate side of the membrane (outside of fibers). The filtration cycle typically lasts from 10 to 30 minutes. At the end of the filtration cycle, the system initiates a backwash. During backwash, the feed pump shuts down, valves are repositioned, and the backwash pump starts. The backwash pump draws treated water from the filtrate storage tank, chlorinates it, and forces the water under pressure in the reverse direction through the fibers. With the flow of water now from the outside of the fiber to the inside of the fiber, the backwash water exits the inside of the fibers at the fiber ends, carrying with it particulate material accumulated during filtration. Chlorine added to the backwash water assists in oxidizing organics that have accumulated on the membrane surface. The backwash cycle typically lasts from 45 to 90 seconds, after which the unit returns to filtration mode. Filtrate and backwash waste streams were directed to drain during ETV testing.

The long-term operation of the test unit frequently results in the accumulation of materials on the membrane surface which are not effectively removed by backwash. This is called membrane fouling and is quantified by a gradual increase in the pressure required to force water through the membrane pores. Once a critical upper pressure has been reached, normal operation is discontinued and the membrane undergoes chemical cleaning. Chemical cleaning involves the use of acid and caustic solutions to restore efficient operation of the membrane.

Table 2-1 provides the specification of the Hydranautics HYDRACap™ UF membranes. The information in Table 2-1 is taken from a letter supplied by the manufacturer (see Appendix A). The Hydranautics UF unit has two HYDRACap™ membrane modules. Only one of these

modules was used during ETV testing. The HYDRACap™ is a hollow-fiber, inside-out configuration membrane with nominal molecular weight cut-off of approximately 150,000 to 180,000 Daltons. This corresponds with a pore diameter of approximately 0.015 to 0.018 micron. At this pore size, the HYDRACap™ membrane is expected to remove particulate material, including protozoa, bacteria and virus.

## 2.1 Description of the Treatment Train and Unit Processes

Figure 2-3 presents a schematic diagram of the Hydranautics UF system. The test system has two alternating operation modes: filtration and backwash.

The operation of the UF membrane system is summarized in the following steps:

1. Before the feed pump, the water passes through a pre-filter. Pre-filtration at 300 microns ensures the removal of large particles prior to the feed flow entering the modules in order to protect the heads of the modules from clogging.
2. The feed pump then provides the pressure needed to filter the water through the membranes (up to approximately 20 psi or 1.4 bars). Feed pump speed and filtrate valve are adjusted manually to achieve the desired filtrate flow and feed pressure. The system was run with a constant feed pressure of 20 psi (1.4 bar) and variable filtrate pressure to achieve the desired filtrate flow rate.
3. The feedwater continues to the membrane module where it is directed to the UF module end. At the module end, raw water enters the inside of the fibers and is forced, under pressure, to the outside, or filtrate side, of the membrane.
4. The filtrate water exits the module through a filtrate tube running through the center of the module and is collected in a 100 gallon (379 L) filtrate tank. Overflow from this tank is directed to drain. The modules filter on a cycle of 10 to 30 minutes between backwashes.
5. Backwash is initiated automatically based on a timer. The objective of the backwash is to remove solids and organics which have accumulated on the feed side of the membrane during filtration. A PLC automatically operates pumps and valves to accomplish a backwash.
6. The backwash cycle was made up of 5 steps as described below:
  - 6.1. Forward Flush. During forward flush, feed water is pumped through the feed side of the membrane (inside of fibers) and wasted from the concentrate side, without filtrate flow. This removes the bulk of solids accumulated on the feed side of the membrane. This step lasts approximately 10 seconds.
  - 6.2. Backwash Feed Only. During this backwash phase, filtrate from the filtrate storage tank is pumped under pressure in the reverse direction through the membrane and exits the module end at the feed side of the module. The backwash feed water is chlorinated. This reverse flow is at 25 psi (1.7 bars) at a rate of approximately 35 to 45 gpm (130 to 170 L/min). This step lasts approximately 12 seconds.
  - 6.3. Backwash Concentrate Only. This backwash phase is identical to the previous phase, only the backwash waste exits the concentrate side of the module. This step also lasts approximately 12 seconds.
  - 6.4. Soak. The soak phase allows the membrane to relax while it is exposed chlorinated filtrate water. Typically this phase lasts 15 to 20 seconds.

6.5. Rinse Both Sides: During the rinse phase, contaminants transferred to the soak water are rinsed out of the feed and concentrate side of the module before the membrane returns to filtration mode.

Overall, the backwash typically lasts from 45 to 90 seconds. Waste from the backwash cycle is routed to drain.

7. At the completion of backwash, the PLC stops the backwash pump, readjusts the appropriate valves and restarts the system in filtration mode.

The Hydranautics UF system was operated in dead-end filtration mode throughout the Hydranautics UF ETV testing. In dead-end, or direct-flow mode the feed pump directs raw water to the feed end of the module. The valves to redirect concentrate to waste or back to the feedwater (see Figure 2-3) are closed. All raw water entering the insides of the fibers from the feed side of the module passes through the membrane pores as filtrate. The Hydranautics UF system also has the capability to waste concentrate and to recirculate concentrate to the suction side of the feed pump. The wasting or recirculation of concentrate limit the buildup of solids on the inside of the fibers during filtration, and are used in treating higher turbidity waters.

After extended periods of operation, typically on the order of weeks to months, the pressure required to force water through the membrane pores increases because some material is not effectively removed by backwash. This process is called membrane fouling. Once the system reaches a critical pressure, the system is shut down and a chemical cleaning is performed to restore membrane efficiency. The membrane is considered fouled when the transmembrane pressure increases to 15 to 20 psi (1.0 to 1.4 bar). Cleaning the Hydranautics unit is a two-step process. A citric acid solution with pH between 2.0 and 2.5 is used first. This is followed by a caustic cleaning step with pH of approximately 12. The caustic cleaning step is followed with a pH 2 hydrochloric acid rinse to remove any metals that may have precipitated during the high pH clean.

Each step in the cleaning process involves preparing approximately 30 gallons of cleaning solution, preheated to 35 °C, in the filtrate storage tank contained on the test unit skid. Hoses and valves are reconfigured so the feed pump draws cleaning solution from the filtrate storage tank. The membrane concentrate flow is redirected back to the filtrate storage tank. The feed pump is started, and the system is adjusted to operate at a feed pressure of 15 psi (1.0 bar), concentrate flow of 3 - 4 gpm (11 – 15 L/min), with no filtrate flow for 60 minutes. After this, the filtrate valve is adjusted to allow a filtrate flow of 4 gpm (15 L/min), with the same concentrate flow for 15 minutes. After the cleaning step is complete, the cleaning solution is directed to drain, the filtrate storage tank is filled with tap water and the unit is backwashed 3 times to remove residual cleaning solution from the membrane module. Again, if tap water was used to prepare the cleaning solutions, a pH 2 hydrochloric acid rinse is conducted after the caustic cleaning step to remove possible metal precipitates.

Filtration, in the Hydranautics test unit, is accomplished with a HYDRACap™ UF membrane module (see Table 2-1). The HYDRACap™ is a hollow fiber configuration with fibers potted at both ends. Each fiber has an inside diameter of approximately 0.031 inch (0.8 mm), an outside diameter of 0.051 inch (1.3 mm) and is 3.1 feet (0.94 m) long. With 10,000 fibers per module, the surface area of each module is approximately 270 square feet (25 square meters). The membrane material is polyether sulfone. The membrane surface has a neutral charge and is

hydrophilic. The membrane is chlorine tolerant and has an operating pH range of 2 – 13. The membrane can operate to a maximum transmembrane pressure of 20 psi (1.4 bar).

The fibers are contained in a fiberglass cylinder that has a central filtrate tube. This membrane module is contained inside a standard 8 inch (20 cm) diameter pressure vessel similar to those used to house reverse osmosis membranes. Fibers are grouped in discrete pie-shaped segments around the central filtrate tube.

## 2.2 Description of Physical Construction/Components of the Equipment

The Hydranautics UF unit was a skid-mounted with a footprint of approximately 8 feet 4 inches (2.5 m) long by 3 feet 10 inches (1.3 m) deep. The test unit is 7 feet 7 inches (1.2 m) in height. The base and frame of the test unit was constructed of steel. At a weight of 750 pounds (340 Kg), the unit can be moved with a forklift and transported by truck. The Hydranautics UF unit is self contained, requiring only connections to feedwater, drain and electrical. The electrical requirements of the system are 20 amps of 240 volt single-phase power.

The major components of the Hydranautics ETV test system included:

- Two 270 ft<sup>2</sup> (25 m<sup>2</sup>) horizontally mounted Hydranautics HYDRACap™ UF modules housed in 8 inch (20 cm) pressure vessels
- PLC-based control system
- Backwash pump
- Feed pump
- Filtrate storage / cleaning tank
- 300 micron pre-filter
- Air compressor
- Pneumatic valves
- Sodium hypochlorite tank and metering pump
- Rotameter flow meters
- Analog pressure gauges
- Analog feed thermometer.

Figure 2-2 presents the spatial requirements and layout of the major components of the ETV test unit.

## Chapter 3 Materials and Methods

### 3.1 Testing Site Name and Location

The test site selected for the ETV program is the City of San Diego's Aqua 2000 Research Center at 14103 Highland Valley Road in Escondido, California.

#### *3.1.1 Site Background Information*

The Aqua 2000 Research Center was established in 1995 to conduct most of the research work related to the Water Repurification Project of the City of San Diego. The Center has dedicated full time operators with substantial experience in operating membrane systems. This site is also connected to San Diego County Water Authority's Aqueduct System. Sufficient influent water supply, electrical power, and drainage lines to a wastewater treatment plant were provided to the ETV test system treatment train.

#### *3.1.2 Test Site Description*

Figure 3-1 is a schematic diagram of the test site and the location of the membrane test unit. Below is a list of the facilities and equipment that were available at the test site.

#### **Structural**

- 5,000 square foot concrete pad.
- Semi-permanent shading to protect from sunlight.
- Potable water connections.
- San Diego County Water Authority's Aqueduct System connections.
- Drainage system connected to a wastewater plant.
- Chemical containment area.
- Sufficient lighting for 24-hour operation.
- Full electrical supply.
- Chemical safety shower and eyewash.
- An operations trailer with conference room, offices, and computers.
- A laboratory trailer for on-site water quality analyses.

#### **Instrumentation/Equipment**

##### *On-Site Laboratory*

- DR 4000 Spectrophotometer by Hach
- Ratio/non-ratio 2100N Turbidimeter by Hach
- pH/Temperature meter by Accumet Research (AR-15)
- Portable conductivity meter by Fisher (No. 09-327-1)
- Two total organic carbon (TOC) analyzers (Sievers Model No. 800)

### ***Concrete Pad***

- Feed, filtrate, backwash, and waste storage tanks.
- Chemical Cleaning Skid with hot water supply.
- Chemical Feed Systems.
- Micro 2000 On-line Chlorine Analyzer
- Four 1720D On-line Hach Turbidimeters
- Four 1900WPC On-line Hach Particle Counters

### ***Raw Water Intake***

The raw water was delivered to the test site through schedule 80 PVC pipe. The San Diego Aqueduct connection was approximately 1 mile away from the test site. The available water flow rate was 150 gpm.

### ***Collection of Raw Water***

The raw water was directed to a covered tank with an overflow system. The feedwater pipe of the test unit was connected to the covered raw water tank.

### ***Handling of Treated Water and Residuals***

The Aqua 2000 research center has a drainage system that connects to a wastewater treatment plant. All of the filtrate, backwash water, and any chemicals used were directed to waste.

## **3.2 Source/Feed Water Quality**

The source of feedwater for the ETV testing is San Diego Aqueduct Water. The aqueduct is supplied primarily from Lake Skinner which receives Colorado River Water (CRW) from the West Portal of the San Jacinto Tunnel, and State Project Water (SPW) from Lake Silverwood. A typical blending ratio of these two waters in Lake Skinner is 70 percent CRW and 30 percent SPW. The lower total dissolved solids (TDS) SPW is added to maintain the TDS of Lake Skinner at approximately 500 mg/L or less (depending on availability of SPW). The aqueduct water is characterized by relatively high levels of total dissolved solids, hardness and alkalinity, with moderate levels of organic material and relatively low turbidity.

Figure 3-2 illustrates Lake Skinner water quality for the period of November 1997 through November 1998, which is typical for this source water. The stable quality of the water is apparent in all parameters illustrated in the figure. Hardness ranged from 200 through 298 mg/L as CaCO<sub>3</sub>, alkalinity ranged from 108 to 130 mg/L as CaCO<sub>3</sub> and calcium ranged from 47 to 75 mg/L as Ca (118 to 188 mg/L as CaCO<sub>3</sub>). The hardness levels are quite high, with relatively high alkalinity as well. TDS ranged from 429 to 610 mg/L, indicating the relatively high level of salinity in this source water. pH ranged from 8.26 to 8.45 during the year.

Figure 3-3 illustrates turbidity, temperature and TOC for Lake Skinner water. Turbidity was relatively low with a range of 1.10 to 3.50 NTU. Lake Skinner exhibits relatively warm temperatures throughout the year, typical of many water supplies in the southwestern and southeastern United States. The temperature range was 13 to 27°C. Annual low temperatures on



the order of 10°C are typical of this supply. The levels of organic material, as quantified by TOC, are moderate in this supply. The TOC range was 2.33 to 2.94 mg/L.

### **3.3 Environmental Technology Verification Testing Plan**

This section describes the tasks completed for the ETV. The test equipment was operated 24 hours a day, seven days a week, with operations staff on-site Monday through Friday for one 8-hour shift each day. Tasks that were performed by the operations and engineering staff are listed below:

- Task 1: Characterization of Membrane Flux and Recovery
- Task 2: Evaluation of Cleaning Efficiency
- Task 3: Evaluation of Finished Water Quality
- Task 4: Reporting of Membrane Pore Size
- Task 5: Membrane Integrity Testing
- Task 6: Data Management
- Task 7: Quality Assurance/Quality Control
- Task 8: Microbial Removal (optional)

An overview of each task is provided below.

#### **3.3.1 Task 1: Characterization of Membrane Flux and Recovery**

The objective of this task is to evaluate the membrane operational performance. Membrane productivity was evaluated relative to feedwater quality. The rates of transmembrane pressure increase and/or specific flux decline were used, in part, to evaluate operation of the membrane equipment under the operating conditions being verified and under the raw water quality conditions present during the verification testing period.

##### **Work Plan**

After set-up and shakedown of the membrane equipment, membrane operation was established at the flux condition being verified in this ETV. Testing took place over two 30-day test periods. When substantial specific flux decline occurred before the end of the 30-day test period, chemical cleaning was performed and (if necessary) adjustments to the operational strategy were made. Measurement of the membrane system flows, pressures and temperatures were collected at a minimum of twice a day.

#### **3.3.2 Task 2: Evaluation of Cleaning Efficiency**

An important aspect of membrane operation is the restoration of membrane productivity after specific flux decline has occurred. The objective of this task is to evaluate the effectiveness of chemical cleaning for restoring finished water productivity to the membrane system. The recovery of specific flux and the fraction of original specific flux lost were determined after each chemical cleaning.

## Work Plan

The membrane was operated at the flux condition being verified in this ETV until such time as the termination criteria were reached. The two criteria for cleaning of the membrane were: 1) reaching the minimum specific flux operational limit of the membrane (specific flux < 4.6 gfd/psi), or, 2) completing the 30-day test period. The membrane was chemically cleaned when either of these termination criteria was reached. Chemical cleaning was performed in accordance to the manufacturer procedure (see Appendix A). For the feedwater utilized in this ETV, the manufacturer recommended their typical chemical cleaning procedure using citric acid and caustic cleaning solutions.

The first cleaning step uses a 2 percent citric acid solution in tap water preheated to 35 °C, with pH in the range 2.0 to 2.5. This is followed by a high pH cleaning step using 0.5 percent caustic solution in tap water preheated to 35 °C, with pH in the range 11.5 to 12.5. The caustic cleaning step includes a final pH 2 hydrochloric acid rinse to remove potential metal precipitates.

To determine cleaning efficiency, flux-pressure profiles were developed at each stage of the chemical cleaning procedure (i.e., before cleaning, after first chemical solution, after second chemical solution). The slope of the flux-pressure profile represents the specific flux of the membrane at each cleaning stage and was used to calculate the cleaning efficiency indicators. Two primary indicators of cleaning efficiency and restoration of membrane productivity were examined in this ETV:

1. The immediate recovery of membrane productivity, as expressed by the ratio between the final specific flux value of the current filtration run ( $J_{sf}$ ) and the initial specific flux ( $J_{si}$ ) measured for the subsequent filtration run:

$$\text{Recovery of Specific Flux} = 100 \times [1 - (J_{sf} \div J_{si})]$$

where:  $J_{sf}$  = specific flux (gfd/psi, L/(h-m<sup>2</sup>)/bar) at end of current run (final)  
 $J_{si}$  = specific flux (gfd/psi, L/(h-m<sup>2</sup>)/bar) at beginning of subsequent run (initial)

2. The loss of specific flux capabilities is expressed by the ratio between the initial specific flux for any given filtration run ( $J_{si}$ ) and the specific flux ( $J_{sio}$ ) at time zero, as measured at the initiation of the first filtration run in a series:

$$\text{Loss of Original Specific Flux} = 100 \times [1 - (J_{sf} \div J_{sio})]$$

where:  $J_{sio}$  = specific flux (gfd/psi, L/(h-m<sup>2</sup>)/bar) at time t = 0 of membrane testing

### **3.3.3 Task 3: Evaluation of Finished Water Quality**

The objective of this task is to evaluate the quality of water produced by the ETV test system. Many of the water quality parameters described in this task were measured on-site. Analyses of the remaining water quality parameters were performed by the City of San Diego Laboratory, a State-certified analytical laboratory.

#### **Work Plan**

The parameters monitored during this ETV and the methods used for their measurement are listed in Table 3-1. Finished water quality was evaluated relative to feedwater quality and operational conditions.

### **3.3.4 Task 4: Reporting of Membrane Pore Size**

Membranes for particle and microbial removal do not have a single pore size, but rather have a distribution of pore sizes. Membrane rejection capabilities are limited by the maximum membrane pore size.

#### **Work Plan**

The manufacturer was asked to supply the 90 percent and the maximum pore size of the membranes being tested in the ETV. The manufacturer was also asked to identify the general method used in determining the pore size values.

### **3.3.5 Task 5: Membrane Integrity Testing**

A critical aspect of any membrane process is the ability to verify that the process is producing a specified water quality on a continual basis. For example, it is important to know whether the membrane is providing a constant barrier to microbial contaminants. The objective of this task is to evaluate one or more integrity monitoring methods for the membrane system.

#### **Work Plan**

The selected methods for monitoring of membrane integrity of the Manufacturer's UF system during this study are described below:

#### **Air Pressure-Hold Test**

The air pressure-hold test is one of the direct methods for evaluation of membrane integrity. This test can be conducted on several membrane modules simultaneously; thus, it can test the integrity of a full rack of membrane modules used for full-scale systems. The test is conducted by pressurizing the filtrate side of the membrane after which the pressure is held and the decay rate is monitored over time. Minimal loss of the held pressure (generally less than 1 psi every 5 minutes) at the filtrate side indicates a passed test, while a significant decrease of the held pressure indicates a failed test.

### **Particle Counting**

On-line particle counting in the size ranges of 2-3 um, 3- 5 um, 5-15 um, >15 um was used in this ETV as an indirect method of monitoring membrane integrity.

### **Turbidity Monitoring**

On-line turbidity monitoring was also used in this ETV as an indirect method of monitoring membrane integrity.

#### **3.3.6 Task 6: Data Management**

The objective of this task is to establish the protocol for management of all data produced in the ETV and for data transmission between the FTO and the NSF.

#### **Work Plan**

According to EPA/NSF ETV protocols, a data acquisition system was used for automatic entry of on-line testing data into computer databases. Specific parcels of the computer databases for on-line particle and turbidity were then downloaded for importation into Excel as a comma delimited file. These specific database parcels were identified based on discrete time spans and monitoring parameters. In spreadsheet form, data were manipulated into a convenient framework to allow analysis of membrane equipment operation. For those parameters not recorded by the data acquisition system, field-testing operators recorded data and calculations by hand in laboratory notebooks. Daily measurements were recorded on specially-prepared data log sheets as appropriate.

The database for the project was set up in the form of custom-designed spreadsheets. The spreadsheets were capable of storing and manipulating each monitored water quality and operational parameter from each task, each sampling location, and each sampling time. Data from the log sheets were entered into the appropriate spreadsheet. Following data entry, the spreadsheet was printed out and the printout was checked against the handwritten data sheet. Any corrections were noted on the hard-copies and corrected on the screen, and then a corrected version of the spreadsheet was printed out. Each step of the verification process was initiated by the field testing operator or engineer performing the entry or verification step.

Data from the outside laboratory were received and reviewed by the field testing operator. Data from the onsite lab and City of San Diego Microbiology lab were entered into the data spreadsheets, corrected, and verified in the same manner as the field data. Data from the City of San Diego Water Quality lab were received both electronically and in hardcopy printouts generated from the electronic data.

#### **3.3.7 Task 7: Quality Assurance/Quality Control**

An important aspect of verification testing is the protocol developed for quality assurance (QA) and quality control (QC). The objective of this task is to assure the high quality of all measurements of operational and water quality parameters during the ETV.

## **Work Plan**

Equipment flow rates and pressures were documented and recorded on a routine basis. A routine daily walk-through during testing was performed each morning to verify that each piece of equipment or instrumentation is operating properly. On-line monitoring equipment, such as flow meters, are checked to confirm that the read-out matches the actual measurement and that the signal being recorded is correct. Below is a list of the verifications conducted:

## **Monitoring Equipment**

### ***System Pressure Gauges***

Pressure and vacuum gauges supplied with the membrane systems tested were verified against grade 3A certified pressure or vacuum gauges purchased at the start of NSF testing. The certified pressure and vacuum gauges were manufactured by Ashcroft and have an accuracy of 0.25% over their range (0-30 psi pressure, 0-30 in Hg vacuum). Where possible, system gauges were removed and tested over the expected range of operating pressures against the verification gauge, using a portable hand pump. The Hydranautics system feed, concentrate and backwash pressure gauges were consistently accurate to within 5 percent or less over their range. The filtrate pressure gauge was accurate to within 0.4 psi.

### ***System Flow Rates***

Membrane system flow rates were verified volumetrically on a monthly basis near the beginning and end of each test period. System flows were diverted to a 55 gallon graduated tank for approximately 2 minutes. The measured flow rate was compared with flows indicated on rotameters. Measured and indicated flows agreed to within 3 percent for the filtrate rotameter.

## **Analytical Methods**

### ***pH***

An Accumet Research Model AR15 laboratory pH meter was used to conduct routine pH readings at the test facility. Daily calibration of the pH meter using pH 4, 7 and 10 buffers was performed. The slope obtained after calibration was recorded. The temperature of the sample when reading sample pH was also recorded.

### ***Temperature***

Accuracy of the feed water inline thermometer was verified against a National Institute of Standards and Technology (NIST) certified thermometer on 4/14/99, 6/16/99, 12/12/99 and 4/7/00. Comparisons were made at three temperatures covering the range of anticipated raw water temperatures. In all cases, the raw water thermometer compared to within 0.2 °C of the NIST certified thermometer.

### ***Turbidity***

On-line turbidimeters were used for measurement of turbidity in the raw and filtrate waters, and a bench-top turbidimeter was used for measurement of the feedwater and backwash waste water.

On-line Turbidimeters: Hach 1720D on-line turbidimeters were used during testing to acquire raw and filtrate turbidities at 1-minute intervals. The following procedures were followed to ensure the integrity and accuracy of these data:

- A primary calibration of the on-line turbidimeters was performed near the beginning of the test periods.
- Aquaview + data acquisition software was used to acquire and store turbidity data. Data were stored to the computer database each minute. After initial primary calibration of the turbidimeters, zero, mid-level and full-strength signals (4, 12 and 20 mA) were output from each turbidimeter to the data acquisition software. The signals received by the data acquisition software from all 4 on-line turbidimeters had less than one percent error over their range of output (0, 1 and 2 NTU for filtrate, and 0, 10 and 20 NTU for feed) as stored in the Aquaview database.
- The manufacturer's specified acceptable flow range for these turbidimeters is 250 to 750 mL/min. The flow range initially targeted during testing was 500 mL/min +/- 100 mL/min. On-line turbidimeter flows were verified manually with a graduated cylinder and stopwatch daily.
- Turbidimeter bodies were drained and sensor optics cleaned approximately every week on an as needed basis.
- On-line turbidities were compared to desktop turbidities when turbidity samples were collected. Comparative calibrations of the raw water on-line turbidimeter against the Hach 2100N desktop turbidimeter were conducted on an as needed basis during the course of the testing when the difference between on-line and desktop turbidity readings were greater than 10 percent.
- Approximately 50 ppm free chlorine solution was pumped through turbidity sample lines as needed to clean potential buildup from these lines.

Bench-top Turbidimeters: A Hach 2100N desktop turbidimeter was used to perform onsite turbidity analyses of raw water, backwash and filtrate samples. Readings were recorded in non-ratio operating mode. The following quality assurance and quality control procedures were followed to ensure the integrity and accuracy of onsite laboratory turbidity data:

Primary calibration of turbidimeter according to manufacturer's specification was conducted on a weekly basis. Secondary standard calibration verification was performed on a daily basis. Three secondary standards (approx. 0.8 NTU, 1.8 NTU and 20 NTU) were recorded after primary calibration and on a daily basis for the remaining 6 days until the next primary calibration. Proficiency samples with a known turbidity of 0.8 NTU were purchased from a commercial supplier. Turbidity proficiency samples were prepared and analyzed every two weeks.

### ***Particle Counting***

Hach 1900 WPC light blocking particle counters were used to monitor particles in raw and filtrate waters. These counters enumerate particles in the range 2 to 800 microns (um).



The particle counters were factory calibrated. Factory calibrations took place on May 25, 1999. The manufacturer recommends factory calibration on a yearly basis. The following procedures were followed to ensure the integrity and accuracy of the on-line particle data collected:

- The Aquaview software was configured to store particle counts in the following size ranges: 2-3 um, 3-5um, 5-15um and >15um.
- To demonstrate the comparative response of the particle counters, NIST traceable monospheres were purchased from Duke Scientific in the following sizes: 2um, 4um, 10um and 20um. Duke monospheres were added to constantly stirred DI water and pumped to one of the constant head flow controllers using a peristaltic pump. The flow from this controller was then directed to each of the particle counters for approximately 10 minutes. The same solution was used for each particle counter (raw water and filtrate).

The precise concentration of each monosphere was not known, but based on Duke Scientific estimates the following approximate concentration of each monosphere was present in the test solution:

- |        |                   |
|--------|-------------------|
| • 2um  | 1,000 - 10,000/mL |
| • 4um  | 100 - 1,000/mL    |
| • 10um | 10 - 100/mL       |
| • 20um | 1 - 10/mL         |

A typical response of the particle counters to the same monosphere solution near both test periods is presented in Figure 3-4. The particle counter response of the raw and filtrate particle counters to the same monosphere solution were within 35 percent in all size ranges that were monitored. The figures show a good comparative response of the raw water and filtrate particle counters to the same monosphere solution.

Flows through the particle counters were maintained at 200+/- 10 mL/min with constant head devices. Flows were verified on a daily basis with a graduated cylinder and stop watch. Flows were observed to be extremely consistent (typically within 2 mL/min of the target flow rate). Fifty mg/L free chlorine was run through particle counters for on an as needed basis to remove potential buildup.

### **Chemical and Microbial Water Quality Parameters**

The analytical work for the study was performed by the City of San Diego Laboratory, which is a State of California certified water laboratory. All water samples were collected in appropriate containers (containing preservatives as applicable) prepared by the City of San Diego laboratory. Samples for analysis of Total Coliforms (TC) and Heterotrophic Plate Count (HPC) analysis were collected in bottles supplied by the City of San Diego laboratory and transported with an internal cooler temperature of approximately 2 to 8°C to the analytical laboratory. All samples were preserved, stored, shipped and analyzed in accordance with appropriate procedures and holding times. All reported results had acceptable QA and met method-specific QC guidelines, which was confirmed by letters from the City of San Diego Water Quality and Marine Microbiology Laboratories (Appendix A). For the Marine Microbiology Laboratory, these QC procedures included the use of positive / negative controls, blanks and sterility checks.

### 3.3.8 Task 8: *Microbial Removal (Optional)*

The objective of this task is to evaluate microbial removal capabilities by seeding the membrane system with a selected virus. Removal capabilities were evaluated under the worst case scenario for the membrane system operation (in this case, directly after chemical cleaning of the membrane module).

#### **Work Plan**

The seeding experiments were performed at the test site and the samples collected during the seeding experiments were submitted to the City of San Diego Marine Microbiology Lab, a State-certified laboratory, for analysis of the seeded microorganisms.

#### **Organisms for Seeding Experiments**

The organism selected for seeding experiments is MS2 bacterial virus. MS2 virus is not a human pathogen; however, this organism is similar in size (0.025 microns), shape (icosahedron) and nucleic acid (RNA) to polio and hepatitis virus. Since MS2 is not a human pathogen, live MS2 virus was used in the seeding experiments. Organism stocks received from the suppliers were stored refrigerated at 4°C in the dark until use in the seeding experiments.

#### **Microbial Seeding Protocols**

MS2 virus was added continuously to the membrane feed starting at the completion of a backwash. The membrane system was operated for one service cycle to stabilize the organism concentration in the membrane system, after which sampling was initiated. The microorganism concentration in the feed water was sufficient to demonstrate a minimum of 4 logs of removal of the seeded organism.

During the MS2 seeding experiment, three samples from the membrane feed water and three samples from the filtrate water were collected during the second and third service cycles after the initiation of seeding. The first filtrate sample during each filtration cycle was collected within the first minute of filtration after completion of backwash. The last filtrate sample during each filtration cycle was collected within 3 minutes of the end of the cycle. Each sample was collected in sterile 250-mL bottles, was stored at 1°C and processed within 24 hours.

The MS2 seeding experiments were conducted at the beginning of Test Periods 1 and 2. The experiments were conducted under the operating conditions in which the microorganisms would most likely penetrate the membrane; when the membrane is clean, and at a high flux rate (Jacangelo et al. 1995, Montgomery Watson, 1997 and 1999). Therefore, the membrane was cleaned immediately prior to MS2 seeding.

### 3.4 Calculation of Membrane Operating Parameters

#### 3.4.1 Filtrate Flux

The average filtrate flux is the flow of product water divided by the surface area of the membrane. Flux is expressed only as gfd and L/(hr-m<sup>2</sup>) in accordance with EPA/NSF ETV protocol. Filtrate flux is calculated according to the following formula:

$$J_t = Q_p \div S$$

where  $J_t$  = filtrate flux at time t (gfd, L/(hr-m<sup>2</sup>))  
 $Q_p$  = filtrate flow (gpd, L/hr)  
 $S$  = membrane surface area (ft<sup>2</sup>, m<sup>2</sup>)

#### 3.4.2 Specific Flux

The term specific flux is used to refer to filtrate flux that has been normalized for the transmembrane pressure. The equation used for calculation of specific flux is:

$$J_{tm} = J_t \div P_{tm}$$

where  $J_{tm}$  = specific flux at time t (gfd/psi, L/(hr-m<sup>2</sup>)/bar)  
 $J_t$  = filtrate flux at time t (gfd, L/(hr-m<sup>2</sup>))  
 $P_{tm}$  = transmembrane pressure (psi, bar)

#### 3.4.3 Transmembrane Pressure

The average transmembrane pressure is calculated as follows:

$$P_{tm} = [(P_i + P_o) \div 2] - P_p$$

where  $P_{tm}$  = transmembrane pressure (psi, bar)  
 $P_i$  = pressure at the inlet of the membrane module (psi, bar)  
 $P_o$  = pressure at the outlet of the membrane module (psi, bar)  
 $P_p$  = filtrate pressure (psi, bar)

#### 3.4.4 Temperature Adjustment for Flux Calculation

Temperature corrections to 20°C for transmembrane flux were made to account for the variation of water viscosity with temperature. The following equation was employed:

$$J_{tm} \text{ (at 20°C)} = [Q_p \times e^{(-0.0239 \times (T - 20))}] \div S$$

where  $J_{tm}$  = instantaneous flux (gfd, L/(hr-m<sup>2</sup>))  
 $Q_p$  = filtrate flow (gpd, L/hr)  
 $T$  = temperature, (°F, °C)  
 $S$  = membrane surface area (ft<sup>2</sup>, m<sup>2</sup>)

### 3.4.5 Feedwater System Recovery

The recovery of filtrate from feedwater is the ratio of filtrate flow to feedwater flow:

$$\% \text{ System Recovery} = 100 \times (Q_p/Q_f)$$

where  $Q_p$  = filtrate flow (gpd, L/hr)  
 $Q_f$  = feed flow to the membrane (gpd, L/hr)

### 3.4.6 Rejection

The rejection of contaminants by membrane process was calculated as follows:

$$R = \left(1 - \frac{C_p}{C_f}\right) * 100\%$$

where:  $R$  = Rejection, %  
 $C_p$  = Filtrate water concentration, (mg/L)  
 $C_f$  = Feed water concentration, (mg/L)

## 3.5 Calculation of Data Quality Indicators

### 3.5.1 Precision

As specified in Standard Methods (Method 1030 C), precision is specified by the standard deviation of the results of replicate analyses. An example of replicate analyses in this ETV is the biweekly analysis of turbidity proficiency samples. The overall precision of a study includes the random errors involved in sampling as well as the errors in sample preparation and analysis.

$$\text{Precision} = \text{Standard Deviation} = \sqrt{\left[\frac{\sum_{i=1}^n (\bar{X}_i - \bar{X})^2}{n - 1}\right]}$$

where:  $\bar{X}$  = sample mean  
 $\bar{X}_i$  =  $i$ th data point in the data set  
 $n$  = number of data points in the data set

### 3.5.2 Relative Percent Deviation

For this ETV, duplicate samples were analyzed to determine the overall precision of an analysis using relative percent deviation. An example of duplicate sampling in this ETV is the daily duplicate analysis of turbidity samples using the bench-top turbidimeter.

$$\text{Relative Percent Deviation} = 100 \times \left[\frac{(x_1 - x_2)}{\bar{X}}\right]$$

where  $\bar{X}$  = sample mean  
 $x_1$  = first data point of the set of two duplicate data points  
 $x_2$  = second data point of the set of two duplicate data points

### 3.5.3 Accuracy

Accuracy is quantified as the percent recovery of a parameter in a sample to which a known quantity of that parameter was added. An example of an accuracy determination in this ETV is the analysis of a turbidity proficiency sample and comparison of the measured turbidity to the known level of turbidity in the sample.

$$\text{Accuracy} = \text{Percent Recovery} = 100 \times [X_{\text{measured}} \div X_{\text{known}}]$$

where  $X_{\text{known}}$  = known concentration of measured parameter  
 $X_{\text{measured}}$  = measured concentration of parameter

### 3.5.4 Statistical Uncertainty

For the water quality parameters monitored, 95 percent confidence intervals were calculated. The following equation was used for confidence interval calculation:

$$\text{Confidence Interval} = \bar{X} \pm [t_{n-1, 1 - (\alpha/2)} \times (S/\sqrt{n})]$$

where:  $\bar{X}$  = sample mean  
 $S$  = sample standard deviation  
 $n$  = number of independent measurements included in the data set  
 $t$  = Student's t distribution value with n-1 degrees of freedom  
 $\alpha$  = significance level, defined for 95 percent confidence as:  $1 - 0.95 = 0.05$

According to the 95 percent confidence interval approach, the  $\alpha$  term is defined to have the value of 0.05, thus simplifying the equation for the 95 percent confidence interval in the following manner:

$$95 \text{ Percent Confidence Interval} = \bar{X} \pm [t_{n-1, 0.975} \times (S/\sqrt{n})]$$

## 3.6 Testing Schedule

The ETV schedule is illustrated in Figure 3-5. The testing program took place starting in August 1999, and finishing by the end of March 2000. Test Period 1 represented the summer/autumn seasons and Test Period 2 represented the winter/spring seasons.

## Chapter 4

### Results and Discussion

This chapter presents the data obtained under each task of the ETV program of the Hydranautics UF system.

#### 4.1 Task 1: Characterization of Membrane Flux and Recovery

The operating conditions for the Hydranautics UF membrane system are provided in Table 4-1. The manufacturer established these operating parameters for the ETV testing. The membrane system ran at a target flux of 69 gfd (115 L/hr-m<sup>2</sup>). Filtration cycle length was 19 minutes followed by a 65 second backwash. Filtrate consumed during backwash was 30 gallons (114 liters) for Test Period 1 and 25 gallons (95 liters) for Test Period 2. Feed water consumed during backwash was 7 gallons (26 liters). The backwash water was chlorinated at 10 – 15 mg/L during the first run in Test Period 1. This was increased for the remainder of testing to 15 – 20 mg/L. The feed water recovery during Test Period 1 of 85 percent, increased to 87 percent during Test Period 2 when the backwash volume was decreased by 5 gallons (19 liters).

Figure 4-1 (A and B) provides the membrane transmembrane pressure and temperature profiles for Test Periods 1 and 2. For Test Period 1, the clean membrane transmembrane pressure began at approximately 3 - 4 psi. The transmembrane pressure stabilized at 6 – 9 psi for 7 days and then the test unit fouled rapidly over a period of 2 days. The cause of the rapid fouling at the end of the first run was believed to be algae. This was evidenced by the daily buildup of algae observed in the prescreen to the raw water particle counter and from verbal verification of an algae bloom at Lake Skinner by the Aqueduct operations staff. Algae counts were not quantified. After cleaning, the transmembrane pressure returned to 3 - 4 psi. This increased to 10 – 12 psi over one day, but then decreased to approximately 6 psi for the remainder of Test Period 1 as the algae bloom subsided and the system recovered. Transmembrane pressure at the beginning of Test Period 2 was 5 psi. This increased over 3 days to 11 psi before an interruption in the raw water supply forced a shutdown of the system for few days. After restarting the system, the transmembrane pressure generally decreased over the remainder of Test Period 2 from a high of 13-14 psi to approximately 8 psi which is likely due to fixing the backwash chlorine feed system and increasing the backwash volume which is discussed below.

Figure 4-2 (A and B) provides the membrane flux and specific flux profiles for Test Periods 1 and 2. The target flux during Test Periods 1 and 2 was 69 gfd (117 L/hr-m<sup>2</sup>). For Test Period 1 (summer/autumn), the average temperature adjusted membrane flux was 50 - 60 gfd at 20°C. Due to the relatively lower water temperatures during Test Period 2 (winter/spring), a higher average temperature adjusted membrane flux of 70 - 80 gfd at 20°C was observed. The temperature adjusted specific flux decreased from 19 gfd/psi at 20°C to 3 gfd/psi at 20°C over 9 days at the start of Test Period 1. Chemical cleaning recovered specific flux to approximately 12 gfd/psi at 20°C. After initial rapid fouling, the specific flux gradually recovered, as the algae bloom subsided, for most of the remainder of Test Period 1. Temperature adjusted specific flux decreased from 15 gfd/psi at 20°C to 7 gfd/psi at 20°C over the first 3 days of operation in Test Period 2. After a shutdown in the raw water supply, the specific flux decreased for a period of five days until February 28, 2000. At this point, repairs were made to the backwash chlorine



feed system, which was prone to air binding, and adjustments were made to the backwash flow rate. These adjustments improved the consistency of chlorine in the backwash water, and slightly increased backwash pressure and volume. After this, the system recovered specific flux to approximately 10 gfd/psi at 20°C by the end of Test Period 2.

The same data in Figures 4-1 and 4-2 are also provided in Appendix A of this report, but with metric units.

#### **4.2 Task 2: Evaluation of Cleaning Efficiency**

Chemical cleanings were performed when the membrane fouled (transmembrane pressure in the range 15 to 20 psi [1.0 to 1.4 bar]), or when the end of a test period was reached. The manufacturer's cleaning procedure was a two step process. A citric acid cleaning solution was used first, followed by a caustic cleaning solution. The 2 percent citric acid cleaning solution was prepared by dissolving 4 pounds (1.8 kg) of citric acid in approximately 30 gallons of tap water preheated to 35 °C. The pH of this solution was in the range 2 to 2.5. The citric acid solution was placed in the filtrate tank and recirculated through the feed side of the membrane for 60 minutes at a flow of 3 to 4 gpm (11 to 15 L/min) with a feed pressure of approximately 15 psi. After this, filtrate flow was adjusted to 4 gpm (15 L/min) and the cleaning solution was allowed to recirculate for an additional 15 minutes. After discarding the cleaning solution and triple rinsing the system with tap water, the same cleaning procedure was followed using a high pH cleaning solution. The high pH cleaning solution was made by adding 1 liter caustic (40 percent Sodium Hydroxide) to 30 gallons tap water preheated to 35 °C. The pH of this solution was in the range of 11.5 to 12.5. Since the high pH cleaning solution was prepared in tap water, the caustic cleaning step was followed by a pH 2 hydrochloric acid rinse to remove any precipitates that potentially formed under these conditions.

The flux-pressure profiles of the membrane system at different stages of the chemical cleaning procedure for Test Periods 1 and 2 are shown in Figures 4-3 and 4-4, respectively. The slope of the flux-pressure profile represents the specific flux of the membrane at each cleaning stage and was used to calculate the cleaning efficiency indicators. These are listed in Table 4-2. The recovery of specific flux for the two cleanings in Test Period 1 were 74 percent and 31 percent. The lower recovery in after the second cleaning was due to the fact the membrane was not completely fouled when the cleaning was conducted. The recovery of specific flux for the cleaning at the end of Test Period 2 was 45 percent. Again, this was limited due to the fact the membrane was not completely fouled.

New membranes are generally expected to have a noticeable loss of the original specific flux values after the first operation cycle. After that, a much lower irreversible fouling rate is usually observed (if any) as the membrane gets conditioned to the water chemistry. This was evident in the data presented in Table 4-2, where the maximum loss of original specific flux was observed after the first chemical cleaning. No additional loss of original specific flux was experienced after the second cleaning. All of the original specific flux lost in Test Period 1 was recovered in the final cleaning at the end of Test Period 2. This is possibly due to the fact that the membrane was not significantly fouled when this cleaning was conducted. Since no consistent trend was observed for the loss of the original specific flux data, the usable membrane life can not be estimated.



The same data in Figures 4-3 and 4-4 are also provided in Appendix A of this report, but with metric units. In addition, the manufacturer's detailed cleaning procedure is included in Appendix A.

### 4.3 Task 3: Evaluation of Finished Water Quality

Several water quality parameters were monitored during testing. Below is a summary of the water quality data.

#### 4.3.1 Turbidity, Particle Concentration and Particle Removal

Figures 4-5 and 4-6 present the on-line turbidity profile for the Hydranautics UF membrane system during Testing Periods 1 and 2, respectively. The figures show on-line turbidity for raw and filtrate water and desktop turbidity for raw water, filtrate and backwash waste. The desktop turbidity data are summarized in Table 4-3 and the on-line turbidity data are summarized in Table 4-4. For both testing periods, the raw water turbidity was in the range of 1-3 NTU. The turbidity of the backwash waste water averaged about 14 NTU for Test Period 1 and 8.0 NTU for Test Period 2. The filtrate turbidity was typically below 0.1 NTU.

Figures 4-7 and 4-8 present the particle count profile (2-3  $\mu\text{m}$ , 3-5  $\mu\text{m}$ , and 5-15  $\mu\text{m}$ , >15  $\mu\text{m}$ ) collected during Test Periods 1 and 2, respectively. The data presented represent 4-hour average values of data collected at one minute intervals. For both testing periods, the feed particle concentration of the *Cryptosporidium*-sized particles (3-5  $\mu\text{m}$ ) and *Giardia*-sized particles (5-15  $\mu\text{m}$ ) were in the range of 700 to 10,000 particle/mL, while the filtrate concentration was typically in the range of 1 to 10 particle/mL during Test Period 1. These data show high particle counts after each chemical cleaning which gradually dropped with time of operation. Since significant virus rejection was achieved after chemical cleaning (see Section 4.8), it is not believed that the higher particle count is due to penetration of particles through the membrane but rather due to release of particles and/or air bubbles from the filtrate side piping of the system. The membrane was not compromised throughout the testing period (see Section 4.5). Filtrate particle levels during Test Period 2 were in the range 0.1 to 1 particle/mL (except after chemical cleaning). The gap in the data during Test Period 2 was due to an interruption in the raw water supply.

Figures 4-9 and 4-10 present the log removal of particles (2-3  $\mu\text{m}$ , 3-5  $\mu\text{m}$ , and 5-15  $\mu\text{m}$ , >15  $\mu\text{m}$ ) based on raw and filtrate particle count data collected during Test Periods 1 and 2, respectively. Data presented on this plot represent 1-day average values of data collected at one minute intervals. The on-line turbidity and particle removal data are also summarized in Table 4-4. Removal ranged from 1.4 to 3.4 logs for the *Cryptosporidium*-sized particles (3-5  $\mu\text{m}$ ) and *Giardia*-sized particles (5-15  $\mu\text{m}$ ) during Test Period 1. Removals improved to between 2.3 and 4.0 logs for the *Cryptosporidium*-sized particles and *Giardia*-sized particles during Test Period 2. Figure 4-10 shows lower particle removals were observed on February 29, 2000. The lower particle removals are most likely related to two corrective actions to the test unit that occurred that day. The backwash volume was increased and two o-rings in the sodium hypochlorite backwash feed tubing were replaced. The sodium hypochlorite feed pump had been losing prime intermittently because of the previous o-rings leaked. The combination of the increased backwash flow and renewed chlorine backwash feed concentration caused a temporary increase

in removal of solids from the filtrate side of the membrane and filtrate piping. The filtrate particle concentrations returned to normal levels within one day as the system reached equilibrium in the new backwash environment.

To assist in assessing test system performance, Figure 4-11 presents the probability plots of the membrane system filtrate turbidity and particle removal data for the *Cryptosporidium*-sized particles (3-5  $\mu\text{m}$ ) and *Giardia*-sized particles (5-15  $\mu\text{m}$ ). The figure shows that the filtrate turbidity was 0.05 NTU or below 95 percent of times, that removal of 3-5  $\mu\text{m}$  particles was greater than 2.5 logs 95 percent of times and that removal of 5-15  $\mu\text{m}$  particles was greater than 2.2 logs 95 percent of times.

#### **4.3.2 *Indigenous Bacteria Removal***

The removal of naturally occurring bacteria was also monitored during the ETV study (see Table 4-5). The influent total coliform bacteria ranged from <2 to 23 MPN/100mL during Test Period 1 and from <2 to 17 MPN/100mL during Test Period 2. Total coliform bacteria were not detected (<2 MPN/100mL) in the filtrate of the Hydranautics UF membrane system during either test period. HPC bacteria were also reduced significantly by membrane filtration, however, up to 4 cfu/mL were enumerated in the filtrate during the warmer weather of Test Period 1. Previous studies (Jacangelo et al., 1995) have demonstrated that HPC bacteria can be introduced on the filtrate side of the membrane rather than by penetration through it.

#### **4.3.3 *Other Water Quality Parameters***

Table 4-6 presents the results of general water quality parameters across the Hydranautics UF system for Test Periods 1 and 2. As expected, no change was observed in the alkalinity, total dissolved solids, total hardness, and calcium hardness of the water across the membrane system. The membrane process resulted in minor reductions in organic material in the filtrate.

The total suspended solids (TSS) in the backwash waste reached as high as 36 mg/L (during Test Period 1), while the filtrate TSS remained consistently below the detection limit (1 mg/L).

Table 4-7 presents the mass balance conducted on total suspended solids across the membrane system. One of the eight calculated results showed a relatively good correlation between calculated and measured waste stream TSS. The relatively poor predictions of actual backwash TSS may in part be due to the TSS in the raw water being near the detection limit of the analysis, 1 mg/L.

#### **4.4 Task 4: Reporting Membrane Pore Size**

A request was submitted to the membrane Manufacturer to provide the 90 percent and maximum pore size of the membrane being verified. In their response, Hydranautics included a chart of percent rejection versus molecular weight. From this chart it appears the 90 percent pore size is approximately 180,000 daltons and the absolute pore size is approximately 600,000 daltons.

The determination was made using polyethylene glycol as a marker, according to a procedure described by G. Shock in *Journal Membrane Science* (1989).

The above information are taken from a letter supplied by the manufacturer which is included in Appendix A of this report. This is provided for informational purposes only and the results were not verified during the ETV testing.

#### **4.5 Task 5: Membrane Integrity Testing**

Figure 4-12 shows the results of the air pressure-hold tests conducted on the UF membrane at the beginning and end of both testing periods. The air pressure-hold test on the Hydranautics system was conducted by pressurizing the feed side of the membrane rather than the standard procedure of pressurizing the filtrate side. If any of the membrane fibers were compromised, one would expect significant loss of held pressure ( $> 1$  psi every 5 minutes) across the membrane element. Since no significant change in the held pressure ( $< 0.5$  psi every 5 minutes) was observed during both testing periods, it would be reasonable to assume that the membrane modules were uncompromised during both testing periods. The above is also confirmed with the turbidity profiles shown in Figures 4-5 and 4-6 and the particle count profiles shown in Figures 4-7 and 4-8. The particle concentrations in the filtrate would be expected to noticeably increase if the membrane module were compromised (Adham et. al., 1995, Montgomery Watson, 2000).

#### **4.6 Task 6: Data Management**

##### ***4.6.1 Data Recording***

Data were recorded manually on operational and water quality data sheets prepared specifically for the study. In addition, other data and observations such as the system calibration results were recorded manually on laboratory and QC notebooks. Data from the particle counters and turbidimeters were also recorded via data acquisition systems. All of the raw data sheets are included in Appendix B of this report.

##### ***4.6.2 Data Entry, Validation, and Reduction***

Data were first entered from raw data sheets into similarly designed data entry forms in a spreadsheet. Following data entry, the spreadsheet was printed and checked against handwritten datasheets. All corrections were noted on the electronic hard copies and then corrected on the screen. The hardcopy of the electronic data are included in Appendix C of this report.

#### **4.7 Task 7: Quality Assurance/Quality Control (QA/QC)**

The objective of this task is to assure the high quality and integrity of all measurements of operational and water quality parameters during the ETV program. Below is a summary of the analyses conducted to ensure the correctness of the data.

##### ***4.7.1 Data Correctness***

Data correctness refers to data quality, for which there are five indicators:

- Representativeness

- Statistical Uncertainty
- Completeness
- Accuracy
- Precision

Calculation of the above data quality indicators were outlined in the Materials and Methods section. All water quality samples were collected according to the sampling procedures specified by the NSF protocols, which ensured the representativeness of the samples. Below is a summary of the calculated indicators.

#### ***4.7.2 Statistical Uncertainty***

Ninety-five percent confidence intervals were calculated for the water quality parameters of the Hydranautics UF system. These include turbidity, particle concentrations, particle removal, and indigenous bacteria. Ninety-five percent confidence intervals were presented in summary tables in the discussion of Task 3 – Finished Water Quality.

#### ***4.7.3 Completeness***

Data completeness refers to the amount of data collected during the ETV study as compared to the amount of data that were proposed in the FOD. Calculation of data completeness was made for onsite water quality measurements, laboratory water quality measurements, and operational data recording. These calculations are presented in Appendix A of this report. Nearly all parameters were 100 percent complete. Overall, the database of laboratory water quality data and operational readings was more than 85 percent complete, which met the objective of the ETV program.

#### ***4.7.4 Accuracy***

Accuracy is quantified as the percent recovery of a parameter in a sample to which a known quantity of that parameter was added. An example of an accuracy determination in this ETV is the analysis of a turbidity proficiency samples. Calculation of data accuracy were made to ensure the accuracy of the onsite desktop turbidimeter used in the study. Accuracy ranged from 94 percent to 102 percent for turbidity proficiency samples analyzed during the Hydranautics ETV testing. Comparative calibration of on-line turbidimeters with the desktop turbidimeters were performed as corrective actions as needed. Accuracy calculations are presented in Appendix A.

#### ***4.7.5 Precision and Relative Percent Deviation***

Duplicate water quality samples were analyzed to determine the consistency of sampling and analysis using relative percent deviation. Calculations of relative percent deviation for duplicate samples are included in Appendix A of this report. The relative percent deviation for analyses not near the lower detection limit were within 15 percent for onsite analyses, within 51 percent for other general water quality analyses, and within 75 percent for microbial analyses. No data were rejected from the database.

## 4.8 Task 8: Microbial Removal

To demonstrate microbial removal by the Hydranautics UF system, two seeding experiments with MS2 bacterial virus were conducted. The two seeding experiments were conducted at the beginning of each test period, immediately after a membrane cleaning. The clean membrane condition provides worst case conditions for virus removal (Jacangelo et al. 1995, Montgomery Watson, 1997 and 1999). The virus were added to approximately 100 gallons (380 liter) of dechlorinated tap water in a 55 gallon polyethylene tank. A peristaltic pump was used to continuously add this virus stock solution to the membrane feed water. Seeding was started immediately after the completion of backwash. The system was allowed to run for one complete filtration cycle to reach equilibrium. After this, paired samples from the feed and filtrate were taken at the beginning, middle and end of the second and third filtration cycles, resulting in six samples per seeding experiment.

The feed and filtrate concentrations and log removal of virus during this seeding are presented in Table 4-8 and Figure 4-13. The membrane virus rejection ranged from 3.9 to 4.7 logs for the seeding conducted at the beginning of Test Period 1 and from 3.4 to 4.3 logs for the seeding conducted at the beginning of Test Period 2.

## 4.9 Additional ETV Program Requirements

### 4.9.1 *Operation and Maintenance (O&M) Manual*

The O&M manual for the Hydranautics UF system supplied by the manufacturer was reviewed during the ETV testing program. The review comments for the O&M manual are presented in Table 4-9. Overall, the review found the O&M manual to be a useful resource for the experienced membrane operator. The manual could be greatly improved by expanding the content, targeting a less technical audience and being organized into clearly identifiable sections and subsections. In addition, the manual should make more extensive use of tables and figures.

### 4.9.2 *System Efficiency and Chemical Consumption*

The efficiency of the small-scale Hydranautics UF system was calculated based on the electrical usage and water production of the system. The data are presented in Table 4-10. Overall, an efficiency of only 2.4 percent was calculated for the system, which is typical of many small-scale low pressure membrane systems.

The chemical consumption of the system was also estimated based on the operating criteria used during the ETV program. Table 4-11 provides a summary of the chemical consumption of the small-scale Hydranautics UF system.

### ***4.9.3 Equipment Deficiencies Experienced During the ETV Program***

#### **Test Period 1**

##### ***Hydranautics UF Membrane System***

Elevated filtrate particle counts with minimum particle counts of 10 particles/mL (>2 um) were noted on August 4, 1999. Because of possible contamination of the filtrate side of the system with algae, the raw water supply tank was chlorinated to 50 mg/L.

##### ***On-line Turbidimeters and Particle Counters***

Filtrate particle levels remained elevated on August 5, 1999. To alleviate potential degassing of the sample as it passed through the particle counter sample cell, a Hach bubble trap was installed just prior to the particle counter and on-line turbidimeter. Particle counts remained approximately 1 log higher than anticipated during Test Period 1, but generally tended to decrease over the course of the Test Period.

#### **Test Period 2**

##### ***Hydranautics UF Membrane System***

On February 28, 2000 the sodium hypochlorite feed pump became air bound. This had occurred a number of times during the start of Test Period 2 and because of this, the backwash chlorine concentration had been inconsistent during the start of Test Period 2. This is a common problem with sodium hypochlorite feed pumps, which operate intermittently since the solution tends to produce oxygen as it degrades and therefore can produce gas bubbles.

To solve the problem, the hypochlorite solution was diluted from 10 percent to 5 percent to allow the pump to operate at higher output, and two o-rings in the feed line leading to the chlorine positive displacement pump were replaced. After these changes were made, the backwash chlorine concentration was consistent and the system actually recovered specific flux for the remainder of Test Period 2. This change is also observed in the filtrate particle counts of Figure 4-8. There is a noticeable increase in the filtrate particle counts after the chlorine feed system begins operating reliably on February 28, 2000.

By February 29, 2000 the backwash flow rate had decreased. The backwash flow rate was increased to 35 gpm, which resulted in an increase in backwash volume from 21 to 25 gallons. This is also a potential reason for the recovery of specific flux and increased filtrate particle concentrations that occurred after this point in time.

A chronological listing of all problems experienced during ETV testing of the Hydranautics UF system, along with their associated corrective actions, is provided in Appendix A of this report.

#### **4.10 Inspection**

NSF conducted a site inspection of the Hydranautics ETV testing. A report based on this inspection is included in Appendix A.



## Chapter 5 References

- Adham, S.S., J.G. Jacangelo, and J-M. Laîné (1995). Low pressure membranes: assessing integrity, *Journal AWWA*, 87(3)62-75.
- APHA, AWWA and WPCF (1995). *Standard Methods for Examination of Water and Wastewater*. 19th ed. Washington, D.C. APHA.
- Jacangelo, J.G., S.S. Adham, and J-M. Laîné (1995). Mechanism of *Cryptosporidium*, *Giardia*, and MS2 virus removal by MF and UF, *Journal AWWA*, 87(9)107-121.
- Montgomery Watson (1997), *Membrane Prequalification Pilot Study*. Final Report prepared for the City of San Diego, October 1997.
- Montgomery Watson (1999), *California Department of Health Services Testing for Hydranautics Ultrafiltration Membrane*. Final Report prepared for Hydranautics, July 1999.
- Sobsey, M.D., Schwab, K.J., and Handzel, T.R. (1982) A simple membrane filter method to concentrate and enumerate male-specific RNA coliphages. *Jour AWWA*, (9):52-59.
- Shock, G. (1989). *Jour of Membrane Science*, (41):55-67.



**Tables and Figures**

**Table 2-1. Characteristics of the Hydranautics ultrafiltration membrane.**

	<b>Units</b>	<b>Value</b>
Commercial Designation		HYDRAcap™ - 40"
Approximate Size of Membrane Module	ft (m)	3.3 (1.0) length x 0.67 (0.20) diam
Active Membrane Area	ft <sup>2</sup> (m <sup>2</sup> )	270 (25)
Number of Fibers per Module		10,000
Number of Modules (Operational)		1
Inside Diameter of Fiber	inch (mm)	0.031 (0.8)
Outside Diameter of Fiber	inch (mm)	0.051 (1.3)
Approximate Length of Fiber	ft (m)	3.1 (0.94) active
Flow Direction		inside-out
Nominal Molecular Weight Cutoff	Daltons	150,000
Absolute Molecular Weight Cutoff	Daltons	na <sup>[1]</sup>
Nominal Membrane Pore Size	micron	0.01
Absolute Membrane Pore Size	micron	na
Membrane Material/Construction		Poly Ether Sulfone (PES)
Membrane Surface Characteristics		Hydrophilic
Membrane Charge		Neutral
Design Operating Pressure	psi	20-30
Design Flux at Design Pressure	gfd (l/hr-sq m)	75 (127)
Maximum Transmembrane Pressure	psi (bar)	20 (1.4)
Standard Testing pH		6-8
Standard Testing Temperature	degF (degC)	59-68 (15-20)
Acceptable Range of Operating pH Values		2-13
Acceptable Range of Operating Temperatures	degF (degC)	34 - 100 (1 - 40)
Maximum Permissible Turbidity	NTU	~75 feed max
Chlorine/Oxidant Tolerance	ppm	100 (free chlorine)

[1] na = not available

**Table 3-1. Water quality analytical methods.**

<b>Parameter</b>	<b>Facility</b>	<b>Standard Method</b>
<b>General Water Quality</b>		
pH	On-Site	4500H+
Alkalinity	Laboratory	2320 B
Total Hardness	Laboratory	2340 C
Calcium Hardness	Laboratory	3500Ca D
Temperature	On-Site	2550 B
Total Suspended Solids	Laboratory	2540 D
Total Dissolved Solids	Laboratory	2540 C
<b>Particle Characterization</b>		
Turbidity (Bench-Top)	On-Site	2130 B
Turbidity (On-Line)	On-Site	Manufacturer
Particle Counts (On-Line)	On-Site	Manufacturer
<b>Organic Material Characterization</b>		
TOC and DOC	Laboratory	5310 B
UV Absorbance at 254 nm	Laboratory	5910 B
<b>Microbiological Analyses</b>		
Total Coliform	Laboratory	9221 B
HPC Bacteria	Laboratory	9215 B
MS2 Virus	Laboratory	EPA ICR Method for Coliphage Assay

**Table 4-1. Hydranautics UF membrane system operating conditions.**

Parameter	Unit			
Test Period		1	1	2
Run		1-1	1-2	2-1 <sup>[1]</sup>
Start Date & Time		8/3/99 10:43	8/12/99 15:03	2/16/00 10:58
End Date & Time		8/12/99 8:38	9/13/99 9:20	3/21/00 10:25
Run Length	days hrs	8 days 22 hrs	31 days 18 hrs	30 days 16 hrs
Run Terminating Condition		Fouled	Time	Time
Filter Cycle Length	min	19	19	19
Feed Flow	gpm (lpm)	13 (49)	13 (49)	13 (49)
Concentrate Flow	gpm (lpm)	0 (0)	0 (0)	0 (0)
Filtrate Flow	gpm (lpm)	13 (49)	13 (49)	13 (49)
Operating Flux	gfd (L/hr-sq m)	69 (115)	69 (115)	69 (115)
Backwash Cycle Length	sec	65	65	65
Backwash Filtrate Consumed	gal (liter)	30 (114)	31 (117)	25 (95)
Forward Flush Feedwater Consumed	gal (liter)	7 (26)	7 (26)	7 (26)
Backwash Chlorine Dose	mg/L	10-15	15-20	15-20
Feed Water Recovery	%	85%	85%	87%

<sup>[1]</sup> System down starting 2/20/00 7:00 for 3.3 days because of broken raw water supply line.

**Table 4-2. Evaluation of cleaning efficiency for the Hydranautics UF membrane.**

Clean Number	Clean Date	Specific Flux @20degC Before Clean Jsf gfd/psi (l/hr-m2-bar)	Specific Flux @20degC After Clean Jsi gfd/psi (l/hr-m2-bar)	Recovery of Specific Flux 100(1 - Jsf / Jsi) %	Loss of Original Specific Flux 100(1-(Jsi / Jsio)) %
Start	8/3/99	---	<b>13 (330)</b>	---	---
1-1	8/12/99	3.1 (77)	12 (300)	74	9.8
1-2	9/13/99	8.5 (210)	12 (300)	31	8.3
2-2	3/21/00	7.7 (190)	14 (350)	45	-7.7

**Table 4-3. Onsite lab water quality analyses for the Hydranautics UF membrane system.**

Parameter	Unit	Count	Median	Range	Average	Standard Deviation	95 Percent Confidence Interval
<b>TEST PERIOD 1</b>							
<b>Raw Water</b>							
pH		27	8.3	8.0 - 8.3	8.2	0.091	8.2 - 8.2
Desktop Turbidity	NTU	58	1.4	0.70 - 2.5	1.4	0.37	1.3 - 1.5
Temperature	degC	58	31	21 - 36	30	4.4	29 - 31
<b>Filtrate</b>							
Desktop Turbidity	NTU	29	0.050	0.050 - 0.10	0.050	0.0093	0.050 - 0.050
<b>Backwash Waste</b>							
Desktop Turbidity	NTU	57	14	2.5 - 24	14	3.9	13 - 15
<b>TEST PERIOD 2</b>							
<b>Raw Water</b>							
pH		22	8.3	7.9 - 8.4	8.2	0.15	8.1 - 8.3
Desktop Turbidity	NTU	42	1.3	1.0 - 2.0	1.3	0.20	1.2 - 1.4
Temperature	degC	42	16	13 - 21	17	2.0	16 - 18
<b>Filtrate</b>							
Desktop Turbidity	NTU	22	0.050	0.050 - 0.050	0.050	0.00	0.050 - 0.050
<b>Backwash Waste</b>							
Desktop Turbidity	NTU	42	7.8	3.9 - 17	8.0	2.1	7.4 - 8.6

**Table 4-4. Summary of on-line particle and turbidity data for the Hydranautics UF membrane system.**

Parameter	Unit	Count	Median	Range	Average	Standard Deviation	95 Percent Confidence Interval
<b>TEST PERIOD 1</b>							
<b>Raw Water</b>							
Turbidity	ntu	238	1.4	0.55 - 2.0	1.4	0.35	1.4 - 1.4
> 2 um Particles	#/mL	238	7600	3200 - 12000	7700	1800	7500 - 7900
2-3 um Particles	#/mL	238	3800	1900 - 5500	3800	760	3700 - 3900
3-5 um Particles	#/mL	238	2400	890 - 4000	2500	690	2400 - 2600
5-15 um Particles	#/mL	238	1400	410 - 2300	1400	410	1300 - 1500
>15 um Particles	#/mL	238	62	26 - 160	66	24	63 - 69
<b>Filtrate</b>							
Turbidity	ntu	237	0.050	0.050 - 0.10	0.050	0.00	0.050 - 0.050
> 2 um Particles	#/mL	234	4.9	1.9 - 280	12	25	8.8 - 15
2-3 um Particles	#/mL	234	1.4	0.55 - 65	3.2	6.6	2.4 - 4.0
3-5 um Particles	#/mL	234	1.6	0.60 - 110	4.0	9.4	2.8 - 5.2
5-15 um Particles	#/mL	234	1.7	0.65 - 100	4.2	9.2	3.0 - 5.4
>15 um Particles	#/mL	234	0.050	0.050 - 2.6	0.15	0.25	0.12 - 0.18
Log Removal 2-3 um Particles		40	3.4	2.0 - 3.7	3.2	0.40	3.1 - 3.3
Log Removal 3-5 um Particles		40	3.1	1.6 - 3.4	3.0	0.35	2.9 - 3.1
Log Removal 5-15 um Particles		40	2.7	1.4 - 3.2	2.7	0.40	2.6 - 2.8
Log Removal >15 um Particles		40	3.0	1.5 - 3.4	2.9	0.45	2.8 - 3.0
<b>TEST PERIOD 2</b>							
<b>Raw Water</b>							
Turbidity	ntu	190	1.2	0.95 - 2.0	1.3	0.20	1.3 - 1.3
> 2 um Particles	#/mL	188	5100	3700 - 8100	5300	890	5200 - 5400
2-3 um Particles	#/mL	188	2700	1900 - 4000	2700	370	2600 - 2800
3-5 um Particles	#/mL	188	1600	1200 - 2700	1700	300	1700 - 1700
5-15 um Particles	#/mL	188	800	520 - 2500	870	240	840 - 900
>15 um Particles	#/mL	188	21	11 - 180	26	16	24 - 28
<b>Filtrate</b>							
Turbidity	ntu	185	0.050	0.050 - 0.050	0.050	0.00	0.050 - 0.050
> 2 um Particles	#/mL	186	0.90	0.45 - 32	1.2	2.5	0.84 - 1.6
2-3 um Particles	#/mL	186	0.45	0.20 - 14	0.55	1.0	0.41 - 0.69
3-5 um Particles	#/mL	186	0.30	0.15 - 9.3	0.35	0.70	0.25 - 0.45
5-15 um Particles	#/mL	186	0.20	0.10 - 7.9	0.30	0.60	0.21 - 0.39
>15 um Particles	#/mL	186	0.050	0.050 - 0.75	0.050	0.050	0.043 - 0.057
Log Removal 2-3 um Particles		32	3.8	2.7 - 4.2	3.7	0.30	3.6 - 3.8
Log Removal 3-5 um Particles		32	3.8	2.5 - 4.0	3.7	0.30	3.6 - 3.8
Log Removal 5-15 um Particles		32	3.6	2.3 - 3.8	3.5	0.30	3.4 - 3.6
Log Removal >15 um Particles		32	2.6	2.1 - 3.0	2.6	0.20	2.5 - 2.7

**Table 4-5. Summary of the microbial water quality analyses for the Hydranautics UF membrane system.**

Parameter	Unit	Count	Median	Range	Average	Standard Deviation	95 Percent Confidence Interval
<b>TEST PERIOD 1</b>							
<b>Raw Water</b>							
Total Coliforms	MPN/100mL	4	<2	<2 - 23	7	11	<2 - 18
HPC	cfu/mL	4	395	180 - 800	443	263	185 - 700
<b>Filtrate</b>							
Total Coliforms	MPN/100mL	4	<2	<2 - <2	<2	0	<2 - <2
HPC	cfu/mL	4	1	<1 - 4	2	2	<1 - 3
<b>Backwash Waste</b>							
Total Coliforms	MPN/100mL	4	<2	<2 - 13	5	6	<2 - 10
<b>TEST PERIOD 2</b>							
<b>Raw Water</b>							
Total Coliforms	MPN/100mL	5	4	<2 - 17	7	7	<2 - 13
HPC	cfu/mL	5	79	1 - 150	82	62	27 - 136
<b>Filtrate</b>							
Total Coliforms	MPN/100mL	5	<2	<2 - <2	<2	0	<2 - <2
HPC	cfu/mL	5	<1	<1 - 2	1	1	1 - 2
<b>Backwash Waste</b>							
Total Coliforms	MPN/100mL	5	8	2 - 23	7	3	4 - 10

Note: All calculations with below detection limit values used the detection limit value in the calculation as a conservative estimate.



**Table 4-6. Summary of general water quality analyses for the Hydranautics UF membrane system.**

Parameter	Unit	Count	Median	Range	Average	Standard Deviation	95 Percent Confidence Interval
<b>TEST PERIOD 1</b>							
<b>Raw Water</b>							
Alkalinity	mg/L as CaCO <sub>3</sub>	4	120	120 - 120	120	3.6	120 - 120
Total Hardness	mg/L as CaCO <sub>3</sub>	1	250	250 - 250	250	undefined	undefined
Calcium Hardness	mg/L as CaCO <sub>3</sub>	2	150	150 - 150	150	undefined	undefined
Total Suspended Solids	mg/L	4	2.9	2.5 - 6.4	3.7	1.8	1.9 - 5.5
Total Dissolved Solids	mg/L	4	500	490 - 510	500	7.1	490 - 510
TOC	mg/L	1	3.3	3.3 - 3.3	3.3	undefined	undefined
DOC	mg/L	1	2.4	2.4 - 2.4	2.4	undefined	undefined
UV254 Unfiltered	/cm	3	0.075	0.072 - 0.079	0.075	0.0035	0.071 - 0.079
UV254 Filtered	/cm	4	0.067	0.059 - 0.069	0.065	0.0045	0.061 - 0.069
<b>Filtrate</b>							
Alkalinity	mg/L as CaCO <sub>3</sub>	4	120	120 - 120	120	2.6	120 - 120
Total Hardness	mg/L as CaCO <sub>3</sub>	1	240	240 - 240	240	undefined	undefined
Calcium Hardness	mg/L as CaCO <sub>3</sub>	2	150	150 - 160	150	undefined	undefined
Total Suspended Solids	mg/L	4	< 1.0	< 1.0 - < 2.0	<1.2	0.50	<0.71 - <1.7
Total Dissolved Solids	mg/L	4	510	490 - 510	500	9.6	490 - 510
TOC	mg/L	3	2.6	2.2 - 2.7	2.5	0.24	2.2 - 2.8
DOC	mg/L	1	2.2	2.2 - 2.2	2.2	undefined	undefined
UV254 Unfiltered	/cm	4	0.062	0.059 - 0.065	0.062	0.0026	0.059 - 0.065
<b>Backwash Waste</b>							
Total Suspended Solids	mg/L	4	21	14 - 36	23	9.3	14 - 32
<b>TEST PERIOD 2</b>							
<b>Raw Water</b>							
Alkalinity	mg/L as CaCO <sub>3</sub>	6	120	120 - 120	120	1.4	120 - 120
Total Hardness	mg/L as CaCO <sub>3</sub>	6	220	210 - 220	220	5.1	220 - 220
Calcium Hardness	mg/L as CaCO <sub>3</sub>	6	140	130 - 150	140	5.8	140 - 140
Total Suspended Solids	mg/L	5	9.9	3.9 - 13	8.9	3.8	5.6 - 12
Total Dissolved Solids	mg/L	6	480	470 - 500	480	10	470 - 490
TOC	mg/L	6	3.5	2.5 - 3.7	3.3	0.43	3.0 - 3.6
DOC	mg/L	4	3.1	2.3 - 3.7	3.1	0.69	2.4 - 3.8
UV254 Unfiltered	/cm	6	0.073	0.060 - 0.078	0.071	0.0068	0.066 - 0.076
UV254 Filtered	/cm	6	0.065	0.061 - 0.068	0.065	0.0026	0.063 - 0.067
<b>Filtrate</b>							
Alkalinity	mg/L as CaCO <sub>3</sub>	6	120	120 - 120	120	0.82	120 - 120
Total Hardness	mg/L as CaCO <sub>3</sub>	6	220	210 - 230	220	6.0	220 - 220
Calcium Hardness	mg/L as CaCO <sub>3</sub>	6	130	130 - 150	140	4.9	140 - 140
Total Suspended Solids	mg/L	6	< 1.0	< 1.0 - < 1.0	<1.0	0.00	<1.0 - <1.0
Total Dissolved Solids	mg/L	1	490	490 - 490	490	undefined	undefined
TOC	mg/L	6	3.4	2.4 - 3.7	3.2	0.55	2.8 - 3.6
DOC*	mg/L	4	3.5	3.0 - 3.8	3.5	0.40	3.1 - 3.9
UV254 Unfiltered	/cm	6	0.067	0.054 - 0.072	0.064	0.0073	0.058 - 0.070
<b>Backwash Waste</b>							
Total Suspended Solids	mg/L	5	9.3	5.8 - 14	9.5	3.0	6.9 - 12

Note: All calculations involving results with below detection limit values used the detection limit value in the calculations as a conservative estimate.

\*The average and median TOC value was lower relative to the DOC because for one sample set on March 8, 2000, the TOC result was 2.55 mg/l and there was no reported result for DOC. In addition, there are other possible reasons for average DOC being lower than TOC such as improper rinsing of the filter paper, transcription or data entry error, or sample bottle contamination.

**Table 4-7. Comparison of calculated and measured total suspended solids for the Hydranautics UF membrane system.**

Date	Filtrate Flow (gpm)	Filtration Cycle Length (min)	Volume Filtered (gal)	Forward Flush Volume (gal)	Backwash Volume (gal)	Measured Raw TSS (mg/L)	Measured Backwash TSS (mg/L)	Calculated Backwash TSS (mg/L)
<b>TEST PERIOD 1</b>								
8/10/99	13	19	247	7	30	2.6	36	68
8/16/99	13	19	247	7	30	6.4	23	166
8/23/99	13	19	247	7	30	2.5	19	65
8/31/99	13	19	247	7	30	3.2	14	83
<b>TEST PERIOD 2</b>								
2/28/00	13	19	247	7	25	9.9	13.7	297
3/1/00	13	19	247	7	25	12.0	9	361
3/8/00	13	19	247	7	25	12.7	11	382
3/15/00	13	19	247	7	25	3.9	8	117

**Table 4-8. Feed and filtrate concentrations of MS2 virus for the Hydranautics UF membrane system.**

**Seeding #1**

Seeding Date: 8/2/99

Specific Flux at 20 degC = 14.8 gfd/psi (364 L/hr-m2-bar)

Feed Conc. (pfu/100mL)	Filtrate Conc. (pfu/100mL)	Log Removal
1.7E+8	3.6E+3	4.7
4.5E+7	4.5E+3	4.0
5.8E+7	3.8E+3	4.2
5.2E+7	2.0E+3	4.4
2.8E+7	3.4E+3	3.9
3.6E+7	3.8E+3	4.0

**Seeding #2**

Seeding Date: 2/16/00

Specific Flux at 20 degC = 16.3 gfd/psi (400.7 L/hr-m2-bar)

Feed Conc. (pfu/100mL)	Filtrate Conc. (pfu/100mL)	Log Removal
5.7E+7	1.3E+4	3.6
5.7E+7	1.7E+4	3.5
9.3E+7	2.0E+4	3.7
4.5E+7	1.7E+4	3.4
1.1E+8	5.7E+3	4.3
6.4E+7	6.4E+3	4.0

**Table 4-9. Review of manufacturer’s operations and maintenance manual for the Hydranautics UF membrane system.**

O & M Manual	Grade	Comment
Overall Organization	-	<ul style="list-style-type: none"> <li>The O&amp;M manual is well organized overall. The manual is brief and contains no table of contents. Manual sections are labeled with tabbed dividers and include operation, cleaning, plc code, electrical and appendix containing manufacturers information sheets for package system components</li> <li>Includes a section with a printout of the PLC code. This information would not be useful to the typical package system operator</li> </ul>
Operations Sections	+	<ul style="list-style-type: none"> <li>Includes a bulleted list of the operational limits of the HYDRAcap membrane</li> <li>Includes a numbered list of the major components of the package system such as pumps and valves</li> <li>Includes schematics showing open valves and water flow during filtration modes and each backwash step. Includes a good description of the backwash steps, but the individual backwash steps are not identified as subheadings of the backwash section by indentation or section numbering, making the organization less clear</li> <li>Contains a table listing all automatic valves and their on/off position during each of the filtration modes and backwash steps</li> <li>Lists typical backwash frequencies</li> <li>Does not contain an explanation of how to modify settings on the PLC</li> <li>The operation section is an adequate technical reference for experienced membrane system users</li> <li>Manual includes a cleaning section with an adequate description of the membrane cleaning procedure</li> <li>No information on system startup or shutdown</li> </ul>
Maintenance Section	-	<ul style="list-style-type: none"> <li>Includes no maintenance section</li> </ul>
Alarms	-	<ul style="list-style-type: none"> <li>Includes no discussion of alarm conditions</li> </ul>
Troubleshooting	-	<ul style="list-style-type: none"> <li>Manual does not include a troubleshooting section</li> </ul>
Ancillary Equipment Information	+	<ul style="list-style-type: none"> <li>Component equipment manufacturers and model numbers are included in the O&amp;M manual</li> </ul>
Drawings and Schematics	+	<ul style="list-style-type: none"> <li>Includes crude schematics of water flows and valve positions during all operating modes</li> <li>Includes electrical diagrams as a separate section to the manual</li> </ul>

**Table 4-9. Continued.**

O & M Manual	Grade	Comment
Use of Tables	+	<ul style="list-style-type: none"> <li>Manual makes limited use of tables including table showing valve open/close positions for all filtration modes and backwash steps</li> </ul>
OVERALL COMMENT	+	<ul style="list-style-type: none"> <li>Overall, an acceptable O&amp;M manual for the experienced membrane pilot operator.</li> <li>The manual should target a less technical audience, improve the organization and expand the content of the O&amp;M manual. The manual should include a table of contents. It should be organized hierarchically with sections and sub-sections clearly identifiable. It should include information on system startup and shutdown procedures as well as alarm conditions and troubleshooting guide</li> <li>The manual should make better use of graphics and tables integrated with text to make a more readable document and to assist the reader's understanding</li> </ul>

Note: Grade of "+" indicates acceptable level of detail and presentation, grade of "-" indicates the manual would benefit from improvement in this area.

**Table 4-10. Efficiency of Hydraulics UF membrane system.**

Parameter	Unit	Value
<b>ELECTRICAL USE</b>		
Voltage	Volt - three phase	220
Feed Pump Current	Amp	2.8
Feed Pump Power	Watt	1100
<b>WATER PRODUCTION</b>		
Transmembrane Pressure	psi Pa	4.6 3.2E+04
Flow Rate	gpm m3/s	13 8.2E-04
Power	Watt	26
<b>EFFICIENCY</b>	%	<b>2.4%</b>

**Table 4-11. Chemical consumption for the Hydranautics UF membrane system.**

	Unit	Value
<b>Backwash Chlorine</b> <sup>[1]</sup>		
Average Chlorine Dose	mg/L	18
Stock Chlorine Concentration	%	10
Average Backwash Volume	gal (L)	28 (110)
Chlorine Stock Volume per Backwash	mL	19
Backwash Per Day	#	72
Stock Chlorine Use Per Day	Gal (L)	0.36 (1.4)
<b>Cleaning Chemicals</b> <sup>[2]</sup>		
Citric Acid	lb (kg)	4.0 (1.8)
Caustic Soda (50% NaOH)	Gal (L)	0.29 (1.1)
Muriatic Acid (40% HCl)	Gal (L)	0.053 (0.20)

<sup>[1]</sup> Based on average chlorine dose and average backwash volume

<sup>[2]</sup> Typical chemical consumption per cleaning

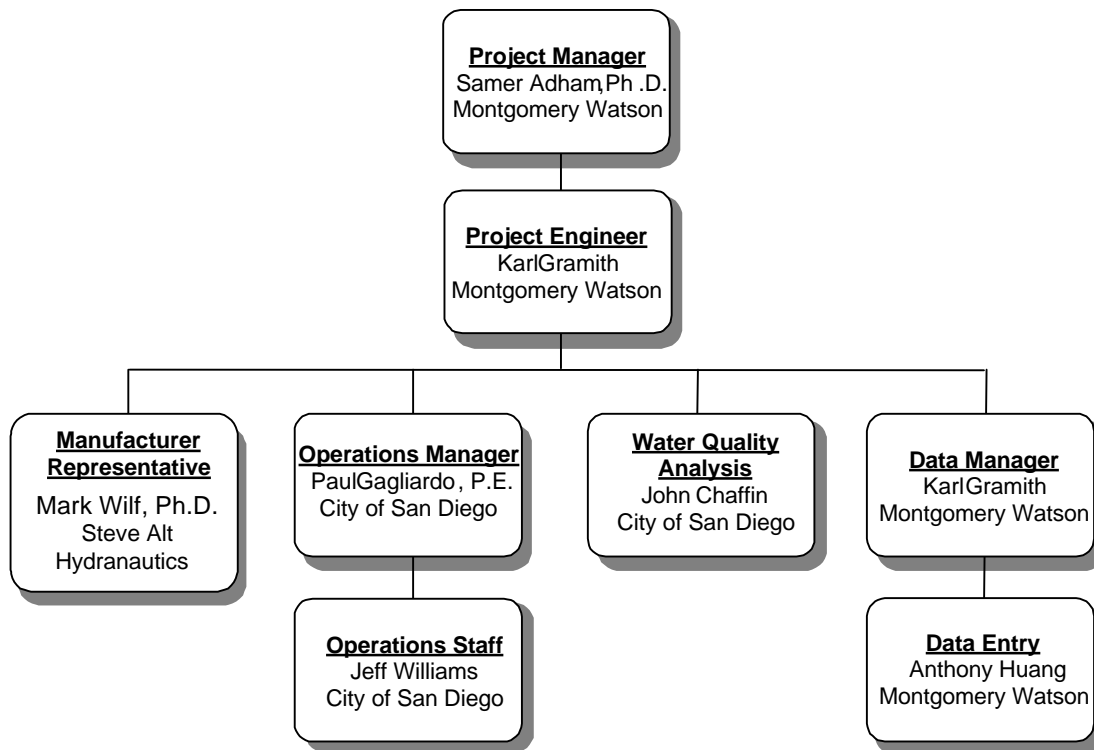

Figure 1-1. Organizational chart showing lines of communication.



Figure 2-1. Photograph of the Hydranautics UF test unit.



**PLAN VIEW**

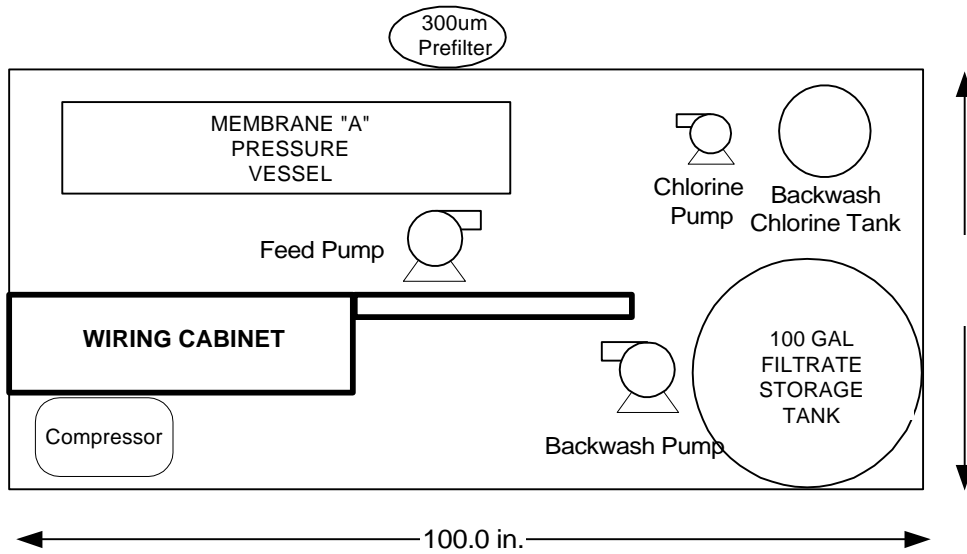

**SIDE VIEW**

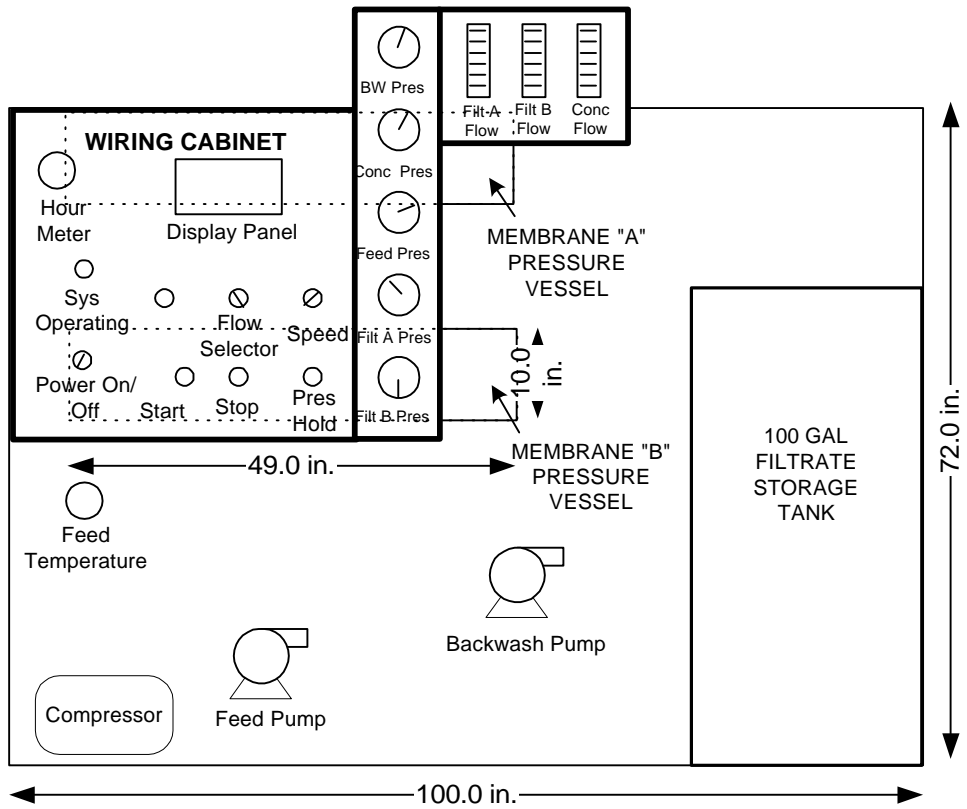

Figure 2-2. Spatial requirements for the Hydranautics UF unit.

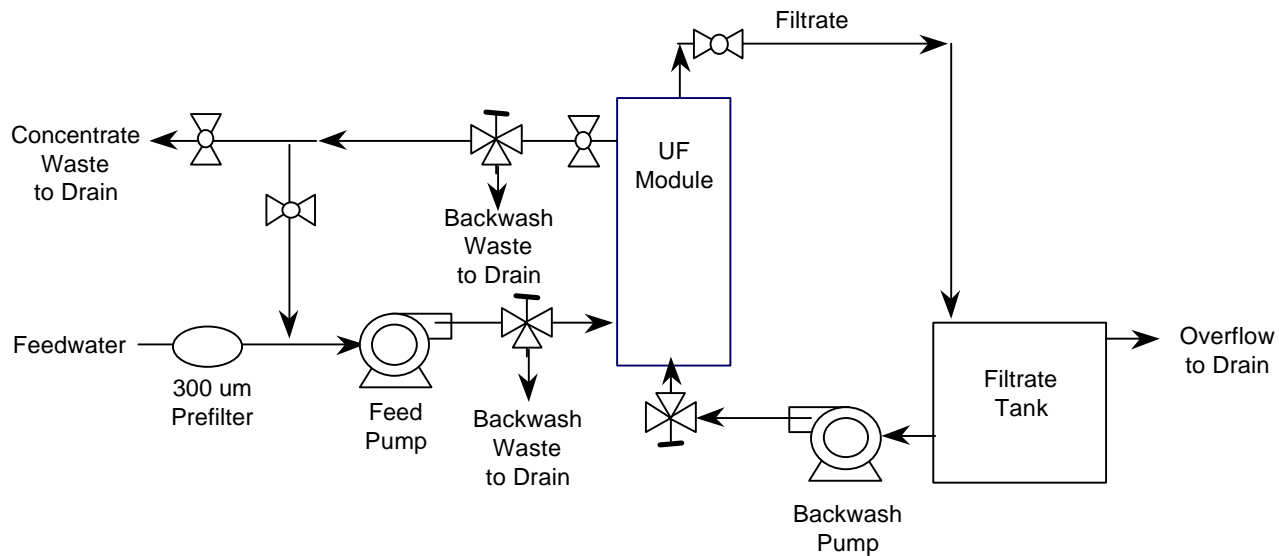

Figure 2-3. Schematic diagram of the Hydranautics UF membrane process.

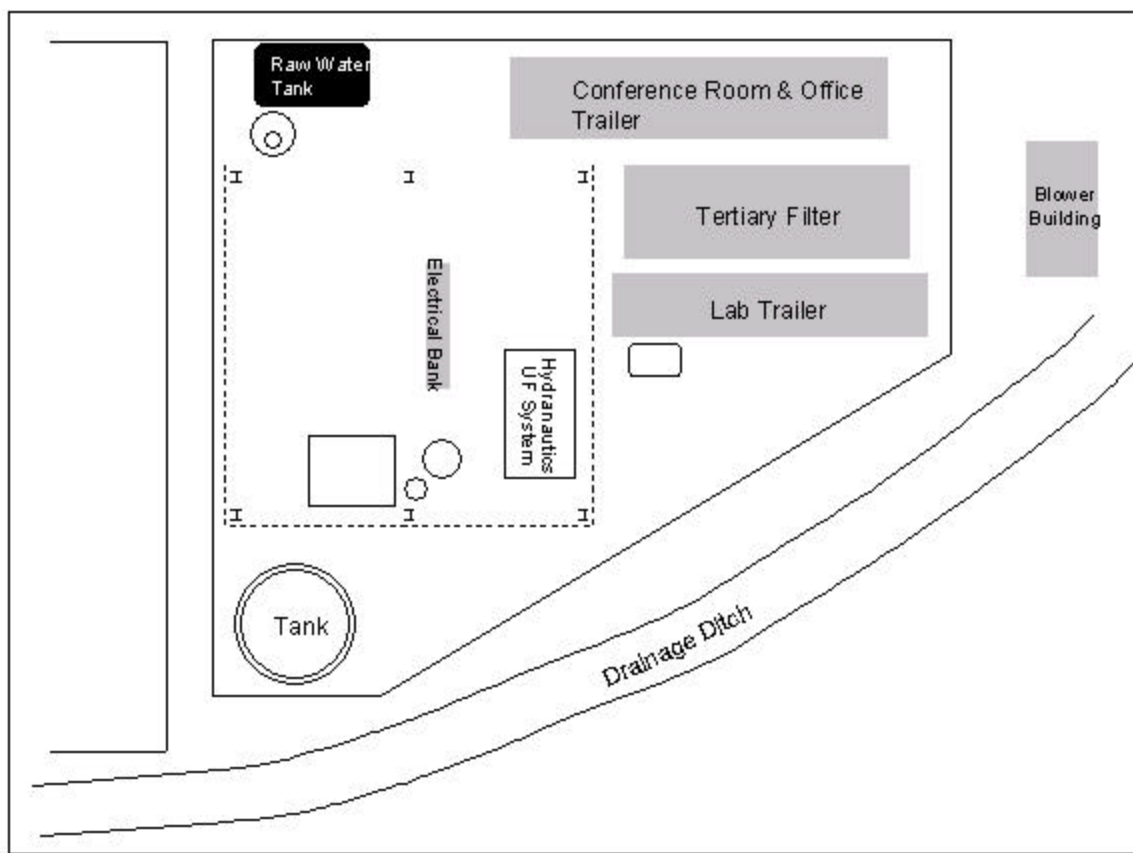

Figure not drawn to scale.

Figure 3-1. Schematic of Aqua 2000 Research Center test site.

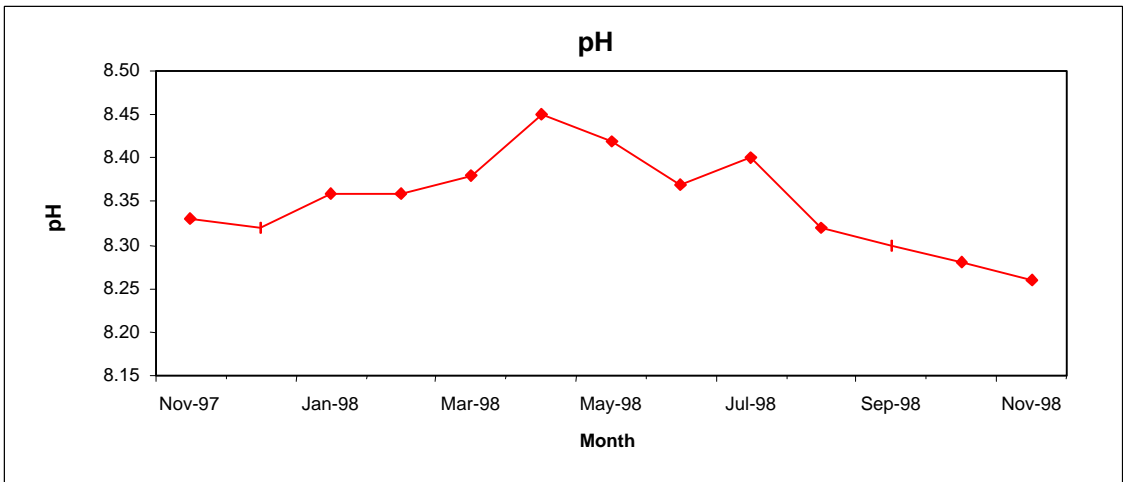
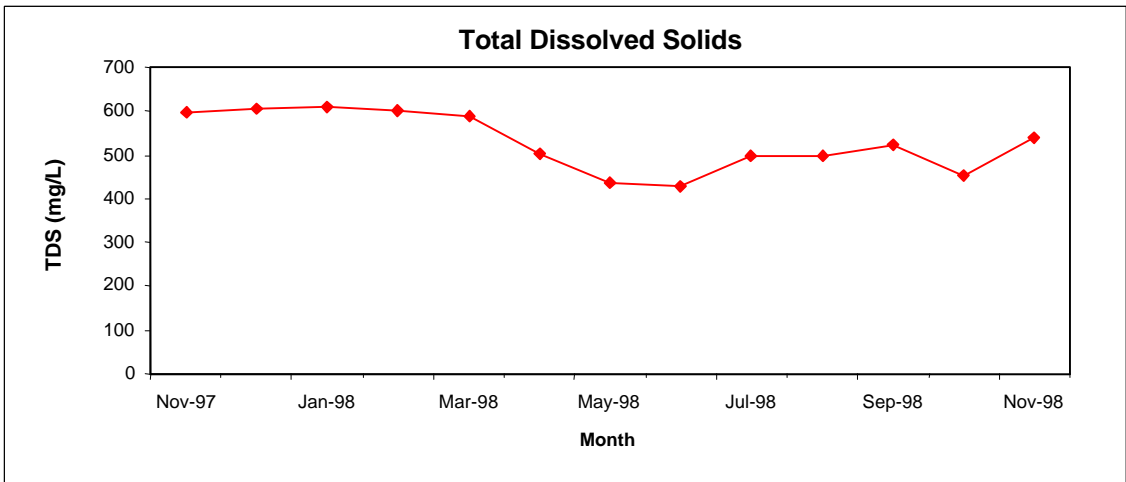
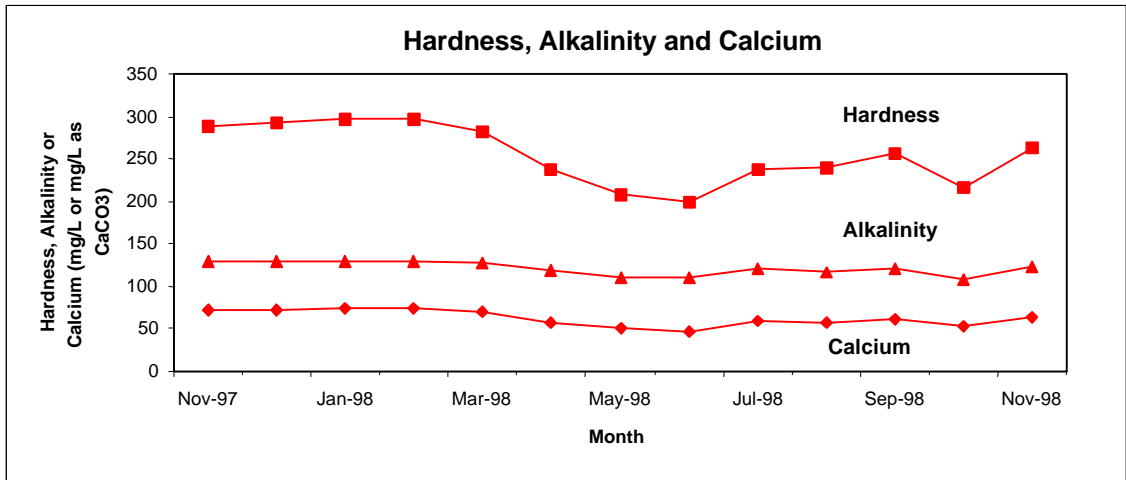

Figure 3-2. Lake Skinner raw water quality.

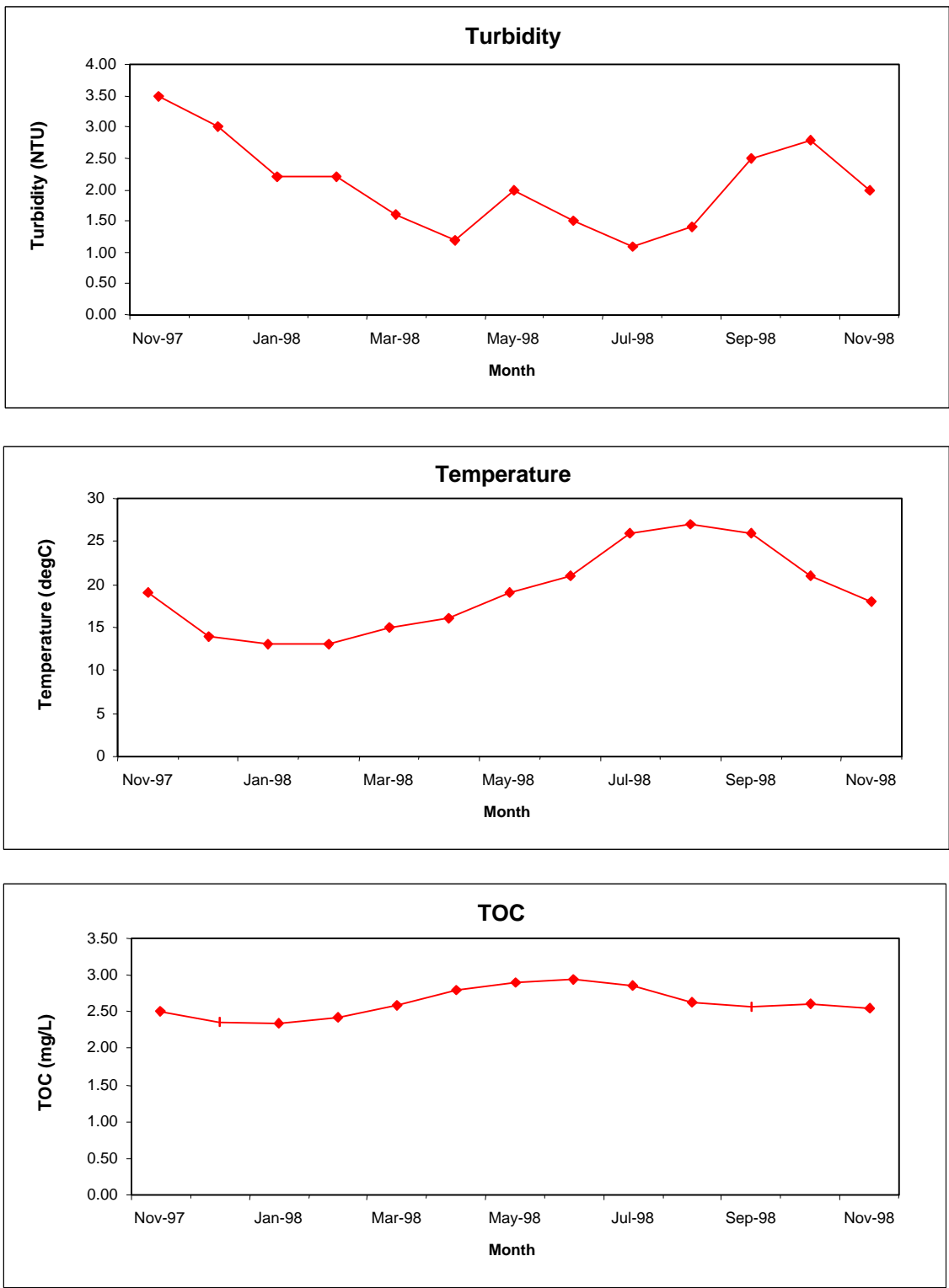

Figure 3-3. Lake Skinner raw water quality.

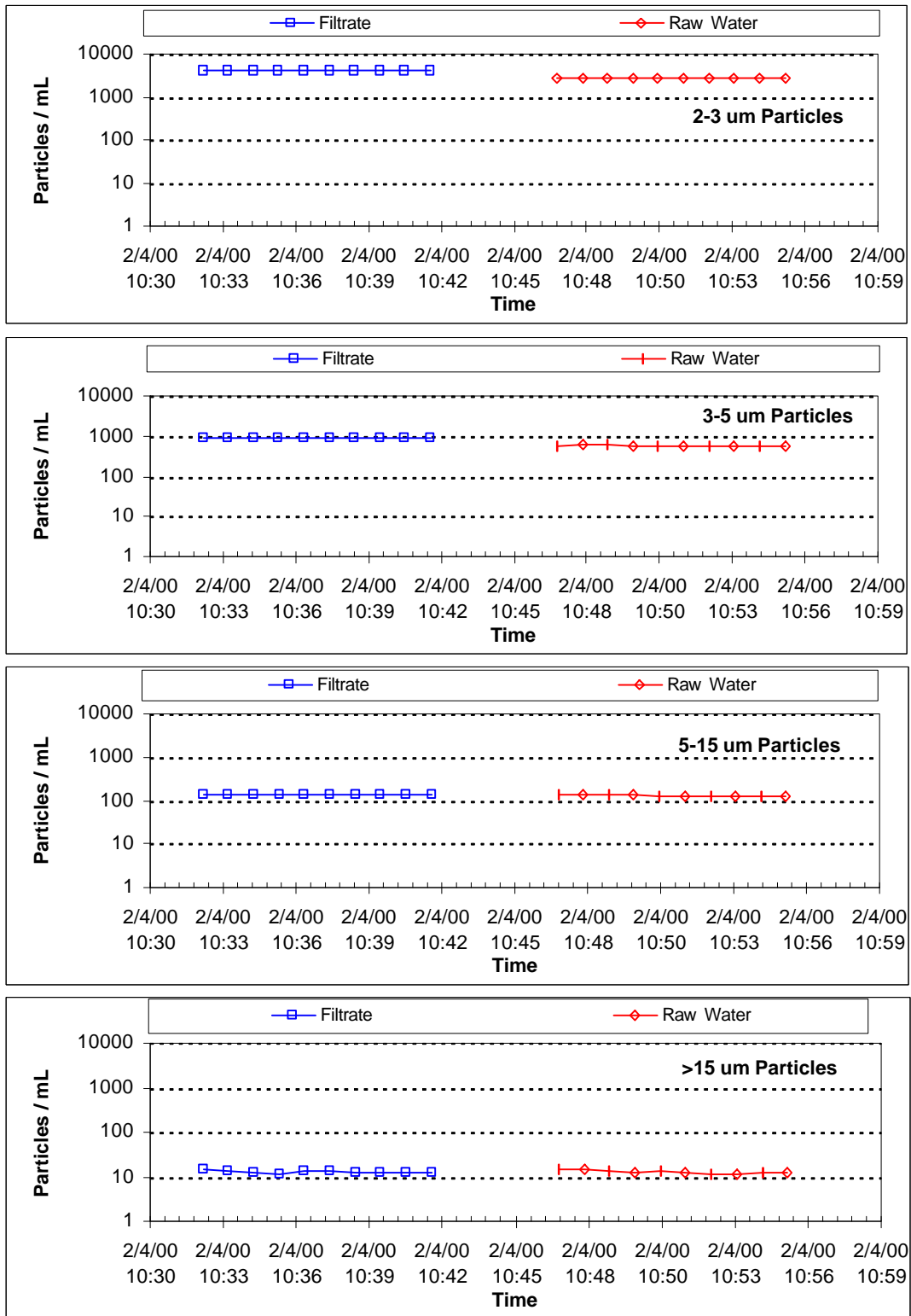

Figure 3-4. Response of on-line particle counters to Duke Monosphere Solution.

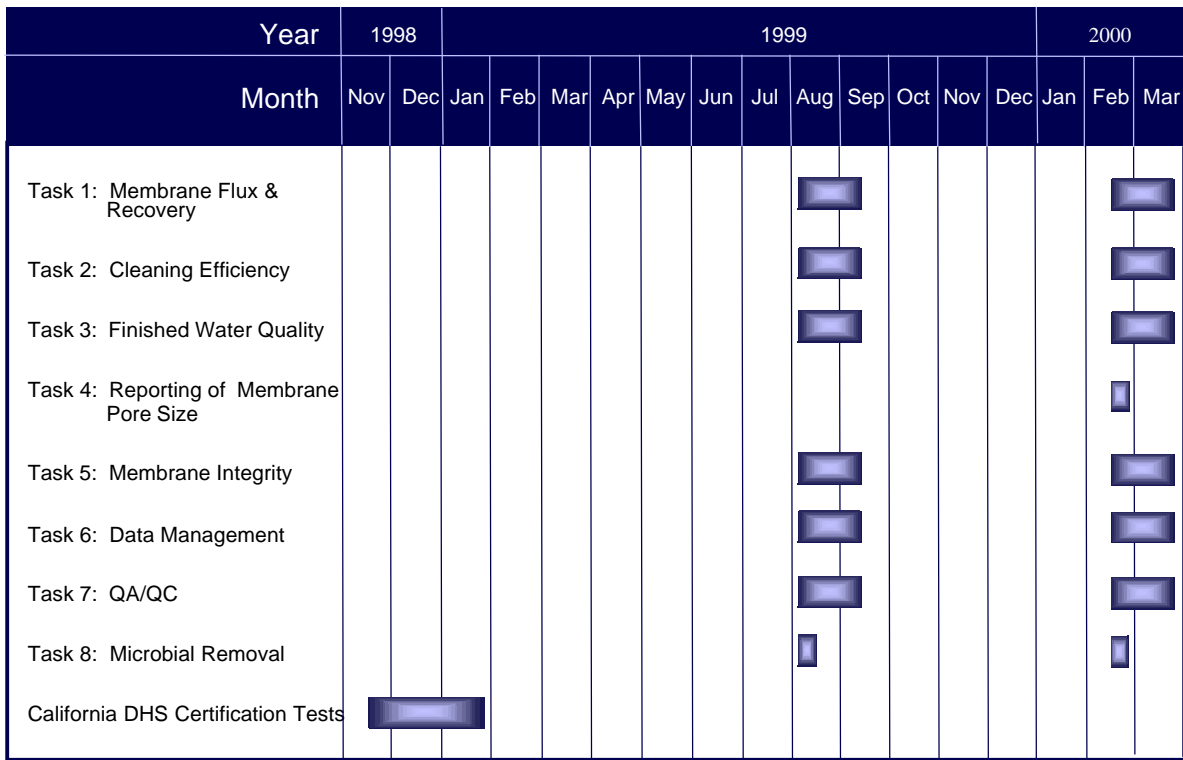
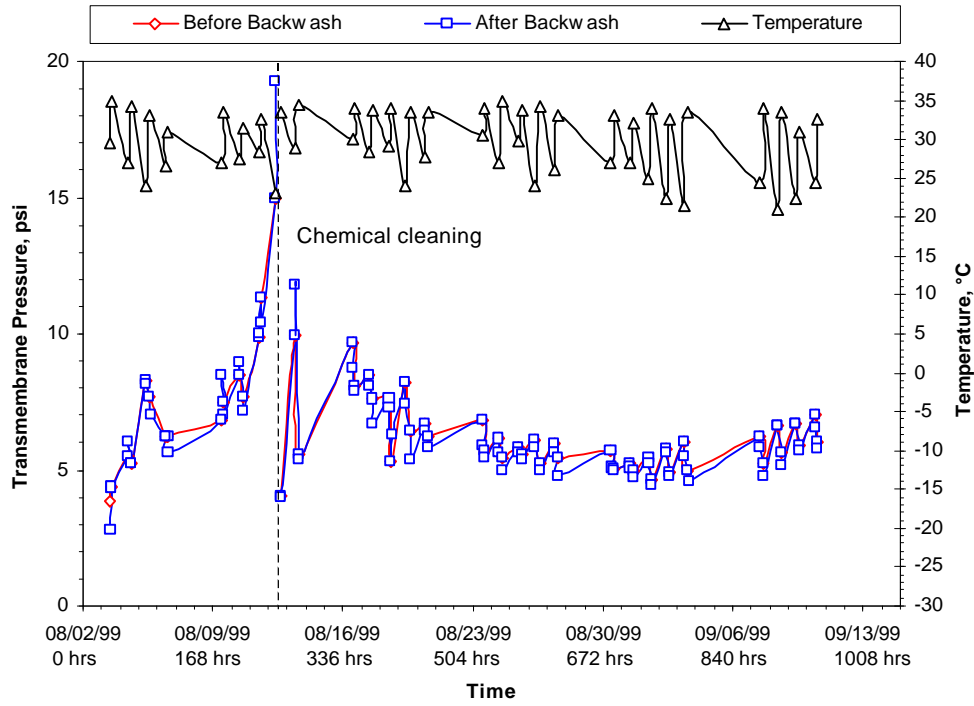
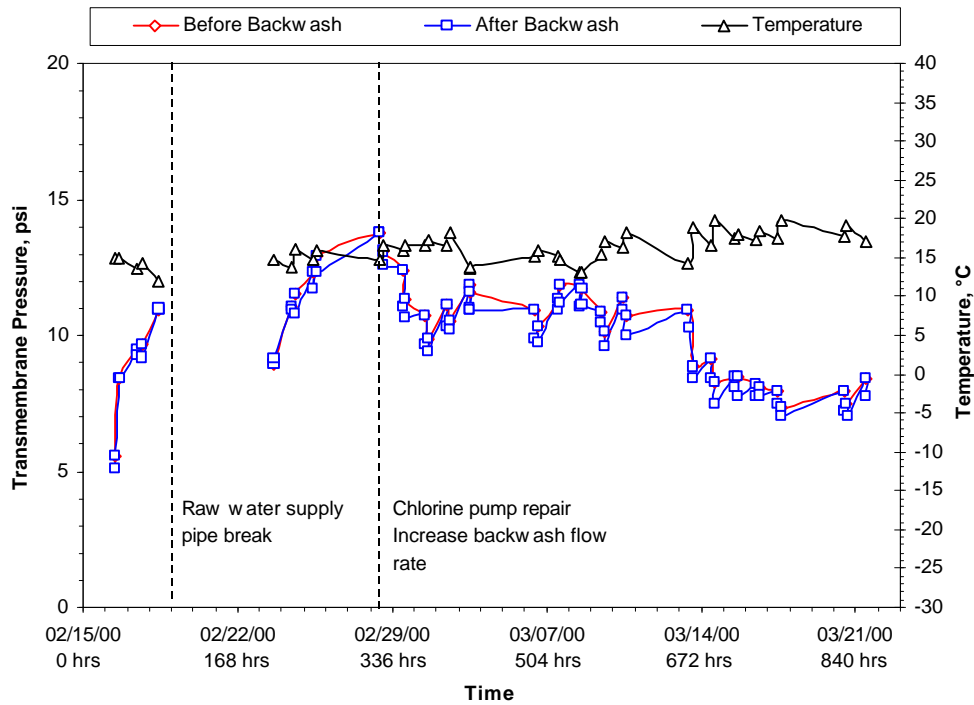

Figure 3-5. Membrane verification testing schedule.



A - Test Period 1.



B - Test Period 2.

Figure 4-1. Transmembrane pressure and temperature profiles for the Hydranautics UF membrane system.



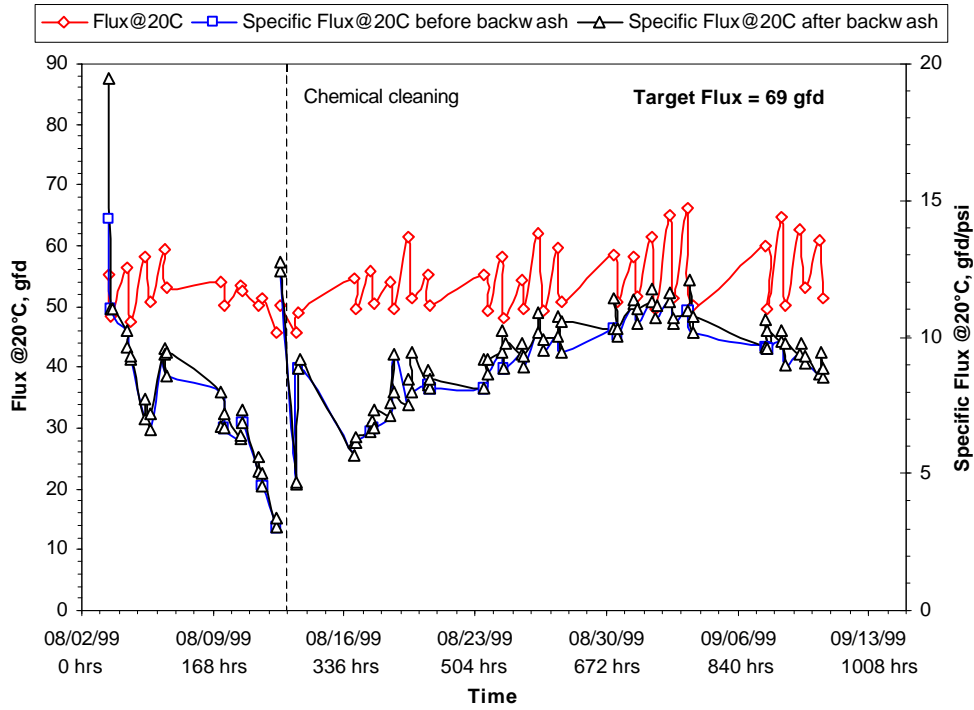

A - Test Period 1.

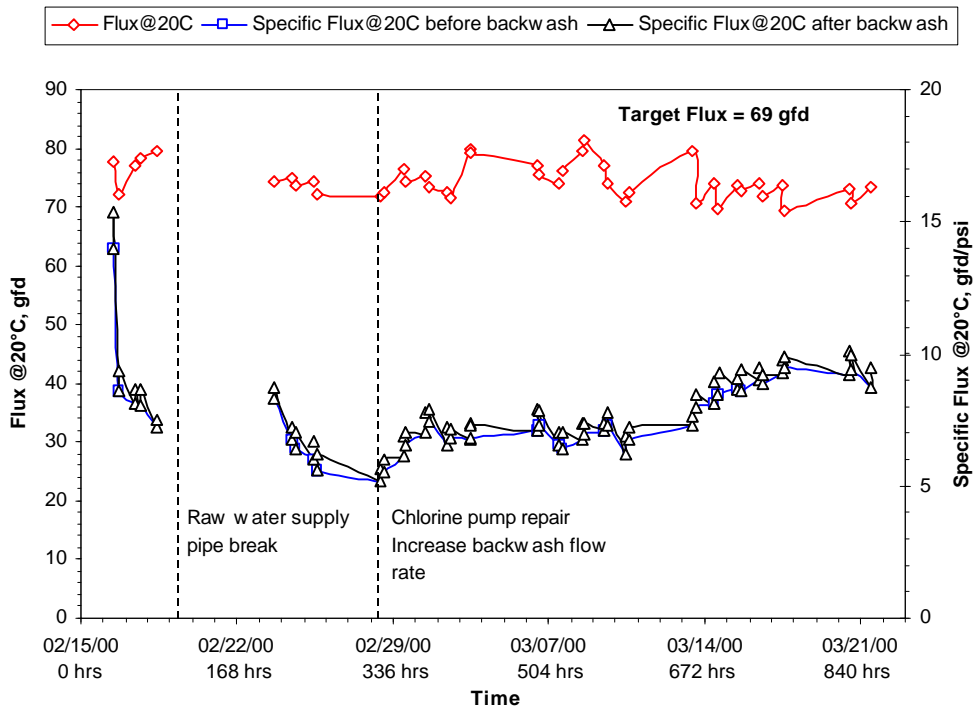

B - Test Period 2.

Figure 4-2. Operational flux and specific flux profiles for the Hydranautics UF membrane system.

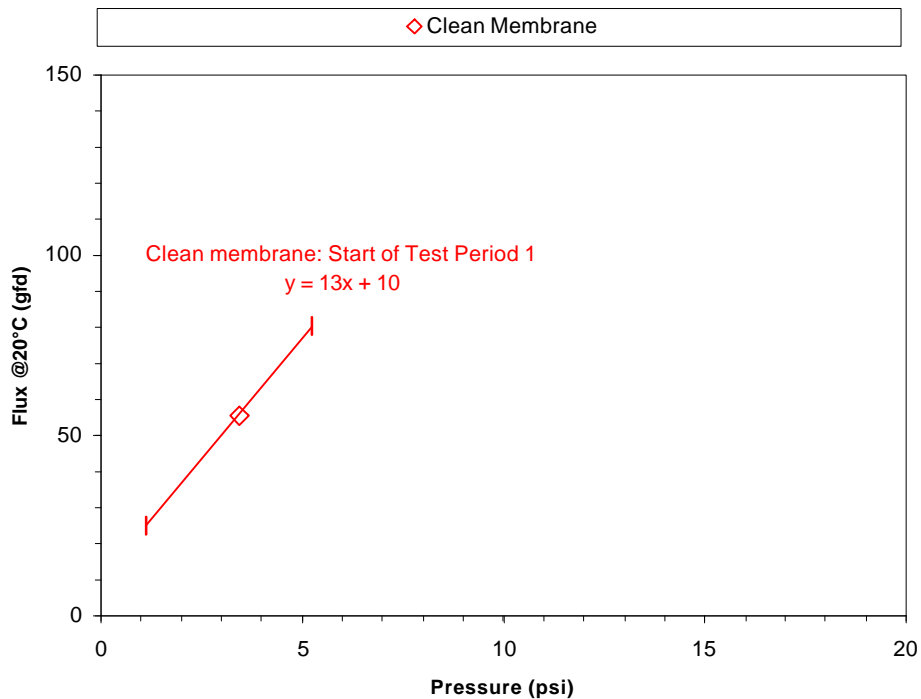

A – Clean membrane: start of Test Period 1.

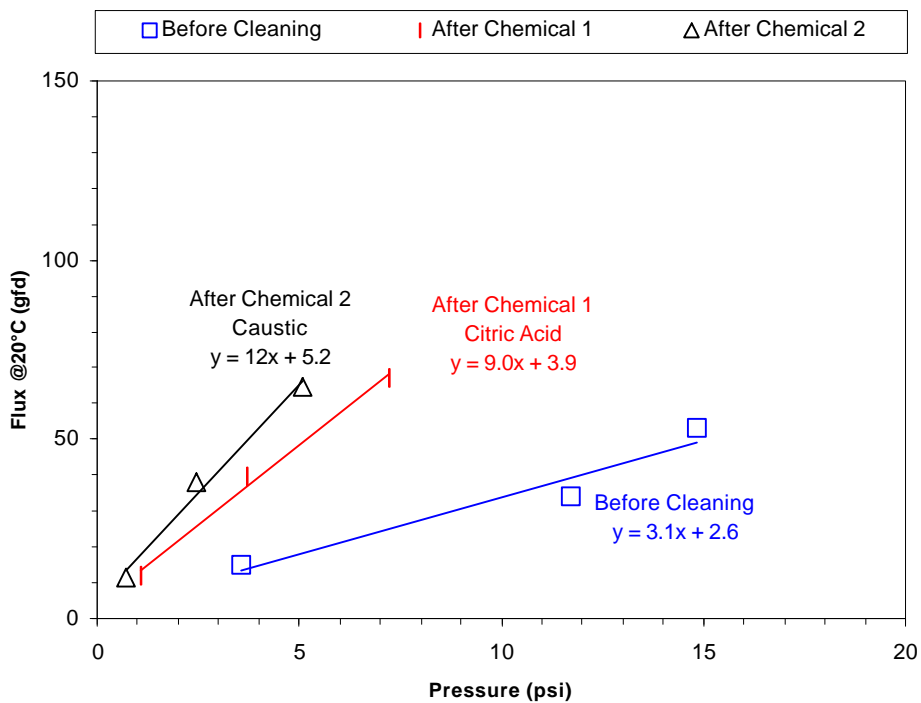

B – Test Period 1: cleaning 1-1 (8/12/99).

Figure 4-3. Clean water flux profile during membrane chemical cleanings – Test Period 1.

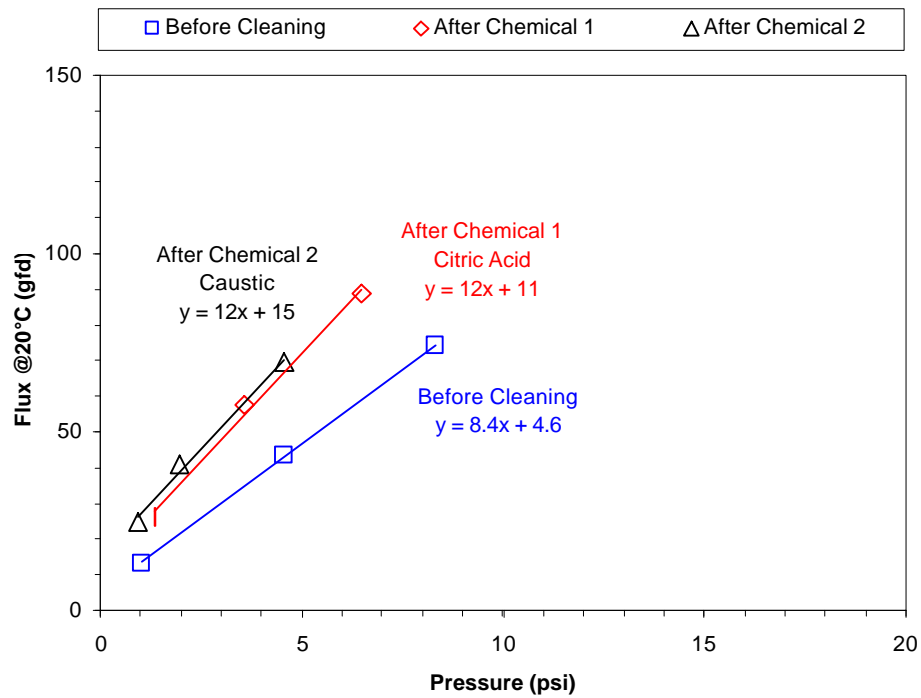

C -Test Period 1: cleaning 1-2 (9/13/99).

Figure 4-3. Continued.

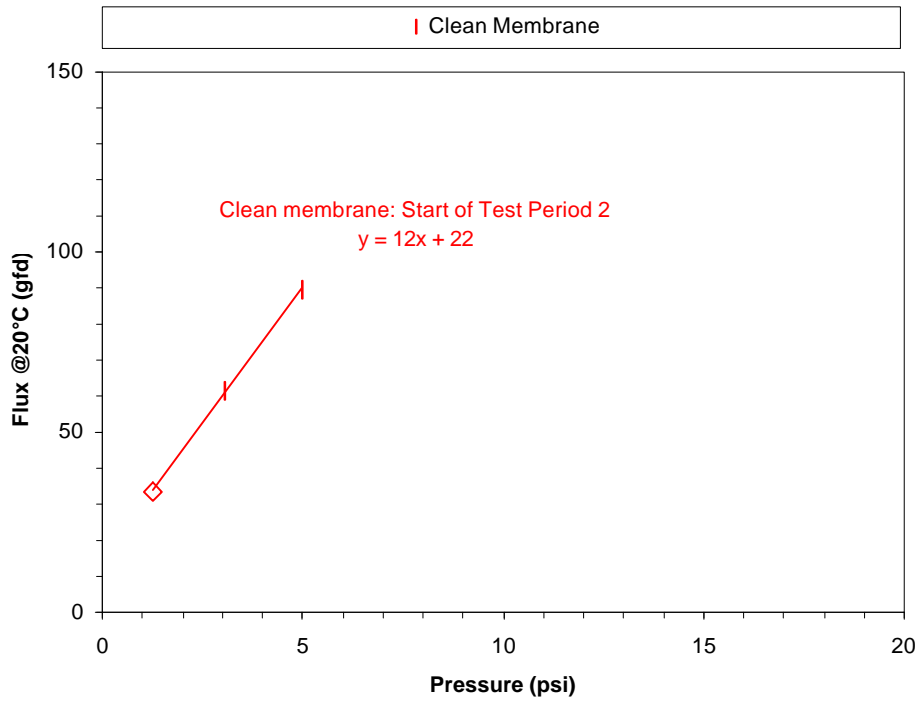

A – Clean membrane: start of Test Period 2.

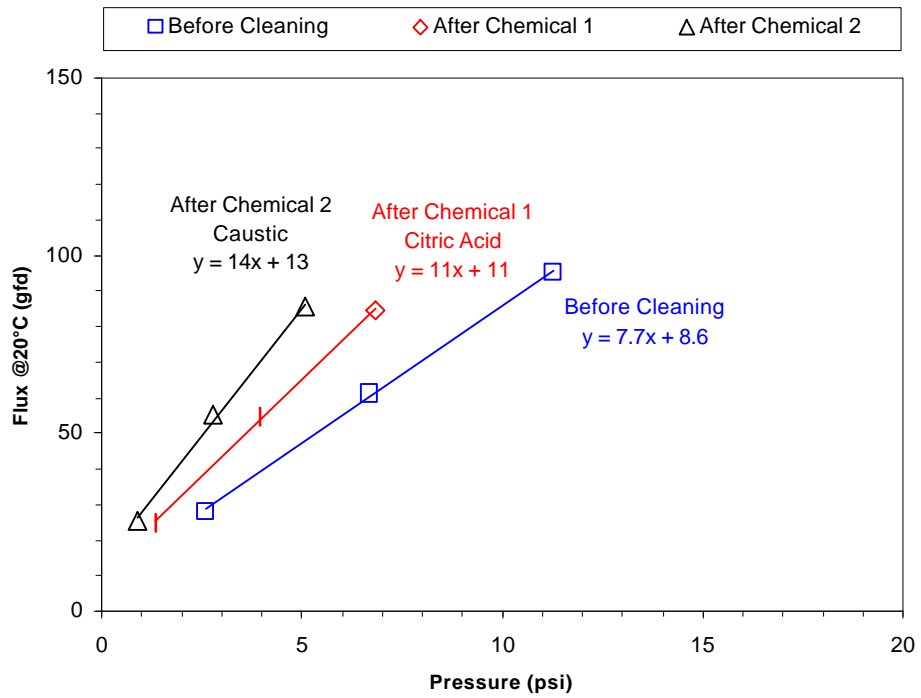

B – Test Period 2: cleaning 2-1 (3/21/00).

Figure 4-4. Clean water flux profile during membrane chemical cleanings – Test Period 2.

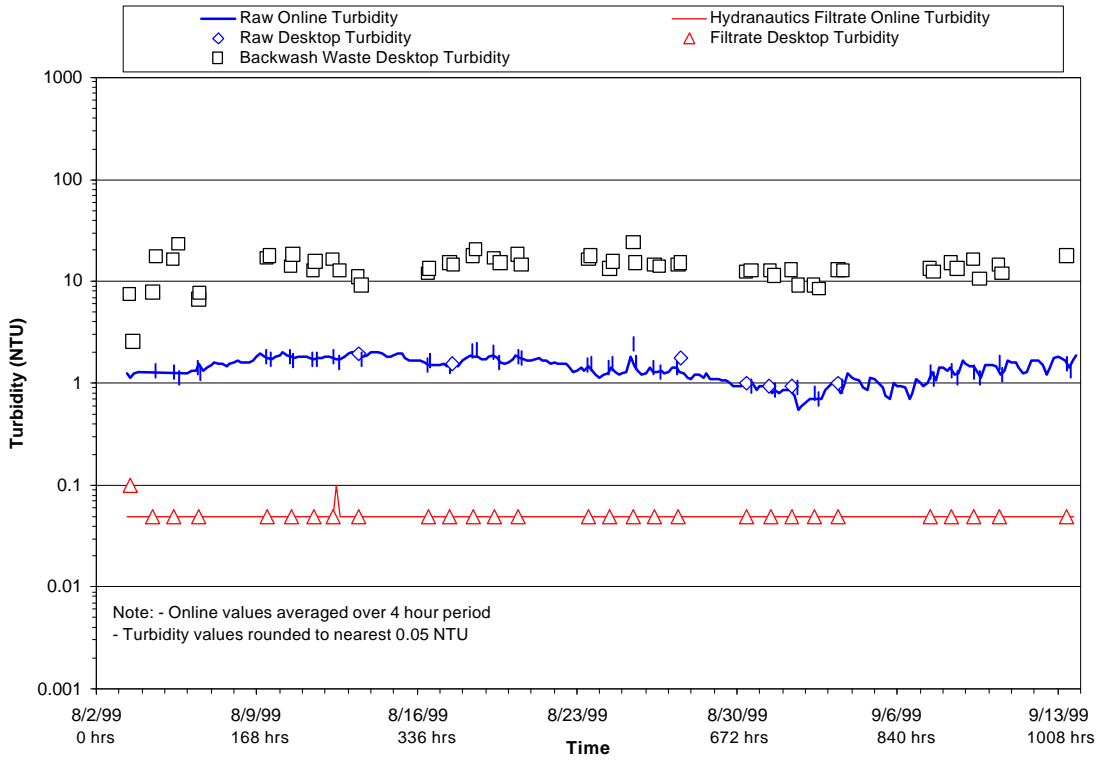

Figure 4-5. Turbidity profile for raw water and Hydranautics UF membrane system – Test Period 1.

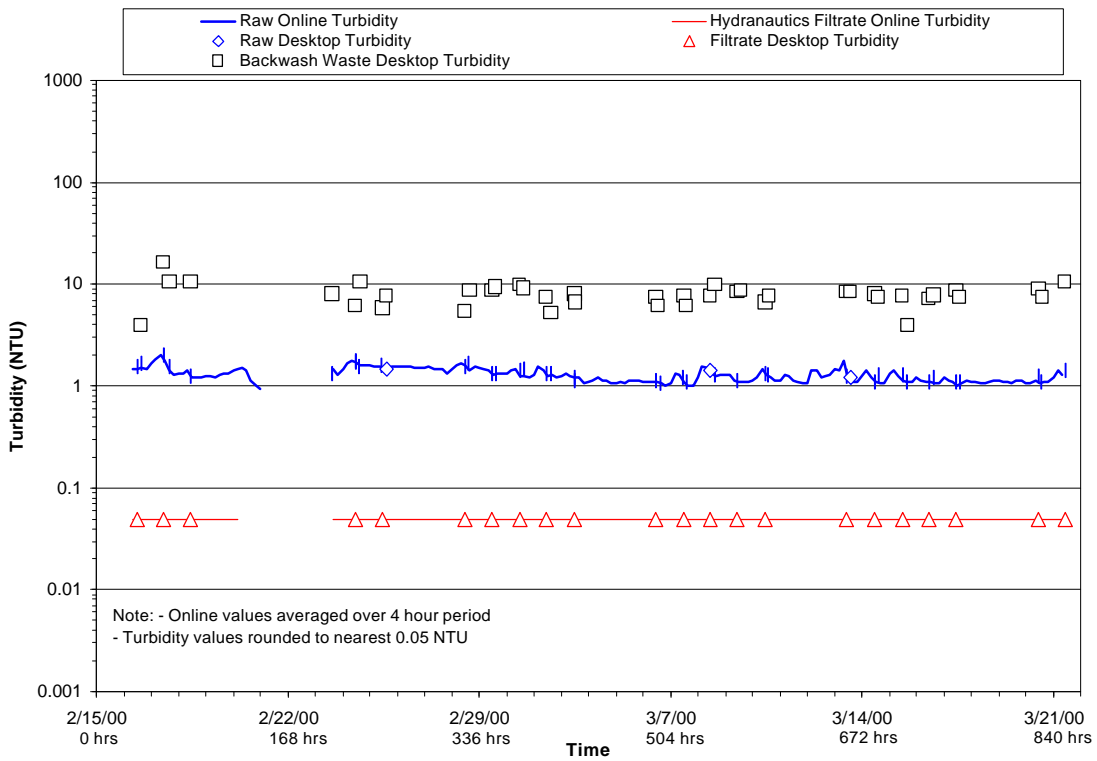
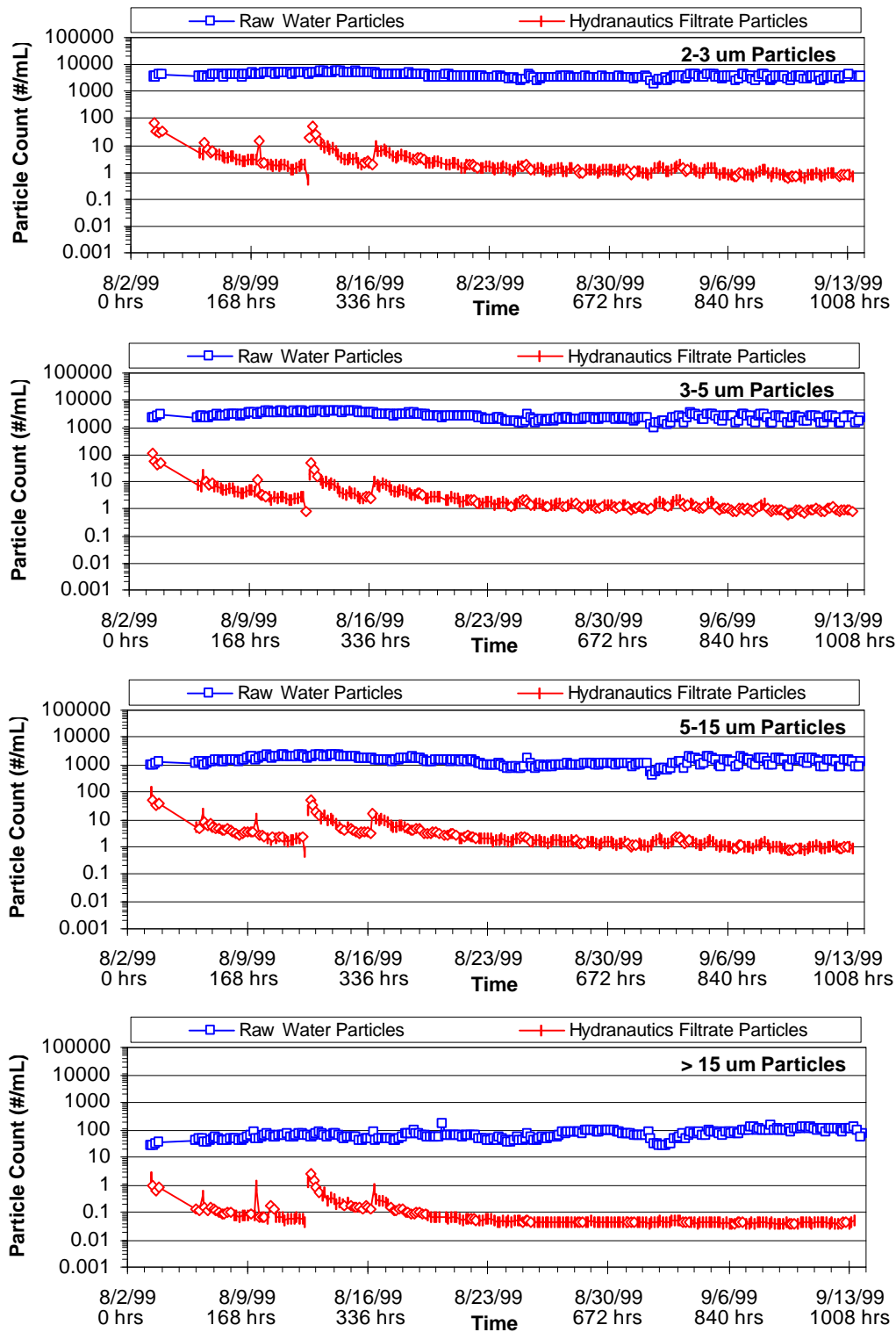
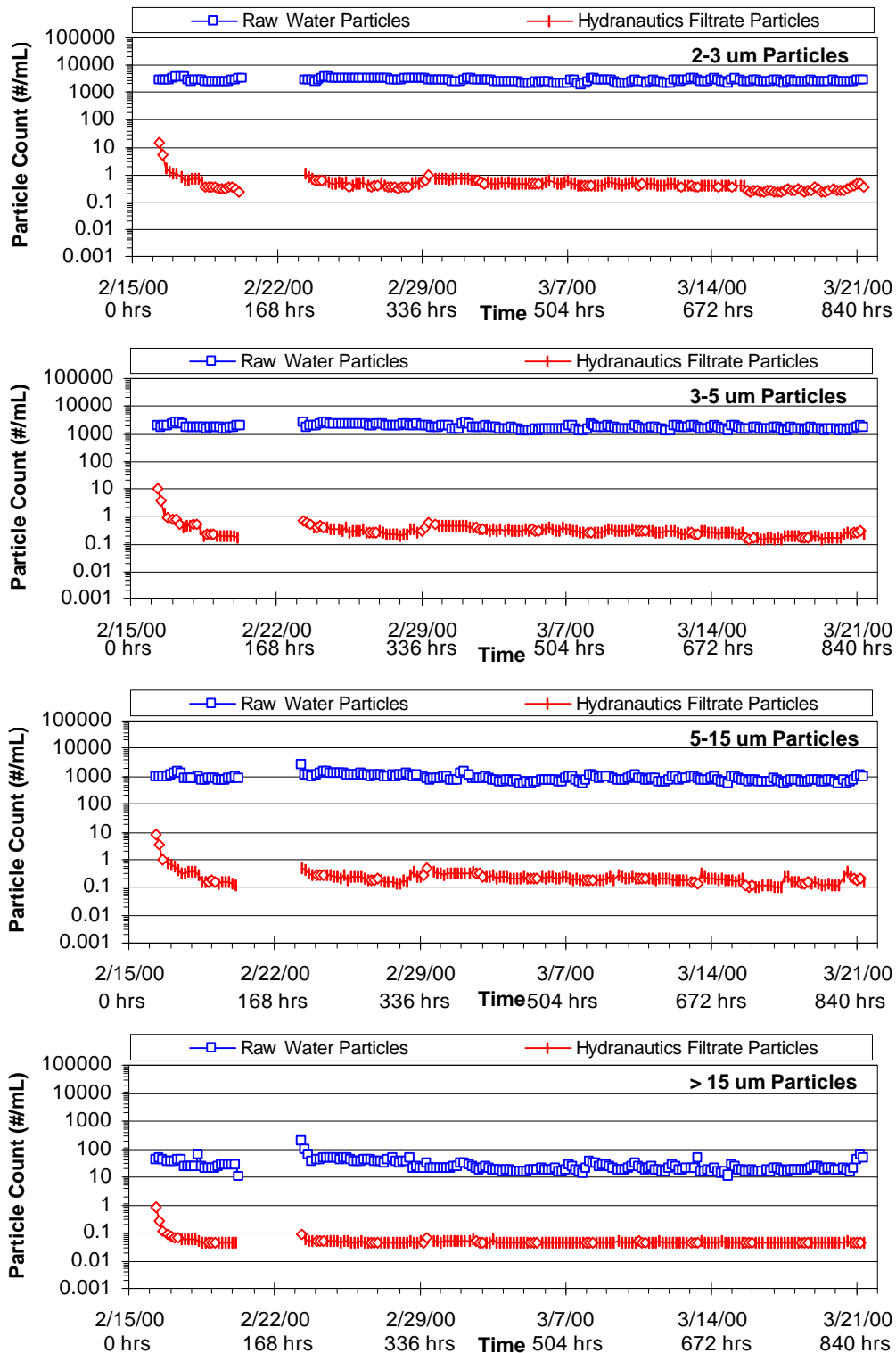

Figure 4-6. Turbidity profile for raw water and Hydranautics UF membrane system – Test Period 2.



Note: On-line values averaged over 4-hour period.

Figure 4-7. Particle count profile for raw water and Hydranautics UF system filtrate – Test Period 1.



Note: On-line values averaged over 4-hour period.  
 Gap in data due to interruption in raw water supply.

Figure 4-8. Particle count profile for raw water and Hydranautics UF system filtrate – Test Period 2.



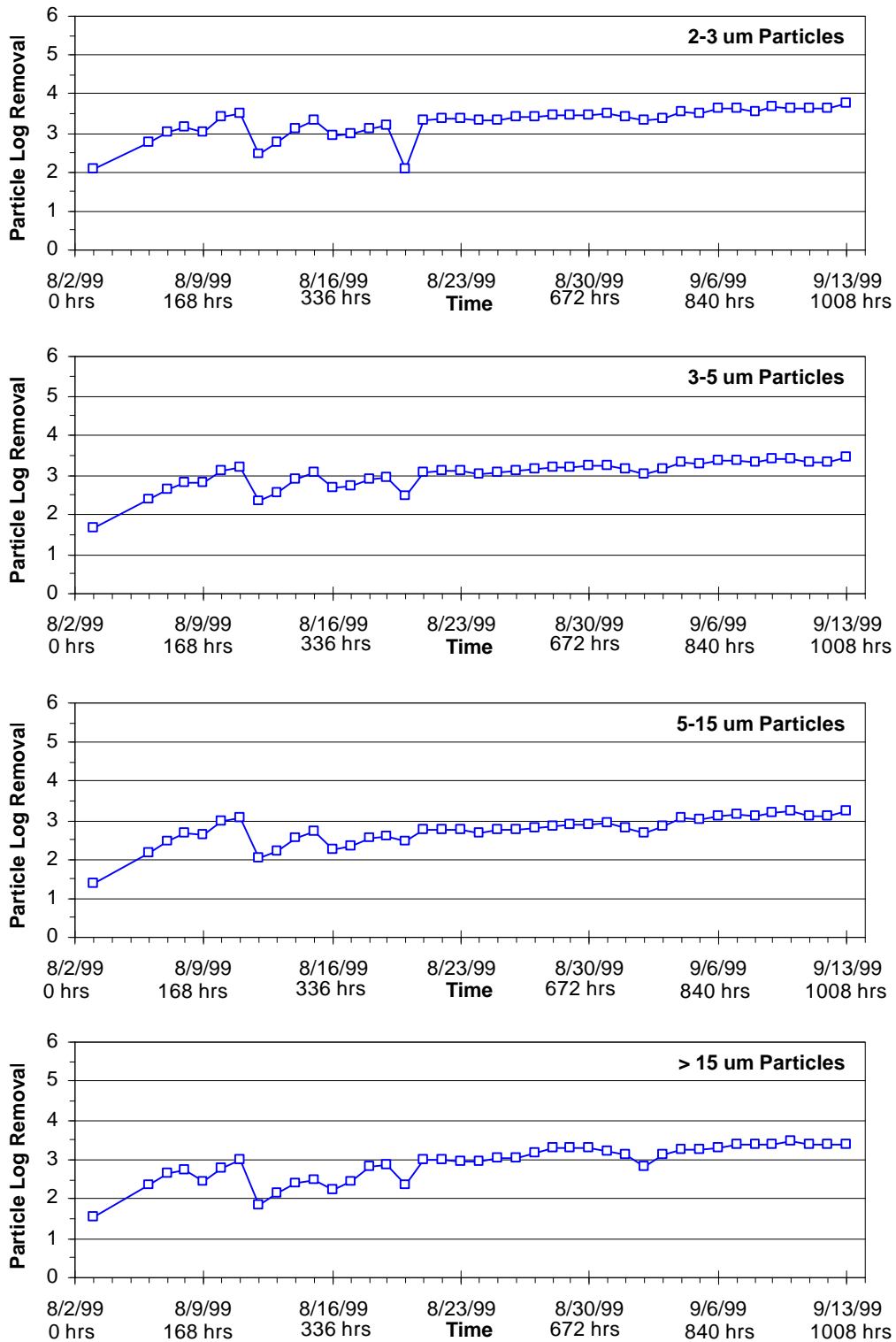

Note: On-line values averaged over 1-day period.

Figure 4-9. Particle removal for the Hydranautics UF system – Test Period 1.

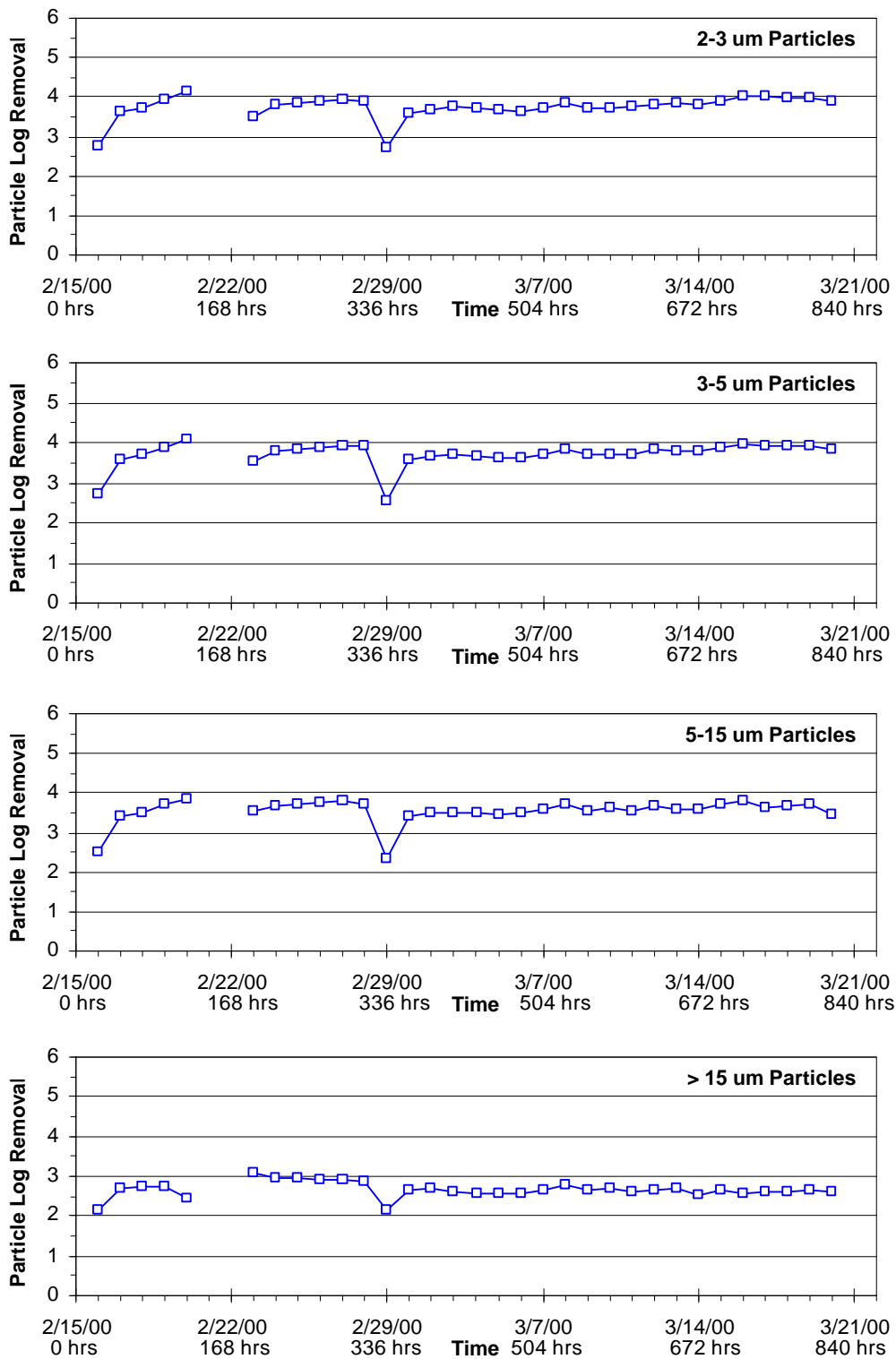

Note: On-line values averaged over 1-day period.  
 Gap in data due to interruption in raw water supply.

Figure 4-10. Particle removal for the Hydranautics UF system – Test Period 2.

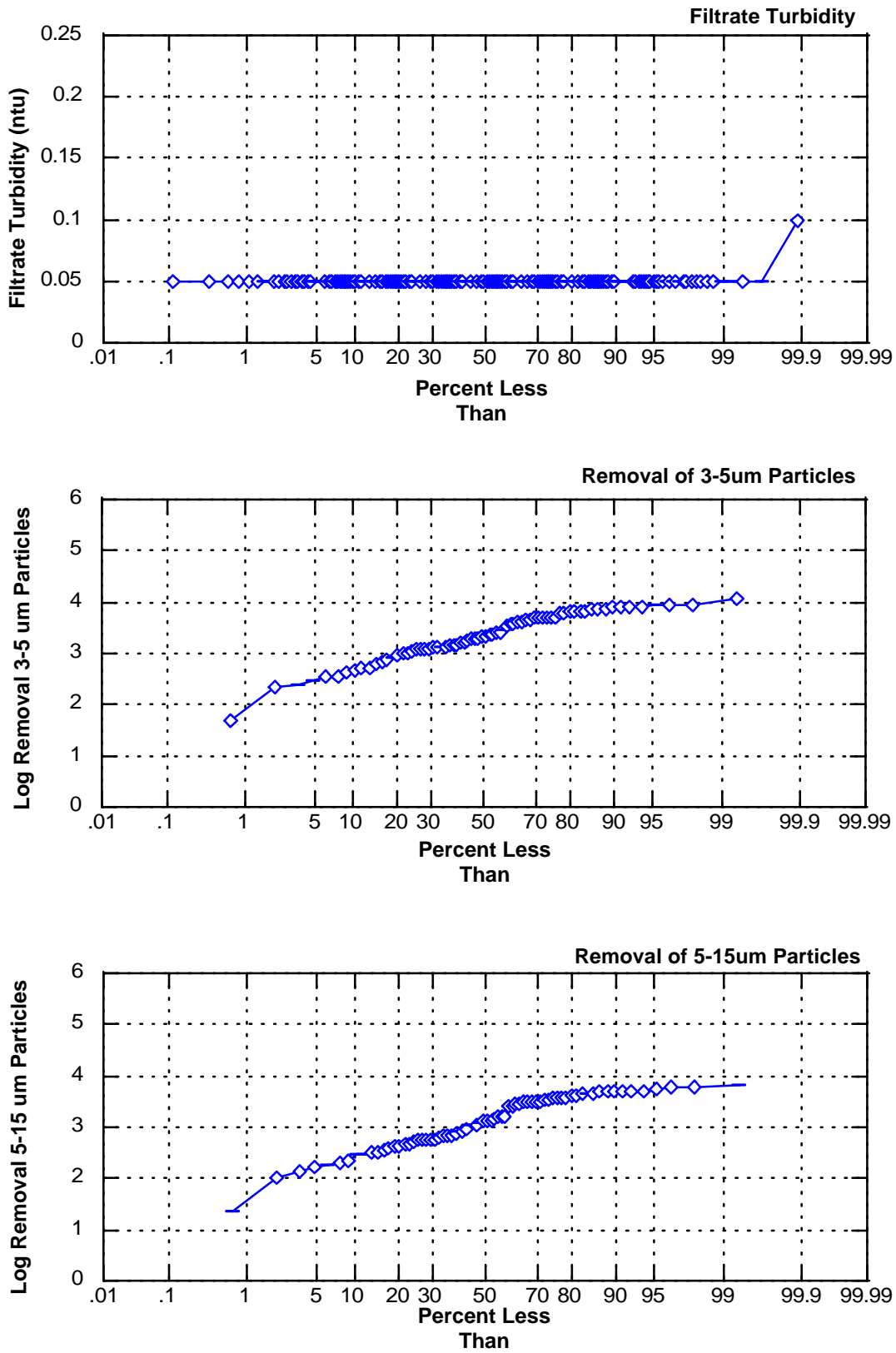
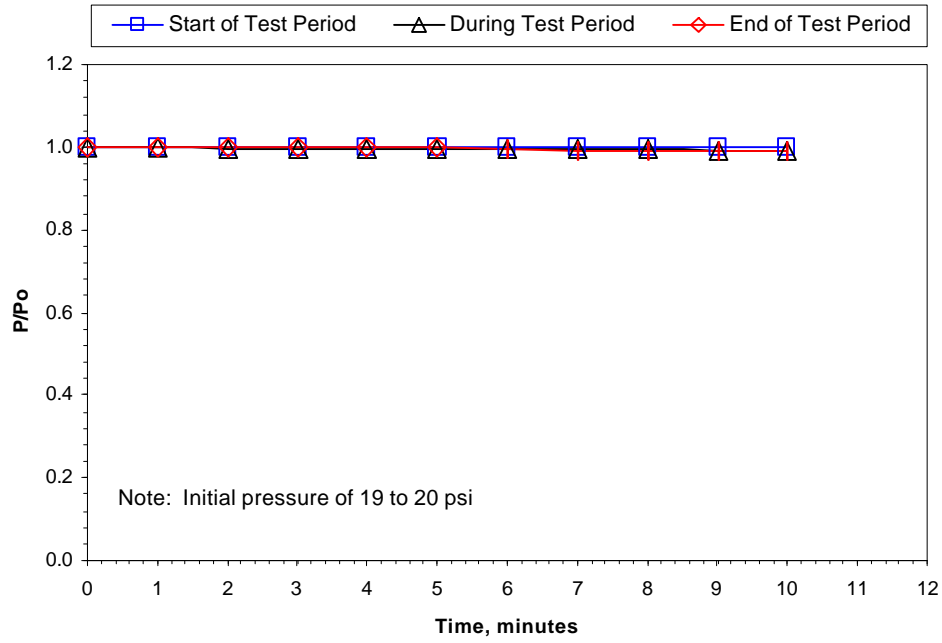
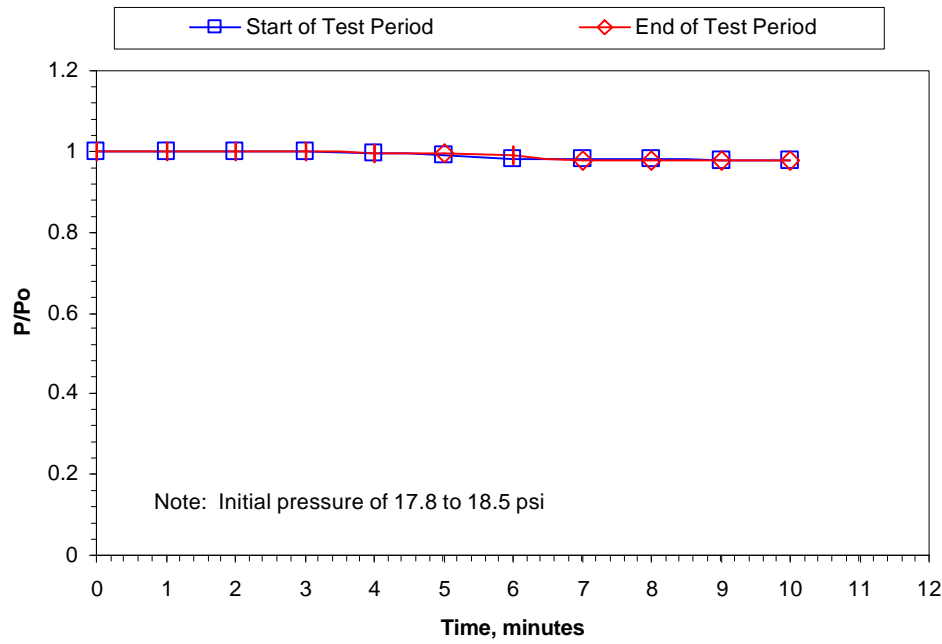

Figure 4-11. Probability plots of filtrate turbidity and log removal of particles for the Hydranautics UF membrane system.



**A – Test Period 1.**



**B – Test Period 2.**

**Figure 4-12. Air pressure hold test results for the Hydranautics UF membrane system.**

Seeding 1  
Date: 8/2/99  
Specific Flux : 15 gfd/psi (360 L/hr-m<sup>2</sup>-bar)

Seeding 2  
Date: 2/16/00  
Specific Flux: 12 gfd/psi (300 L/hr-m<sup>2</sup>-bar)

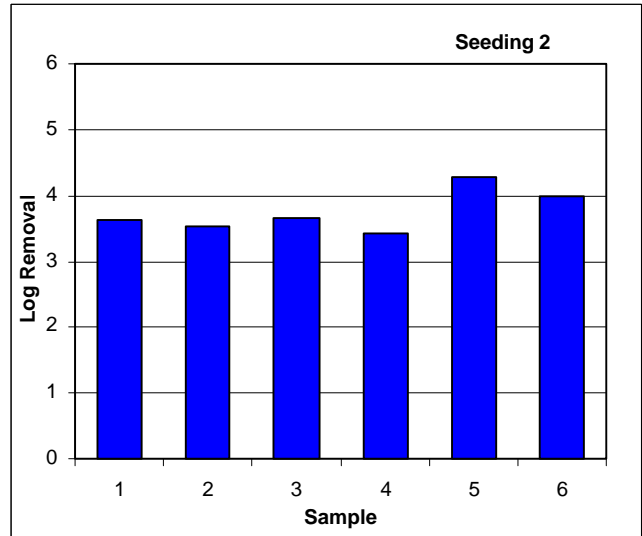
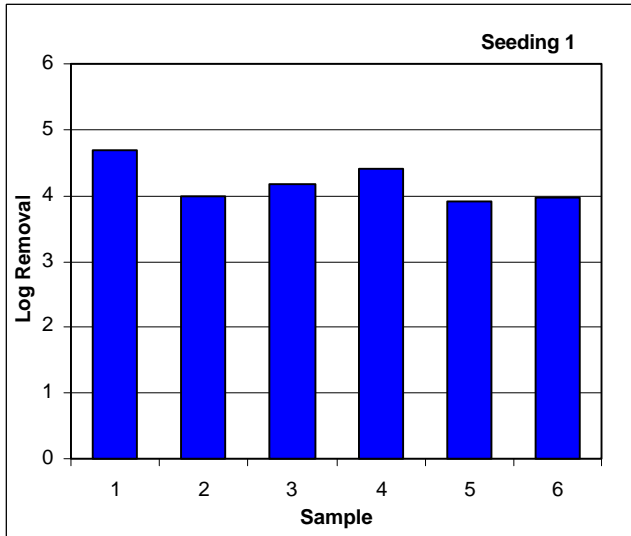

Figure 4-13. Log removal of seeded MS2 virus by Hydranautics UF membrane system.

