

US EPA ARCHIVE DOCUMENT



# Innovative Technology Verification Report

## Sediment Sampling Technology

Art's Manufacturing &  
Supply, Inc.  
Split Core Sampler for  
Submerged Sediments

US EPA ARCHIVE DOCUMENT



# Innovative Technology Verification Report

## Art's Manufacturing & Supply, Inc., Split Core Sampler for Submerged Sediments

Prepared by

Tetra Tech EM Inc.  
Chicago, Illinois

Contract No. 68-C5-0037

Dr. Stephen Billets  
Environmental Sciences Division  
National Exposure Research Laboratory  
Office of Research and Development  
U.S. Environmental Protection Agency  
Las Vegas, Nevada 89193-3478



---

## Notice

This document was prepared for the U.S. Environmental Protection Agency (EPA) Superfund Innovative Technology Evaluation Program under Contract No. 68-C5-0037. The document has been subjected to the EPA's peer and administrative reviews and has been approved for publication. Mention of corporation names, trade names, or commercial products does not constitute endorsement or recommendation of specific products for use.



## ENVIRONMENTAL TECHNOLOGY VERIFICATION PROGRAM VERIFICATION STATEMENT

TECHNOLOGY TYPE:	<b>SEDIMENT SAMPLER</b>
APPLICATION:	<b>CORE SAMPLING OF SEDIMENT</b>
TECHNOLOGY NAME:	<b>ART'S MANUFACTURING &amp; SUPPLY, INC., SPLIT CORE SAMPLER FOR SUBMERGED SEDIMENTS</b>
COMPANY:	<b>ART'S MANUFACTURING &amp; SUPPLY, INC.</b>
ADDRESS:	<b>105 HARRISON AMERICAN FALLS, IDAHO 83211</b>
WEB SITE:	<b><a href="http://www.ams-samplers.com">http://www.ams-samplers.com</a></b>
TELEPHONE:	<b>(208) 226-2017</b>

### VERIFICATION PROGRAM DESCRIPTION

The U.S. Environmental Protection Agency (EPA) created the Superfund Innovative Technology Evaluation (SITE) and Environmental Technology Verification (ETV) Programs to facilitate deployment of innovative technologies through performance verification and information dissemination. The goal of these programs is to further environmental protection by substantially accelerating the acceptance and use of improved and cost-effective technologies. These programs assist and inform those involved in design, distribution, permitting, and purchase of environmental technologies. This document summarizes results of a demonstration of the Split Core Sampler for Submerged Sediments (Split Core Sampler) designed and fabricated by Art's Manufacturing & Supply, Inc.

### PROGRAM OPERATION

Under the SITE and ETV Programs, with the full participation of the technology developers, the EPA evaluates and documents the performance of innovative technologies by developing demonstration plans, conducting field tests, collecting and analyzing demonstration data, and preparing reports. The technologies are evaluated under rigorous quality assurance (QA) protocols to produce well-documented data of known quality. The EPA National Exposure Research Laboratory, which demonstrates field sampling, monitoring, and measurement technologies, selected Tetra Tech EM Inc. as the verification organization to assist in field testing two sediment sampling technologies. This demonstration was funded by the SITE Program.

### DEMONSTRATION DESCRIPTION

In April and May 1999, the EPA conducted a field demonstration of the Split Core Sampler along with one other sediment sampler. This verification statement focuses on the Split Core Sampler; a similar statement has been prepared for the other sampler. The performance and cost of the Split Core Sampler were compared to those of two conventional samplers (the Hand Corer and Vibrocorer), which were used as reference samplers. To verify a wide range of performance attributes, the Split Core Sampler demonstration had both primary and secondary objectives. Primary objectives for this demonstration included evaluating the sampler's ability to (1) consistently collect a given volume of sediment, (2) consistently collect sediment in a given depth interval, (3) collect samples with consistent characteristics from a homogenous layer of sediment, (4) collect a representative sample from a clean sediment layer below a contaminated sediment layer, and (5) be adequately decontaminated. Additional primary objectives were to measure sampling time and estimate sampling costs. Secondary objectives included (1) documenting the skills and training required for sampler operation, (2) evaluating the sampler's ability to collect samples under a variety of site conditions, (3) assessing the sampler's ability to collect an undisturbed sample, (4) evaluating sampler durability, and (5) documenting the availability of the sampler and its spare parts. To ensure data usability, data quality indicators for precision, accuracy, representativeness, completeness, and comparability were also assessed based on project-specific QA objectives.

The Split Core Sampler was demonstrated at sites in EPA Regions 1 and 5. At the Region 1 site, the sampler was demonstrated in a lake and wetland. At the Region 5 site, the sampler was demonstrated in a river mouth and freshwater bay. Collectively, the two sites provided multiple sampling areas with the different water depths, sediment types, sediment contaminant characteristics, and sediment thicknesses necessary to properly evaluate the sampler. Based on the predemonstration investigation results, demonstration objectives, and site support facilities available, (1) the Hand Corer was used as the reference sampler in the lake, wetland, and freshwater bay and (2) the Vibrocorer was used as the reference sampler in the river mouth. A complete description of the demonstration and a summary of its results are available in the "Innovative Technology Verification Report: Sediment Sampling Technology—Art's Manufacturing & Supply, Inc., Split Core Sampler for Submerged Sediments" (EPA/600/R-01/009).

## TECHNOLOGY DESCRIPTION

The Split Core Sampler is an end-filling sampler designed to collect undisturbed core samples of sediment up to a maximum depth of 4 feet below sediment surface (bss). The sampler collects samples from the sediment surface downward, not at discrete depth intervals. Sampler components include one or more split core tubes, couplings for attachment to additional split core tubes, a ball check valve-vented top cap, a coring tip, one or more extension rods, and a cross handle. All these components are made of stainless steel; carbon-steel extension rods are also available from the developer. The sampler may be used with a core tube liner to facilitate removal of an intact sample from the split core tube. To collect a sediment sample, the sampler can be either manually pushed into the sediment using the cross handle or hammered into the sediment using a slide-hammer or an electric hammer. The check valve in the sampler's top cap allows water to exit the sampler during deployment and creates a vacuum to help retain a sediment core during sampler retrieval. The sampler can be retrieved by hand, by reverse hammering using the slide-hammer, or by using a tripod-mounted winch.

## VERIFICATION OF PERFORMANCE

Key demonstration findings are summarized below for the primary objectives.

***Consistently Collecting a Given Volume of Sediment:*** In the shallow depth interval (0 to 4 inches bss), to collect a specified number of samples, the Split Core Sampler required 7 percent more attempts than expected (46 actual versus 43 expected), whereas the reference samplers required 14 percent more attempts than expected (49 actual versus 43 expected). In the moderate depth interval (4 to 32 inches bss), the Split Core Sampler required 38 percent more attempts than expected (40 actual versus 29 expected), but the reference samplers required 156 percent more attempts than expected (64 actual versus 25 expected).

For the shallow depth interval, mean sample recoveries ranging from 89 to 100 percent were achieved by the Split Core Sampler, whereas mean sample recoveries for the reference samplers ranged from 85 to 100 percent. The variation in sample recoveries as measured by their relative standard deviations (RSD) ranged from 0 to 26 percent for the Split Core Sampler, whereas the reference samplers' RSDs ranged from 0 to 33 percent. For the moderate depth interval, mean sample recoveries ranging from 37 to 100 percent were achieved by the Split Core Sampler, whereas the reference samplers' mean sample recoveries ranged from 21 to 82 percent. The RSDs for the Split Core Sampler ranged from 0 to 51 percent, whereas the reference samplers' RSDs ranged from 3 to 161 percent.

***Consistently Collecting Sediment in a Given Depth Interval:*** Both the Split Core Sampler and reference samplers collected samples in shallow and moderate depth intervals in all demonstration areas, which contained various sediment types. No sampler was able to collect samples in the deep depth interval (4 to 11 feet bss). For the shallow depth interval, the Split Core Sampler's actual core lengths equaled the target core length in 96 percent of the total sampling attempts. The reference samplers' actual core lengths equaled the target core length in 94 percent of the total sampling attempts. For the moderate depth interval, the Split Core Sampler's actual core lengths equaled the target core length in 39 percent of the total sampling attempts. The reference samplers' actual core lengths equaled the target core length in 13 percent of the total sampling attempts.

***Collecting Samples with Consistent Characteristics from a Homogenous Layer of Sediment:*** Based on particle size distribution results, both the Split Core Sampler and reference samplers collected samples with consistent physical characteristics from two homogenous layers of sediment (a sandy silt layer and a clayey silt layer).

***Collecting a Representative Sample from a Clean Sediment Layer Below a Contaminated Sediment Layer:*** In sampling a clean sediment layer below a contaminated sediment layer, the Split Core Sampler and reference sampler (the Hand Corer) collected samples whose contaminant concentrations were statistically different at a significance level of 0.05. Arsenic concentrations in the samples collected by the Split Core Sampler were less than those in the samples collected by the Hand Corer. However, because of the greater opportunity for sample compaction in the Split Core Sampler, no conclusion could be drawn regarding this sampler's ability to collect representative samples from a clean layer below a contaminated layer.

**Sampler Decontamination:** Both the Split Core Sampler and reference samplers demonstrated the ability to be adequately decontaminated after sampling in areas contaminated with either polychlorinated biphenyls or arsenic.

**Sampling Time:** Compared to the reference samplers, the Split Core Sampler reduced sampling time by 15 to 52 percent in three of the four areas sampled but increased the sampling time by 8 percent in the remaining area.

**Sampling Costs:** Of the sampling costs estimated for two of the four areas sampled, in one area the sampling costs for the Split Core Sampler were 95 percent less than those for the reference sampler (the Vibrocorer), and in the other area the sampling costs for the Split Core Sampler were 8 percent more than those for the reference sampler (the Hand Corer).

Key demonstration findings are summarized below for the secondary objectives.

**Skill and Training Requirements:** The Split Core Sampler, like the Hand Corer, is easy to operate and requires minimal skills and training. However, operation of the Vibrocorer is relatively complicated and requires moderate skills and training. The Split Core Sampler was operated by one person, whereas the Hand Corer was operated by one or two persons and the Vibrocorer was operated by two persons. When more than two extension rods were required, the Split Core Sampler and Hand Corer were operated using a tripod-mounted winch. The Vibrocorer operation required a motor-operated winch because of the weight of the sampler.

**Sampling Under a Variety of Site Conditions:** Both the Split Core Sampler and reference samplers collected samples in shallow and moderate depth intervals in all demonstration areas, which contained various sediment types. No sampler was able to collect samples in the deep depth interval (4 to 11 feet bss). For more efficient recovery of samples, an electric hammer should be used to induce vibrations in the Split Core Sampler; a 110-volt power supply is required to operate the electric hammer. The Vibrocorer requires a three-phase, 230- or 440-volt, 50- to 60-hertz power supply, which is a sampler limitation if the power supply fails. The Hand Corer does not require a power supply.

**Collecting an Undisturbed Sample:** Based on visual observations, both the Split Core Sampler and reference samplers collected partially compressed core samples of consolidated and unconsolidated sediments from the sediment surface downward. Samples collected by both the Split Core Sampler and reference samplers in moderate and deep depth intervals may be of questionable representativeness because of core shortening and core compression. Sediment stratification was preserved for both consolidated and unconsolidated sediments in the samples collected by the Split Core Sampler and reference samplers.

**Sampler Durability and Availability:** Based on their materials of construction and engineering designs, both the Split Core Sampler and reference samplers are considered to be sturdy. The Split Core Sampler and its support equipment are not expected to be available in local retail stores. Similarly, the primary components of the Hand Corer and Vibrocorer are not expected to be available in local retail stores; extension rods for the Hand Corer may be locally available.

Based on the demonstration results, the Split Core Sampler can be operated by one person with minimal skills and training. For more efficient recovery of samples, an electric hammer should be used to induce vibrations in the sampler. When more than two extension rods are used, a winch is recommended for sampler operation. The sampler is designed to collect sediment samples up to a maximum depth of 4 feet bss and, based on visual observations, collects partially compressed samples of both consolidated and unconsolidated sediments from the sediment surface downward; sample representativeness may be questionable because of core shortening and core compression. The sampler preserves sediment stratification in both consolidated and unconsolidated sediment samples. The Split Core Sampler is a good alternative to conventional sediment samplers. As with any sampler selection, the user must determine the appropriate sampler for a given application based on project-specific data quality objectives.

Gary J. Foley, Ph.D.  
Director  
National Exposure Research Laboratory  
Office of Research and Development

**NOTICE:** EPA verifications are based on an evaluation of technology performance under specific, predetermined criteria and appropriate quality assurance procedures. The EPA makes no expressed or implied warranties as to the performance of the technology and does not certify that a technology will always operate as verified. The end user is solely responsible for complying with any and all applicable federal, state, and local requirements.

---

## Foreword

The U.S. Environmental Protection Agency (EPA) is charged by Congress with protecting the nation's natural resources. Under the mandate of national environmental laws, the agency strives to formulate and implement actions leading to a compatible balance between human activities and the ability of natural systems to support and nurture life. To meet this mandate, the EPA Office of Research and Development provides data and scientific support that can be used to solve environmental problems, build the scientific knowledge base needed to manage ecological resources wisely, understand how pollutants affect public health, and prevent or reduce environmental risks.

The National Exposure Research Laboratory (NERL) is the agency's center for investigation of technical and management approaches for identifying and quantifying risks to human health and the environment. Goals of the laboratory's research program are to (1) develop and evaluate methods and technologies for characterizing and monitoring air, soil, and water; (2) support regulatory and policy decisions; and (3) provide the scientific support needed to ensure effective implementation of environmental regulations and strategies.

The EPA Superfund Innovative Technology Evaluation (SITE) Program evaluates technologies designed for characterization and remediation of contaminated Superfund and Resource Conservation and Recovery Act sites. The SITE Program was created to provide reliable cost and performance data in order to speed acceptance and use of innovative remediation, characterization, and monitoring technologies by the regulatory and user community.

Effective measurement and monitoring technologies are needed to assess the degree of contamination at a site, provide data that can be used to determine the risk to public health or the environment, supply the necessary cost and performance data to select the most appropriate technology, and monitor the success or failure of a remediation process. One component of the EPA SITE Program, the Monitoring and Measurement Technology (MMT) Program, demonstrates and evaluates innovative technologies to meet these needs.

Candidate technologies can originate within the federal government or the private sector. Through the SITE Program, developers are given the opportunity to conduct a rigorous demonstration of their technologies under actual field conditions. By completing the demonstration and distributing the results, the agency establishes a baseline for acceptance and use of these technologies. The MMT Program is administered by the Environmental Sciences Division of NERL in Las Vegas, Nevada.

Gary J. Foley, Ph.D.  
Director  
National Exposure Research Laboratory  
Office of Research and Development



---

## Abstract

The Split Core Sampler for Submerged Sediments (Split Core Sampler) designed and fabricated by Art's Manufacturing & Supply, Inc., was demonstrated under the U.S. Environmental Protection Agency (EPA) Superfund Innovative Technology Evaluation Program in April and May 1999 at sites in EPA Regions 1 and 5, respectively. In addition to assessing ease of sampler operation, key objectives of the demonstration included evaluating the sampler's ability to (1) consistently collect a given volume of sediment, (2) consistently collect sediment in a given depth interval, (3) collect samples with consistent characteristics from a homogenous layer of sediment, and (4) collect samples under a variety of site conditions. This report describes the demonstration results for the Split Core Sampler and two conventional samplers (the Hand Corer and Vibrocorer) used as reference samplers. During the demonstration, the Split Core Sampler performed as well as or better than the reference samplers. Based on visual observations, both the Split Core Sampler and reference samplers collected partially compressed samples of consolidated and unconsolidated sediments from the sediment surface downward; sample representativeness may be questionable because of core shortening and core compression. Sediment stratification was preserved for both consolidated and unconsolidated sediment samples collected by the Split Core Sampler and reference samplers. No sampler was able to collect samples in the deep depth interval (4 to 11 feet below sediment surface). The average sampling time was less for the Split Core Sampler than for the reference samplers. Sampling costs for the Split Core Sampler were 8 percent greater than those for the Hand Corer and 95 percent less than those for the Vibrocorer.

## Contents

<u>Chapter</u>	<u>Page</u>
Notice .....	ii
Verification Statement .....	iii
Foreword .....	vi
Abstract .....	vii
Figures .....	xiii
Tables .....	xv
Abbreviations, Acronyms, and Symbols .....	xvii
Acknowledgments .....	xix
1 Introduction .....	1
1.1 Description of the SITE Program .....	1
1.2 Scope of the Demonstration .....	4
2 Description of the Innovative Sediment Sampler .....	6
2.1 Sampler Description .....	6
2.2 General Operating Procedures .....	8
2.3 Advantages and Limitations .....	8
2.4 Developer Contact Information .....	9
3 Demonstration Site Descriptions .....	10
3.1 EPA Region 5 Site (Site 1) .....	10
3.1.1 Site 1, Area 1 .....	10
3.1.2 Site 1, Area 2 .....	11
3.2 EPA Region 1 Site (Site 2) .....	12
3.2.1 Site 2, Area 1 .....	12
3.2.2 Site 2, Area 2 .....	12
4 Demonstration Approach .....	13
4.1 Demonstration Objectives .....	13

---

## Contents (Continued)

<u>Chapter</u>		<u>Page</u>
4.2	Demonstration Design .....	14
4.3	Field Sampling and Measurement Procedures .....	17
4.4	Laboratory Sample Preparation and Analysis Methods .....	22
5	Description of the Reference Sediment Samplers .....	26
5.1	Hand Corer .....	26
5.1.1	Technology Description .....	26
5.1.2	General Operating Procedures .....	27
5.1.3	Advantages and Limitations .....	28
5.2	Vibrocorer .....	28
5.2.1	Technology Description .....	28
5.2.2	General Operating Procedures .....	29
5.2.3	Advantages and Limitations .....	30
6	Performance of the Split Core Sampler .....	31
6.1	Primary Objectives .....	31
6.1.1	Ability to Consistently Collect a Specified Volume of Sediment ....	32
6.1.1.1	Number of Sampling Attempts Required .....	32
6.1.1.2	Volume of Sediment Collected .....	34
6.1.2	Ability to Consistently Collect Sediment in a Specified Depth Interval .....	37
6.1.3	Ability to Collect Multiple Samples with Consistent Physical or Chemical Characteristics, or Both, from a Homogenous Layer of Sediment .....	39
6.1.4	Ability to Collect a Representative Sample from a Clean Sediment Layer Below a Contaminated Sediment Layer .....	42
6.1.5	Ability to be Adequately Decontaminated .....	44
6.1.6	Time Requirements for Sample Collection Activities .....	44
6.2	Secondary Objectives .....	46
6.2.1	Skill and Training Requirements for Proper Sampler Operation ....	46
6.2.2	Ability to Collect Samples Under a Variety of Site Conditions .....	47
6.2.3	Ability to Collect an Undisturbed Sample .....	48
6.2.4	Durability Based on Materials of Construction and Engineering Design .....	48
6.2.5	Availability of Sampler and Spare Parts .....	48
6.3	Data Quality .....	48
6.3.1	Field Measurement Activities .....	49
6.3.2	Laboratory Analysis Activities .....	49
7	Performance of the Reference Samplers .....	53
7.1	Primary Objectives .....	53
7.1.1	Ability to Consistently Collect a Specified Volume of Sediment ....	54
7.1.1.1	Number of Sampling Attempts Required .....	54

---

## Contents (Continued)

<u>Chapter</u>		<u>Page</u>
	7.1.1.2 Volume of Sediment Collected . . . . .	56
7.1.2	Ability to Consistently Collect Sediment in a Specified Depth Interval . . . . .	58
7.1.3	Ability to Collect Multiple Samples with Consistent Physical or Chemical Characteristics, or Both, from a Homogenous Layer of Sediment . . . . .	60
7.1.4	Ability to be Adequately Decontaminated . . . . .	63
7.1.5	Time Requirements for Sample Collection Activities . . . . .	64
7.2	Secondary Objectives . . . . .	65
7.2.1	Skill and Training Requirements for Proper Sampler Operation . . . . .	65
7.2.2	Ability to Collect Samples Under a Variety of Site Conditions . . . . .	66
7.2.3	Ability to Collect an Undisturbed Sample . . . . .	67
7.2.4	Durability Based on Materials of Construction and Engineering Design . . . . .	67
7.2.5	Availability of Sampler and Spare Parts . . . . .	67
7.3	Data Quality . . . . .	68
7.3.1	Field Measurement Activities . . . . .	68
7.3.2	Laboratory Analysis Activities . . . . .	69
8	Economic Analysis . . . . .	71
8.1	Issues and Assumptions . . . . .	71
8.1.1	Sampler Costs . . . . .	71
8.1.2	Labor Costs . . . . .	71
8.1.3	IDW Disposal Costs . . . . .	72
8.1.4	Support Equipment Costs . . . . .	72
8.1.5	Costs Not Included . . . . .	73
8.2	Split Core Sampler Costs . . . . .	74
8.2.1	Sampler Cost . . . . .	74
8.2.2	Labor Cost . . . . .	74
8.2.3	IDW Disposal Cost . . . . .	74
8.2.4	Support Equipment Cost . . . . .	74
8.2.5	Summary of Split Core Sampler Costs . . . . .	76
8.3	Hand Corer Costs . . . . .	76
8.3.1	Sampler Cost . . . . .	76
8.3.2	Labor Cost . . . . .	76
8.3.3	IDW Disposal Cost . . . . .	76
8.3.4	Support Equipment Cost . . . . .	77
8.3.5	Summary of Hand Corer Costs . . . . .	77
8.4	Vibrocorer Costs . . . . .	77
8.4.1	Sampler Cost . . . . .	77
8.4.2	Labor Cost . . . . .	77
8.4.3	IDW Disposal Cost . . . . .	77
8.4.4	Support Equipment Cost . . . . .	78

---

## Contents (Continued)

<u>Chapter</u>		<u>Page</u>
	8.4.5 Summary of Vibrocorer Costs .....	78
8.5	Comparison of Economic Analysis Results .....	78
9	Summary of Demonstration Results .....	79
9.1	Primary Objectives .....	79
9.2	Secondary Objectives .....	84
10	References .....	86
Appendix A	Developer's Claims for the AMS Split Core Sampler for Submerged Sediments .....	88
A.1	Updates or Improvements to the Split Core Sampler .....	88
A.2	Prior Deployment of the Split Core Sampler .....	89
A.3	Developer Comments on the SITE Demonstration .....	89
Appendix B	Performance and Cost of the Ekman Grab .....	90
B.1	Description of the Ekman Grab .....	90
B.1.1	Sampler Description .....	90
B.1.2	General Operating Procedures .....	91
B.1.3	Advantages and Limitations .....	91
B.2	Description of the Demonstration Sites .....	92
B.3	Demonstration Approach .....	92
B.3.1	Demonstration Objectives .....	92
B.3.2	Demonstration Design .....	93
B.3.3	Field Sampling and Measurement Procedures .....	94
B.4	Performance of the Ekman Grab .....	96
B.4.1	Primary Objectives .....	96
B.4.1.1	Ability to Consistently Collect a Specified Volume of Sediment .....	97
B.4.1.2	Ability to Consistently Collect Sediment in a Specified Depth Interval .....	99
B.4.1.3	Ability to Collect Multiple Samples with Consistent Physical or Chemical Characteristics, or Both, from a Homogenous Layer of Sediment .....	100
B.4.1.4	Ability to be Adequately Decontaminated .....	101
B.4.1.5	Time Requirements for Sample Collection Activities .....	101
B.4.1.6	Costs Associated with Sample Collection Activities .....	103
B.4.2	Secondary Objectives .....	105
B.4.2.1	Skill and Training Requirements for Proper Sampler Operation .....	105
B.4.2.2	Ability to Collect Samples Under a Variety of Site Conditions .....	105
B.4.2.3	Ability to Collect an Undisturbed Sample .....	106

---

## Contents (Continued)

<u>Chapter</u>		<u>Page</u>
	B.4.2.4 Durability Based on Materials of Construction and Engineering Design .....	107
	B.4.2.5 Availability of Sampler and Spare Parts .....	107
B.4.3	Data Quality .....	107
	B.4.3.1 Field Measurement Activities .....	107
	B.4.3.2 Laboratory Analysis Activities .....	108
B.5	References .....	108
Appendix C	Statistical Methods .....	109
C.1	Wilk-Shapiro Test .....	109
C.2	Wilcoxon Signed Rank Test .....	110
C.3	References .....	113

**Figures**

<b><u>Figure</u></b>	<b><u>Page</u></b>
2-1. Split Core Sampler .....	7
4-1. Site 1 sampling locations .....	18
4-2. Site 2 sampling locations .....	19
5-1. Hand Corer .....	27
5-2. Vibrocorer .....	29
6-1. Percent sample recoveries for Split Core Sampler at Site 1 .....	35
6-2. Percent sample recoveries for Split Core Sampler at Site 2 .....	36
6-3. Split Core Sampler sample particle size distribution results for S1A2 (freshwater bay) .....	40
6-4. Split Core Sampler sample arsenic and particle size distribution results for S2A1 (lake) .....	41
6-5. Comparison of Split Core Sampler and reference sampler arsenic concentration results for S2A1 (lake) .....	43
7-1. Percent sample recoveries for Vibrocorer and Hand Corer at Site 1 .....	56
7-2. Percent sample recoveries for Hand Corer at Site 2 .....	57
7-3. Hand Corer sample particle size distribution results for S1A2 (freshwater bay) .....	61
7-4. Hand Corer sample arsenic and particle size distribution results for S2A1 (lake) .....	62
B-1. Ekman Grab .....	91
B-2. Sampling locations for Ekman Grab demonstration .....	95
B-3. Percent sample recoveries for Ekman Grab in S1A1 (river mouth), S1A2 (freshwater bay), and S2A1 (lake) .....	100
B-4. Ekman Grab sample analytical results for S1A1 (river mouth) and S2A1 (lake) .....	102
C-1. Wilk-Shapiro test plot for core length measurements in S1A2 (freshwater bay) .....	110
C-2. Wilk-Shapiro test plot for core length measurements in S2A2 (wetland) .....	111
C-3. Statistix <sup>®</sup> output for Hand Corer sample data for S2A2 (wetland) .....	112

---

## Figures (Continued)

<u>Figure</u>	<u>Page</u>
C-4. Statistix <sup>®</sup> output for Hand Corer and Split Core Sampler sample data for S2A1 (lake) .....	112



**Tables**

<u>Table</u>	<u>Page</u>
3-1. Demonstration Area Characteristics .....	11
4-1. Innovative Sediment Sampler Demonstration Design .....	15
4-2. Rationale for Sampling Approach .....	20
4-3. Sample Matrix .....	23
4-4. Laboratory Sample Preparation and Analysis Methods .....	24
4-5. Laboratory Quality Control Checks .....	25
6-1. Comparison of Expected and Actual Number of Sampling Attempts for Split Core Sampler at Site 1 .....	33
6-2. Comparison of Expected and Actual Number of Sampling Attempts for Split Core Sampler at Site 2 .....	34
6-3. Percent Sample Recovery Summary Statistics for Split Core Sampler .....	37
6-4. Comparison of Target and Actual Core Length Data for Split Core Sampler .....	38
6-5. Particle Size Distribution Summary Statistics for Split Core Sampler .....	42
6-6. Time Required to Complete Sampling Activities for Split Core Sampler .....	45
6-7. Summary of Quality Control Checks and Acceptance Criteria for Field and Laboratory Parameters .....	50
7-1. Comparison of Expected and Actual Number of Sampling Attempts for Reference Samplers at Site 1 .....	54
7-2. Comparison of Expected and Actual Number of Sampling Attempts for Reference Sampler at Site 2 .....	55
7-3. Percent Sample Recovery Summary Statistics for Reference Samplers .....	58
7-4. Comparison of Target and Actual Core Length Data for Reference Samplers .....	59
7-5. Particle Size Distribution Summary Statistics for Hand Corer .....	63
7-6. Time Required to Complete Sampling Activities for Reference Samplers .....	64
8-1. Comparison of Investigation-Derived Waste Quantities Generated by Split Core Sampler and Reference Samplers .....	72

**Tables (Continued)**

<u>Table</u>	<u>Page</u>
8-2. Split Core Sampler Cost Summary .....	75
8-3. Hand Corer Cost Summary for S2A1 (Lake) .....	76
8-4. Vibrocorer Cost Summary for S1A1 (River Mouth) .....	77
8-5. Comparison of Costs for Split Core Sampler and Reference Samplers .....	78
9-1. Summary of Results for Primary Objectives .....	80
9-2. Summary of Results for Secondary Objectives .....	82
B-1. Ekman Grab Demonstration Design .....	93
B-2. Rationale for Sampling Approach .....	96
B-3. Ekman Grab Sample Matrix .....	97
B-4. Comparison of Expected and Actual Number of Sampling Attempts for Ekman Grab at Site 1 .....	98
B-5. Comparison of Expected and Actual Number of Sampling Attempts for Ekman Grab in S2A1 (Lake) .....	98
B-6. Percent Sample Recovery Summary Statistics for Ekman Grab .....	99
B-7. Comparison of Target and Actual Sediment Thickness Data for Ekman Grab .....	101
B-8. Particle Size Distribution Summary Statistics for Ekman Grab .....	103
B-9. Time Required to Complete Sampling Activities for Ekman Grab .....	104
B-10. Ekman Grab Cost Summary .....	105
C-1. Data Sets for Example Wilk-Shapiro Test Calculations .....	110
C-2. Hand Corer Sample Data for 4- to 12-Inch Below Sediment Surface Depth Interval in S2A2 (Wetland) .....	111
C-3. Hand Corer and Split Core Sampler Sample Data for 10- to 30-Inch Below Sediment Surface Depth Interval in S2A1 (Lake) .....	112

---

## Abbreviations, Acronyms, and Symbols

>	Greater than
≤	Less than or equal to
±	Plus or minus
<	Less than
AMS	Art's Manufacturing & Supply, Inc.
ASTM	American Society for Testing and Materials
BS/BSD	Blank spike/blank spike duplicate
bss	Below sediment surface
CFR	<i>Code of Federal Regulations</i>
DER	Data evaluation report
EPA	U.S. Environmental Protection Agency
ETV	Environmental Technology Verification
FLAA	Flame atomic absorption
ft	Foot
ft/s	Foot per second
GLNPO	Great Lakes National Program Office
ICP	Inductively coupled argon plasma
IDW	Investigation-derived waste
ITVR	Innovative technology verification report
L	Liter
lb	Pound
mg/kg	Milligram per kilogram
mg/L	Milligram per liter
mL	Milliliter
MMT	Monitoring and Measurement Technology
MS/MSD	Matrix spike/matrix spike duplicate
NA	Not applicable
NERL	National Exposure Research Laboratory
ORD	Office of Research and Development
OSWER	Office of Solid Waste and Emergency Response
PCB	Polychlorinated biphenyl
PE	Performance evaluation
PSD	Particle size distribution
PSR	Percent sample recovery
QA	Quality assurance
QA/QC	Quality assurance/quality control
QC	Quality control
RPD	Relative percent difference

---

## Abbreviations, Acronyms, and Symbols (Continued)

RSD	Relative standard deviation
S1A1	Site 1, Area 1
S1A2	Site 1, Area 2
S2A1	Site 2, Area 1
S2A2	Site 2, Area 2
SITE	Superfund Innovative Technology Evaluation
SOP	Standard operating procedure
Statistix <sup>®</sup>	Statistix <sup>®</sup> for Windows, Version 2.0
TCLP	Toxicity characteristic leaching procedure
Tetra Tech	Tetra Tech EM Inc.
TSA	Technical system audit

---

## Acknowledgments

This report was prepared for the U.S. Environmental Protection Agency (EPA) Superfund Innovative Technology Evaluation (SITE) Program under the direction and coordination of Dr. Stephen Billets and Dr. Brian Schumacher of the EPA National Exposure Research Laboratory—Environmental Sciences Division in Las Vegas, Nevada. The SITE Program thanks Mr. Joseph LeMay and Mr. Andy Beliveau of EPA Region 1, Mr. Robert Paulson of the Wisconsin Department of Natural Resources, and Mr. Marc Tuchman and Mr. Scott Cieniawski of the EPA Great Lakes National Program Office for their support in conducting field activities for this project. Mr. Jonathan Kuhns of Hawk Consulting and Dr. Larry Jackson of Environmental Quality Management served as the peer reviewers of this report.

This report was prepared for the EPA by Dr. Kirankumar Topudurti, Mr. Eric Monschein, and Mr. Andrew Bajorat of Tetra Tech EM Inc. Special acknowledgment is given to Ms. Jeanne Kowalski, Mr. Jon Mann, Mr. Stanley Labunski, Ms. Sandy Anagnostopoulos, Ms. Amy Stephen, Mr. Gary Sampson, and Mr. Bob Overman for their assistance during the preparation of this report.

---

## Chapter 1 Introduction

The U.S. Environmental Protection Agency (EPA) Office of Research and Development's (ORD) National Exposure Research Laboratory (NERL) has conducted a demonstration of an innovative sediment sampler known as the Split Core Sampler for Submerged Sediments, a core sampler designed and fabricated by Art's Manufacturing & Supply, Inc. (AMS), of American Falls, Idaho. In this innovative technology verification report (ITVR), the AMS Split Core Sampler for Submerged Sediments is referred to as the Split Core Sampler. The demonstration was conducted under the EPA Superfund Innovative Technology Evaluation (SITE) Program at two sites during the last week of April and first week of May 1999. The purpose of this demonstration was to obtain reliable performance and cost data on the Split Core Sampler in order to (1) achieve a better understanding of the sampler's capabilities relative to conventional sediment samplers and (2) provide an opportunity for the sampler to enter the marketplace and compete with conventional samplers without long delays.

This ITVR presents the performance results of the demonstration and associated costs for the Split Core Sampler. Specifically, this report describes the SITE Program and the scope of the demonstration (Chapter 1), innovative sediment sampler that was demonstrated (Chapter 2), two demonstration sites (Chapter 3), demonstration approach (Chapter 4), conventional sediment samplers used as reference samplers during the demonstration (Chapter 5), performance of the innovative sampler (Chapter 6), performance of the reference samplers (Chapter 7), economic analysis for the innovative and reference samplers (Chapter 8), demonstration results in summary form (Chapter 9), and references used to prepare the ITVR (Chapter 10). AMS claims for, updates on, and information on previous deployments of the innovative sampler are provided in Appendix A.

Appendix B presents performance results for the Ekman Grab, a conventional grab sampler that was included in the demonstration because grab samplers are commonly used to collect surficial sediment in order to assess the horizontal distribution of sediment characteristics. Appendix C describes the statistical methods used, as appropriate, to address the primary objectives for the demonstration.

### 1.1 Description of the SITE Program

Performance verification of innovative environmental technologies is an integral part of the regulatory and research mission of the EPA. The SITE Program was established by the EPA Office of Solid Waste and Emergency Response (OSWER) and ORD under the Superfund Amendments and Reauthorization Act of 1986. The primary purpose of the SITE Program is to promote acceptance and use of innovative sampling, monitoring, measurement, and treatment technologies.

The overall goal of the SITE Program is to conduct research and performance verification studies of innovative technologies that may be used to achieve long-term protection of human health and the environment. The various components of the SITE Program are designed to encourage development, demonstration, acceptance, and use of innovative sampling, monitoring, measurement, and treatment technologies. The program is designed to meet four primary objectives: (1) identify and remove obstacles to development and commercial use of innovative technologies, (2) support a development program that identifies and nurtures emerging technologies, (3) demonstrate promising innovative technologies to establish reliable performance and cost information for site characterization and cleanup decision-

making, and (4) develop procedures and policies that encourage use of innovative technologies at Superfund sites as well as at other waste sites and commercial facilities.

The intent of a SITE demonstration is to obtain representative, high-quality performance and cost data on one or more innovative technologies so that potential users can assess a given technology's suitability for a specific application. The SITE Program includes the following elements:

- **Monitoring and Measurement Technology (MMT) Program**—Evaluates technologies that sample, detect, monitor, and measure hazardous and toxic substances. These technologies are expected to provide better, faster, and more cost-effective methods for producing real-time data during site characterization and remediation studies than do conventional technologies.
- **Remediation Technology Program**—Conducts demonstrations of innovative treatment technologies to provide reliable performance, cost, and applicability data for site cleanups.
- **Technology Transfer Program**—Provides and disseminates technical information in the form of updates, brochures, and other publications that promote the SITE Program and technologies. It also offers technical assistance, training, and workshops to support the technologies.

The innovative sediment sampler demonstration was conducted as part of the MMT Program, which provides developers of innovative hazardous waste sampling, monitoring, and measurement technologies with an opportunity to demonstrate their technologies' performance under actual field conditions. These technologies may be used to sample, detect, monitor, or measure hazardous and toxic substances in soil, sediment, waste material, or groundwater. The technologies include chemical sensors for in situ (in place) measurements, groundwater samplers, soil and sediment samplers, soil gas samplers, laboratory and field-portable analytical equipment, and other systems that support field sampling or data acquisition and analysis.

The MMT Program promotes acceptance of technologies that can be used to accurately assess the degree of contamination at a site, provide data to evaluate potential effects on human health and the environment, apply data to assist in selecting the most appropriate cleanup action, and monitor the effectiveness of a remediation process. The program places a high priority on innovative technologies that provide more cost-effective, faster, and safer methods for producing real-time or near-real-time data than do conventional technologies. These innovative technologies are demonstrated under field conditions, and the results are compiled, evaluated, published, and disseminated by ORD. The primary objectives of the MMT Program are as follows:

- Test field sampling and analytical technologies that enhance sampling, monitoring, and site characterization capabilities
- Identify performance attributes of innovative technologies to address field sampling, monitoring, and characterization problems in a more cost-effective and efficient manner
- Prepare protocols, guidelines, methods, and other technical publications that enhance acceptance of these technologies for routine use

The MMT Program is administered by the Environmental Sciences Division of NERL in Las Vegas, Nevada. The NERL is the EPA's center for investigation of technical and management approaches for identifying and quantifying risks to human health and the environment. The NERL's mission components include (1) developing and evaluating methods and technologies for sampling, monitoring, and characterizing water, air, soil, and sediment; (2) supporting regulatory and policy decisions; and (3) providing the technical support needed to ensure effective implementation of environmental regulations and strategies. By demonstrating selected innovative sediment samplers, the MMT Program is supporting development and evaluation of methods and technologies for sampling and characterizing sediment.

The MMT Program's technology performance verification process is designed to conduct demonstrations that will generate high-quality data that potential users can employ

to verify technology performance and cost. Four key steps are inherent in the process: (1) needs identification and technology selection, (2) demonstration planning and implementation, (3) report preparation, and (4) information distribution.

The first step of the technology performance verification process begins with identifying technology needs of the EPA and regulated community. The EPA regional offices, the U.S. Department of Energy, the U.S. Department of Defense, industry, and state environmental regulatory agencies are asked to identify technology needs for sampling, monitoring, and measurement of environmental media. Once a need is identified, a search is conducted to identify suitable technologies that will address the need. The technology search and identification process consists of examining industry and trade publications, attending related conferences, exploring leads from technology developers and industry experts, and reviewing responses to *Commerce Business Daily* announcements. Selection of technologies for field testing includes evaluation of the candidate technologies based on several criteria. A suitable technology for field testing

- Is designed for use in the field
- Is applicable to a variety of environmentally contaminated sites
- Has potential for solving problems that current methods cannot satisfactorily address
- Has estimated costs that are competitive with those of current methods
- Is likely to achieve better results than current methods in areas such as data quality and turnaround time
- Uses techniques that are easier and safer than current methods
- Is commercially available

Once candidate technologies are identified, their developers are asked to participate in a developer conference. This conference gives the developers an opportunity to describe their technologies' performance and to learn about the MMT Program.

The second step of the technology performance verification process is to plan and implement a demonstration that will generate high-quality data that potential users can employ to verify technology performance and cost. Demonstration planning activities include a predemonstration sampling and analysis investigation that assesses existing conditions at the proposed demonstration site or sites. The objectives of the predemonstration investigation are to (1) confirm available information on applicable physical, chemical, and biological characteristics of contaminated media at the sites to justify selection of site areas for the technology demonstration; (2) provide the technology developers with an opportunity to evaluate the areas and identify logistical requirements; (3) determine the overall logistical requirements for conducting the demonstration; and (4) provide the analytical laboratories with an opportunity to identify any matrix-specific analytical problems associated with contaminated media and propose appropriate solutions. Information generated through the predemonstration investigation is used to develop the demonstration design and sampling and analysis procedures.

Demonstration planning activities also include preparation of a demonstration plan that describes the procedures to be used to verify the performance and cost of each innovative technology. The demonstration plan incorporates information generated during the predemonstration investigation as well as input from technology developers and demonstration site representatives. The demonstration plan also incorporates the quality assurance and quality control (QA/QC) elements needed to produce data of sufficient quality to document the performance and cost of each technology.

During the technology performance verification process, each innovative technology is evaluated independently and, when possible, against a reference technology. The performance of a developer or innovative technology is not compared to that of another developer or innovative technology. Rather, demonstration data are used to evaluate the performance, cost, advantages, limitations, and field applicability of each technology.

As part of the third step of the technology performance verification process, the EPA publishes a verification statement and a detailed evaluation of each technology in



an ITVR. To ensure its quality, the ITVR is published only after comments from the technology developer and external peer reviewers are satisfactorily addressed. All demonstration data used to evaluate each innovative technology are summarized in a data evaluation report (DER) that constitutes a record of the demonstration. The DER is not published by the EPA, but an unpublished copy may be obtained by contacting the EPA project manager, Dr. Stephen Billets.

The fourth step of the technology performance verification process is to distribute demonstration information. The EPA distributes ITVRs free of charge through direct mailings, at conferences, and on the Internet to benefit technology developers and potential technology users. ITVRs are available on the Internet through the Hazardous Waste Clean-Up Information web site supported by the EPA OSWER Technology Innovation Office (<http://www.clu-in.org>). Additional information on the SITE Program is provided at the ORD web site (<http://www.epa.gov/ORD/SITE>).

## 1.2 Scope of the Demonstration

Environmental sediment sampling is conducted to characterize sediment at a particular location. Sediment characterization may involve biological analyses (for biological availability and benthic biota), chemical analyses (for organic and inorganic contaminants), and physical analyses (for color, texture, and particle size distribution [PSD]). Sediment samplers are typically designed to collect discrete samples of sufficient quantity and quality at a predetermined depth relatively easily and in a reasonable amount of time. Although the samplers now being used meet most sediment sampling requirements, innovative samplers may be faster and easier to operate, less expensive, and more accurate and precise.

The MMT Program members involved in the Split Core Sampler demonstration included the EPA NERL, the EPA National Risk Management Research Laboratory, EPA Region 1, the Wisconsin Department of Natural Resources, the EPA Great Lakes National Program Office (GLNPO), and AMS.

The performance of the Split Core Sampler was demonstrated and compared to that of conventional

sediment samplers in order to provide evidence that the Split Core Sampler worked as intended and to facilitate its use. The conventional sediment samplers, which are referred to as reference samplers herein, are described in Chapter 5. For the demonstration, either a Hand Corer or a Vibrocorer was used as a reference sampler, depending on site conditions and sampler availability.

In addition to the Split Core Sampler, AMS was given the opportunity to substitute one alternate innovative sampler if AMS believed that the alternate sampler was better suited for the conditions and objectives being addressed in a particular sampling area. Because the Split Core Sampler was not designed to collect core samples more than 48 inches below sediment surface (bss), AMS attempted to demonstrate the AMS Dual Tube Liner Sampler in one demonstration area to collect samples in the 4- to 6-foot bss depth interval. However, while attempting to deploy the Dual Tube Liner Sampler during a practice run, AMS could not control the sampler's deployment into the sediment because of its heavy weight. As a result, AMS elected not to demonstrate the Dual Tube Liner Sampler in this area.

AMS also attempted to demonstrate the Dual Tube Liner Sampler in one demonstration area in order to collect samples in the 9- to 11-foot bss depth interval. However, because AMS did not have all the sampler components on hand at the time, AMS could not demonstrate the Dual Tube Liner Sampler in this area.

A conventional grab sampler was also included in the demonstration because grab samplers are commonly used to collect surficial sediment in order to assess the horizontal distribution of sediment characteristics. The Ekman Grab, a commonly used grab sampler, was chosen for the demonstration. Performance and cost data collected for the Ekman Grab are not compared to those for the Split Core Sampler but rather are presented in Appendix B as supplemental information.

The demonstration had both primary and secondary objectives. The primary objectives were critical to the technology evaluation and required use of quantitative results to draw conclusions regarding technology performance. The secondary objectives pertained to information that was useful but did not necessarily require use of quantitative results to draw conclusions regarding technology performance. Based on available historical

---

data for the demonstration sites, the primary objectives required use of chemical and physical characterization of sediment but not biological characterization. The primary and secondary objectives are presented in Chapter 4.

To meet the demonstration objectives, individual areas at two sites were selected for conducting the demonstration. The first site is referred to as Site 1; it included two areas and lies in EPA Region 5. The second site is referred to as Site 2; it included two areas and lies in EPA Region 1. These sites and areas are described in Chapter 3.

In preparation for the demonstration, a predemonstration sampling and analysis investigation was completed at

the two sites in February 1999. The purpose of this investigation was to assess whether the sites were appropriate for evaluating the Split Core Sampler based on the demonstration objectives. The demonstration was conducted during the last week of April and first week of May 1999. The procedures used to verify the performance and cost of the Split Core Sampler are summarized in a demonstration plan completed in April 1999 (EPA 1999). The demonstration plan also incorporates the QA/QC elements needed to generate data of sufficient quality to document innovative and reference sampler performance and cost. The plan is available on the Internet through the ORD web site (<http://www.epa.gov/ORD/SITE>).

---

## Chapter 2

### Description of the Innovative Sediment Sampler

Core samplers are commonly used to collect sediment profiles in order to assess the vertical distribution of sediment characteristics. Based on the method of sample collection, core samplers may be broadly classified in two categories: (1) side-filling core samplers and (2) end-filling core samplers (Faegri and Iversen 1989). A side-filling core sampler is operated by first driving the sampler to a particular depth. The core tube is then rotated clockwise to fill the tube by cutting out a segment of sediment. A large cover plate attached to the core tube holds the sampler stationary while the tube rotates clockwise to collect the sediment. Resistance offered by the sediment keeps the cover plate stationary, allowing the core tube to rotate. Examples of side-filling samplers include the Russian sampler and the Hiller sampler (Faegri and Iversen 1989). Additional details on side-filling samplers are provided by Environment Canada (1994), Faegri and Iversen (1989), Aaby and Digerfeldt (1986), Jowsey (1966), and Belokopytov and Beresnevich (1955).

An end-filling core sampler typically consists of one or more core tubes or a box that collects sediment from the bottom end of the sampler as it is pushed through the sediment. An end-filling sampler generally collects sediment from the sediment surface down to a particular depth. Once the core sample is extruded through the end of the sampler, a discrete depth interval of the core sample may be subsampled. Examples of end-filling samplers include the Hand Corer, Split Core Sampler, Dual Tube Liner Sampler, and Vibrocorer. Additional details on end-filling samplers are provided by Environment Canada (1994), Blomqvist (1991), Faegri and Iversen (1989), Aaby and Digerfeldt (1986), and Downing (1984).

This chapter describes the Split Core Sampler designed and fabricated by AMS. This end-filling sampler is designed to collect undisturbed, cylindrical core samples

of various types of sediment, including saturated sands and silts, to a maximum depth of 48 inches bss. The sampler is designed to collect sediment with a particulate diameter not exceeding 2/3 inch. Sections 2.1 through 2.4 describe the Split Core Sampler, discuss its general operating procedures, outline its advantages and limitations, and provide developer contact information. Similar information for the reference samplers used during the demonstration is provided in Chapter 5.

#### 2.1 Sampler Description

Components of the Split Core Sampler include (1) 6- and 12-inch-long pairs of 300-series, stainless-steel split core tubes with interlocking, recessed channels and male, square-threaded ends; (2) a 400-series, stainless-steel coring tip; (3) a plastic basket retainer with flexible leaves; (4) a ball check valve-vented top cap; (5) a male, threaded top cap coupling; (6) a female, square-threaded coupling for attachment to additional stainless-steel split core tubes; and (7) stainless-steel or carbon-steel (4130 alloy) AMS extension rods available in 3-, 4-, and 5-foot lengths (see Figure 2-1). The sampler can be operated with a stainless-steel or rubber-coated AMS cross handle, an AMS slide-hammer (6, 10, or 19 pounds [lb]), or an electric hammer. The sampler can also be equipped with core tube liners that fit inside the split core tubes and facilitate removal of an intact sample. Core tube liners are available in plastic, stainless steel, brass, aluminum, and Teflon<sup>®</sup>; end caps made of plastic are also available. Additional support equipment for sampler deployment may include an SDS Max self-locking adapter for attaching an electric hammer to the extension rod, an AMS Sample Preparation Station for splitting core tube liners and examining samples, and an extrusion rod. The extrusion rod used during the demonstration consisted of a plunger attached to a

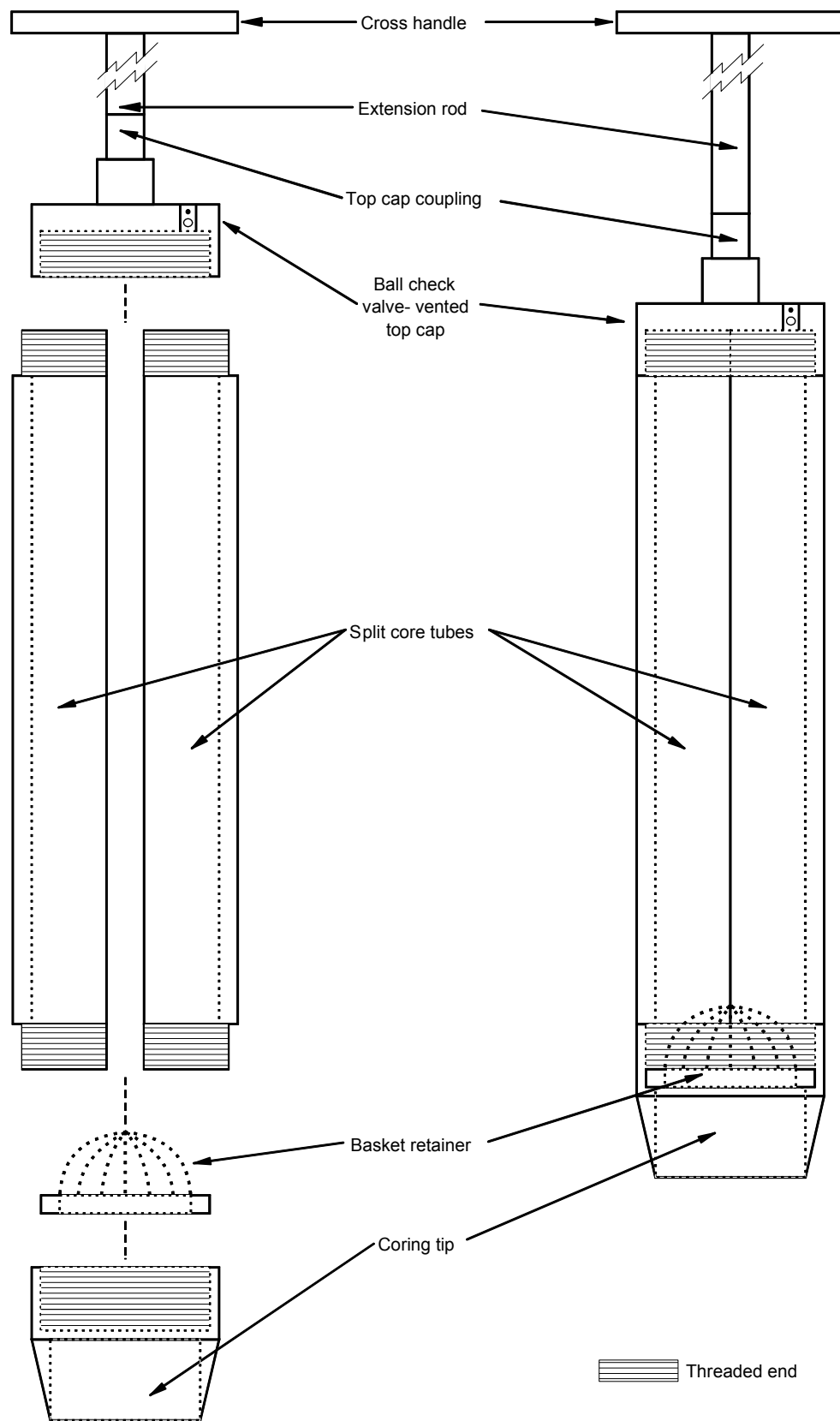

Figure 2-1. Split Core Sampler.

graduated rod. An AMS tripod-mounted winch may also be used to assist the sampling technician in dislodging and retrieving the sampler from the sediment.

The assembled Split Core Sampler has an inside diameter of 2 inches and is designed to collect about 50 milliliters (mL) of sediment per inch of core tube length. The fully equipped sampler (including one pair of 2-inch-diameter, 12-inch-long split core tubes; the ball check valve-vented top cap; the coring tip; the coupling; one 12-inch-long, disposable, plastic core tube liner with end caps; one 4-foot-long, carbon-steel extension rod; and one rubber-coated cross handle) weighs about 10 lb.

The Split Core Sampler can be either manually pushed into sediment using the AMS cross handle or hammered into sediment using the AMS slide-hammer or an electric hammer. The sampler can be removed from sediment either manually, by reverse hammering using the AMS slide-hammer, or with the AMS tripod-mounted winch.

The Split Core Sampler is innovative because it incorporates a ball check valve-vented top cap that (1) allows air and water to exit the sampler during deployment, (2) prevents water from entering the sampler during retrieval, and (3) creates a vacuum to help retain a sediment core during sampler retrieval. Also, the coring tip of the sampler has been modified from earlier versions of the sampler to accommodate the plastic basket retainer, which is designed to help prevent sample loss as the sampler is retrieved.

## 2.2 General Operating Procedures

The Split Core Sampler can be operated by one person from a platform, from a boat, or while wading in shallow water. Depending on sampler decontamination requirements and sampling conditions such as water depth and sediment type, the AMS stainless-steel extension rods or the stronger, more widely used AMS carbon-steel extension rods are attached to the sampler before its deployment. During sampler assembly, a core tube liner may be inserted into the split core tube. The core tube liner holds and stores the sample for later examination.

The fully assembled sampler is manually lowered into the water in such a way that the coring tip is placed on the sediment surface. The speed of sampler deployment to the

sediment surface should be controlled to (1) allow air and water to escape from the sampler through the ball check valve in order to avoid bow wave formation, which could disturb flocculent or unconsolidated sediment that might be near the sediment surface, and (2) ensure that the pressures inside and outside the sampler are equalized when the sampler touches the sediment surface.

The sampler can then be either manually pushed with the AMS cross handle or driven with the AMS slide-hammer or an electric hammer to the desired sediment depth. An electric hammer, which induces vibrations in the sampler, should be used when possible for more efficient recovery of sediment samples. The sampling technician should practice sampler deployment to determine whether the AMS slide-hammer or an electric hammer is needed. Irrespective of the deployment mechanism used, the sampler should be driven into the sediment in a steady manner.

The sampler is removed from the sediment either manually by reverse hammering using the AMS slide-hammer or with the AMS tripod-mounted winch. The sampler should be raised out of the water either manually or using the AMS tripod-mounted winch when the weight of the sampler and extension rods requires it. When the sampler is being retrieved, the sampler should be kept vertical, and the rate of retrieval should be kept as steady as possible to minimize resuspension and disruption of the sediment. The tapered coring tip, the plastic basket retainer at the bottom of the sampler, and the partial vacuum created by the ball check valve-vented top cap retain the sediment core within the split core tube.

Once the sampler has been retrieved, either the interlocking split core tubes are disassembled or the coring tip or top cap is removed to allow removal of the core tube liner. The sediment core enclosed in the core tube liner can be sealed in the core tube liner using two core tube liner end caps or can be extruded for further examination and processing. The sediment core may be extruded by pushing the sample out one end of the core tube liner with an extrusion rod or by cutting the core tube liner open longitudinally, if the liner is made of plastic, using the AMS Sample Preparation Station.

## 2.3 Advantages and Limitations

The Split Core Sampler is easy to operate, requiring minimal skills and training. Sampler assembly and sample

collection procedures can be learned in the field with a few practice attempts. In addition, a written standard operating procedure (SOP) accompanies the sampler when it is procured. The sampler can be operated by one person in both shallow (wading) and deep water depths because of its lightness (10 lb). In addition, the sampling technician can use one or a combination of the 6- and 12-inch-long pairs of stainless-steel split core tubes to collect 6- to 48-inch-long sediment cores. Sampler operation is especially simple when a plastic core tube liner is used because the sampler does not require complete disassembly to extrude the sample and reassembly after each sampling attempt. Only the coring tip or top cap has to be detached in order to remove the core tube liner containing the sediment core. Use of the disposable liner also minimizes the risk of cross-contamination between sampling locations.

Another advantage of the Split Core Sampler is the ball check valve-vented top cap. This top cap is designed to (1) allow air and water to exit the sampler during deployment, (2) prevent water from entering the sampler during retrieval, and (3) create a vacuum to help retain a sediment core during sampler retrieval. Collectively, these design features increase the likelihood of collecting an undisturbed sample.

A limitation of the Split Core Sampler is that during sampler deployment, the core tube liner is exposed to different layers of sediment contamination. Contaminants may adhere to the exposed surface of the liner while the sampler passes through different layers of sediment. Also, the ball check valve-vented top cap may become clogged if the sampler is deployed in such a way that the top cap is below the sediment surface. Therefore, the ball check valve must be inspected after every sampling attempt; if the valve is clogged, the top cap should be removed to allow adequate cleaning of the valve.

The Split Core Sampler cannot collect discrete samples from various sediment depths. Core samples must be collected from the sediment surface downward. Because

end-filling samplers such as the Split Core Sampler must collect samples from the sediment surface downward, the Split Core Sampler is subject to core shortening. Core shortening occurs when the length of sediment core collected is less than the depth of sampler penetration into the sediment. Core shortening may occur when the friction of the sediment against the inside wall of the core tube increases with increasing depth of sediment penetration, causing lateral displacement of sediment and resulting in gradually thinner increments of sediment entering the sampler. Because not all layers are uniformly sampled, core shortening can introduce sampling bias.

For efficient recovery of sediment samples, an electric hammer should be used to induce vibrations in the sampler. Because an external power source is required to operate the electric hammer, the sampling platform must be able to accommodate the weight and size of a portable generator. Furthermore, if the sampling platform is not already equipped with a winch system and an access hole, use of the AMS tripod-mounted winch or similar device limits the sampling platform locations from which the sampler can be deployed. Specifically, use of the tripod-mounted winch requires that the sampling platform be equipped with a hole over which the tripod-mounted winch can be placed and through which the sampler can be deployed.

## 2.4 Developer Contact Information

Additional information about the Split Core Sampler can be obtained from the following source:

Mr. Brian Anderson  
Art's Manufacturing & Supply, Inc.  
105 Harrison  
American Falls, ID 83211  
Telephone: (208) 226-2017  
Fax: (208) 226-7280  
E-mail: [briana@bankpds.com](mailto:briana@bankpds.com)  
Internet: [www.ams-samplers.com](http://www.ams-samplers.com)

## Chapter 3 Demonstration Site Descriptions

This chapter discusses the two sites selected for conducting the Split Core Sampler demonstration. The first site is referred to as Site 1 and includes two areas along a river in EPA Region 5. The second site is referred to as Site 2 and includes two areas along a river in EPA Region 1. After a review of the information available on these and other candidate sites, Sites 1 and 2 were selected based on the following criteria:

- **Site Diversity**—Each site consisted of multiple sampling areas with the different water depths, flow regimes, sediment types, sediment contaminant characteristics, and sediment thicknesses necessary to evaluate the Split Core Sampler.
- **Access and Cooperation**—Site representatives were interested in supporting the demonstration by providing historical data and site access.

In February 1999, a predemonstration sampling and analysis investigation was conducted to assess existing site conditions and to confirm information provided by EPA Regions 1 and 5. The predemonstration investigation results summarized in Table 3-1 were used to develop the demonstration design for the innovative and reference samplers. The following sections provide brief descriptions of the two demonstration sites.

### 3.1 EPA Region 5 Site (Site 1)

Site 1 consists of sections of a river in EPA Region 5. Two areas along the river were selected as demonstration areas. These areas and the sampling platforms used are briefly described below and are shown in Figure 4-1.

#### 3.1.1 Site 1, Area 1

Site 1, Area 1 (S1A1) lies at the river mouth, which is about 0.5 mile wide. The area generally represents an open-water condition. During the demonstration, the average water velocity in this area was equal to or less than 0.07 foot per second (ft/s). The water depth in the vicinity of S1A1 ranged from about 5 to 6 feet. Sampling in S1A1 was conducted using the EPA GLNPO's *Mudpuppy*, a 32-foot-long, 8-foot-wide, twin-motor, flat-bottom boat specifically designed for sediment sampling in rivers and harbors. The boat is equipped with a vibrocoring unit supported by an A-frame and winch that allows collection of sediment cores up to 15 feet long. Additional features that make the *Mudpuppy* a suitable platform for conducting vibrocoring or other sediment sampling include the following:

- A sampling platform at the bow of the boat with a hole in the middle wide enough to accommodate the vibrocoring unit
- Adequate deck space for subsampling and processing 15-foot-long core samples
- A differentially corrected global positioning system with submeter accuracy that allows precise and accurate determination of sampling locations
- Four anchor lines for maintaining the boat's position over sampling locations
- An electrical power source for support equipment

**Table 3-1. Demonstration Area Characteristics**

Demonstration Area	Average Water Velocity <sup>a</sup> (ft/s)	Water Depth <sup>a</sup> (ft)	Predemonstration Investigation Results		
			Target Sampling Depth Interval (inches bss)	Contaminant	Physical Characteristics
S1A1 (river mouth)	≤ 0.07	5 to 6	0 to 4	PCBs	Unconsolidated sediment containing primarily sand with some silt and little clay
			4 to 12	PCBs	Consolidated sediment containing primarily sand and silt with some clay
S1A2 (freshwater bay)	< 0.05	2	0 to 6	PCBs	Unconsolidated sediment containing primarily sand and silt with some clay
			12 to 36	None <sup>b</sup>	Consolidated sediment containing primarily silt with some sand and clay
S2A1 (lake)	< 0.05	18	0 to 4	Arsenic	Unconsolidated sediment containing primarily silt with some sand and clay
			10 to 30	Arsenic	Consolidated sediment containing primarily sand with some silt and little clay
S2A2 (wetland)	< 0.05 to 0.7	0.5 to 1.5	4 to 12	Arsenic	Consolidated sediment containing primarily sand with some silt and little clay

Notes:

- ≤ = Less than or equal to                      ft = Foot
- < = Less than                                      ft/s = Foot per second
- bss = Below sediment surface                PCB = Polychlorinated biphenyl

<sup>a</sup> Average water velocity and water depth represent data collected during the actual demonstration.

<sup>b</sup> No measurable PCB contamination was present in this depth interval.

Predemonstration investigation sample analytical results for S1A1 indicated that polychlorinated biphenyl (PCB) contamination in the 0- to 4-inch bss depth interval was minimal. However, the 4- to 12-inch bss depth interval in this area had the highest levels of PCB contamination of any depth interval sampled during the predemonstration investigation. Based on the PSD data, sediment in the 0- to 4-inch bss depth interval was predominantly sand with some silt and little clay. PSD in the 4- to 12-inch bss depth interval was predominantly sand and silt with some clay. Sediment in the 0- to 4-inch bss depth interval was unconsolidated and became increasingly consolidated with depth. During the demonstration, a clay hardpan was encountered at about 5 feet bss in the sampling area. Based on the PCB and PSD data from the predemonstration investigation, the sediment in the 0- to 4-inch bss depth interval in S1A1 appeared to be chemically and physically homogenous. However, the sediment in the 4- to 12-inch bss depth interval in this area did not appear to be as chemically or physically homogenous as was the case in Site 1, Area 2 (S1A2).

### 3.1.2 Site 1, Area 2

S1A2 is about 11 miles upstream of S1A1. The river is about 2,000 feet wide in S1A2. A small, protected bay is present along the river channel's bank at this location. This bay has a very slow-moving current and, because of its configuration, backflow conditions. During the demonstration, the average water velocity in the area was less than 0.05 ft/s. The water depth in the bay was about 2 feet. Sampling in S1A2 was conducted within the bay using an 18-foot-long, 4-foot-wide, flat-bottom Jon boat. The boat was equipped with a single engine, a set of oars, and a single anchor line for positioning the boat over sampling locations. The *Mudpuppy* could not be used to conduct sampling in S1A2 because the water in this area was too shallow (the *Mudpuppy* requires a minimum water depth of about 3 feet).

Predemonstration investigation sample analytical results for S1A2 indicated that PCB contamination in the 0- to 6-inch bss depth interval was minimal but greater than that



in the 0- to 4-inch bss depth interval in S1A1. Furthermore, the 12- to 36-inch bss depth interval in S1A2 had no measurable PCB contamination. Sediment in the 0- to 6-inch bss depth interval was predominantly sand and silt with some clay. Sediment in the 12- to 36-inch bss depth interval was predominantly silt with some sand and clay. Sediment in the top few inches was unconsolidated and became consolidated with increasing depth. Based on the PSD data from the predemonstration investigation, sediment in the 12- to 36-inch bss depth interval in S1A2 appeared to be the most physically homogenous at Site 1.

### 3.2 EPA Region 1 Site (Site 2)

Site 2 consists of sections of a river in EPA Region 1. The river, which has a moderate flow, runs through a low-lying wetland area and empties into a lake. Two areas along the river were selected as demonstration areas. These areas and the sampling platforms used are briefly described below and are shown in Figure 4-2.

#### 3.2.1 Site 2, Area 1

Site 2, Area 1 (S2A1) is a lake located about 5 miles downstream of Site 2, Area 2 (S2A2). During the demonstration, the average water velocity in the area was less than 0.05 ft/s, and the water depth was about 18 feet. Sampling in S2A1 was conducted using a 30-foot-long, 8-foot-wide pontoon boat. The pontoon boat was equipped with a single engine and eight anchor lines for positioning the boat over sampling locations. In addition, a 6-inch-diameter hole was provided in the middle of the boat to allow use of a core sampler with a tripod-mounted winch. The front and sides of the boat would not accommodate a tripod-mounted winch.

Predemonstration investigation sample analytical results for S2A1 indicated that the 0- to 4-inch bss depth interval in this area had more consistent and higher levels of arsenic contamination and more consistent PSD than was the case in S2A2. Arsenic contamination in the 0- to 4-inch bss depth interval in S2A1 was an order of magnitude greater than that in the 10- to 30-inch bss depth

interval. Sediment in the 0- to 4-inch bss depth interval was predominantly silt with some sand and clay. Sediment in this depth interval was unconsolidated. Sediment in the 10- to 30-inch bss depth interval was predominantly sand with some silt and little clay. Based on the arsenic and PSD data from the predemonstration investigation, the sediment in the 10- to 30-inch bss depth interval in S2A1 appeared to be the most chemically and physically homogenous sediment at Site 2.

#### 3.2.2 Site 2, Area 2

S2A2 is near a low-lying wetland along the river. This area is about 5 miles upstream of S2A1. The river channel is about 10 feet wide in S2A2. Water flow in this area is low to moderate, reflecting seasonal variations. During the demonstration, the average water velocity in the area ranged from less than 0.05 to 0.7 ft/s, and water depths in the area ranged from about 0.5 to 1.5 feet. Sampling in S2A2 was conducted from wood planks fastened to two aluminum ladders extended across the river channel. Depending on the individual needs of each sampling technician, (1) samples were collected off the side of one ladder or (2) the sampling technician stood with one foot on each ladder to collect samples between the ladders.

At the time of the predemonstration investigation, the top 4 to 8 inches of sediment in S2A2 contained organic matter, primarily decomposed leaves and wood chips. Predemonstration investigation sample analytical results for S2A2 indicated that levels of arsenic contamination from the bottom of the organic layer down to 12 inches bss were nonuniform and lower than the levels in S2A1. In S2A2, sediment in the 4- to 12-inch bss depth interval (below the organic layer) was predominantly sand with some silt and little clay. Sediment in this depth interval was highly consolidated. Based on the arsenic and PSD data from the predemonstration investigation, S2A2 did not appear to be as chemically or physically homogenous as S2A1. In addition, historical data provided by EPA Region 1 indicated that a 30-foot-thick layer of peat existed below the sediment layer in S2A2.

## Chapter 4 Demonstration Approach

This chapter presents the demonstration objectives (Section 4.1), design (Section 4.2), field sampling and measurement procedures (Section 4.3), and laboratory sample preparation and analysis methods (Section 4.4).

### 4.1 Demonstration Objectives

The main intent of the SITE MMT Program is to develop reliable performance and cost data on innovative technologies. A SITE demonstration must provide detailed and reliable performance and cost data so that potential technology users have adequate information to make sound judgments regarding a technology's applicability to a specific site and to compare the technology to alternatives.

The Split Core Sampler demonstration had both primary and secondary objectives. Primary objectives were critical to the technology evaluation and required use of quantitative results to draw conclusions regarding technology performance. Secondary objectives pertained to information that was useful but did not necessarily require use of quantitative results to draw conclusions regarding technology performance.

The primary objectives for the innovative sediment sampler demonstration were as follows:

- P1. Evaluate whether the sampler can consistently collect a specified volume of sediment
- P2. Determine whether the sampler can consistently collect samples in a specified depth interval
- P3. Assess the sampler's ability to collect multiple samples with consistent physical or chemical

characteristics, or both, from a homogenous layer of sediment

- P4. Evaluate whether the sampler can collect a representative sample from a "clean" sediment layer that is below a contaminated sediment layer
- P5. Assess the sampler's ability to be adequately decontaminated between sampling areas
- P6. Measure the time required for each activity associated with sample collection (sampler setup, sample collection, sampler disassembly, and sampler decontamination)
- P7. Estimate costs associated with sample collection activities (sampler, labor, supply, investigation-derived waste [IDW] disposal, and support equipment costs)

The secondary objectives for the innovative sediment sampler demonstration were as follows:

- S1. Document the skills and training required to properly operate the sampler
- S2. Evaluate the sampler's ability to collect samples under a variety of site conditions
- S3. Assess the sampler's ability to collect an undisturbed sample
- S4. Evaluate the sampler's durability based on its materials of construction and engineering design
- S5. Document the availability of the sampler and spare parts

The objectives for the demonstration were developed based on input from MMT Program members, general user expectations of sediment sampler capabilities, characteristics of the demonstration areas, the time available to complete the demonstration, and sampler capabilities that AMS intended to highlight.

## 4.2 Demonstration Design

In February 1999, a predemonstration sampling and analysis investigation was conducted to assess existing conditions and confirm available information on physical and chemical characteristics in each demonstration area. Based on information from the predemonstration investigation as well as available historical data, a demonstration design was developed to address the demonstration objectives. Input regarding the demonstration design was obtained from demonstration site representatives and AMS. Table 4-1 summarizes the demonstration design.

AMS operated the Split Core Sampler in each demonstration area. The EPA made observations and took measurements to evaluate the Split Core Sampler in accordance with the demonstration objectives. In addition, a reference sampler was selected for each demonstration area either because the sampler had been successfully used to collect sediment samples in the particular demonstration area or because it is typically used to collect sediment samples under the conditions encountered in the particular area. The Vibrocorer was used as the reference sampler in S1A1. The Hand Corer was used as the reference sampler in S1A2, S2A1, and S2A2. Similarly, the sampling platforms used were selected based on their availability but not necessarily based on sampler requirements. For example, in S1A1, the EPA GLNPO's *Mudpuppy* was used because it was available free of charge from EPA Region 5. During the demonstration, each reference sampler was evaluated under the same conditions and objectives as the Split Core Sampler. All the sampling activities conducted by AMS for the Split Core Sampler were also conducted for the reference samplers by the sampling technicians (for example, the EPA GLNPO operated the Vibrocorer). During the use of each reference sampler, the EPA also took the same measurements and made the same

observations as were performed for the Split Core Sampler.

The Split Core Sampler and reference sampler for Site 2 were not designed to collect core samples from the 9- to 11-foot bss sampling depth interval. Therefore, in this sampling depth interval, the Split Core Sampler and reference sampler were not used. Because the Split Core Sampler was not designed to collect sediment cores in the 4- to 6-foot bss sampling depth interval at Site 1, the Split Core Sampler was also not demonstrated in this sampling depth interval. In addition, the Dual Tube Liner Sampler was not demonstrated in these sampling depth intervals for the reasons stated in Section 1.2.

The approach used to address each primary objective for the innovative and reference core samplers is discussed below. Because of varying sampler features, the characteristics of the demonstration areas, and the limited time available for the field demonstration, not all primary objectives were addressed in each demonstration area. However, the Split Core Sampler and a reference sampler were evaluated under three or more primary objectives in each demonstration area.

- To address primary objective P1, a volume of sediment to be collected was specified for each sampling depth interval. The volume specified was based on analytical requirements for characterizing the sample or on the design volume of the sampler for the particular sampling depth interval. If after one attempt the sampler had not retrieved the specified volume of sediment, additional attempts were made to retrieve the specified volume. The number of attempts required and the volume of sediment collected in each attempt at a given location within an area were noted.
- Primary objective P2 was addressed by verifying that each sediment sampler was able to consistently sample a specified depth interval. For each sampler, the depth of sampler deployment, total sample length, and sample length within the specified depth interval were noted. Various site conditions, including sediment depth, water depth, and sediment composition, were considered in addressing P2 in each demonstration area.

**Table 4-1. Innovative Sediment Sampler Demonstration Design**

Demonstration Area	Target Sampling Depth Interval (bss)	Primary Objective	Sampling Parameter (Matrix)	Volume Required per Sample	Sampler
S1A1 (river mouth)	0 to 4 inches	P1 Volume P2 Depth interval P6 Sample collection time	Core length and volume (sediment)	Design volume <sup>a</sup>	Split Core Sampler Vibrocorer
	6 to 12 inches	P1 Volume P2 Depth interval P5 Decontamination P6 Sample collection time P7 Cost	PCBs, volume, and core length (sediment)	250 mL	Split Core Sampler Vibrocorer
			PCBs (final rinsate)	1 L	
4 to 6 feet	P1 Volume P2 Depth interval P6 Sample collection time	Core length and volume (sediment)	Design volume	Dual Tube Liner Sampler Vibrocorer	
S1A2 (freshwater bay)	0 to 4 inches	P1 Volume P2 Depth interval P6 Sample collection time	Core length and volume (sediment)	Design volume	Split Core Sampler Hand Corer
	12 to 32 inches	P1 Volume P2 Depth interval P3 Consistent samples from a homogenous layer P6 Sample collection time	PSD, volume, and core length (sediment)	250 mL	Split Core Sampler Hand Corer
S2A1 (lake)	0 to 4 inches	P1 Volume P2 Depth interval P3 Consistent samples from a homogenous layer P4 Clean layer below contaminated layer P5 Decontamination P6 Sample collection time P7 Cost	Arsenic, PSD, volume, and core length (sediment)	250 mL	Split Core Sampler Hand Corer
			Arsenic (final rinsate)	500 mL	
	10 to 30 inches	P1 Volume P2 Depth interval P3 Consistent samples from a homogenous layer P4 Clean layer below contaminated layer P6 Sample collection time	Arsenic, PSD, volume, and core length (sediment)	250 mL	Split Core Sampler Hand Corer
S2A2 (wetland)	4 to 12 inches	P1 Volume P2 Depth interval P6 Sample collection time	Core length and volume (sediment)	Design volume	Split Core Sampler Hand Corer
	9 to 11 feet	P1 Volume P2 Depth interval P6 Sample collection time	Core length and volume (sediment)	Design volume	Dual Tube Liner Sampler

Notes:

- bss = Below sediment surface
- L = Liter
- mL = Milliliter
- PCB = Polychlorinated biphenyl
- PSD = Particle size distribution

<sup>a</sup> For a given depth interval, the design volume corresponds to 100 percent sample recovery.

- Primary objective P3 was addressed by analyzing samples collected in a homogenous sediment layer for arsenic or PSD. P3 was addressed in the deeper sampling depth interval in S1A2 and in both sampling depth intervals in S2A1. These areas and intervals were chosen for this purpose because, according to the analytical results for predemonstration investigation samples, these intervals exhibited relatively consistent chemical or physical characteristics or both.
  - Primary objective P4 was addressed by evaluating whether a sample could be collected from a layer of sediment with relatively low contaminant concentrations (a “clean” layer) beneath a “contaminated” layer of sediment that had significantly higher contaminant concentrations without cross-contaminating the clean layer sample. P4 was addressed in S2A1 because, according to the results of the predemonstration investigation, a clean layer of sediment was present beneath a relatively contaminated layer of sediment. During the demonstration, sediment samples were collected from each layer and analyzed for arsenic. The analytical data for these samples were used to determine whether sediment from the contaminated layer had been carried into the clean layer during sampler deployment and retrieval.
  - Primary objective P5 was addressed by collecting samples of equipment rinsate (water) during the final stage of core sampler decontamination. P5 was addressed in the deeper sampling depth interval in S1A1 and in the shallower sampling depth interval in S2A1 because sediment in these areas and intervals contained the highest observed concentrations of PCBs and arsenic, respectively, among the demonstration areas. Decontamination of each sampler demonstrated in a given area was performed after all samples had been collected in that area.
  - Primary objective P6 was addressed by measuring the time required for each activity associated with sample collection, including sampler setup, sample collection, sampler disassembly, and sampler decontamination. P6 was addressed in all demonstration areas to satisfy this objective under a variety of site conditions.
  - Primary objective P7 was addressed in S1A1 and S1A2 by estimating the costs associated with sample collection activities, including sampler, labor, IDW disposal, and support equipment costs. The following costs associated with collection of all the investigative samples in each area where P7 was addressed were accounted for:
    1. The sampler cost was estimated based on price lists for purchasing each sediment sampler; disposable, plastic core liners (if applicable); and support equipment. Leasing costs for the samplers were not considered because the samplers are unavailable for leasing.
    2. The labor cost was estimated based on the number of people required to operate each sediment sampler and the time required to conduct sampling activities (sampler setup, sample collection, sampler disassembly, and sampler decontamination).
    3. The IDW disposal cost was estimated for specified areas. A volume of sediment to be collected was specified for each demonstration area where P7 was addressed. For each such area, any sediment collected by a sampler that was not required for analytical purposes was considered to be IDW. For example, the sediment collected above and below the specified depth interval and the portion of a sample exceeding the specified volume within a given depth interval were considered to be IDW.
    4. The support equipment cost was estimated based on the rental or purchase cost of any additional equipment required for sample collection, such as generators or winches needed at the time of the demonstration.
- Secondary objectives S1, S2, and S3 were addressed in all the demonstration areas where a given sampler was evaluated because no additional sampling was required to address them. Secondary objectives S4 and S5 were not area-dependent; they were addressed based on developer information as well as observations of sampler performance during the demonstration. The approach used to address each secondary objective is discussed below.

- Secondary objective S1 was addressed by observing and noting the skills required to operate each sampler during the demonstration, how easy the sampler was to operate, and the sampler's approximate weight and by discussing any necessary sampling technician training with the developer.
- Secondary objective S2 was addressed by determining each sampler's ability to collect sediment samples given the variety of sampling platforms, water depths, sediment depths, sediment compositions, and flow conditions encountered in the demonstration areas.
- Secondary objective S3 was addressed based on visual observations made during sampling or after a sediment sample had been extruded from a sampler.
- Secondary objective S4 was addressed by noting each sampler's materials of construction. Sediment sampler failures or repairs that were necessary during use of the sampler were also noted.
- Secondary objective S5 was addressed by discussing the availability of replacement samplers with the developer and determining whether spare parts were available in a retail store or only through the developer. In addition, when replacement samplers or spare parts were required during the demonstration, their availability was noted.

### 4.3 Field Sampling and Measurement Procedures

This section presents field sampling and measurement procedures used during the Split Core Sampler demonstration. Specifically, this section summarizes demonstration sampling locations; sample collection, sample preparation, and measurement procedures; and field QC procedures. Additional details about the sample collection, sample preparation, and measurement procedures are presented in the demonstration plan (EPA 1999). The demonstration plan is available on the Internet through the ORD web site (<http://www.epa.gov/ORD/SITE>).

Sediment samples were collected at Site 1 for PCB analysis, at Site 2 for arsenic analysis, and at both sites for PSD analysis. The sampling locations in each demonstration area are presented in Figures 4-1 and 4-2.

Table 4-2 lists the target sampling depth intervals, numbers of investigative samples, and analytical parameters for each demonstration area and provides the rationale for their selection. In general, the rationale for choosing the number of samples to be collected in each area was based on the objectives to be addressed, the analyses to be conducted to address one or more objectives, the time required to collect samples, and the cost of each analysis. When five samples were to be collected in a sampling area, samples were collected in the four corners and center of the area; when ten samples were collected in a sampling area, the additional five samples were collected at locations randomly distributed throughout the area.

Many of the field measurements made to support the primary objectives (see Section 4.2) were simple, standard measurements and do not require additional explanation. These measurements include the volume of IDW generated, number of sampling technicians, number of sampling attempts per location, volume of sediment collected, time required for sample collection activities, volume of fuel consumed to operate motorized sampling or support equipment, core length, sampling area grid size, and water velocity. However, several field measurements were made to address demonstration-specific requirements, and additional explanation of these measurements is warranted to enhance understanding of the sampler performance results presented in Chapters 6 and 7. These field measurements are summarized below by objective.

- To address primary objective P1, the volume of sediment sample from a given depth interval was measured, and then any unrepresentative material was removed from the sediment sample and collected as IDW. Unrepresentative material included sticks, shells, and stones. After removal of unrepresentative material, if not enough sediment was left to meet analytical sample volume requirements, the sampling technician collected additional cores from the sampling location.
- To address primary objective P2, the depth of sampler deployment was measured by allowing the sampling technician to lower the sampler to the surface of the sediment. Once the sampling technician felt that he had identified the sediment surface, a mark was made on the sampler cable or extension rod using a fixed

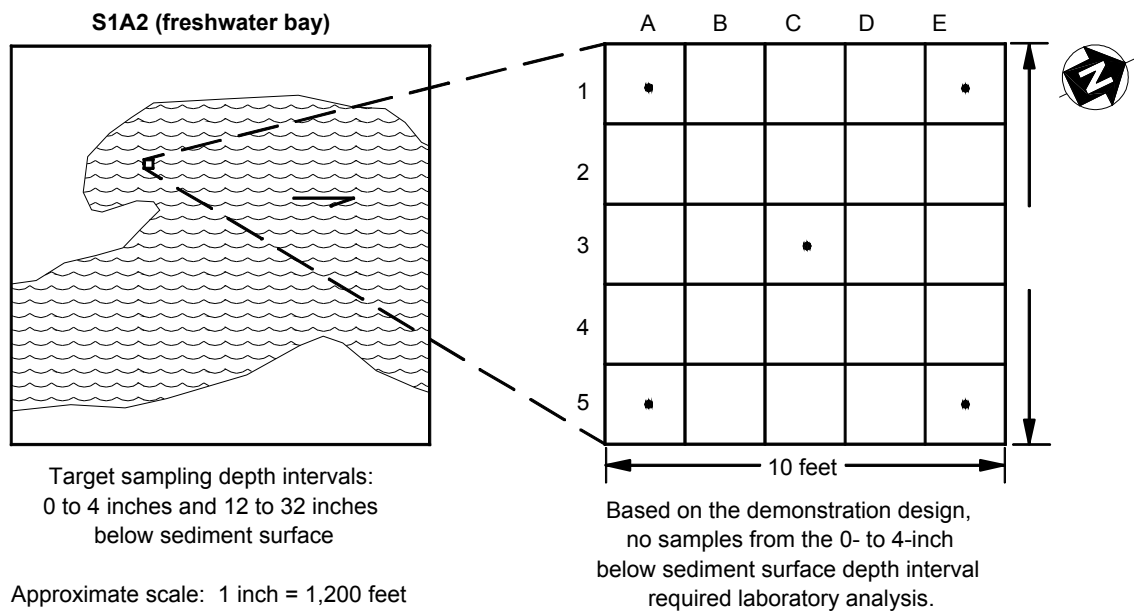
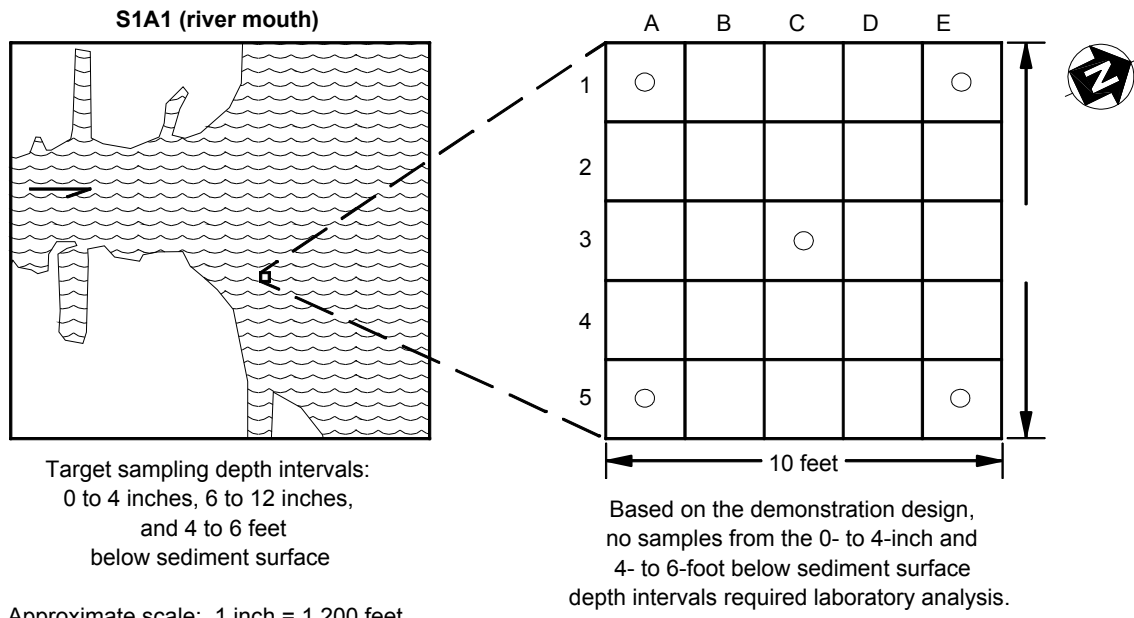

Legend	
○	Polychlorinated biphenyls
●	Particle size distribution
→	Flow direction

Figure 4-1. Site 1 sampling locations.

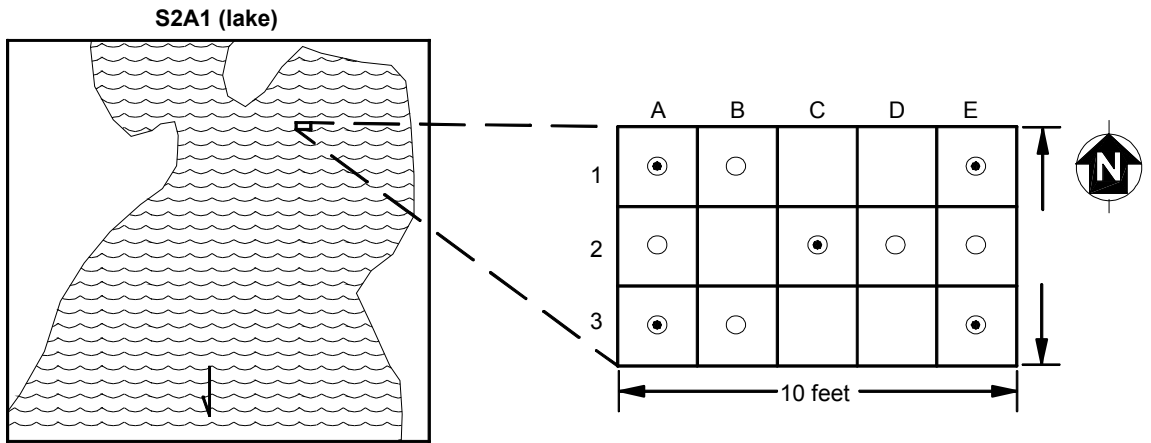

Target sampling depth intervals:  
0 to 4 inches and 10 to 30 inches  
below sediment surface

Approximate scale: 1 inch = 1,200 feet

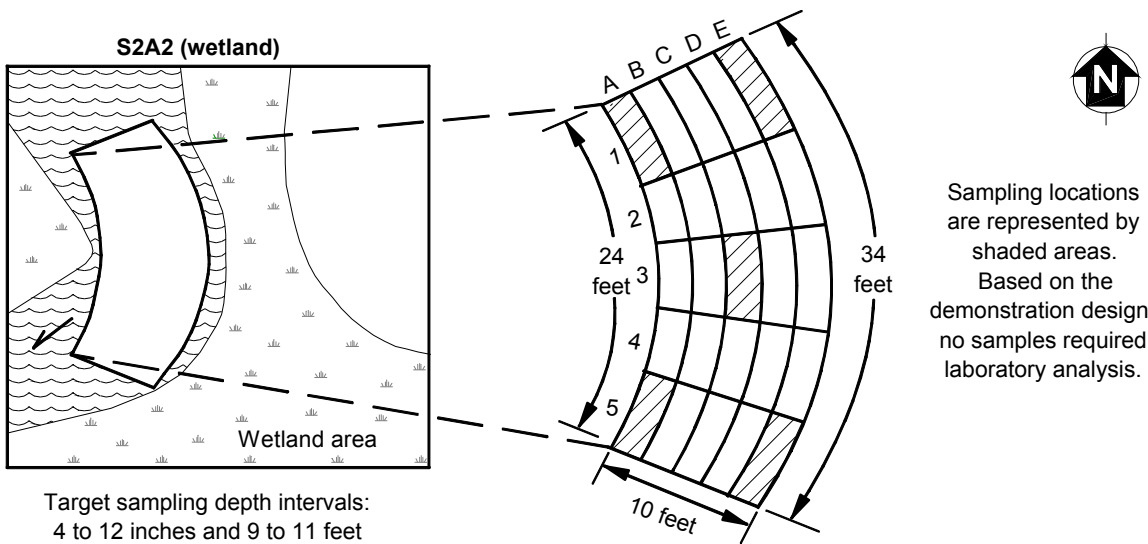

Target sampling depth intervals:  
4 to 12 inches and 9 to 11 feet  
below sediment surface

Approximate scale: 1 inch = 20 feet

Sampling locations are represented by shaded areas. Based on the demonstration design, no samples required laboratory analysis.

**Legend**

- Arsenic only
- Both arsenic and particle size distribution
- ← Flow direction

Figure 4-2. Site 2 sampling locations.



**Table 4-2. Rationale for Sampling Approach**

Demonstration Area	Target Sampling Depth Interval (bss)	Number of Investigative Samples per Sampler <sup>a</sup> (Analytical Parameter)	Matrix	Rationale
S1A1 (river mouth)	0 to 4 inches	5 (NA)	Sediment	Analytical samples not collected because only primary objectives P1 (volume), P2 (depth interval), and P6 (sample collection time) were addressed
	6 to 12 inches	5 (PCBs)	Sediment	Verify that contamination was present
		1 (PCBs)	Equipment rinsate	Determine whether a sampler could be adequately decontaminated (primary objective P5)
	4 to 6 feet	5 (NA)	Sediment	Analytical samples not collected because only primary objectives P1 (volume), P2 (depth interval), and P6 (sample collection time) were addressed
S1A2 (freshwater bay)	0 to 4 inches	5 (NA)	Sediment	Analytical samples not collected because only primary objectives P1 (volume), P2 (depth interval), and P6 (sample collection time) were addressed
	12 to 32 inches	5 (PSD)	Sediment	Determine whether a sampler could collect consistent samples from a homogenous layer of sediment (primary objective P3) with consistent physical characteristics
S2A1 (lake)	0 to 4 inches	10 (Arsenic) 5 (PSD)	Sediment	Determine whether a sampler could collect consistent samples from a homogenous layer of sediment (primary objective P3) with consistent physical and chemical characteristics and determine whether a sampler could collect sediment samples from a clean layer of sediment located below a layer of contaminated sediment (primary objective P4)
		1 (Arsenic)	Equipment rinsate	Determine whether a sampler could be adequately decontaminated (primary objective P5)
	10 to 30 inches	10 (Arsenic) 5 (PSD)	Sediment	Determine whether a sampler could collect consistent samples from a homogenous layer of sediment (primary objective P3) with consistent physical and chemical characteristics and determine whether a sampler could collect sediment samples from a clean layer of sediment located below a layer of contaminated sediment (primary objective P4)
S2A2 (wetland)	4 to 12 inches	5 (NA)	Sediment	Analytical samples not collected because only primary objectives P1 (volume), P2 (depth interval), and P6 (sample collection time) were addressed
	9 to 11 feet	5 (NA)	Sediment	

Notes:

- bss = Below sediment surface
- NA = Not applicable
- PCB = Polychlorinated biphenyl
- PSD = Particle size distribution

<sup>a</sup> The number of investigative samples varied depending on the analytical parameters and the objectives addressed in each demonstration area. Ten investigative samples were collected and analyzed for arsenic to address primary objectives P3 and P4. However, only five investigative samples were collected and analyzed for PSD to address primary objective P3 because the variability associated with PSD is typically less than that associated with arsenic concentrations.

reference point (the water surface, boat side, or boat floor). Another mark was made higher on the cable or extension rod indicating the depth corresponding to the sampling technician's estimate of the depth to which the sampler should be driven to collect a sediment sample from the specified sampling depth

interval. The sampler was then lowered to this depth,

and a sample was collected. For measurement of the total core length retrieved and the core length retrieved in the sampling depth interval, no correction was made for sample compression or expansion that might have taken place during sample collection.

- To address primary objectives P3 and P4, excess water overlying the sediment samples was carefully decanted before the samples were transferred to stainless-steel bowls and homogenized. The decanting step ensured that the sediment samples would have adequate percent solids for analysis. Homogenization involved stirring the material with a stainless-steel spoon for 4 minutes or longer until the sediment attained uniform color, texture, and residual water distribution. Sample containers were then filled using a quartering technique in which the homogenized sample present in the stainless-steel bowl was divided into quadrants. Each sample container was filled by using a spoon to alternately transfer sediment from one quadrant and then from the opposite quadrant until the sample container was filled. Any unused sediment was collected as IDW.
- To address primary objective P5, the nondisposable components of each sampler were decontaminated by scrubbing them with an Alconox solution, washing them with potable water, and then rinsing them with deionized water. At Site 1, 3 L of rinsate per sampler was generated to meet analytical and QC volume requirements for PCB analysis. At Site 2, 2 L of rinsate per sampler was generated to meet analytical and QC volume requirements for arsenic analysis. All deionized water used to generate rinsate samples was from one lot of water identified by a lot number. To verify that any contamination detected by the laboratory in the rinsate samples was not present in the deionized water or the result of field sample collection procedures at Sites 1 and 2, samples of this water were sent to the laboratory for PCB and arsenic analyses, respectively, along with the rinsate samples. Deionized water samples were collected once at each demonstration site during collection of sediment samples.
- To address primary objective P6, timing of sampler setup began when a sampling technician began assembling a given sampler and ended when the sampler was completely assembled and any additional equipment necessary for sampling using the sampler

had been collected and was ready to be transported to the sampling location. If additional time was required to set up the sampler at the sampling location, this time was measured and included in the total setup time.

Timing of sample collection began when the sampler was ready to be deployed and ended when the sample had been retrieved; extruded from the sampler; and submitted for measurement, preparation, and distribution into the appropriate containers for analysis. If additional sampling attempts were required to collect the specified sample volume, the time required to complete these attempts was added to the sample collection time. If any portion of the sampler was disassembled to extrude a sample and reassembled before the next sample was collected, the time required for disassembly and reassembly was included in the total sample collection time. Between sampling attempts and locations, if a sampler had any sediment adhering to it, the sampler was rinsed at the sampling location using surface water. The time required for rinsing was also added to the total sample collection time. Sample collection time did not include the time needed to position the sampling platforms at specific sampling locations.

Timing of sampler disassembly began when all samples had been collected or extruded and the sampling technician began disassembly of the sampler. The timing ended when the sampler had been completely disassembled and was ready to be decontaminated.

Timing of sampler decontamination began when the nondisposable components of each sampler were decontaminated by scrubbing them with an Alconox solution. The timing continued until the sampling technician considered the sampler to be decontaminated to the degree that a sample of the final rinsate could be collected to address primary objective P5. Sampler decontamination occurred once in each demonstration area after all samples were collected and the sampler was disassembled.

QC checks for field measurements were used to evaluate the quality of field activities. In general, the QC checks were used to assess the representativeness of the samples and to ensure that the degree to which the analytical data were representative of actual site conditions was known

and documented. QC checks for field parameters consisted of the time required for sample collection activities and the water velocity. Field QC checks for laboratory parameters consisted of temperature blanks (in shipments that contained samples for PCB analysis) and field replicates. Field replicates were collected to evaluate whether a sample was adequately homogenized in the field prior to filling of sample containers. Field replicate samples included field duplicates (rinsate) for PCB and arsenic analyses and field triplicates (sediment) for PCB, arsenic, and PSD analyses. Table 4-3 identifies the planned numbers of investigative samples and field replicate samples. Field replicate samples were submitted for laboratory analysis as blind samples (that is, the laboratories did not know which samples were replicates). Acceptance criteria and associated corrective actions for field QC checks are presented in the demonstration plan (EPA 1999).

During the demonstration, the EPA conducted an internal technical system audit (TSA) of field sampling and measurement systems. The following activities were audited during the field TSA: sample collection; sample preparation; field measurements; field documentation; decontamination; and sample labeling, packaging, and shipping.

A summary discussion of whether the field QC procedures generated data that met the demonstration objectives is presented in Sections 6.3 and 7.3 for the innovative and reference samplers, respectively. More detailed information is provided in the DER (Tetra Tech EM Inc. [Tetra Tech] 1999b).

#### **4.4 Laboratory Sample Preparation and Analysis Methods**

In selecting appropriate methods for preparing and analyzing the demonstration samples from Sites 1 and 2, the specific analytes of interest, the laboratories' experience in analyzing the predemonstration samples, and the target reporting limits required to address the demonstration objectives were taken into account. Table 4-4 summarizes the laboratory sample preparation and analysis methods used for the demonstration.

Laboratory QC checks were used to demonstrate the absence of interferants and contamination from laboratory glassware and reagents, to verify that the measurement systems were in control, to evaluate the precision and accuracy of laboratory analyses, and to ensure the comparability of data. Laboratory-based QC checks other than those associated with instrument calibration consisted of method blanks, surrogates, MS/MSDs, extract and digestate duplicates, blank spike/blank spike duplicates (BS/BSD), interference check analyses, serial dilutions, postdigestion spikes, repeat analyses, and performance evaluation (PE) samples. Table 4-5 summarizes the laboratory QC checks used for the demonstration and their purpose. The frequencies, acceptance criteria, and corrective actions for QC checks are presented in the demonstration plan (EPA 1999).

Predemonstration and in-process TSAs of the laboratories used for the demonstration were conducted. The following activities were audited: sample receipt and sample storage; internal chain of custody; sample extraction, digestion, and cleanup; sample analysis; standards preparation and storage; calibration; QC procedures; and data reduction, validation, and reporting.

Predemonstration and in-process performance audits of laboratory activities were also conducted for PCB and arsenic analyses. During each audit, (1) two PE samples (one low-level and one high-level) each for PCBs and arsenic were obtained for the sediment matrix and (2) one low-level PE sample each for PCBs and arsenic was obtained for the aqueous matrix. The PE samples were submitted to the laboratory as double-blind samples for analysis.

A summary discussion of whether the laboratory QC procedures generated data that met the demonstration objectives is presented in Sections 6.3 and 7.3 for the innovative and reference samplers, respectively. More detailed information is provided in the DER (Tetra Tech 1999b).

**Table 4-3. Sample Matrix**

Demonstration Area	Target Sampling Depth Interval (bss)	Sampler	Analytical Parameter	Sediment Samples					Equipment Rinsate Samples			
				Number Per Sampler				Total Number of Analyses	Number Per Sampler			Total Number of Analyses
				Investigative Samples	MS/MSD Samples <sup>a</sup>	Field Triplicate Samples <sup>b</sup>	Laboratory Analyses		Equipment Rinsate Samples	Field Duplicate Samples <sup>c</sup>	Laboratory Analyses	
S1A1 (river mouth)	0 to 4 inches	Split Core Sampler Vibrocorer	NA	5	Samples were not analyzed for PCBs, arsenic, or PSD. The rationale for the number of samples is provided in Table 4-2.							
	6 to 12 inches	Split Core Sampler Vibrocorer	PCBs	5	1	2	11	22	1	1	2	4
	4 to 6 feet	Dual Tube Liner Sampler Vibrocorer	NA	5	Samples were not analyzed for PCBs, arsenic, or PSD. The rationale for the number of samples is provided in Table 4-2.							
S1A2 (freshwater bay)	0 to 4 inches	Split Core Sampler Hand Corer	NA	5	Samples were not analyzed for PCBs, arsenic, or PSD. The rationale for the number of samples is provided in Table 4-2.							
	12 to 32 inches	Split Core Sampler Hand Corer	PSD	5	NA	1	7	14	NA	NA	0	0
S2A1 (lake)	0 to 4 inches	Split Core Sampler Hand Corer	Arsenic	10	2	3	20	40	1	1	2	4
			PSD	5	NA	1	7	14	NA	NA	0	0
	10 to 30 inches	Split Core Sampler Hand Corer	Arsenic	10	2	3	20	40	0	0	0	0
			PSD	5	NA	1	7	14	NA	NA	0	0
S2A2 (wetland)	4 to 12 inches	Split Core Sampler Hand Corer	NA	5	Samples were not analyzed for PCBs, arsenic, or PSD. The rationale for the number of samples is provided in Table 4-2.							
	9 to 11 feet	Dual Tube Liner Sampler	NA	5	Samples were not analyzed for PCBs, arsenic, or PSD. The rationale for the number of samples is provided in Table 4-2.							

Notes:

bss = Below sediment surface      NA = Not applicable      PSD = Particle size distribution  
 MS/MSD = Matrix spike/matrix spike duplicate      PCB = Polychlorinated biphenyl

- <sup>a</sup> MS/MSD samples were collected for PCB and arsenic analyses and were designated in the field. MS/MSD samples were not collected for equipment rinsate samples because the additional volume required for the analysis may have diluted any contamination present to concentrations below laboratory detection limits. Sediment MS/MSD samples did not require additional sample volume.
- <sup>b</sup> Field triplicate sediment samples were collected by filling three sample containers with homogenized sediment. A sufficient volume of sediment for field triplicate samples was collected as described in the approach for addressing primary objective P1 in Section 4.2. Field triplicate samples were submitted for analysis as blind samples.
- <sup>c</sup> Field duplicate equipment rinsate samples were collected by filling one additional container for PCB or arsenic analysis. Field duplicate samples were submitted for analysis as blind samples.

**Table 4-4. Laboratory Sample Preparation and Analysis Methods**

Parameter (Matrix)	Method Reference <sup>a</sup>	Method Title
PCBs (sediment)	SW-846 Method 3550B (extraction)	Ultrasonic Extraction
	SW-846 Method 3665A <sup>b</sup> (cleanup)	Sulfuric Acid/Permanganate Cleanup
	SW-846 Method 3660B <sup>c</sup> (cleanup)	Sulfur Cleanup
	SW-846 Method 8082 (analysis)	PCBs by Gas Chromatography
PCBs (equipment rinsate)	SW-846 Method 3510C (extraction)	Separatory Funnel Liquid Extraction
	SW-846 Method 3665A <sup>b</sup> (cleanup)	Sulfuric Acid/Permanganate Cleanup
	SW-846 Method 8082 (analysis)	PCBs by Gas Chromatography
Arsenic (sediment)	SW-846 Method 3050B (digestion)	Acid Digestion of Sediment, Sludges, and Soils
	SW-846 Method 6010B (analysis)	Inductively Coupled Plasma-Atomic Emission Spectrometry
Arsenic (equipment rinsate)	SW-846 Method 3010A (extraction)	Acid Digestion of Aqueous Samples and Extracts for Total Metals for Analysis by FLAA or ICP Spectroscopy
	SW-846 Method 6010B (analysis)	Inductively Coupled Plasma-Atomic Emission Spectrometry
PSD (sediment)	ASTM Method D 422-63 (Reapproved in 1990)	Standard Method for Particle-Size Analysis of Soils (with hydrometer option)

Notes:

- ASTM = American Society for Testing and Materials
- EPA = U.S. Environmental Protection Agency
- FLAA = Flame atomic absorption
- ICP = Inductively coupled argon plasma
- PCB = Polychlorinated biphenyl
- PSD = Particle size distribution

<sup>a</sup> SW-846 reference: EPA 1996; ASTM reference: ASTM 1998

<sup>b</sup> SW-846 Method 3665A is used whenever elevated baselines or overly complex chromatograms prevent accurate quantitation of Aroclors. The laboratory routinely performed sulfuric acid cleanup on PCB sample extracts using SW-846 Method 3665A.

<sup>c</sup> The laboratory detected elevated levels of sulfur in predemonstration investigation samples analyzed for PCBs. Therefore, the laboratory monitored PCB chromatograms for the presence of sulfur and cleaned up the extracts using SW-846 Method 3660B when sulfur was detected.

**Table 4-5. Laboratory Quality Control Checks**

Quality Control Check	Parameter	Matrix	Purpose
Method blanks	PCBs and arsenic	Sediment and rinsate	Verify that steps in the analytical procedures did not introduce contaminants that affected analytical results
Surrogates	PCBs	Sediment and rinsate	Determine whether significant matrix effects existed within the samples and measure the efficiency of recovery of analytes in sample preparation and analysis
MS/MSDs <sup>a</sup>	PCBs and arsenic	Sediment	Determine the accuracy and precision of the analytical results with respect to the effects of the sample matrix
Extract duplicates	PCBs	Sediment and rinsate	Determine the precision associated with laboratory analytical procedures following sample extraction
Digestate duplicates	Arsenic	Sediment and rinsate	Determine the precision associated with laboratory analytical procedures following sample digestion
BS/BSDs	PCBs and arsenic	Sediment and rinsate	Determine whether observed deviations for MS/MSDs and for extract and digestate duplicate samples were caused by a matrix effect
Interference check analyses	Arsenic	Sediment and rinsate	Evaluate the validity of the interelement correction factors
Serial dilutions	Arsenic	Sediment and rinsate	Determine whether significant physical or chemical interferences existed as a result of the sample matrix
Postdigestion spikes	Arsenic	Sediment and rinsate	Determine whether a matrix effect should be expected
Repeat analyses	PSD	Sediment	Evaluate the precision of hydrometer readings
PE samples	PCBs and arsenic	Sediment and water	Determine the accuracy associated with the laboratory analytical procedures for low-level and high-level concentrations

Notes:

- BS/BSD = Blank spike/blank spike duplicate
- MS/MSD = Matrix spike/matrix spike duplicate
- PCB = Polychlorinated biphenyl
- PE = Performance evaluation
- PSD = Particle size distribution

<sup>a</sup> MS/MSD samples were not collected for equipment rinsate samples because the additional volume required for the analysis may have diluted any contamination present to concentrations below laboratory detection limits. In addition, MS/MSDs are not typically collected for rinsate samples.

---

## Chapter 5

### Description of the Reference Sediment Samplers

This chapter describes two conventional sediment samplers that were used as reference samplers during the demonstration. Each reference sampler was chosen based on its proven ability to meet the various demonstration objectives presented in Section 4.1. Specifically, two core samplers were selected as reference samplers: the Hand Corer and the Vibrocorer.

The Hand Corer is a commonly used core sampler designed to obtain sediment samples in a variety of lake and river environments. The sampler can collect continuous sediment cores to a depth of about 36 inches bss. Based on the predemonstration investigation results, demonstration objectives, and site support facilities available, the Hand Corer was selected as the reference sampler for S1A2, S2A1, and S2A2.

The Vibrocorer is a core sampler designed to obtain sediment samples in a variety of shallow and deep river, lake, and ocean environments. The sampler has been successfully used by the EPA at several contaminated sites in Region 5. Based on the predemonstration investigation results, demonstration objectives, and site support facilities available, the Vibrocorer was selected as the reference sampler for S1A1.

Sections 5.1 and 5.2 provide descriptions, discuss general operating procedures, and outline advantages and limitations of the Hand Corer and Vibrocorer used in the demonstration.

#### 5.1 Hand Corer

The Hand Corer selected as a reference sampler for the demonstration is designed to collect undisturbed,

cylindrical core samples from various types of sediment, including saturated sands and silts, to a depth of about 36 inches bss in stagnant or swiftly moving water.

##### 5.1.1 Technology Description

Components of the Hand Corer include (1) a Lexan™ nose piece; (2) a 36-inch-long, stainless-steel core tube; (3) a stainless-steel head piece with a flutter valve; (4) two detachable, stainless-steel handles; and (5) a clevis (see Figure 5-1). For deployment in deep water, the Hand Corer can be equipped with a guide rope or extension rods and a turning handle. The Hand Corer can also be equipped with disposable, clear plastic core tube liners that fit inside the core tube (these liners are not shown in Figure 5-1).

Support equipment for sampler deployment may include a tripod-mounted winch for (1) controlling the rate of sampler deployment and retrieval; (2) minimizing the physical stress on the sampling technician, particularly during sampler retrieval and during intense or extended sampling events; and (3) preventing the sampler from sinking too deeply into the sediment to obtain a representative sample.

The stainless-steel core tube has a 2-inch outside diameter and is designed to collect about 50 mL of sediment per inch of core tube length; the maximum design volume of the core tube is about 1,800 mL. The fully equipped Hand Corer, including the nose piece, core tube, head piece with flutter valve, handles, and clevis, weighs about 12 lb. Each 5-foot-long extension rod and a turning handle weigh about 5 and 2 lb, respectively.

In water less than 20 feet deep, the Hand Corer may be manually deployed and driven into the sediment using the

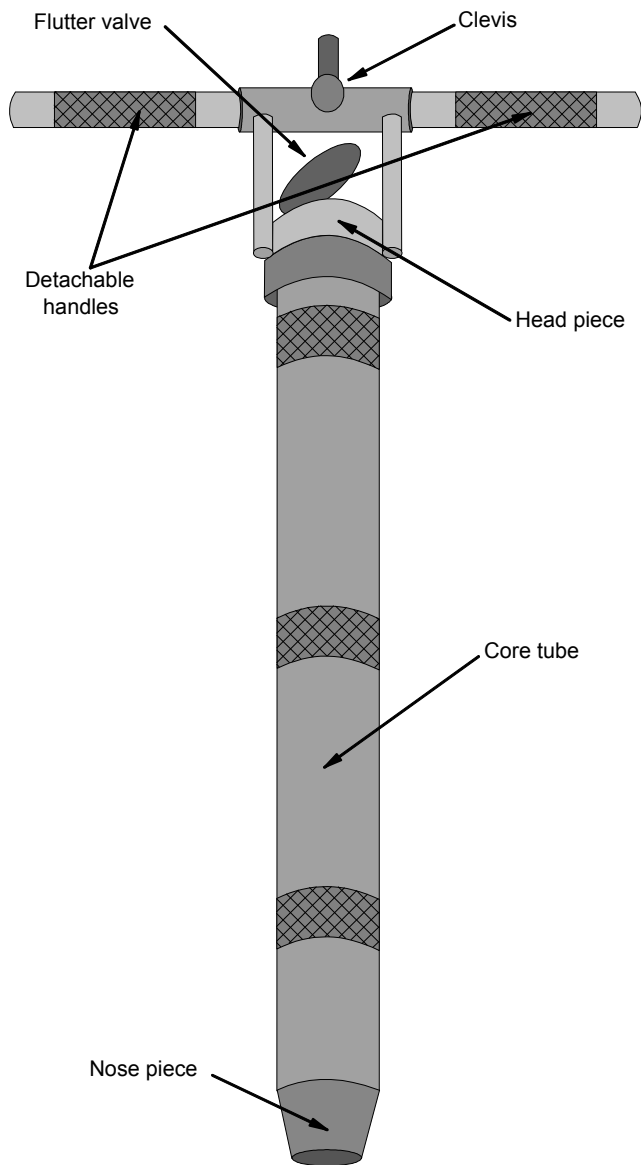

Figure 5-1. Hand Corer.

handles and the necessary length of extension rods. In water more than 20 feet deep, the sampler may be deployed using a guide rope attached to the clevis and a weight attached to the core tube. During sampler retrieval, a sediment core is retained within the core tube by a partial vacuum created by the closed flutter valve.

### 5.1.2 General Operating Procedures

The Hand Corer can be operated in shallow water by one person from a platform, from a boat, or while wading. For

sampling in deep water, two sampling technicians are recommended to control the weight of the sampler and extension rods and to conduct efficient sampling. During sampler assembly, a plastic core tube liner may be inserted into the core tube. Core tube liners hold and store the sample for later examination. Depending on the water depth and flow conditions, either the handles and the necessary number of extension rods or the guide rope can be used to deploy the Hand Corer to the sediment surface. The speed of sampler deployment to the sediment surface should be controlled to avoid bow wave formation, which could disturb flocculent or unconsolidated sediment that might be near the sediment surface (Blomqvist 1991).

The sampler may be driven into the sediment by manual force on the handles or by gravity penetration. In general, the sampler should be driven into the sediment in a steady and uninterrupted manner. The sampler is manually retrieved by pulling upward on the handles, extension rods, or guide rope, as appropriate. When samples are being collected in shallow water depths, the flutter valve should be manually closed once the Hand Corer reaches the desired sediment depth. When the sampler is being retrieved from deep water depths, the upward motion of the submerged sampler causes the flutter valve to automatically close. The tapered nose piece and partial vacuum created by the flutter valve retain the sediment core within the plastic core tube liner. When the weight of the sampler and extension rods requires it, a tripod-mounted winch should be used to control the rate of sampler retrieval. The sampler should be kept vertical and the rate of retrieval should be kept as steady as possible to minimize resuspension and disruption of the sediment.

After sampler retrieval, the nose piece or head piece is removed to allow removal of the plastic core tube liner. The sediment core enclosed in the core tube liner may be either sealed in the core tube using two core caps or extruded for further examination and processing. The sediment core may be removed by pushing the sample out one end of the core tube liner with an extrusion rod. Prior to sampling, some sampling technicians cut the core tube liner twice longitudinally and tape the liner together with vinyl electrical tape before inserting the liner into the core tube. In this case, after a sample is collected, the tape holding the two halves of the core tube liner is cut, splitting the liner in half and exposing the sediment core.



### 5.1.3 *Advantages and Limitations*

An advantage of the Hand Corer is that it is easy to operate, requiring minimal skills and training. Sampler assembly and sample collection procedures can be learned in the field with a few practice attempts. In addition, a written SOP typically accompanies the sampler when it is procured. The sampler can be operated by one person in shallow (wading) water depths because of its light weight (12 lb). Sampler operation is especially simple when a core tube liner is used because the sampler does not require complete disassembly to extrude the sample and reassembly after each sampling attempt. Only the nose piece or head piece requires detachment to remove the plastic core tube liner containing the sediment core. Use of the disposable liner also minimizes the risk of cross-contamination between sampling locations.

Another advantage of the Hand Corer is the flutter valve in the head piece. The flutter valve is designed to allow water to exit the top of the core tube during sampler deployment, thus minimizing potential bow wave formation near the sediment surface. During sampler retrieval, the sediment core is retained within the core tube by a partial vacuum created by the closed flutter valve. Collectively, these design features increase the likelihood of collecting an undisturbed sample.

A limitation of the Hand Corer is that during sampler deployment, the plastic core tube liner is exposed to different layers of sediment contamination. Contaminants may adhere to the exposed surface of the liner while the sampler passes through different layers of sediment. Also, the flutter valve may become clogged if the sampler is deployed in such a way that the flutter valve is driven into the sediment. Specifically, sediment and nonsedimentaceous materials (leaves, plant roots, or small stones) may become trapped between the flutter valve and core tube, resulting in partial or complete loss of vacuum and eventually partial or complete loss of the sediment sample.

Another limitation of the Hand Corer is that it cannot collect discrete samples from various sediment depths. Core samples must be collected from the sediment surface downward. Because end-filling samplers such as the Hand Corer must collect samples from the sediment surface downward, the Hand Corer is subject to core shortening. Core shortening occurs when the length of sediment core

collected is less than the depth of sampler penetration into the sediment. Core shortening may occur when the friction of the sediment against the inside wall of the core tube increases with increasing depth of sediment penetration, causing lateral displacement of sediment and resulting in gradually thinner increments of sediment entering the sampler. Because not all layers are uniformly sampled, core shortening can introduce sampling bias.

Furthermore, use of a tripod-mounted winch limits the sampling platform locations from which the sampler can be deployed. Specifically, the sampling platform must be equipped with a hole over which the tripod-mounted winch can be placed and through which the sampler can be deployed.

## 5.2 **Vibrocorer**

The Vibrocorer is designed to collect sediment cores in deep river, lake, and ocean environments. The sampler is designed to operate in shallow and deep water conditions and to provide complete and continuous sediment profile collection to a maximum depth of 4,000 feet beneath the water surface. According to the EPA GLNPO, the sampler is designed to collect sediment cores to a depth of 15 feet bss in packed sand and to a depth of 20 feet bss in silt and clay; however, sediment cores have been successfully collected to a depth of 35 feet bss using the Vibrocorer.

### 5.2.1 *Technology Description*

Components of the Vibrocorer include (1) an anodized-aluminum, pressure-housed vibrohead with a terminal for an electric cable; (2) a disposable, 10-foot-long, 4-inch-diameter, clear plastic core tube; (3) a core tube clamp; and (4) a guide rope (see Figure 5-2). The sampler is also equipped with a check valve in the vibrohead and a core nose at the bottom end of the core tube (the check valve and core nose are not shown in Figure 5-2). Core tube sectioning and extraction are performed using a hand-held or battery-powered electric saw. The Vibrocorer requires a three-phase, 230- or 440-volt, 50- to 60-hertz electric current. The sampler must be supplied with power from a power source through an electric cable and a control box. The Vibrocorer must be operated from a boat, dock, or platform with enough working space to accommodate an A-frame of adequate size.

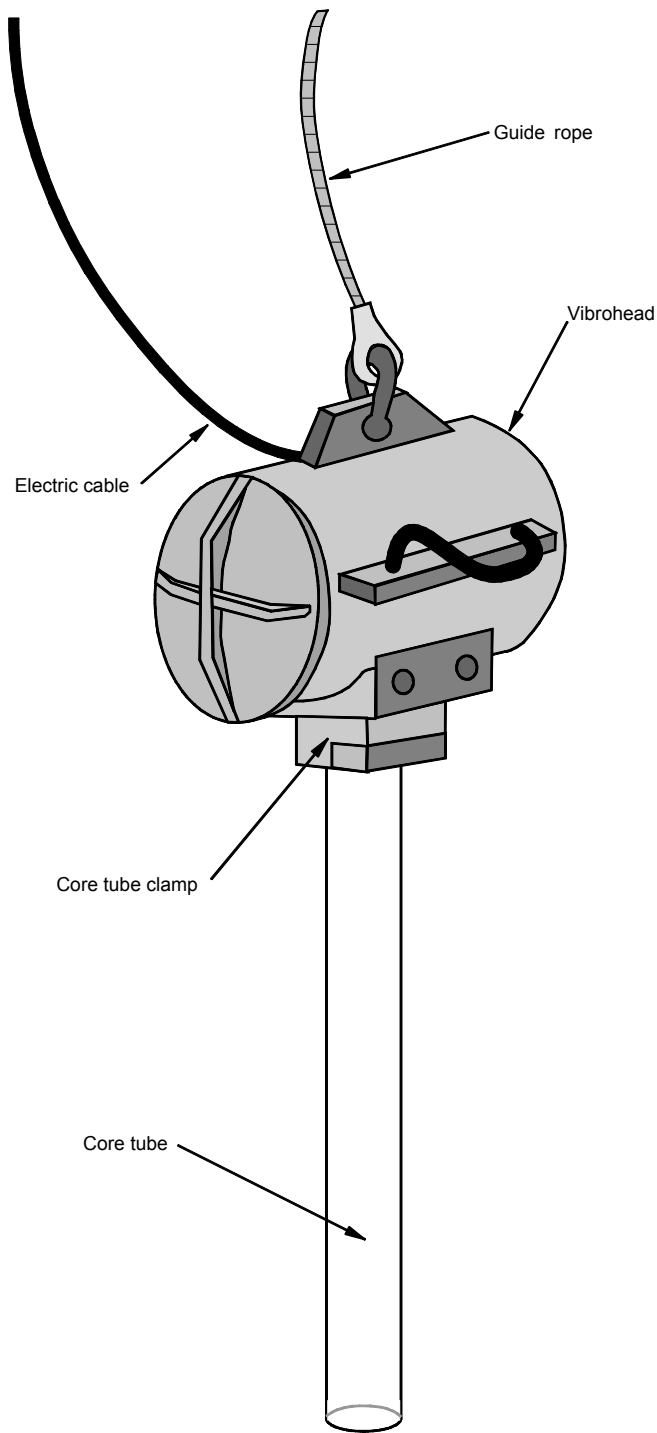

Figure 5-2. Vibrocorer.

The typical weight of a fully equipped Vibrocorer, including the vibrohead and core tube, is about 150 lb. Core tubes are available in lengths up to 15 feet with a 4-inch diameter and up to 20 feet with a 3-inch diameter.

If a 15-foot-long core sample is required, the core tube must be 16 feet long because 6 inches is lost when the core tube is inserted into the vibrohead and 6 inches is lost when the core nose is attached.

The Vibrocorer is deployed to the sediment surface using the A-frame and winch. Once the sampler is deployed to the sediment surface and supplied with power, the vibrohead vibrates at a frequency of up to 3,450 vibrations per minute, depending on the power supply. The vibrating motion of the vibrohead drives the core tube vertically downward into the sediment. The sampler is retrieved mechanically using the A-frame and winch. During sampler retrieval, the check valve in the vibrohead creates a vacuum that, along with the core nose, retains sediment within the core tube.

### 5.2.2 General Operating Procedures

The Vibrocorer must be operated by at least two persons from a boat, dock, or platform. To prepare for sampler deployment, the vibrohead is raised using the A-frame and winch, and the core tube is secured to the vibrohead at the core tube clamp. Again using the A-frame and winch, the sampler is deployed to the desired sampling position; the vibrohead should then be supplied with power and allowed to vibrate. The speed of sampler deployment to the sediment surface should be controlled to avoid bow wave formation, which could disturb flocculent or unconsolidated sediment that might be near the sediment surface (Blomqvist 1991).

As the vibrohead vibrates, the core tube is gradually forced downward into the sediment. Once the core tube is deployed to the desired sediment depth, the power can be turned off and the vibrohead can be allowed to stop vibrating. Now the sampler can be mechanically removed from the sediment using the A-frame and winch. During sampler retrieval, the check valve in the vibrohead creates a vacuum that, along with the core nose, retains sediment within the core tube. Once the core tube is retrieved from the water, water remaining in the top of the core tube should be drained by drilling holes in the core tube at the sediment-water interface with an electric or battery-powered drill. To remove the core tube from the core tube clamp, four nuts that secure the core tube in place must be removed. Afterward, the core tube is placed on the sampling platform to extract the sediment. To extract the core sample, horizontal sections of the core tube should be cut using an electric or battery-powered saw.

### 5.2.3 *Advantages and Limitations*

Advantages of the Vibrocorer include its ability to collect sediment samples up to 4,000 feet beneath the water surface. In addition, the vibrohead component of the sampler allows core tube penetration into the sediment without manual labor. Sampler deployment and retrieval are controlled with an A-frame and winch. Furthermore, use of new core tubes for each sampling attempt minimizes the risk of cross-contamination between sampling locations.

A limitation of the Vibrocorer is that during sampler deployment, the disposable core tube is exposed to different layers of sediment contamination. Contaminants may adhere to the exposed surface of the core tube while

the sampler passes through different layers of sediment. In addition, the sampler cannot collect discrete samples from various sediment depths; core samples must be collected from the sediment surface downward. As a result, samples collected with the Vibrocorer are subject to core shortening as described in Section 5.1.3.

Another limitation of the Vibrocorer is that it must be operated by at least two persons from a boat, dock, or platform. If the sampler is being operated from a boat and the boat drifts away from the deployed Vibrocorer, the tension on the winch cable could pull the Vibrocorer over and damage it, or the electric cable could snap and cause an electrical short circuit. Also, if the boat drifts while the Vibrocorer is deployed, extracting the core tube from the sediment would be difficult because the winch cable from the sampler to the boat would not be vertical; as a result, the core tube could be bent and the sediment sample could be lost.

## Chapter 6

### Performance of the Split Core Sampler

To verify a wide range of performance attributes, the innovative sediment sampler demonstration had both primary and secondary objectives. Primary objectives were critical to the technology evaluation and were intended to produce quantitative results regarding technology performance. Secondary objectives provided information that was useful but did not necessarily produce quantitative results regarding technology performance. The approach used to address each primary and secondary objective for the Split Core Sampler and reference samplers is discussed in Chapter 4. This chapter describes the performance of the Split Core Sampler based on the primary objectives (excluding costs associated with sample collection activities) and secondary objectives. This chapter also discusses the data quality of demonstration results for the Split Core Sampler.

The performance of the reference samplers is discussed in Chapter 7, costs associated with sample collection activities (primary objective P7) are presented in Chapter 8, and the performance of the Split Core Sampler and reference samplers is compared in summary form in Chapter 9.

#### 6.1 Primary Objectives

This section discusses the performance results for the Split Core Sampler based on the primary objectives stated in Section 4.1 except for primary objective P7 (sampling costs), which is addressed in Chapter 8. Primary objectives P1 through P6 required evaluation of the Split Core Sampler's

P1. Ability to consistently collect a specified volume of sediment

P2. Ability to consistently collect sediment in a specified depth interval

P3. Ability to collect multiple samples with consistent physical or chemical characteristics, or both, from a homogenous layer of sediment

P4. Ability to collect a representative sample from a clean sediment layer below a contaminated sediment layer

P5. Ability to be adequately decontaminated

P6. Time requirements for sample collection activities

To address primary objectives P1 through P6, samples were collected from four different areas: (1) S1A1, a river mouth; (2) S1A2, a small, freshwater bay; (3) S2A1, a lake; and (4) S2A2, a wetland. A sampling technician designated by AMS used the Split Core Sampler to collect samples from the following target depth intervals: 0 to 4 and 6 to 12 inches bss in S1A1, 0 to 4 and 12 to 32 inches bss in S1A2, 0 to 4 and 10 to 30 inches bss in S2A1, and 4 to 12 inches bss in S2A2. Multiple depth intervals were simultaneously sampled in a given attempt if the sampler was long enough to reach these intervals. For example, in S2A1, sediment samples were simultaneously collected in the 0- to 4- and 10- to 30-inch bss depth intervals until sample volume requirements were met for the 10- to 30-inch bss depth interval. If additional sample volume was still needed for the 0- to 4-inch bss depth interval, additional sampling attempts were made in only that depth interval. Because the Split Core Sampler is not designed to collect samples at a depth below 4 feet bss, the sampler was not used in the 4- to 6-foot bss depth interval in S1A1 or in the 9- to 11-foot bss depth interval in S2A2. The demonstration areas and target depth

intervals are described in greater detail in Chapters 3 and 4. The numbers of investigative and QC samples collected in each demonstration area, sediment sample volumes required, and sample analytical parameters are discussed in Chapter 4.

During the demonstration, AMS used two different Split Core Sampler core tube lengths to collect sediment samples: 6 and 12 inches. The Split Core Samplers were configured by screwing together the appropriate number of 6- and 12-inch-long core tubes to achieve the desired core tube length for a given sampling scenario. Both the 6- and 12-inch-long core tubes had a 2-inch inside diameter. AMS chose which core tubes to use based on site and area conditions and sampling requirements identified in the demonstration plan. The sampling technician was also provided an opportunity to practice sample collection at each demonstration until he felt confident enough to initiate demonstration sampling. The Split Core Sampler is described in Chapter 2.

The demonstration results for the Split Core Sampler under primary objectives P1, P2, and P4 were evaluated using the Wilk-Shapiro test to determine whether the results were normally distributed. Because most of the results were not normally distributed, the Wilk-Shapiro test was used in an attempt to evaluate whether the results followed a lognormal distribution. The test revealed that the results either were not lognormally distributed or could not be tested for lognormality because they contained values that were equal to zero. For these reasons, a parametric test such as the paired Student's t-test was not used to perform hypothesis testing. The Wilcoxon signed rank test, a nonparametric test for paired samples that makes no assumptions regarding distribution, was used as an alternative to the Student's t-test. Although the Wilcoxon signed rank test has been historically accepted as a nonparametric test, it is not as powerful as the Student's t-test because the Wilcoxon signed rank test does not account for the magnitude of difference between sample pair results. Despite this limitation, the Wilcoxon signed rank test was more appropriate than the Student's t-test for evaluating the demonstration results. A computer program known as Statistix<sup>®</sup> for Windows, Version 2.0 (Statistix<sup>®</sup>) developed by Analytical Software of Tallahassee, Florida, was used to perform statistical evaluations of the demonstration results (Analytical Software 1996). Appendix C provides details on the statistical methods used for data evaluation.

### **6.1.1 Ability to Consistently Collect a Specified Volume of Sediment**

Primary objective P1 involved evaluating the Split Core Sampler's ability to consistently collect a specified volume of sediment. This objective was addressed by comparing (1) the actual number of sampling attempts required to collect a specified volume of sediment to the expected number of attempts (rounded to the nearest higher integer) at each sampling location in each target depth interval and (2) the actual volume of sediment collected in the specified target depth interval in each attempt to the calculated sampler volume (design volume) for the depth interval. The expected number of attempts was determined by dividing the specified sample volume by the design volume for the depth interval. The results of these comparisons are summarized below.

#### **6.1.1.1 Number of Sampling Attempts Required**

Tables 6-1 and 6-2 present the expected and actual number of sampling attempts for each depth interval at Sites 1 and 2, respectively. Initially, the Wilcoxon signed rank test was used to determine whether the difference between the expected and actual number of attempts was statistically significant. However, the conclusions drawn from the Wilcoxon signed rank test were inconsistent with the conclusions reached in comparing the expected and actual number of attempts. This discrepancy was primarily due to the test's inability to account for the magnitude of the difference between data pairs (see Appendix C for an example).

Based on the number of sampling attempts required in S1A1, the Split Core Sampler performed well in the 0- to 4- and 6- to 12-inch bss depth intervals, where the expected number of attempts equaled the actual number of attempts.

The Split Core Sampler's performance in S1A2 was similar to that in S1A1. One additional attempt was required in the 12- to 32-inch bss depth interval at one of the five sampling locations in S1A2.

In S2A1, which was the first area sampled during the demonstration, the Split Core Sampler performed well in the 0-to 4-inch bss depth interval but did not perform well in the 10- to 30-inch bss depth interval. In the 0- to 4-inch bss depth interval, the Split Core Sampler required

**Table 6-1. Comparison of Expected and Actual Number of Sampling Attempts for Split Core Sampler at Site 1**

Location	Number of Attempts in S1A1 (River Mouth)			
	0- to 4-Inch bss Depth Interval		6- to 12-Inch bss Depth Interval	
	Expected	Actual	Expected	Actual
1A	1	1	1	1
1E	1	1	3	3
3C	1	1	1	1
5A	1	1	3	3
5E	1	1	1	1
Total	5	5	9	9

Location	Number of Attempts in S1A2 (Freshwater Bay)			
	0- to 4-Inch bss Depth Interval		12- to 32-Inch bss Depth Interval	
	Expected	Actual	Expected	Actual
1A	1	1	1	1
1E	1	1	1	1
3C	1	1	1	1
5A	1	1	1	2
5E	1	1	1	1
Total	5	5	5	6

Note:

bss = Below sediment surface

36 attempts, whereas 33 attempts were expected. Specifically, one additional attempt was required in the 0- to 4-inch bss depth interval at three of the ten sampling locations. In the 10- to 30-inch bss depth interval, the Split Core Sampler required 20 attempts, whereas 10 attempts were expected. However, the actual number of attempts exceeded the expected number of attempts by more than one attempt at only three of the ten sampling locations. For the 10- to 30-inch bss depth interval at four of the ten locations, one attempt was added to the actual number of recorded attempts because the volume of sediment retrieved was less than the volume required. Because the samples were extruded in the sample management area and not on the sampling platform and because the demobilization activities for the day were completed before sample extrusion began, a field decision was made not to collect the additional volumes of sediment required. The addition of one attempt was based on the average volume of sediment (375 mL) collected in each attempt in the 10- to 30-inch bss depth interval in S2A1, which was greater than the deficit

(100 mL) at any of the four locations. The additional attempts in this depth interval may be attributable to (1) error in assessing the location of the sediment surface, which might have resulted in the actual depth of penetration being less than the measured depth of penetration; (2) deficient entry of sediment into the core tube (core shortening); (3) the sediment consisting of high levels of silt (50 to 67 percent), which might have caused plug formation in the coring tip that inhibited further sediment retrieval; or (4) sediment loss during sampler retrieval.

In S2A2, the Split Core Sampler performed well in the 4- to 12-inch bss depth interval, where the expected number of attempts equaled the actual number of attempts.

Based on the number of sampling attempts required in all four demonstration areas and multiple sampling depth intervals, the Split Core Sampler demonstrated the ability to consistently collect a specified volume of sediment except in the 10- to 30-inch bss depth interval in S2A1. Overall, the sampler required only 19 percent more attempts than expected (86 actual attempts versus

**Table 6-2. Comparison of Expected and Actual Number of Sampling Attempts for Split Core Sampler at Site 2**

Location	Number of Attempts in S2A1 (Lake)			
	0- to 4-Inch bss Depth Interval		10- to 30-Inch bss Depth Interval	
	Expected	Actual	Expected	Actual <sup>a</sup>
1A	3	3	1	1
1B	2	2	1	1
1E	3	3	1	3
2A	4	5	1	2
2C	3	3	1	2
2D	4	5	1	2
2E	4	4	1	4
3A	3	3	1	1
3B	2	2	1	1
3E	5	6	1	3
Total	33	36	10	20

Location	Number of Attempts in S2A2 (Wetland)	
	4- to 12-Inch bss Depth Interval	
	Expected	Actual
1A	1	1
1E	1	1
3C	1	1
5A	1	1
5E	1	1
Total	5	5

Notes:

bss = Below sediment surface

<sup>a</sup> At sampling locations 1E, 2C, 2E, and 3E, one attempt was added to the actual number of recorded attempts in order to account for the sample deficit compared to the sample volume required. Refer to Section 6.1.1.1 for additional explanation.

72 expected attempts). The Split Core Sampler performance results are comparable to those presented in Section 7.1.1.1 for the reference samplers at Site 1 and superior to those for the reference sampler at Site 2.

**6.1.1.2 Volume of Sediment Collected**

The volume of sediment collected by the Split Core Sampler in each sampling attempt in a given depth interval was divided by the corresponding design volume, and the resulting ratio was multiplied by 100 to estimate the percent sample recovery (PSR). The relative standard deviation (RSD) of the PSRs was calculated to evaluate

the ability of the sampler to consistently collect a specified volume of sediment; if the sampler were to recover an identical volume of sediment in every attempt, the RSD would equal zero. To properly evaluate the sampler’s performance, both PSR and RSD results should be considered because a low RSD, which indicates the sampler’s performance was consistent, may be based on consistently low PSRs. Figures 6-1 and 6-2 present PSRs for the Split Core Sampler at Sites 1 and 2, respectively. Table 6-3 presents PSR summary statistics (range, mean, and RSD) for the Split Core Sampler at both Sites 1 and 2.

Based on the PSR information for S1A1, the Split Core Sampler performed well in the 0- to 4- and 6- to 12-inch

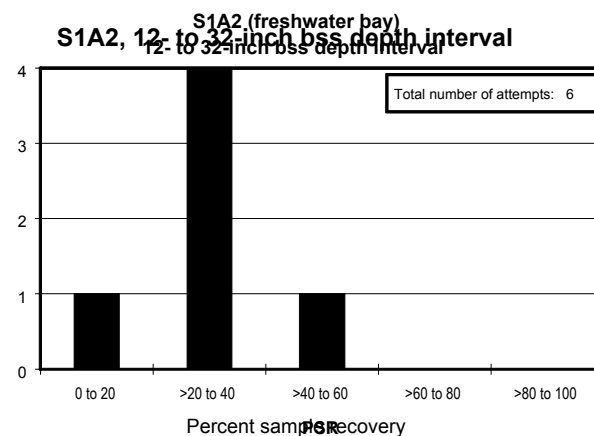
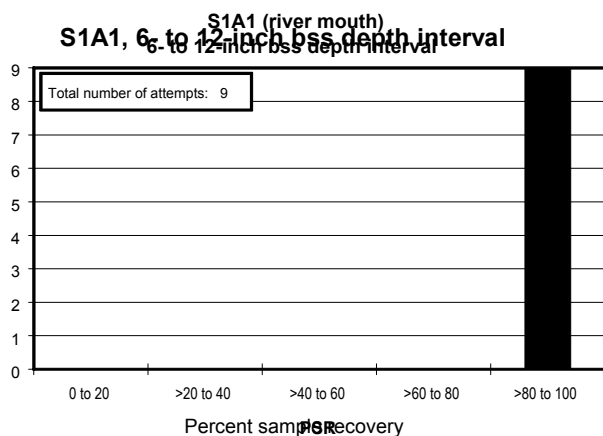
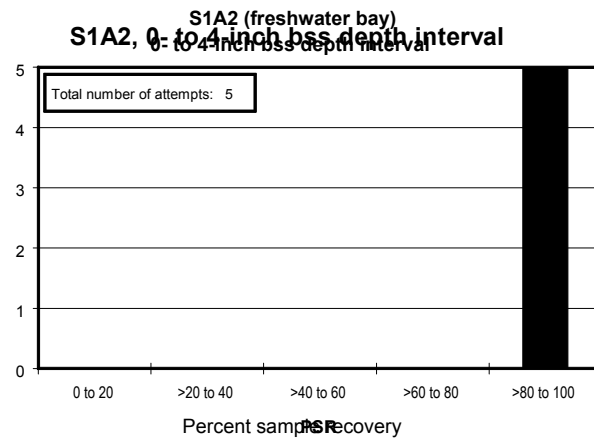
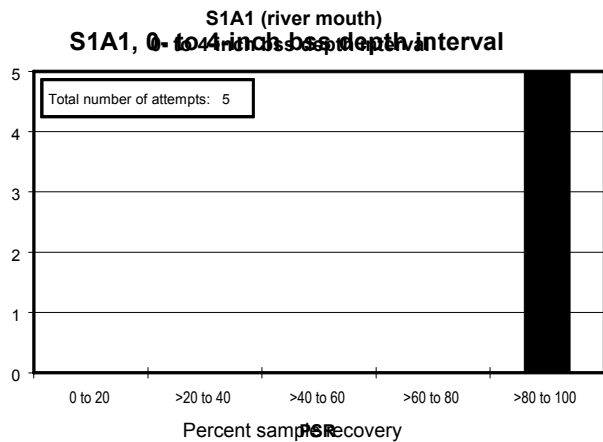

Note:

bss = Below sediment surface

Figure 6-1. Percent sample recoveries for Split Core Sampler at Site 1.

bss depth intervals. Specifically, as shown in Table 6-3, each attempt in the 0- to 4-inch bss depth interval had a PSR of 100, and the PSRs for the 6- to 12-inch bss depth interval ranged from 83 to 100 with a mean PSR of 93. For the 0- to 4-inch bss depth interval, the RSD was zero. For the 6- to 12-inch bss depth interval, the RSD was low (10 percent) because the recoveries fell in a narrow range (83 to 100 percent). Although no RSD criterion has been set for determining the ability to consistently sample a specified volume of sediment, an RSD of 30 percent or less is considered to be acceptable. Based on the RSDs, the Split Core Sampler was able to consistently sample the 0- to 4- and 6- to 12-inch bss depth intervals in S1A1.

In S1A2, the Split Core Sampler performed well in the 0- to 4-inch bss depth interval but did not perform well in the

12- to 32-inch bss depth interval. In the 0- to 4-inch bss depth interval, the Split Core Sampler achieved a PSR of 100 in every attempt. However, in the 12- to 32-inch bss depth interval, PSRs ranged from 20 to 60 and had a mean of only 37, as shown in Table 6-3. As shown in Figure 6-1, four of the six attempts in this interval fell in the greater than 20 to 40 percent range, and one attempt fell in each of the 0 to 20 and greater than 40 to 60 percent ranges. In the 12- to 32-inch bss depth interval, the RSD was 37 percent, which exceeded the 30 percent RSD guideline. The low recoveries in the 12- to 32-inch bss depth interval may be attributable to (1) error in assessing the location of the sediment surface, which might have resulted in the actual depth of penetration being less than the measured depth of penetration; (2) core shortening; (3) the sediment consisting of high levels of silt and clay,



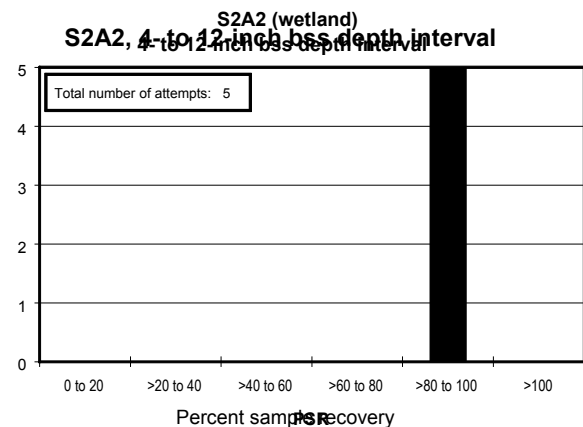
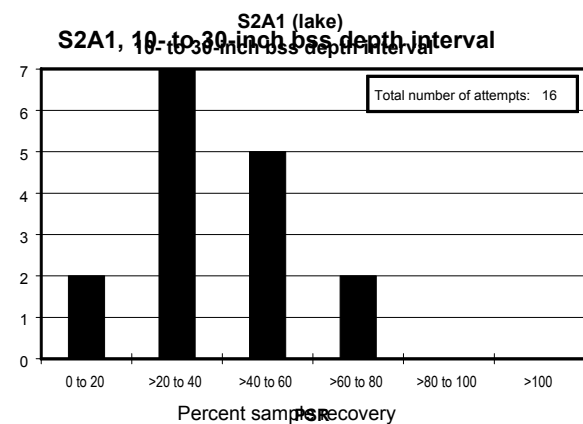
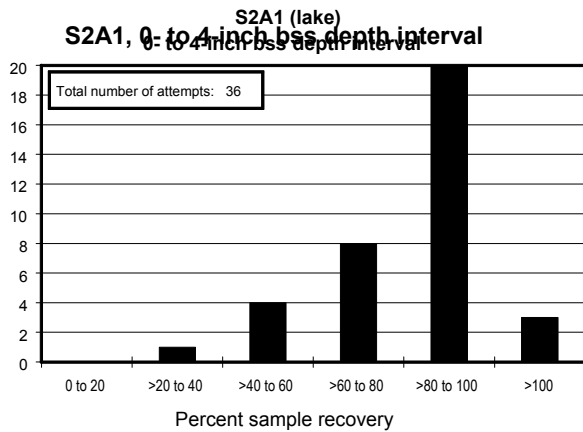

Notes:

bss = Below sediment surface

Percent sample recoveries exceeding 100 resulted from either the volumetric measurement error associated with the presence of void spaces when the sediment was transferred to a graduated container or sediment compaction in the core tube.

Figure 6-2. Percent sample recoveries for Split Core Sampler at Site 2.

which might have caused plug formation in the coring tip that inhibited further sediment retrieval; or (4) sediment loss during sampler retrieval. Based on the RSDs, the Split Core Sampler was able to consistently sample the 0- to 4-inch bss depth interval.

In S2A1, the Split Core Sampler performed well in the 0- to 4-inch bss depth interval but did not perform well in the 10- to 30-inch bss depth interval. As shown in Table 6-3, PSRs for the 0- to 4-inch bss depth interval ranged from 25 to 125 with a mean of 89. As shown in Figure 6-2, 23 of the 36 attempts in this interval had PSRs greater than 80, and 31 of the 36 attempts had PSRs greater than 60. Because most of the PSRs fell in a narrow range, the RSD of 26 percent was less than the 30 percent RSD guideline. In the 10- to 30-inch bss depth interval, the PSRs ranged from 0 to 75 with a mean of 38. As shown in Figure 6-2, 12 of the 16 attempts in this interval had PSRs in the greater than 20 to 40 and greater than 40 to 60 ranges. An RSD of 51 percent was calculated for the 10- to 30-inch bss depth interval, which indicates a high degree of inconsistency. The failures in this interval may be attributable to the reasons cited above for S1A2 except that in S2A1, the sediment did not consist of as much clay as did the sediment in S1A2 and thus provided less opportunity for plug formation.

In S2A2, the Split Core Sampler performed well in the 4- to 12-inch bss depth interval. A PSR of 100 was achieved in every attempt in this interval, resulting in an RSD of 0 percent.

Based on the volumes of sediment collected in all four demonstration areas and multiple sampling depth intervals, the Split Core Sampler demonstrated the ability to consistently collect a specified volume of sediment. An RSD below 30 percent was observed for five of the seven sampling depth intervals. Of the two remaining depth intervals, the RSDs ranged from 30 to 50 percent in one depth interval and were greater than 50 percent in the other. The sampler performed well in sampling depth intervals that did not exceed 12 inches bss: RSDs of 0 percent were observed for three such depth intervals, and RSDs of 10 and 26 were observed for the two remaining depth intervals. In these depth intervals, the Split Core Sampler collected more than 80 percent of its design volume in 47 of 60 attempts (78 percent). The sampler had mixed results in sampling depth intervals that exceeded 12 inches bss: RSDs of 37 and 51 percent were

**Table 6-3. Percent Sample Recovery Summary Statistics for Split Core Sampler**

Demonstration Area	Target Depth Interval (inches bss)	Actual Number of Attempts	PSR Range <sup>a</sup>	Mean PSR	RSD (%)
S1A1 (river mouth)	0 to 4	5	100	100	0
	6 to 12	9	83 to 100	93	10
S1A2 (freshwater bay)	0 to 4	5	100	100	0
	12 to 32	6	20 to 60	37	37
S2A1 (lake)	0 to 4	36	25 to 125	89	26
	10 to 30	16	0 to 75	38	51
S2A2 (wetland)	4 to 12	5	100	100	0

Notes:

- bss = Below sediment surface
- PSR = Percent sample recovery
- RSD = Relative standard deviation

<sup>a</sup> PSRs exceeding 100 resulted from either the volumetric measurement error associated with the presence of void spaces when the sediment was transferred to a graduated container or sediment compaction in the core tube.

observed in the 12- to 32- and 10- to 30-inch bss depth intervals in S1A2 and S2A1, respectively. For these depth intervals, the S1A2 RSD exceeded the 30 percent RSD guideline by only 7 percentage points, but the S2A1 RSD exceeded the guideline by 21 percentage points. The Split Core Sampler again performed as well as or better than the reference samplers (see Section 7.1.1.2).

### 6.1.2 Ability to Consistently Collect Sediment in a Specified Depth Interval

Primary objective P2 involved evaluating the Split Core Sampler’s ability to consistently collect sediment in a specified depth interval. This objective was addressed by comparing actual and target core lengths for each depth interval. The target core length for a sample was equal to the distance between the upper and lower boundaries of a depth interval. Because the core length measurements presented in this section do not account for void space in the core or rounding error, an attempt may have achieved an actual core length that equaled the target core length but may not have resulted in a PSR of 100.

Because of difficulties in assessing the location of the sediment surface, the sampling technician chose to push the Split Core Sampler beyond the specified depth intervals. Consequently, accuracy in targeting a specified depth interval may have been compromised. To assess overall accuracy in targeting specified depth intervals,

core lengths were compared to depths of sampler deployment; if a core length equals the depth of deployment, one may conclude that the core length accurately reflects the specified depth interval. However, in most cases for the Split Core Sampler and for the reference samplers, the core lengths were shorter than the depths of deployment, indicating the occurrence of core shortening or loss of sample during sampler retrieval. Because core shortening plays a significant role in sediment sampling using end-filling samplers and because both the Split Core Sampler and reference samplers are end-filling samplers, core shortening is briefly described below.

Core shortening, which primarily involves deficient entry of sediment into the core tube during sampler penetration, occurs because friction between sediment and the inside wall of the sampler gradually increases as the core tube penetrates the sediment, resulting in gradual thinning of the core by lateral extrusion in front of the core tube. As the friction changes with the depth of penetration, the extent of core shortening also changes. Thus, not all sediment layers may be uniformly represented within a given sample, and the actual core length will be less than the depth of sampler deployment (Blomqvist 1991). Core shortening is more likely to affect sampling attempts in deeper intervals than in shallower intervals. The degree of core shortening was probably somewhat reduced for the Split Core Sampler because an electric hammer was used to induce vibrations in the sampler in order to reduce the friction generated upon sediment entry into the core tube.

Table 6-4 presents the number of attempts in which the actual core length equaled the target core length, target core lengths, and mean actual core lengths. Initially, the Wilcoxon signed rank test was to be used to determine whether differences between the actual and target core lengths were statistically significant. However, review of the Wilcoxon signed rank test revealed that the test results for many of the data sets were inconsistent with the conclusions reached in comparing the actual and target core lengths for the reason stated in Section 6.1. Therefore, primary objective P2 was addressed by evaluating (1) the number of attempts in which the actual core length equaled the target core length and (2) the difference between the target core length and the mean actual core length.

In S1A1, the actual core lengths equaled the target core lengths for all attempts in the 0- to 4- and 6- to 12-inch bss depth intervals. The average core length retrieved in this area was about 21 percent shorter than the depth of sampler deployment, which is not significant.

In S1A2, actual core lengths equaled the target core length in all attempts in the 0- to 4-inch bss depth interval but failed to do so for any of the attempts in the 12- to 32-inch bss depth interval. Samples collected in the latter interval ranged in core length from 4.5 to 13.5 inches with a mean core length of 9 inches. The failures to obtain the target core length in this interval may be attributable to (1) error in assessing the location of the sediment surface, which

might have resulted in the actual depth of penetration being less than the measured depth of penetration; (2) core shortening; (3) the sediment consisting of high levels of silt and clay, resulting in formation of a plug in the coring tip that inhibited further sediment retrieval; (4) sediment compaction in the core tube; or (5) sediment loss during sampler retrieval. The average core length retrieved in this area was about 35 percent shorter than the depth of sampler deployment.

The results observed in S2A1 were similar to those observed in S1A2. In the 0- to 4-inch bss depth interval in S2A1, samples collected by the Split Core Sampler equaled the target core length in 34 of 36 attempts; consequently, the mean actual core length calculated for this interval (3.9 inches rounded to 4 inches) compared favorably to the target core length of 4 inches. However, none of the samples collected during the 16 attempts in the 10- to 30-inch bss depth interval equaled the target core length. The actual core lengths retrieved from this depth interval ranged from 0 to 16.5 inches, resulting in a mean core length of 10 inches that compared unfavorably to the target core length of 20 inches. The sampler failures in the deeper interval in S2A1 may be attributable to the reasons cited above for S1A2 except that in S2A1, the sediment did not consist of as much clay as did the sediment in S1A2 and thus provided less opportunity for plug formation. For both core tube lengths used, the average core length retrieved in this area was about 69 percent shorter than the depth of sampler deployment.

**Table 6-4. Comparison of Target and Actual Core Length Data for Split Core Sampler**

Demonstration Area	Target Depth Interval (inches bss)	Number of Attempts in Which Actual Core Length Equaled Target Core Length/Total Attempts	Target Core Length (inches)	Mean Actual Core Length (inches)
S1A1 (river mouth)	0 to 4	5/5	4	4
	6 to 12	9/9	6	6
S1A2 (freshwater bay)	0 to 4	5/5	4	4
	12 to 32	0/6	20	9
S2A1 (lake)	0 to 4	34/36	4	~4 <sup>a</sup>
	10 to 30	0/16	20	10
S2A2 (wetland)	4 to 12	5/5	8	8

Notes:

bss = Below sediment surface

<sup>a</sup> The calculated mean actual core length (3.9 inches) was rounded to the nearest integer.

In S2A2, the actual core lengths equaled the target core length for all attempts in the 4- to 12-inch bss depth interval. The average core length retrieved in this area was about 68 percent shorter than the depth of sampler deployment.

In summary, the demonstration results indicate that the Split Core Sampler was able to consistently collect sediment in sampling depth intervals that did not exceed 12 inches but did not perform well in the depth intervals below 12 inches bss. For sampling depth intervals not exceeding 12 inches bss, 58 of the 60 actual core lengths matched the target core lengths. For the depth intervals below 12 inches bss, none of the 22 actual core lengths matched the target core length. The Split Core Sampler performed as well as or better than the reference samplers (see Section 7.1.2).

### ***6.1.3 Ability to Collect Multiple Samples with Consistent Physical or Chemical Characteristics, or Both, from a Homogenous Layer of Sediment***

Primary objective P3 involved evaluating the Split Core Sampler's ability to collect multiple samples with consistent physical or chemical characteristics, or both, from a homogenous layer of sediment. This objective was addressed by calculating the RSD values for the sample analytical results for the 12- to 32-inch bss depth interval in S1A2 and the 0- to 4- and 10- to 30-inch bss depth intervals in S2A1. Based on the predemonstration investigation results, these three depth intervals were determined to be homogenous in terms of their physical characteristics, and the two S2A1 depth intervals were determined to be homogenous in terms of their chemical characteristics.

Figure 6-3 presents the demonstration analytical results for PSD in the 12- to 32-inch bss depth interval in S1A2. Figure 6-4 presents the demonstration analytical results for arsenic and PSD in the 0- to 4- and 10- to 30-inch bss depth intervals in S2A1. The demonstration analytical results for arsenic appeared to contain statistical outliers that indicated that the two S2A1 depth intervals might not be chemically homogenous. For this evaluation, outliers are defined as sample analytical results that are not within two standard deviations of the mean. The only outlier for samples collected by the Split Core Sampler was the

120 milligrams per kilogram (mg/kg) of arsenic in the 0- to 4-inch bss depth interval. However, outliers were also found in the arsenic analytical results for samples collected by the reference sampler (see Section 7.1.3), providing further evidence that the two S2A1 depth intervals may not be chemically homogenous. A similar analysis performed for the PSD data revealed no statistical outliers. Therefore, the Split Core Sampler was evaluated based only on its ability to collect multiple samples with consistent physical characteristics. RSDs were calculated for each depth interval based on the PSD analytical results for all locations sampled.

RSDs calculated for the PSD data were compared to the laboratory acceptance criterion of 15 percent for field triplicates (which was based on historical information) because RSDs less than or equal to 15 percent for all samples collected in a given depth interval and area may be more attributable to the laboratory's precision than to the sampler's ability to collect multiple samples with consistent physical characteristics. When the RSD for all samples in a depth interval was greater than 15 percent, it was compared to the measured RSD for the field triplicates, which were prepared by first homogenizing and then subsampling the sediment collected in a given depth interval, location, and area. An RSD for all samples that is less than the RSD for field triplicates may be more attributable to the laboratory's analytical procedure, the sample homogenization procedure implemented in the field, or both rather than the sampler's ability to collect physically consistent samples. However, PSD parameters with means less than 10 percent were not evaluated in this manner because at low levels, the analytical method is not as precise; as a result, it will generate high RSD values and may not actually reveal whether multiple samples with consistent physical characteristics were collected. Table 6-5 presents PSD summary statistics (range, mean, and RSD) calculated for the samples and field triplicates collected in each depth interval relevant to primary objective P3.

For the 12- to 32-inch bss depth interval in S1A2, the RSDs for the silt and clay were below the 15 percent laboratory acceptance criterion. The mean for the sand results for samples collected from the depth interval was less than 10 percent and was not evaluated using the criterion. However, the sand results exhibited a tight range (2 to 5 percent).

**12- to 32-inch bss depth interval**

<b>Location 1A</b> Sand: 2% Silt: 74% Clay: 24%				<b>Location 1E</b> Sand: 5% Silt: 70% Clay: 25%
		<b>Location 3C</b> Sand: 3% Silt: 66% Clay: 31%		
<b>Location 5A</b> Sand: 5% Silt: 72% Clay: 23%				<b>Location 5E</b> Sand: 2% Silt: 71% Clay: 27%

Note:

bss = Below sediment surface

**Figure 6-3. Split Core Sampler sample particle size distribution results for S1A2 (freshwater bay).**

For the 0- to 4-inch bss depth interval in S2A1, the RSDs for the sand and silt results were below the 15 percent laboratory acceptance criterion. The RSDs for the clay results were also below the 15 percent laboratory acceptance criterion, despite having a mean (9 percent) that was less than 10 percent.

For the 10- to 30-inch bss depth interval in S2A1, the RSD for the silt results was below the 15 percent laboratory acceptance criterion. However, the 23 percent RSD for the sand results for this depth interval was above the laboratory acceptance criterion and significantly above the

measured RSD for field triplicates (6 percent). Therefore, some of the variation in the sand results may be attributable to the Split Core Sampler's ability to collect samples with consistent physical characteristics. The variation, however, was not considered significant because it was only 8 percentage points greater than the laboratory acceptance criterion. The mean for the clay results for samples collected from this depth interval was less than 10 percent and was not evaluated using the criterion. However, the clay results exhibited a tight range (6 to 10 percent).

**0- to 4-inch bss depth interval**

<b>Location 1A</b> Arsenic: 24 mg/kg  Sand: 34% Silt: 57% Clay: 8%	<b>Location 1B</b> Arsenic: 40 mg/kg			<b>Location 1E</b> Arsenic: 120 mg/kg  Sand: 29% Silt: 59%
<b>Location 2A</b> Arsenic: 48 mg/kg		<b>Location 2C</b> Arsenic: 36 mg/kg  Sand: 39% Silt: 52% Clay: 8%	<b>Location 2D</b> Arsenic: 30 mg/kg	<b>Location 2E</b> Arsenic: 47 mg/kg
<b>Location 3A</b> Arsenic: 30 mg/kg  Sand: 42% Silt: 49% Clay: 9%	<b>Location 3B</b> Arsenic: 16 mg/kg			<b>Location 3E</b> Arsenic: 47 mg/kg  Sand: 36% Silt: 54% Clay: 10%

**10- to 30-inch bss depth interval**

<b>Location 1A</b> Arsenic: 5.0 mg/kg  Sand: 26% Silt: 64% Clay: 10%	<b>Location 1B</b> Arsenic: 5.3 mg/kg			<b>Location 1E</b> Arsenic: 4.7 mg/kg  Sand: 31% Silt: 60% Clay: 9%
<b>Location 2A</b> Arsenic: 4.6 mg/kg		<b>Location 2C</b> Arsenic: 5.4 mg/kg  Sand: 27% Silt: 67% Clay: 6%	<b>Location 2D</b> Sample not analyzed	<b>Location 2E</b> Arsenic: 4.7 mg/kg
<b>Location 3A</b> Arsenic: 5.3 mg/kg  Sand: 25% Silt: 67% Clay: 8%	<b>Location 3B</b> Arsenic: 5.0 mg/kg			<b>Location 3E</b> Arsenic: 5.2 mg/kg  Sand: 42% Silt: 50% Clay: 8%

Notes:

bss = Below sediment surface  
 mg/kg = Milligram per kilogram

The particle size distribution results for a given sample may not total 100 percent because of rounding or because some sediment did not pass through a U.S. Standard No. 4 sieve and was classified as gravel rather than sand, silt, or clay.

Figure 6-4. Split Core Sampler sample arsenic and particle size distribution results for S2A1 (lake).

**Table 6-5. Particle Size Distribution Summary Statistics for Split Core Sampler**

Demonstration Area	Target Depth Interval (inches bss)	Parameter	Number of Samples	Range (%)	Mean (%)	RSD (%) (All Samples)	RSD (%) (Field Triplicates)
S1A2 (freshwater bay)	12 to 32	Sand	5	2 to 5	3	46	54
		Silt	5	66 to 74	71	4	6
		Clay	5	23 to 31	26	13	9
S2A1 (lake)	0 to 4	Sand	5	29 to 42	36	14	4
		Silt	5	49 to 59	54	7	2
		Clay	5	8 to 10	9	10	6
	10 to 30	Sand	5	25 to 42	30	23	6
		Silt	5	50 to 67	62	11	3
		Clay	5	6 to 10	8	18	13

Notes:

- bss = Below sediment surface
- RSD = Relative standard deviation

In summary, the Split Core Sampler met primary objective P3 criteria except for an 8 percentage point exceedance in the RSD for sand results for the 10- to 30-inch bss depth interval in S2A1. Therefore, it was concluded that the Split Core Sampler was able to collect multiple samples with consistent physical characteristics.

**6.1.4 Ability to Collect a Representative Sample from a Clean Sediment Layer Below a Contaminated Sediment Layer**

To evaluate whether the Split Core Sampler could collect representative samples from a clean sediment layer that was below a contaminated sediment layer (primary objective P4), samples were collected from both clean and contaminated layers using the Split Core Sampler and the Hand Corer (a reference sampler). Because the predemonstration investigation results indicated that the 10- to 30-inch bss depth interval in S2A1 contained arsenic concentrations that were an order of magnitude less than those in the 0- to 4-inch bss depth interval in S2A1, the 10- to 30- and 0- to 4-inch bss depth intervals were considered to be clean and contaminated layers, respectively. Difficulties were encountered in assessing the location of the sediment surface in this demonstration area because a black, gelatinous material was present near the sediment surface. In addition, the location of the sediment surface varied significantly at several of the grid locations. This variation may have been caused by previous sampling attempts made during the demonstration.

Samples collected from both depth intervals were analyzed for arsenic. The contaminated layer concentrations were used only to document that a contaminated layer existed above the clean layer. The clean layer concentrations were used to compare the Split Core Sampler’s performance with that of the Hand Corer. To make this comparison, the null hypothesis was that the mean difference between the Split Core Sampler and Hand Corer sample arsenic concentrations for the clean layer equaled zero. The alternative hypothesis was that the mean difference between the Split Core Sampler and Hand Corer sample arsenic concentrations for the clean layer was not equal to zero. A two-tailed Wilcoxon signed rank test was used to compare the Split Core Sampler and Hand Corer sample concentrations.

Figure 6-5 presents the arsenic concentrations in the samples collected by the Split Core Sampler and the Hand Corer in both depth intervals in S2A1. Figure 6-5 also presents the difference between the arsenic concentrations in the samples collected by the two samplers in the 10- to 30-inch bss depth interval at each sampling location by subtracting the arsenic concentration in the Hand Corer sample from that in the Split Core Sampler sample. Each negative difference indicates that the sample collected by the Split Core Sampler was less impacted by the contaminated layer than the sample collected by the Hand Corer; each positive difference indicates that the reverse was true.

The sample analytical results showed that the 0- to 4-inch bss depth interval contained arsenic concentrations

**0- to 4-inch bss depth interval**

<b>Location 1A</b> SCS: 24 mg/kg HDC: 250 mg/kg	<b>Location 1B</b> SCS: 40 mg/kg HDC: 130 mg/kg			<b>Location 1E</b> SCS: 120 mg/kg HDC: 190 mg/kg
<b>Location 2A</b> SCS: 48 mg/kg HDC: 190 mg/kg		<b>Location 2C</b> SCS: 36 mg/kg HDC: 120 mg/kg	<b>Location 2D</b> SCS: 30 mg/kg HDC: 130 mg/kg	<b>Location 2E</b> SCS: 47 mg/kg HDC: 150 mg/kg
<b>Location 3A</b> SCS: 30 mg/kg HDC: 140 mg/kg	<b>Location 3B</b> SCS: 16 mg/kg HDC: 140 mg/kg			<b>Location 3E</b> SCS: 47 mg/kg HDC: 130 mg/kg

**10- to 30-inch bss depth interval**

<b>Location 1A</b> SCS: 5.0 mg/kg HDC: 24 mg/kg Diff: -19 mg/kg	<b>Location 1B</b> SCS: 5.3 mg/kg HDC: 8.5 mg/kg Diff: -3.2 mg/kg			<b>Location 1E</b> SCS: 4.7 mg/kg HDC: 16 mg/kg Diff: -11.3 mg/kg
<b>Location 2A</b> SCS: 4.6 mg/kg HDC: 8.3 mg/kg Diff: -3.7 mg/kg		<b>Location 2C</b> SCS: 5.4 mg/kg HDC: 9.7 mg/kg Diff: -4.3 mg/kg	<b>Location 2D</b> SCS: Sample not analyzed HDC: 13 mg/kg	<b>Location 2E</b> SCS: 4.7 mg/kg HDC: 7.2 mg/kg Diff: -2.5 mg/kg
<b>Location 3A</b> SCS: 5.3 mg/kg HDC: 7.2 mg/kg Diff: -1.9 mg/kg	<b>Location 3B</b> SCS: 5.0 mg/kg HDC: 8.2 mg/kg Diff: -3.2 mg/kg			<b>Location 3E</b> SCS: 5.2 mg/kg HDC: 52 mg/kg Diff: -46.8 mg/kg

Notes:

- bss = Below sediment surface
- Diff = Difference between arsenic concentrations in Split Core Sampler and Hand Corer samples
- HDC = Hand Corer
- mg/kg = Milligram per kilogram
- SCS = Split Core Sampler

Figure 6-5. Comparison of Split Core Sampler and reference sampler arsenic concentration results for S2A1 (lake).



significantly greater than those in the 10- to 30-inch bss depth interval. For the Split Core Sampler, the arsenic concentrations ranged from 16 to 48 mg/kg (not considering the anomalous result of 120 mg/kg for Location 1E) and from 4.6 to 5.4 mg/kg in the 0- to 4- and 10- to 30-inch bss depth intervals, respectively. For the Hand Corer, the arsenic concentrations ranged from 120 to 250 mg/kg and from 7.2 to 24 mg/kg (not considering the anomalous result of 52 mg/kg for Location 3E) in the 0- to 4- and 10- to 30-inch bss depth intervals, respectively. Explanation of these anomalies was beyond the scope of the demonstration.

Comparison of the arsenic concentration ranges showed that the Split Core Sampler sample concentration range was less than that for the Hand Corer for each depth interval. Based on the limited data available, arsenic concentrations in S2A1 appeared to decrease with increasing sediment depth. This observation suggests that significant compaction occurred in the sediment samples collected by the Split Core Sampler. Sediment sample compaction in the core tube of the Split Core Sampler is likely because (1) the depth of sampler deployment was greater than the core tube length; (2) the top of the sampler is closed by the top cap, and escape of sediment is limited by the ball check valve; and (3) vibrations induced by the electric hammer promote sample compaction. Sediment compaction in the Hand Corer core tube is not expected to be as significant because the latter two factors do not apply to the Hand Corer.

For the 10- to 30-inch bss depth interval, the arsenic concentrations in samples collected using the Split Core Sampler were less than the concentrations in samples collected using the Hand Corer for each paired observation. A statistical comparison of the Split Core Sampler and Hand Corer sample arsenic concentrations for the clean layer using the Wilcoxon signed rank test showed that the arsenic concentrations were different at a significance level of 0.05 and that there was only a 0.9 percent probability that the concentrations were not different. This conclusion seems reasonable based on the average difference between the Split Core Sampler and Hand Corer sample concentrations, which was about -11 mg/kg. This average difference was skewed by the anomalous paired observation for Location 3E (5.2 and 52 mg/kg of arsenic in the Split Core Sampler and Hand Corer samples, respectively). If the paired observation for Location 3E is not considered, the average difference in

concentrations is about -6.1 mg/kg, which is still significant because the reporting limit for arsenic was 1.0 mg/kg.

In summary, although the Split Core Sampler sample concentrations for the clean layer appeared to be less than the Hand Corer sample concentrations, because of sample compaction in the Split Core Sampler core tube, no conclusion could be drawn regarding the Split Core Sampler's ability to collect representative samples from a clean layer that is below a contaminated layer.

#### ***6.1.5 Ability to be Adequately Decontaminated***

Primary objective P5 involved evaluating the Split Core Sampler's ability to be adequately decontaminated (see Section 4.3). This objective was addressed by collecting equipment rinsate samples after sampler decontamination activities in S1A1 and S2A1. Specifically, the 6- to 12-inch bss depth interval in S1A1 and the 0- to 4-inch bss depth interval in S2A1 were chosen to address P5 because they contained high concentrations of PCBs and arsenic, respectively. Although it was intended that the evaluation be limited to these depth intervals, this was not possible because AMS simultaneously collected samples in multiple depth intervals. However, this deviation did not impact the primary objective. If the sampler were adequately decontaminated, the analytical results for the equipment rinsate samples would be below the analytical laboratory's reporting limits. To ensure that the water used to decontaminate the sampler was not contaminated, decontamination water blanks were also analyzed. Contaminant concentrations in both the equipment rinsate samples and decontamination water blanks were below the laboratory reporting limits for PCBs (1 part per billion) and arsenic (10 parts per billion). Thus, the Split Core Sampler demonstrated the ability to be adequately decontaminated.

#### ***6.1.6 Time Requirements for Sample Collection Activities***

Primary objective P6 involved evaluating the Split Core Sampler's time requirements for sample collection activities. These requirements were evaluated in all four demonstration areas but were not specifically evaluated by depth interval because samples were simultaneously collected in multiple depth intervals to reduce the total sample collection time. One technician was required for

sampler setup, sample collection, sample extrusion, sampler disassembly, and sampler decontamination in each of the four demonstration areas. The amounts of time required to complete these activities are shown in Table 6-6. The time measured for sample collection activities did not include the time taken for mobilization, demobilization, and maneuvering the sampling platforms to access sampling locations because these activities were not specific to the sampler; they were either site- or weather-related.

The sampler setup time ranged from 2 to 18 minutes. In S1A1 and S1A2, only 2 minutes was required for sampler setup because only a few extension rods (three in S1A1 and two in S1A2) were required. Because seven extension rods and an AMS tripod-mounted winch were required in S2A1, a greater amount of time (11 minutes) was required. Although only three extension rods were used in S2A2, 18 minutes was required for sampler setup. The main time requirement in this area was for the setup of the AMS tripod-mounted winch on a sampling platform that did not have enough space for easy winch setup.

The amount of time needed for sample collection ranged from 35 to 444 minutes and was mostly a function of (1) how many attempts were required in each depth interval and (2) demonstration area characteristics such as water depth and target sampling depth intervals. In S1A1, where the water depth was about 5 to 6 feet and the target sampling depth interval was 0 to 12 inches bss, the sample collection time per attempt ranged from 2 to 7 minutes. In S1A2, where the water depth interval was about 2 feet and the target sampling depth interval was 0 to 32 inches bss, the sample collection time per attempt ranged from 4 to 9 minutes. Two different core lengths were collected in

S2A1, where the water depth was about 18 feet. Collecting samples from 0 to 4 inches bss required 5 to 10 minutes per attempt, and collecting samples from 0 to 30 inches bss required 10 to 15 minutes per attempt. In S2A2, where the water depth ranged from 0.5 to 1.5 feet and the target sampling depth interval was 4 to 12 inches bss, the sample collection time per attempt ranged from 9 to 18 minutes. The additional time needed for each attempt in S2A2 was associated with (1) the sampler's depth of deployment and (2) the type of sampling platform used. Because of the heterogeneity of the sample matrix, the sampler was driven deeper than 4 feet bss to efficiently recover the sediment. In addition, the sampling platform in S2A2 did not have adequate work space to perform sample collection activities quickly.

The amount of time needed for sample extrusion ranged from 5 to 74 minutes and was strictly a function of how many sample cores were collected in each area. Approximately 1 to 2 minutes was needed for extrusion of each sample.

The amount of time needed for sampler disassembly was not recorded in any of the areas; sampler setup time was used as a substitute for sampler disassembly time. Therefore, the amount of time required for sampler disassembly was assumed to range from 2 to 18 minutes.

The amount of time needed for Split Core Sampler decontamination was evaluated only in S1A1 and S2A1. In S1A1, 17 minutes was needed for sampler decontamination, while 99 minutes was needed in S2A1. The difference between the amounts of time needed for sampler decontamination in these two areas can be accounted for by the following factors:

**Table 6-6. Time Required to Complete Sampling Activities for Split Core Sampler**

Activity	Time Required (minutes)			
	S1A1 (River Mouth)	S1A2 (Freshwater Bay)	S2A1 (Lake)	S2A2 (Wetland)
Sampler setup	2	2	11	18
Sample collection	36	35	444	64
Sample extrusion	11	6	74	5
Sampler disassembly	2	2	11	18
Sampler decontamination	17	Not evaluated	99	Not evaluated
Total	68	45	639	105

- Three extension rods were required in S1A1, but seven extension rods were required in S2A1.
- One 6-inch-long core tube and one 12-inch-long core tube were used in S1A1, whereas two additional 12-inch-long core tubes were used in S2A1.
- S2A1 was the first area sampled during the demonstration, and thus the sampling technician was implementing the decontamination procedure for the first time in this area.

Based on the demonstration results, a technician familiar with the Split Core Sampler would need 2 to 18 minutes for sampler setup, depending on (1) the number of extension rods required, (2) the number of core tubes used, and (3) whether or not the AMS tripod-mounted winch was required. Sample collection time increases with water depth; depth of sampler deployment; and to some extent, the type of sampling platform used. Approximately 5 to 10 minutes per sampling attempt could be expected for sample collection along with an additional 1 to 2 minutes for sample extrusion of each sample. It is estimated that sampler disassembly would take about the same amount of time as sampler setup. Sampler decontamination times in S1A1 (17 minutes) and S2A1 (99 minutes) differed greatly; the amount of time needed for sampler decontamination is a function of the number of core tubes and extension rods required. When sediment sampling is planned, the time required for setting up the sampling platform and for maneuvering the platform to position the sampler at the sampling location would have to be considered in addition to the times presented above.

## 6.2 Secondary Objectives

This section discusses the performance results for the Split Core Sampler based on the secondary objectives stated in Section 4.1. Secondary objectives S1 through S5 required evaluation of the Split Core Sampler's

- S1. Skill and training requirements for proper sampler operation
- S2. Ability to collect samples under a variety of site conditions
- S3. Ability to collect an undisturbed sample

S4. Durability based on materials of construction and engineering design

S5. Availability, including spare part availability

Secondary objectives were addressed based on (1) observations of the Split Core Sampler's performance during the demonstration and (2) information provided by AMS.

### 6.2.1 Skill and Training Requirements for Proper Sampler Operation

The Split Core Sampler is easy to operate, requiring minimal skills and training. Sampler assembly and sample collection procedures can be learned in the field with a few practice attempts. In addition, a written SOP accompanies the sampler when it is procured. Sampler operation is simple because the sampler does not require complete disassembly and reassembly after each sampling attempt. Only the coring tip requires removal to extrude the core tube liner containing the sediment core. The sampler can be operated by one person in both shallow (wading) and deep water depths because of its lightness; the fully equipped sampler, including one pair of 2-inch-diameter, 12-inch-long split core tubes; the top cap with the ball check valve; the coring tip; the coupling; one 12-inch-long, disposable, plastic core tube liner; one 4-foot-long, carbon-steel AMS extension rod; and one rubber-coated AMS cross handle, weighs about 10 lb. For water depths requiring use of additional extension rods, each 3-foot- and 4-foot-long extension rod weighs about 1.5 and 2 lb, respectively. Support equipment used during the demonstration included an AMS slide-hammer, an electric hammer (Bosch Model 11223 EVS) and power source, an SDS Max self-locking adaptor for attaching the electric hammer to the extension rod, an AMS tripod-mounted winch, and an extrusion rod for extruding sediment from the disposable, plastic core tube liner. For applications requiring use of an electric hammer, the electric hammer (37 lb) and power source (if portable, such as a generator) will likely be the heaviest pieces of equipment required to operate the sampler.

During the demonstration, minimal strength and stamina were required to collect samples with the Split Core Sampler in shallow and moderate depth intervals containing both unconsolidated and consolidated sediments. In all sampling areas, except S1A2, minimal

strength and stamina were required to drive the sampler to the desired depth intervals with the electric hammer. In S1A2, the sampler was manually driven by hand or with an AMS slide-hammer to the target depth interval; the sampling platform used was too small to accommodate the weight of a portable generator, and thus an electric hammer could not be used. Minimal strength and stamina were also required to retrieve the sampler at all sampling locations. An AMS tripod-mounted winch was used to dislodge the sampler from the sediment at four of ten locations in S2A1 and five of five locations in S2A2. The sampling technician chose to use the tripod-mounted winch when the strength and stamina required to manually dislodge the sampler were too great.

Previous sediment sampling experience is beneficial in selecting the most appropriate support equipment for a given Split Core Sampler application. For example, AMS decided to use an electric hammer after several unsuccessful practice attempts to collect samples using hand- or slide-hammer-assisted driving at the first sampling location in S2A1. The electric hammer was used to induce vibrations to the sampler in all demonstration areas where 110-volt power was available (S1A1, S2A1, and S2A2), resulting in more efficient recovery of samples. As a result of the same practice attempts, AMS also decided not to use the plastic basket retainers because the retainers were too stiff to be effective for the sediment to be sampled during the demonstration. Previous sediment sampling experience is also beneficial in accurately assessing the location of the sediment surface using the sampler, as is the case with other samplers.

### **6.2.2 Ability to Collect Samples Under a Variety of Site Conditions**

The Split Core Sampler demonstrated its ability to collect sediment samples under all conditions encountered during the demonstration, which included a variety of sampling platforms, water depths, sediment depths, and sediment compositions. During the demonstration, the range of sampling platforms used included wooden planks fastened to ladders in S2A2; an 18-foot-long, 4-foot-wide Jon boat in S1A2; a sturdier, 30-foot-long, 8-foot-wide pontoon boat in S2A1; and the EPA GLNPO *Mudpuppy* in S1A1. Because the sampler requires an external power source to operate the electric hammer, the electric hammer was not

used in S1A2; specifically, the Jon boat was too small to accommodate the weight of a portable generator. Sampler operation was feasible from any location on the sampling platforms used in S1A1, S1A2, and S2A2. However, a tripod-mounted winch was used to dislodge the sampler from the sediment at four of ten sampling locations in S2A1 and five of five sampling locations in S2A2. Use of the tripod-mounted winch in S2A1 dictated that the sampler be deployed through a 6-inch-diameter hole that had to be cut in the center of the pontoon boat. In S2A2, the tripod-mounted winch had to be positioned over the sampling locations by straddling the wooden planks.

Because of the lightness of the sampler and extension rods, water depth had no significant impact on the sampling technician's ability to deploy and retrieve the sampler. Water depths encountered during the demonstration ranged from about 0.5 foot in S2A2 to about 18 feet in S2A1. However, as with other samplers, the sampling technician's ability to assess the location of the sediment surface using the Split Core Sampler decreased with increasing water depth and turbidity. Because of the significant water depth and turbidity in S1A1, S1A2, and S2A1, the sampling technician could not see the sediment surface from the sampling platforms. An underwater video camera may have enabled the sampling technician to accurately assess the location of the sediment surface in these areas (Blomqvist 1991).

The Split Core Sampler was able to collect sediment samples in all shallow and moderate depth intervals (up to 36 inches bss) in each demonstration area. However, in all sampling attempts, the sampling technician chose to drive the sampler beyond the specified sampling depth intervals in order to retrieve sediment within the specified intervals. Furthermore, as stated in Section 6.1.1.1, the Split Core Sampler required 20 attempts in the 10- to 30-inch bss depth interval in S2A1, whereas 10 were expected to be required. These limitations may be attributable to (1) error in assessing the location of the sediment surface, which might have resulted in the actual depth of penetration being less than the measured depth of penetration; (2) deficient entry of sediment into the core tube (core shortening); (3) sediment plug formation in the coring tip that inhibited further sediment retrieval; or (4) sediment loss during sampler retrieval.

### 6.2.3 *Ability to Collect an Undisturbed Sample*

During the demonstration, the Split Core Sampler consistently collected sediment samples in which the sediment stratification was preserved; however, based on visual observations, the samples appeared to have been compacted. Bow wave disturbance near the sediment surface did not occur in S2A2; the water depth (0.5 to 1.5 feet) and low turbidity in this area allowed visual confirmation of the location of the sediment surface. Bow wave disturbance near the sediment surface in the remaining demonstration areas was unlikely because the speed of sampler deployment was controlled. Also, as mentioned above, sediment stratification was preserved in samples collected in these areas.

The total core length retrieved in each attempt using the Split Core Sampler was less than the depth of sampler deployment. The difference between the total core length retrieved and the depth of sampler deployment ranged from 2 to 7 inches in S1A1, 8.5 to 15.5 inches in S1A2, 12 to 48 inches in S2A1, and 29 to 46.5 inches in S2A2. These differences indicate that sampling bias might have occurred during sample collection in a given target depth interval.

### 6.2.4 *Durability Based on Materials of Construction and Engineering Design*

The primary components of the Split Core Sampler used during the demonstration included (1) 6- and 12-inch-long pairs of 300-series, stainless-steel split core tubes with interlocking, recessed channels and male, square-threaded ends; (2) a 400-series, stainless-steel coring tip; (3) a ball check valve-vented top cap; (4) a female, square-threaded coupling for attachment to additional stainless-steel split core tubes; and (5) 3- and 4-foot-long AMS extension rods made of stainless steel or carbon steel (see Figure 2-1). The sampler was operated with the AMS slide-hammer, the rubber-coated AMS cross handle, and the electric hammer. In addition, the sampler was used with disposable, plastic core tube liners and end caps to facilitate removal and transport of an intact sample from the split core tubes. Based on observations made during the demonstration, the Split Core Sampler is a sturdy sampler; none of the stainless-steel or carbon-steel components of the sampler was damaged or required repair or replacement. However, on several occasions sediment was caught in the ball check valve. As a result,

cleaning of the top cap using surface water or disassembly of the top cap was required to clear the obstruction.

During the demonstration, the Split Core Sampler was equipped with varying lengths of stainless-steel and carbon-steel AMS extension rods. A total length of up to 11 feet of extension rods was used to collect samples in S1A1, S1A2, and S2A2. In these three areas, no bending or bowing of the extension rods was observed. In S2A1, seven extension rods were coupled together to a combined length of about 27 feet. Throughout most of the sampling in S2A1, significant bowing of the coupled extension rods was observed; however, the rods were not damaged.

The only sampler component damaged during the demonstration was the disposable, plastic core tube liner. In S2A1 and S2A2, the sampling technician had to pound one end of the core tube liner against the side of the stainless-steel bowl in order to extrude the sample in the bowl. In a few cases, the degree of pounding required resulted in the core tube liner cracking or breaking. To rectify this problem, the sampling technician employed an extrusion rod in S1A1 and S1A2 to push the sample out the bottom of the core tube liner.

### 6.2.5 *Availability of Sampler and Spare Parts*

No primary component of the Split Core Sampler required replacement or servicing during the demonstration. Had a primary sampler component required replacement, it would not have been available in local retail stores. Sampler components may be obtained from AMS by overnight courier in 2 days or less, depending on the location of the sampling site.

## 6.3 *Data Quality*

The overall QA objective for the demonstration was to produce well-documented data of known quality. The TSAs conducted to evaluate data quality did not reveal any problems that would make the demonstration data unusable. The scope of these TSAs is described in Sections 4.3 and 4.4 of this ITVR.

This section briefly discusses the data quality of demonstration results for the Split Core Sampler; more detailed information is provided in the DER (Tetra Tech 1999b). Specifically, the data quality associated with the field measurement activities is discussed first, followed by

the data quality associated with the laboratory analysis activities.

### **6.3.1 Field Measurement Activities**

Field measurement activities conducted during the demonstration included measurement of the time associated with sample collection activities, water velocity, water depth, core length, volume of IDW, volume of sediment collected in a given sampling attempt, and depth of sampler deployment. Of these measurement parameters, specific acceptance criteria were set for the precision associated with the time and water velocity measurements only (EPA 1999). All time and water velocity measurements made during the demonstration met their respective criteria (see Table 6-7). Of the remaining parameters, some difficulties were encountered in measuring the volume of sediment collected in a given sampling attempt and the depth of sampler deployment, which are discussed below.

To measure the volume of sediment collected in a given sampling attempt, the sediment sample was transferred into a 2-L container graduated in increments of 20 mL. The container was tapped on a hard surface to minimize the presence of void spaces in the sample, the sample surface was made even using a spoon, and the volume of the sample was measured. However, because the void spaces could not be completely eliminated, the volumetric measurements are believed to have a positive bias that resulted in overestimation of PSRs. Because the total volume of the void spaces could not be measured, its impact on the PSR results could not be quantified. However, because the same volumetric measurement procedure was used for both the innovative and reference samplers, the PSR results could still be compared.

The depth of sampler deployment was measured with reference to the sediment surface. To identify the location of the sediment surface, the sampling technician lowered the sampler into the water and used the bottom end of the sampler to feel the sediment surface. Subsequently, the technician drove the sampler into the sediment to a depth that he estimated to be appropriate to collect a sediment sample in the specified depth interval. Overall during the demonstration, this approach resulted in an average core length that was about 21 to 69 percent shorter than the estimated depth of sampler deployment, indicating that the sampling technician may have had difficulty assessing the

location of the sediment surface. Although both the innovative and reference samplers used in the demonstration are end-filling samplers that do not collect uncompressed sediment samples, the degree of sediment sample compaction in the core tube varied depending on the sampler used. In addition, core shortening that could occur in both the innovative and reference samplers would impact the ability of the samplers to uniformly sample the sediment in a given depth interval; the extent of the core shortening, however, would depend on the sampler used. Therefore, conclusions drawn from a comparison of the sediment characteristics of the samples collected by the reference samplers with those of the samples collected by the Split Core Sampler should be carefully interpreted.

### **6.3.2 Laboratory Analysis Activities**

The laboratory analyses conducted for the demonstration included the following: (1) PCB, arsenic, and PSD analyses of sediment samples and (2) PCB and arsenic analyses of equipment rinsate samples. To evaluate the data quality of the laboratory analysis results, field-generated QC samples, PE samples, and laboratory QC check samples were analyzed. The field-generated QC samples included the field replicates and temperature blanks described in Section 4.3 of this ITVR. The PE samples and laboratory QC check samples are described in Section 4.4. The acceptance criteria for the QC samples are presented in Table 6-7.

All temperature blanks and field replicates subjected to PCB and arsenic analyses met the acceptance criteria, indicating that the sample homogenization procedure (field replicates) and sample preservation procedure (temperature blanks) implemented in the field met the demonstration requirements. However, as stated in Section 6.1.3, in one case the result of the field triplicate sample analysis for PSD did not meet the acceptance criterion. Despite this failure to meet the acceptance criterion, the PSD results are considered to be valid for the reasons detailed in Section 6.1.3.

The PE sample results for both the PCB and arsenic analyses met the acceptance criteria, indicating that the analytical laboratory accurately measured both PCBs and arsenic.

The analytical results for all laboratory QC check samples except the following met the acceptance criteria:

**Table 6-7. Summary of Quality Control Checks and Acceptance Criteria for Field and Laboratory Parameters**

Parameter	Quality Control Check	Matrix	Acceptance Criterion
<b>Field</b>			
Time required for sample collection activities	Simultaneous measurements	Not applicable	RPD $\leq$ 10
Water velocity	Consecutive measurements	Water	RPD $\leq$ 20
Cooler temperature	Temperature blank	Water	4 $\pm$ 2 °C
<b>Laboratory</b>			
PCBs	Method blank	Sediment and equipment rinsate	$\leq$ Reporting limit
	Surrogate	Sediment and equipment rinsate	Percent recovery: 50 to 160
	MS/MSD	Sediment	RPD $\leq$ 23 Percent recovery: 65 to 130 (Aroclor 1016) Percent recovery: 66 to 128 (Aroclor 1260)
		Extract duplicates	Sediment
	BS/BSD	Equipment rinsate	RPD $\leq$ 10
		Sediment	RPD $\leq$ 23 Percent recovery: 65 to 130 (Aroclor 1016) Percent recovery: 66 to 128 (Aroclor 1260)
	Equipment rinsate	RPD $\leq$ 20 Percent recovery: 73 to 123 (Aroclor 1016) Percent recovery: 77 to 120 (Aroclor 1260)	
	Field triplicates	Sediment	RSD $\leq$ 50
	Field duplicates	Equipment rinsate	RPD $\leq$ 20
	PE samples	Soil	87.9 to 238 parts per billion for Aroclor 1242 (certified value: 197 parts per billion) 900 to 2,400 parts per billion for Aroclor 1242 (certified value: 2,020 parts per billion)
Water		2.27 to 5.33 parts per billion for Aroclor 1248 (certified value: 4.26 parts per billion)	
Arsenic	Interference check solution A	Sediment and equipment rinsate	$\pm$ 2 times reporting limit
	Interference check solution AB	Sediment and equipment rinsate	Percent recovery: 80 to 120
	Serial dilution	Sediment and equipment rinsate	$\pm$ 10 percent of the original determination for samples with concentrations > 50 times the instrument detection limit
	Method blank	Sediment and equipment rinsate	$\leq$ Reporting limit
	MS/MSD	Sediment	RPD $\leq$ 10 Percent recovery: 67 to 109
	Postdigestion spike	Sediment and equipment rinsate	Percent recovery: 75 to 125
	Digestate duplicates	Sediment and equipment rinsate	RPD $\leq$ 10
	BS/BSD	Sediment	RPD $\leq$ 10 Percent recovery: 80 to 120
		Equipment rinsate	RPD $\leq$ 10 Percent recovery: 81 to 113
	Field triplicates	Sediment	RSD $\leq$ 30
Field duplicates	Equipment rinsate	RPD $\leq$ 20	

**Table 6-7. Summary of Quality Control Checks and Acceptance Criteria for Field and Laboratory Parameters (Continued)**

Parameter	Quality Control Check	Matrix	Acceptance Criterion
<b>Laboratory (Continued)</b>			
Arsenic (continued)	PE samples	Soil	Actual concentration = 239 mg/kg Expected recovery <sup>a</sup> = 199 mg/kg Actual recovery <sup>b</sup> = 183 mg/kg  Actual concentration = 6.02 mg/kg Expected recovery <sup>a</sup> = 5 mg/kg Actual recovery <sup>b</sup> = 4.81 mg/kg
		Water	25.0 to 39.4 parts per billion (certified value: 33.4 parts per billion)
PSD	Repeat analysis	Sediment	± 1 hydrometer unit
	Field triplicates	Sediment	RPD ≤ 15 for sand, silt, and clay

Notes:

- |        |   |                                     |     |   |                             |
|--------|---|-------------------------------------|-----|---|-----------------------------|
| >      | = | Greater than                        | PCB | = | Polychlorinated biphenyl    |
| ≤      | = | Less than or equal to               | PE  | = | Performance evaluation      |
| ±      | = | Plus or minus                       | PSD | = | Particle size distribution  |
| BS/BSD | = | Blank spike/blank spike duplicate   | RPD | = | Relative percent difference |
| mg/kg  | = | Milligram per kilogram              | RSD | = | Relative standard deviation |
| MS/MSD | = | Matrix spike/matrix spike duplicate |     |   |                             |

<sup>a</sup> The expected recovery is based on typical recoveries of arsenic in soil during multiple interlaboratory studies.

<sup>b</sup> The actual recovery is the mean arsenic concentration in the PE sample based on four replicate analyses by the proficiency testing laboratory.

(1) MS/MSD samples for analysis for PCBs in the sediment matrix and (2) equipment rinsate samples for PCB analysis. These issues and their likely impact on data quality are discussed below.

For the sediment matrix, in all MS/MSD samples analyzed for PCBs, Aroclor 1016 was recovered at levels higher than the upper limit of the acceptance criterion, indicating a positive bias in the PCB results for sediment samples. However, the analytical laboratory had no problem meeting the acceptance criteria for control samples such as BS/BSDs. For this reason, the failure to meet the acceptance criterion for MS/MSD sample analysis was attributed to matrix interference. Because Aroclor 1016 was recovered at levels higher than the upper limit of the acceptance criterion in all MS/MSD samples associated with both the innovative and reference samplers, the PCB results could still be compared. The MS/MSD spiking compounds (Aroclors 1016 and 1260) were selected based on the Aroclors detected during the predemonstration investigation and as recommended in SW-846 Method 8082.

Also for the sediment matrix, in one out of three MS/MSD pairs analyzed for PCBs, Aroclor 1260 was recovered at a level less than the lower limit of the acceptance criterion in the MS sample, but the recovery in the associated MSD sample was acceptable. Because the investigative samples contained only Aroclor 1242, of the two spiking compounds used to prepare the MS/MSD samples, only the Aroclor 1016 recoveries were considered to be relevant based on the PCB congener distribution; the Aroclor 1260 recoveries were not considered to be relevant. Therefore, the low recovery associated with Aroclor 1260 had no impact on data quality.

In all equipment rinsate samples analyzed for PCBs, decachlorobiphenyl (the surrogate) was recovered at levels lower than the lower limit of the acceptance criterion, indicating a negative bias in the PCB results for equipment rinsate samples. However, the analytical laboratory had no problem meeting the acceptance criteria for control samples such as PE samples and deionized water blanks. For this reason, the failure to meet the surrogate recovery acceptance criterion for the equipment rinsate sample



---

analysis was attributed to matrix interference. Because the surrogate was recovered at levels lower than the lower limit of the acceptance criterion in all equipment rinsate

samples associated with both the innovative and reference samplers, the PCB results could still be compared.

---

## Chapter 7

### Performance of the Reference Samplers

To verify a wide range of performance attributes, the innovative sediment sampler demonstration had both primary and secondary objectives. Primary objectives were critical to the technology evaluation and were intended to produce quantitative results regarding technology performance. Secondary objectives provided information that was useful but did not necessarily produce quantitative results regarding technology performance. The approach used to address each primary and secondary objective for the Split Core Sampler and reference samplers is discussed in Chapter 4. This chapter describes the performance of the reference samplers based on the primary objectives (excluding costs associated with sample collection activities) and secondary objectives. This chapter also discusses the data quality of demonstration results for the reference samplers.

The performance of the Split Core Sampler is discussed in Chapter 6, costs associated with sample collection activities (primary objective P7) are presented in Chapter 8, and the performance of the Split Core Sampler and reference samplers is compared in summary form in Chapter 9.

#### 7.1 Primary Objectives

This section discusses the performance results for the reference samplers based on the primary objectives stated in Section 4.1 except for primary objectives P4 and P7, which are addressed in Section 6.1.4 and Chapter 8, respectively. Otherwise, the primary objectives discussed in this section are the same as those discussed in Section 6.1. During the demonstration, the sampling technicians were provided an opportunity to practice sample collection at each demonstration area until they felt confident enough to initiate demonstration sampling.

To address primary objectives, samples were collected using two different reference samplers, the Vibrocorer in S1A1 and the Hand Corer in the other areas. The areas and depth intervals sampled are the same as those described in Section 6.1 except that the 4- to 6-foot bss and 9- to 11-foot bss depth intervals in S1A1 and S2A2, respectively, were not sampled using the reference samplers. The Vibrocorer had difficulty fully penetrating the 4- to 6-foot bss depth interval because of the presence of clay hardpan and was thus unable to collect samples from this interval in S1A1; the sampling technicians made only a few attempts and decided not to complete sampling in this depth interval. In S2A2, the Hand Corer was not used for the 9- to 11-foot bss depth interval because it is not designed to collect samples at depths below 3 feet bss. Consequently, the reference samplers were not evaluated with respect to these two depth intervals. The numbers of investigative and QC samples collected in each area, sediment sample volumes required, and sample analytical parameters are discussed in Chapter 4.

The demonstration results for the reference samplers under primary objectives P1 and P2 were evaluated using the Wilk-Shapiro test to determine whether the results were normally distributed. Because most of the results were not normally distributed, the Wilk-Shapiro test was used in an attempt to evaluate whether the results followed a lognormal distribution. The test revealed that the results either were not lognormally distributed or could not be tested for lognormality because they contained values that were equal to zero. For these reasons, the Student's t-test, a parametric test, was not used to perform hypothesis testing; the Wilcoxon signed rank test, a nonparametric test, was used as an alternative to the Student's t-test. As described in Section 6.1, Statistix<sup>®</sup> was used to perform statistical evaluations of the demonstration results (Analytical Software 1996). Appendix C provides details on the statistical methods used for data evaluation.

### 7.1.1 Ability to Consistently Collect a Specified Volume of Sediment

Primary objective P1 involved evaluating the reference samplers' ability to consistently collect a specified volume of sediment. This objective was addressed by comparing (1) the actual number of sampling attempts required to collect a specified volume of sediment to the expected number of attempts (rounded to the nearest higher integer) at each sampling location in each target depth interval and (2) the actual volume of sediment collected in the specified target depth interval in each attempt to the calculated sampler volume (design volume) for the depth interval. The expected number of attempts was determined by dividing the specified sample volume by the design volume for the depth interval. The results of these comparisons are summarized below.

#### 7.1.1.1 Number of Sampling Attempts Required

Tables 7-1 and 7-2 present the expected and actual number of reference sampler sampling attempts for each depth interval at Sites 1 and 2, respectively. Initially, the Wilcoxon signed rank test was used to determine whether the difference between the expected and actual number of attempts was statistically significant. However, the conclusions drawn from the Wilcoxon signed rank test were inconsistent with the conclusions reached in comparing the expected and actual number of attempts (see Appendix C for an example).

In S1A1, the Vibrocorer performed well in the 0- to 4- and 6- to 12-inch bss depth intervals, where the expected number of attempts equaled the actual number of attempts. As stated above, the Vibrocorer had difficulty fully penetrating the 4- to 6-foot bss depth interval because of the presence of clay hardpan and was thus unable to collect samples from this interval in S1A1; the sampling technicians made a few attempts and decided not to complete sampling in this depth interval.

In S1A2, the Hand Corer performed well in the 0- to 4-inch bss depth interval, where the expected number of attempts equaled the actual number of attempts, but did not perform as well in the 12- to 32-inch bss depth interval. In the 12- to 32-inch bss depth interval, the Hand Corer required three additional attempts. The additional attempts in this depth interval may be attributable to (1) error in assessing the location of the sediment surface, which might have resulted in the actual depth of penetration being less than the measured depth of penetration; (2) deficient entry of sediment into the core tube (core shortening); (3) the sediment consisting of high levels of silt (63 to 72 percent) and clay (22 to 31 percent), which might have caused plug formation in the coring tip that inhibited further sediment retrieval; or (4) sediment loss during sampler retrieval.

In S2A1, the Hand Corer again performed better in the shallower of the two depth intervals sampled. In the 0- to 4-inch bss depth interval, the Hand Corer required 39 attempts, whereas 33 attempts were expected. In the 10- to 30-inch bss depth interval, the Hand Corer required more than three times the expected number of attempts to

**Table 7-1. Comparison of Expected and Actual Number of Sampling Attempts for Reference Samplers at Site 1**

Location	Number of Attempts in S1A1 (River Mouth) Using Vibrocorer				Number of Attempts in S1A2 (Freshwater Bay) Using Hand Corer			
	0- to 4-inch bss Depth Interval		6- to 12-inch bss Depth Interval		0- to 4-inch bss Depth Interval		12- to 32-inch bss Depth Interval	
	Expected	Actual	Expected	Actual	Expected	Actual	Expected	Actual
1A	1	1	1	1	1	1	1	1
1E	1	1	1	1	1	1	1	2
3C	1	1	1	1	1	1	1	3
5A	1	1	1	1	1	1	1	1
5E	1	1	1	1	1	1	1	1
Total	5	5	5	5	5	5	5	8

Note:

bss = Below sediment surface

**Table 7-2. Comparison of Expected and Actual Number of Sampling Attempts for Reference Sampler at Site 2**

Number of Attempts in S2A1 (Lake) Using Hand Corer					Number of Attempts in S2A2 (Wetland) Using Hand Corer		
Location	0- to 4-inch bss Depth Interval		10- to 30-inch bss Depth Interval		Location	4- to 12-inch bss Depth Interval	
	Expected	Actual	Expected	Actual		Expected	Actual
1A	3	3	1	4	1A	1	2
1B	4	4	1	5	1E	1	12 <sup>a</sup>
1E	3	4	1	3	3C	1	3
2A	2	2	1	2	5A	1	2
2C	5	7	1	3	5E	1	1
2D	2	2	1	1	<b>Total</b>	<b>5</b>	<b>20</b>
2E	2	2	1	2			
3A	5	7	1	6			
3B	4	5	1	3			
3E	3	3	1	2			
<b>Total</b>	<b>33</b>	<b>39</b>	<b>10</b>	<b>31</b>			

Notes:

bss = Below sediment surface

<sup>a</sup> Sampling was discontinued after the 12 attempts made at this location failed to collect the specified sediment volume.

collect adequate sample volumes, and the actual number of attempts equaled the expected number of attempts at only one of the ten sampling locations. The sampler failures in S2A1 may be attributable to the reasons cited above for S1A2 except that in S2A1, the sediment does not consist of as much clay as does the sediment in S1A2 and thus exhibited less tendency for plug formation in the coring tip. Also, during sampler retrieval in S2A1, the sampler’s flutter valve did not seat properly in a few attempts. This malfunction resulted in partial or complete loss of vacuum in the core tube and subsequent sample loss.

In the 4- to 12-inch bss depth interval in S2A2, the Hand Corer had significant difficulty in collecting sediment; 20 attempts were recorded, whereas 5 were expected. Of the 20 attempts, more than half (12) were recorded at Location 1E. Eight attempts were recorded at the remaining four locations, whereas four were expected. Moreover, more than 20 attempts would have been necessary to complete sampling in this depth interval because sampling was discontinued at Location 1E after the 12 attempts made at this location failed to collect the specified sediment volume. The Hand Corer experienced

the greatest number of problems in S2A2, perhaps because this area contained significant amounts of partially decomposed reeds and leaves and live vegetation. As a result, the sediment matrix was highly heterogenous and was difficult to cut through, capture, and retain. The sampler failures in S2A2 may also be attributed to the reasons cited above for S1A2.

In summary, the demonstration results indicate that the Vibrocorer demonstrated the ability to consistently collect a specified volume of sediment in the 0- to 4- and 6- to 12-inch bss depth intervals because the number of actual attempts equaled the number of expected attempts. However, the Vibrocorer did not collect samples in the 4- to 6-foot bss depth interval. The Hand Corer collected surficial sediment well but had difficulty collecting samples at depths greater than 4 inches bss. In the two 0- to 4-inch bss depth intervals, the Hand Corer required only 16 percent more attempts than expected (44 actual attempts versus 38 expected attempts). In contrast, in the deeper intervals, the Hand Corer required nearly 200 percent more attempts than expected (59 actual attempts versus 20 expected attempts), indicating a high level of inconsistency in collecting specified volumes of sediment.

### 7.1.1.2 Volume of Sediment Collected

The volume of sediment collected by the reference samplers in each sampling attempt in a given depth interval was divided by the corresponding design volume, and the resulting ratio was multiplied by 100 to estimate the PSR. The RSD of the PSRs was calculated to evaluate the ability of the reference samplers to consistently collect a specified volume of sediment; if a sampler were to recover an identical volume of sediment in every attempt, the RSD would equal zero. Both PSR and RSD results should be considered to properly evaluate the sampler's performance because a low RSD, which indicates that the sampler's performance was consistent, may be based on

consistently low PSRs. Figures 7-1 and 7-2 present PSRs for the reference samplers at Sites 1 and 2, respectively. Table 7-3 presents PSR summary statistics (range, mean, and RSD) for both sites.

The Vibrocorer performed well in the 0- to 4- and 6- to 12-inch bss depth intervals in S1A1. Each attempt in the 0- to 4-inch bss depth interval had a PSR of 100. In the 6- to 12-inch bss depth interval, a narrow PSR range of 79 to 83 resulted in an RSD of 3 percent, which is less than the 30 percent RSD guideline. Although the Vibrocorer collected a consistent volume of sediment in this depth interval, it did not collect more than 83 percent of its design volume.

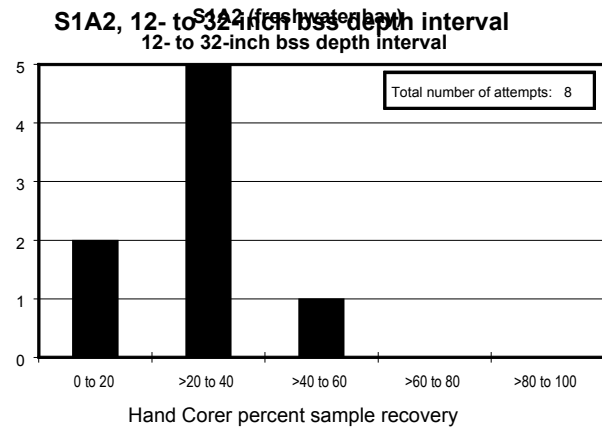
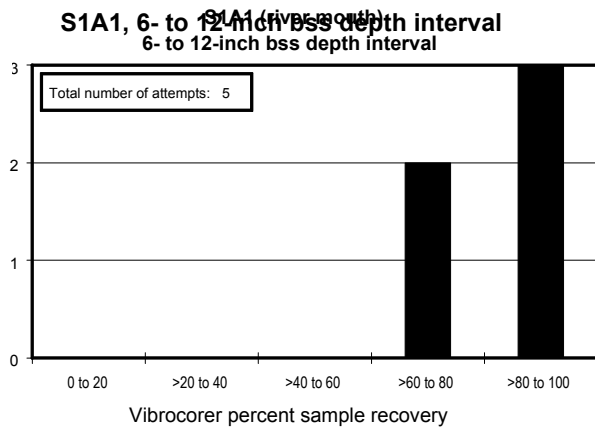
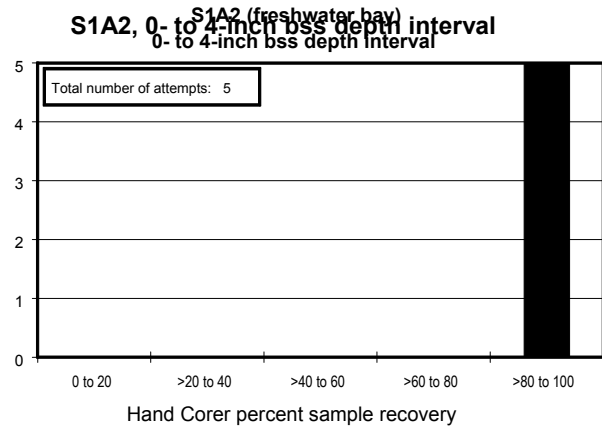
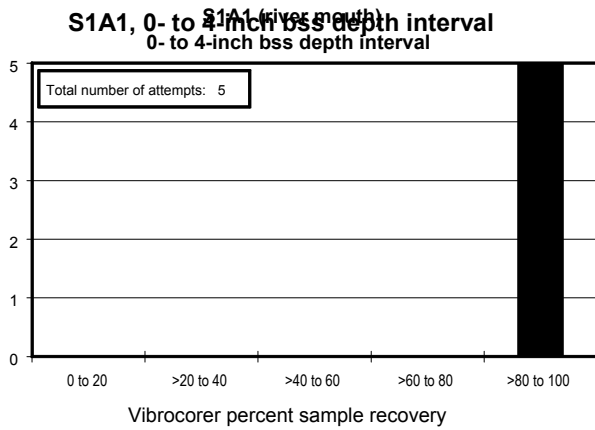

Note:

bss = Below sediment surface

Figure 7-1. Percent sample recoveries for Vibrocorer and Hand Corer at Site 1.

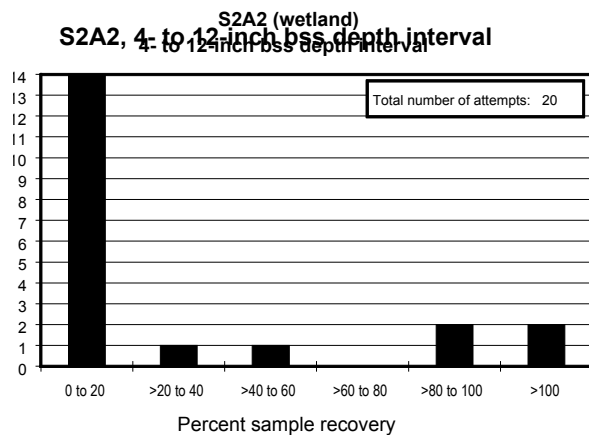
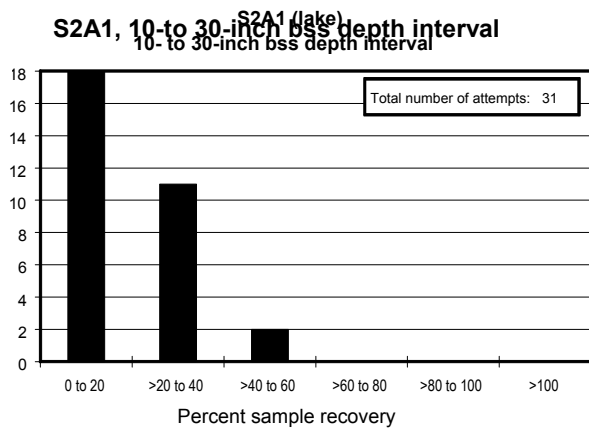
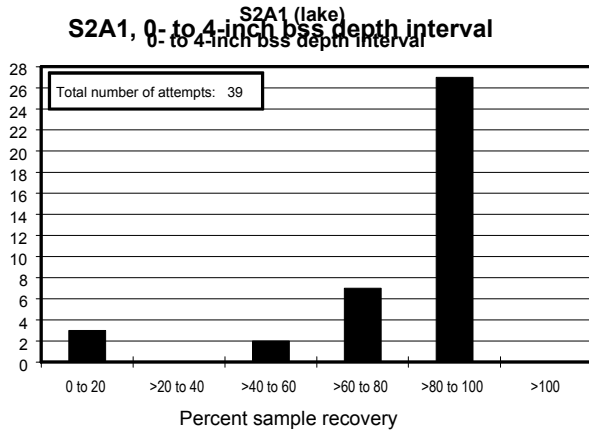

Notes:

bss = Below sediment surface

Percent sample recoveries exceeding 100 resulted from the volumetric measurement error associated with the presence of void spaces when the sediment was transferred to a graduated container.

In S1A2, the Hand Corer performed well in the 0- to 4-inch bss depth interval but performed poorly in the 12- to 32-inch bss depth interval. In the 0- to 4-inch bss depth interval, the Hand Corer achieved a PSR of 100 in every attempt. However, in the 12- to 32-inch bss depth interval, PSRs ranged from 15 to 55 and had a mean of only 31, as shown in Table 7-3. As shown in Figure 7-1, five of the eight attempts in this interval fell in the greater than 20 to 40 percent range, and two of the eight attempts fell in the 0 to 20 percent range. Because the recoveries fell in a narrow range, the RSD of 35 percent exceeded the RSD guideline of 30 percent by only 5 percentage points.

In S2A1, the Hand Corer performed well in the 0- to 4-inch bss depth interval but did not perform well in the 10- to 30-inch bss depth interval. As shown in Table 7-3, PSRs for the 0- to 4-inch bss depth interval ranged from 0 to 100 with a mean of 85. As shown in Figure 7-2, 27 of the 39 attempts in this interval had PSRs of 80 to 100, and 34 of the 39 attempts had PSRs greater than 60. Because most of the PSRs fell in a narrow range, the RSD of 33 percent compared favorably to the 30 percent RSD guideline. In the 10- to 30-inch bss depth interval, the PSRs ranged from 0 to 50 with a mean of 21. As shown in Figure 7-2, most of the PSRs fell in the 0 to 20 range. An RSD of 62 percent was calculated for the 10- to 30-inch bss depth interval, which indicates a high degree of inconsistency.

In the 4- to 12-inch bss depth interval in S2A2, the Hand Corer had difficulty collecting sediment. As shown in Table 7-3, PSRs for S2A2 ranged from 0 to 125 with a mean of 22. This wide range of PSRs resulted in an extremely high RSD of 161 percent. Figure 7-2 shows that 70 percent of the attempts fell in the 0 to 20 PSR range, which indicates consistently low recoveries.

In summary, the Vibrocorer performed well in the 0- to 4- and 6- to 12-inch bss depth intervals, and the Hand Corer performed well in the shallow depth intervals but not in the deeper intervals. In the 0- to 4- and 6- to 12-inch bss depth intervals in S1A1, the Vibrocorer had RSDs that were less than the 30 percent RSD guideline. The Hand Corer performed well in the 0- to 4-inch bss depth intervals, in S1A2 and S2A1 for which low RSDs (0 and 33 percent, respectively) were observed. In the 10- to 30- and 4- to 12-inch bss depth intervals in S2A1 and S2A2, the RSDs of 62 and 161 percent, respectively, were well above the 30 percent RSD guideline.

Figure 7-2. Percent sample recoveries for Hand Corer at Site 2.

**Table 7-3. Percent Sample Recovery Summary Statistics for Reference Samplers**

Demonstration Area	Reference Sampler	Target Depth Interval (inches bss)	Actual Number of Attempts	PSR Range <sup>a</sup>	Mean PSR	RSD (%)
S1A1 (river mouth)	Vibrocorer	0 to 4	5	100	100	0
		6 to 12	5	79 to 83	82	3
S1A2 (freshwater bay)	Hand Corer	0 to 4	5	100	100	0
		12 to 32	8	15 to 55	31	35
S2A1 (lake)	Hand Corer	0 to 4	39	0 to 100	85	33
		10 to 30	31	0 to 50	21	62
S2A2 (wetland)	Hand Corer	4 to 12	20 <sup>b</sup>	0 to 125	22	161

Notes:

- bss = Below sediment surface
- PSR = Percent sample recovery
- RSD = Relative standard deviation

<sup>a</sup> PSRs exceeding 100 resulted from the volumetric measurement error associated with the presence of void spaces when the sediment was transferred to a graduated container.

<sup>b</sup> More than 20 attempts would have been necessary to complete sampling in this depth interval because sampling was discontinued at Location 1E after the 12 attempts made at this location failed to collect the specified sediment volume.

### 7.1.2 Ability to Consistently Collect Sediment in a Specified Depth Interval

Primary objective P2 involved evaluating the reference samplers' ability to consistently collect sediment in a specified depth interval. This objective was addressed by comparing actual and target core lengths for each depth interval. The target core length for a sample was equal to the distance between the upper and lower boundaries of a depth interval. Because the core length measurements presented in this section do not account for void space, an attempt may have achieved an actual core length that equaled the target core length but may not have resulted in a PSR of 100.

Because of difficulties in assessing the location of the sediment surface, the sampling technicians chose to push the samplers beyond the specified depth intervals. Consequently, accuracy in determining a specified depth interval may have been compromised. To assess overall accuracy in determining specified depth intervals, core lengths were compared to depths of sampler deployment; if a core length equals the depth of deployment, one may conclude that the core length accurately reflects the specified depth interval. However, in most cases for the

reference samplers, the core lengths were shorter than the depths of deployment, indicating the occurrence of core shortening or loss of sample during sampler retrieval. Because core shortening plays a significant role in sediment sampling using end-filling samplers and because both reference samplers are end-filling samplers, core shortening is briefly described below.

Core shortening, which primarily involves deficient entry of sediment into the core tube during sampler penetration, occurs because friction between sediment and the inside wall of the sampler gradually increases as the core tube penetrates the sediment, resulting in gradual thinning of the core by lateral extrusion in front of the core tube. As the friction changes with the depth of penetration, the extent of core shortening also changes. Thus, not all sediment layers may be uniformly represented within a given sample, and the actual core length will be less than the depth of sampler deployment (Blomqvist 1991). Core shortening is more likely to affect sampling attempts in deeper intervals than in shallower intervals. Core shortening is expected to be less prevalent for the Vibrocorer, because the vibrations produced by this sampler reduce the friction generated upon sediment entry into the core tube.

Table 7-4 presents the number of attempts in which the actual core length equaled the target core length, target core lengths, and mean actual core lengths. Initially, the Wilcoxon signed rank test was to be used to determine whether differences between the actual and target core lengths were statistically significant. However, review of the Wilcoxon signed rank test results revealed that the results for many of the data sets were inconsistent with the conclusions reached in comparing the target and actual core lengths for the reasons described in Section 6.1. Therefore, primary objective P2 was addressed by evaluating (1) the number of attempts in which the actual core length equaled the target core length and (2) the difference between the target core length and the mean actual core length.

In S1A1, samples collected by the Vibrocorer equaled the target core length in five out of five attempts in both the 0- to 4- and 6- to 12-inch bss depth intervals. However, these results are not surprising because the depth of sampler deployment was at least 52 inches for these attempts. The Vibrocorer had difficulty fully penetrating the 4- to 6-foot bss depth interval in S1A1 because of the presence of clay hardpan and was thus unable to collect samples in this interval; the sampling technicians made a few attempts and then decided not to complete sampling in this interval. The average core length retrieved in this area was about 23 percent shorter than the depth of sampler deployment.

In S1A2, samples collected by the Hand Corer equaled the target core length in all attempts in the 0- to 4-inch bss depth interval but failed to do so in any of the attempts in the 12- to 32-inch bss depth interval. Samples collected in the latter interval ranged in core length from 3 to 11 inches, with a mean core length of 7 inches. The additional attempts in this interval may be attributable to (1) error in assessing the location of the sediment surface, which might have resulted in the actual depth of penetration being less than the measured depth of penetration; (2) core shortening; (3) the sediment consisting of high levels of silt and clay, resulting in formation of a plug in the coring tip that inhibited further sediment retrieval; or (4) sediment loss during sampler retrieval. The average core length retrieved in this area was about 52 percent shorter than the depth of sampler deployment.

The results observed in S2A1 were similar to those observed in S1A2. In the 0- to 4-inch bss depth interval in S2A1, samples collected by the Hand Corer equaled the target core length in 36 of 39 attempts; consequently, the mean actual core length calculated for this interval (3.7 inches rounded to 4 inches) compared favorably to the target core length of 4 inches. However, none of the samples collected during the 31 attempts in the 10- to 30-inch bss depth interval equaled the target core length. The actual core lengths in this depth interval ranged from 0 to 12 inches, resulting in a mean core length of 5 inches

**Table 7-4. Comparison of Target and Actual Core Length Data for Reference Samplers**

Demonstration Area	Reference Sampler	Target Depth Interval (inches bss)	Number of Attempts in Which Actual Core Length Equaled Target Core Length/Total Attempts	Target Core Length (inches)	Mean Actual Core Length (inches)
S1A1 (river mouth)	Vibrocorer	0 to 4	5/5	4	4
		6 to 12	5/5	6	6
S1A2 (freshwater bay)	Hand Corer	0 to 4	5/5	4	4
		12 to 32	0/8	20	7
S2A1 (lake)	Hand Corer	0 to 4	36/39	4	~4 <sup>a</sup>
		10 to 30	0/31	20	5
S2A2 (wetland)	Hand Corer	4 to 12	3/20	8	2

Notes:

bss = Below sediment surface

<sup>a</sup> The calculated mean actual core length (3.7 inches) was rounded to the nearest integer.



that compared unfavorably to the target core length of 20 inches. The sampler failures in the deeper interval in S2A1 may be attributable to the reasons cited for S1A2 except that in S2A1, the sediment does not consist of as much clay as does the sediment in S1A2 and thus provides less opportunity for plug formation in the coring tip. In S2A1, during sampler retrieval the sampler's flutter valve did not seat properly in a few attempts. This malfunction resulted in partial or complete loss of vacuum within the core tube and thus sample loss. The average core length retrieved in this area was about 41 percent shorter than the depth of sampler deployment.

In S2A2, only 3 of the 20 core lengths collected by the Hand Corer in the 4- to 12-inch bss depth interval equaled the target core length. The actual core lengths ranged from 0 to 8 inches, with a mean core length of 2 inches that compared poorly to the target core length of 8 inches. As mentioned above, the Hand Corer experienced the greatest number of problems in S2A2, perhaps because this area contained significant amounts of partially decomposed reeds and leaves and live vegetation. As a result, the sediment matrix was heterogenous and was difficult to cut through, capture, and retain. The average core length retrieved in this area was about 78 percent shorter than the depth of sampler deployment.

In summary, the demonstration results indicate that the Vibrocorer was able to consistently collect sediment from the 0- to 4- and 6- to 12-inch bss depth intervals in S1A1 because the core lengths for all attempts in both depth intervals equaled the target core lengths. The Hand Corer collected surficial sediment well but had difficulty collecting samples from depths greater than 4 inches bss. Specifically, samples collected in the 0- to 4-inch bss depth intervals equaled the target core length in 41 of 44 attempts. However, the actual core lengths did not equal the target core length for any of the samples collected in the 12- to 32- and 10- to 30-inch bss depth intervals in S1A2 and S2A1, respectively, and equaled the target core length in only 3 of 20 attempts in the 4- to 12-inch bss depth interval in S2A2.

### ***7.1.3 Ability to Collect Multiple Samples with Consistent Physical or Chemical Characteristics, or Both, from a Homogenous Layer of Sediment***

Primary objective P3 involved evaluating the Hand Corer's ability to collect multiple samples with consistent physical or chemical characteristics, or both, from a homogenous layer of sediment. This objective was addressed by calculating the RSD values for the sample analytical results for the 12- to 32-inch bss depth interval in S1A2, and the 0- to 4- and 10- to 30-inch bss depth intervals in S2A1. Based on the predemonstration investigation results, these three depth intervals were determined to be homogenous in terms of their physical characteristics, and the two S2A1 depth intervals were determined to be homogenous in terms of their chemical characteristics.

For the Hand Corer samples, Figure 7-3 presents the demonstration analytical results for PSD in the 12- to 32-inch bss depth interval in S1A2, and Figure 7-4 presents the demonstration analytical results for arsenic and PSD in the 0- to 4- and 10- to 30-inch bss depth intervals in S2A1. The demonstration analytical results for arsenic contain statistical outliers that indicate that the two S2A1 depth intervals may not be chemically homogenous. For this evaluation, the outliers are defined as sample analytical results that are not within two standard deviations of the mean; the outliers include the 250 mg/kg of arsenic in the 0- to 4-inch bss depth interval and the 52 mg/kg of arsenic in the 10- to 30-inch bss depth interval in S2A1. Outliers were also found in the analytical results for samples collected by the Split Core Sampler (see Section 6.1.3), providing further evidence that the two S2A1 depth intervals may not be chemically homogenous. A similar analysis performed for the PSD results revealed no statistical outliers. Therefore, the Hand Corer was evaluated based only on its ability to collect multiple samples with consistent physical characteristics. RSDs were calculated for each depth interval based on the PSD analytical results for all locations sampled.

Table 7-5 presents the PSD summary statistics (range, mean, and RSD) calculated for the samples and field triplicates collected using the Hand Corer in each depth interval relevant to primary objective P3. As stated in

**12- to 32-inch bss depth interval**

<b>Location 1A</b> Sand: 6% Silt: 72% Clay: 22%				<b>Location 1E</b> Sand: 6% Silt: 63% Clay: 31%
		<b>Location 3C</b> Sand: 3% Silt: 70% Clay: 27%		
<b>Location 5A</b> Sand: 4% Silt: 68% Clay: 28%				<b>Location 5E</b> Sand: 3% Silt: 67% Clay: 30%

Note:

bss = Below sediment surface

**Figure 7-3. Hand Corer sample particle size distribution results for S1A2 (freshwater bay).**

Section 6.1.3, RSDs calculated for the PSD results were compared to the laboratory acceptance criterion of 15 percent for field triplicates. When the RSD for all samples from a given depth interval was greater than 15 percent, it was compared to the measured RSD for the field triplicates. An RSD for all samples that is less than the RSD for field triplicates may be more attributable to the laboratory’s analytical procedure, the sample homogenization procedure implemented in the field, or both rather than the sampler’s ability to collect physically consistent samples. However, PSD parameters

with means less than 10 percent were not evaluated in this manner because at low levels, the analytical method is not as precise; as a result, it will generate high RSD values and may not actually reveal whether multiple samples with consistent were have been collected.

For the 12- to 32-inch bss depth interval in S1A2, the RSDs for silt and clay results were below the 15 percent laboratory acceptance criterion. The mean sand level was less than 10 percent and was not evaluated using the

**0- to 4-inch bss depth interval**

<b>Location 1A</b> Arsenic: 250 mg/kg Sand: 32% Silt: 63% Clay: 2%	<b>Location 1B</b> Arsenic: 130 mg/kg			<b>Location 1E</b> Arsenic: 190 mg/kg Sand: 26% Silt: 72% Clay: 2%
<b>Location 2A</b> Arsenic: 190 mg/kg		<b>Location 2C</b> Arsenic: 120 mg/kg Sand: 46% Silt: 48% Clay: 2%	<b>Location 2D</b> Arsenic: 130 mg/kg	<b>Location 2E</b> Arsenic: 150 mg/kg
<b>Location 3A</b> Arsenic: 140 mg/kg Sand: 32% Silt: 63% Clay: 5%	<b>Location 3B</b> Arsenic: 140 mg/kg			<b>Location 3E</b> Arsenic: 130 mg/kg Sand: 29% Silt: 71% Clay: 0%

**10- to 30-inch bss depth interval**

<b>Location 1A</b> Arsenic: 24 mg/kg Sand: 38% Silt: 61% Clay: 0%	<b>Location 1B</b> Arsenic: 8.5 mg/kg			<b>Location 1E</b> Arsenic: 16 mg/kg Sand: 35% Silt: 62% Clay: 3%
<b>Location 2A</b> Arsenic: 8.3 mg/kg		<b>Location 2C</b> Arsenic: 9.7 mg/kg Sand: 43% Silt: 53% Clay: 3%	<b>Location 2D</b> Arsenic: 13 mg/kg	<b>Location 2E</b> Arsenic: 7.2 mg/kg
<b>Location 3A</b> Arsenic: 7.2 mg/kg Sand: 37% Silt: 58% Clay: 4%	<b>Location 3B</b> Arsenic: 8.2 mg/kg			<b>Location 3E</b> Arsenic: 52 mg/kg Sand: 35% Silt: 62% Clay: 3%

Notes:

bss = Below sediment surface  
 mg/kg = Milligram per kilogram

The particle size distribution results for a given sample may not total 100 percent because of rounding or because some sediment did not pass through the U.S. Standard No. 4 sieve and was classified as gravel rather than sand, silt, or clay.

**Figure 7-4. Hand Corer sample arsenic and particle size distribution results for S2A1 (lake).**

**Table 7-5. Particle Size Distribution Summary Statistics for Hand Corer**

Demonstration Area	Depth (inches bss)	Parameter	Number of Samples	Range (%)	Mean (%)	RSD (%) (All Samples)	RSD (%) (Field Triplicates)
S1A2 (freshwater bay)	12 to 32	Sand	5	3 to 6	4	34	0
		Silt	5	63 to 72	68	5	3
		Clay	5	22 to 31	28	13	8
S2A1 (lake)	0 to 4	Sand	5	26 to 46	33	23	3
		Silt	5	48 to 72	63	15	6
		Clay	5	0 to 5	2	18	29
	10 to 30	Sand	5	35 to 43	38	9	14
		Silt	5	53 to 62	59	6	2
		Clay	5	0 to 4	3	60	71

Notes:

- bss = Below sediment surface
- RSD = Relative standard deviation

criterion. However, the sand levels exhibited a tight range (3 to 6 percent).

For the 0- to 4-inch bss depth interval in S2A1, the RSD for silt levels (15 percent) met the laboratory acceptance criterion, but the RSD for sand levels (23 percent) did not. Because the RSD for sand levels exceeded the criterion but the RSD for sand levels in the field triplicates (3 percent) met the criterion, some of the variation in the sand results may be attributable to the Hand Corer’s ability to collect multiple samples with consistent physical characteristics. The mean clay level in samples collected in the 0- to 4-inch bss depth interval in S2A1 was less than 10 percent and was not evaluated using the criterion. However, the clay levels exhibited a tight range (0 to 5 percent).

For the 10- to 30-inch bss depth interval in S2A1, the RSDs for sand and silt levels were below the 15 percent laboratory acceptance criterion. The mean clay level in samples collected in the depth interval was less than 10 percent and was not evaluated using the criterion. However, the clay levels exhibited a tight range (0 to 4 percent).

In summary, the Hand Corer met the primary objective P3 criteria except for an exceedance in the RSD for sand levels in the 0- to 4-inch bss depth interval in S2A1. Therefore, it was concluded that the Hand Corer is generally able to collect multiple samples with consistent physical characteristics.

#### 7.1.4 Ability to be Adequately Decontaminated

Primary objective P5 involved evaluating the reference samplers’ ability to be adequately decontaminated. This objective was addressed by collecting equipment rinsate samples after sampler decontamination activities in S1A1 and S2A1. Specifically, the 6- to 12-inch bss depth interval in S1A1 and the 0- to 4-inch bss depth interval in S2A1 were chosen as the depth intervals where P5 was evaluated because they contained high concentrations of PCBs and arsenic, respectively. Although it was intended that the evaluation of P5 be limited to these depth intervals, because samples were simultaneously collected in multiple depth intervals, the primary objective was addressed for a given area, not for a given depth interval. However, this deviation did not impact the evaluation of primary objective P5.

If the reference samplers were adequately decontaminated, the analytical results for the equipment rinsate samples would be below the analytical laboratory’s reporting limits. To ensure that the water used to decontaminate the samplers was not itself contaminated, decontamination water blanks were also analyzed. Contaminant concentrations in both the equipment rinsate samples and decontamination water blanks were below the laboratory reporting limits for PCBs (1 part per billion) and arsenic (10 parts per billion). Thus, both the Vibrocorer and Hand Corer demonstrated the ability to be adequately decontaminated.

### 7.1.5 Time Requirements for Sample Collection Activities

Primary objective P6 involved evaluating the reference samplers' time requirements for sample collection activities. These requirements were evaluated in all four demonstration areas but were not specifically evaluated by depth interval because samples were simultaneously collected in multiple depth intervals to reduce the overall sample collection time. For the Hand Corer, one technician was required for sampler setup, sample collection, sampler disassembly, and sampler decontamination, except in S2A1 where two technicians were required for sample collection. For the Vibrocorer, two technicians were required for sampler setup and sample collection, and one technician was required for sampler decontamination in S1A1. Sampler disassembly was not necessary because the Vibrocorer is a permanent fixture aboard the EPA GLNPO's *Mudpuppy* and does not contain components that require disassembly.

The amounts of time required to complete the sampling activities are shown in Table 7-6. The time measured for sample collection activities did not include the time taken for mobilization, demobilization, and maneuvering the sampling platforms to sampling locations because these latter activities were not sampler-specific; rather, they were either site- or weather-related.

To complete sampling activities in S1A1, the Vibrocorer required 8 minutes for sampler setup, 124 minutes for sample collection in the 0- to 4- and 6- to 12-inch bss

depth intervals (15 to 16 minutes per attempt), and 10 minutes for sampler decontamination.

For the Hand Corer, sampler setup required 4 minutes in S1A2. Sampler setup times are not available for S2A1 and S2A2. In S2A1, the setup time was included in the sample collection time for one particular sample, and in S2A2, the setup time was not recorded. However, the setup time recorded at S1A2 is probably representative of the time needed for a moderately experienced technician to set up the Hand Corer; S1A2 was the last demonstration area sampled with the Hand Corer, so the technician had ample opportunity to practice sampler setup in other areas.

Sample collection times for the Hand Corer ranged from 47 to 550 minutes in S1A2, S2A1, and S2A2. Sample collection with the Hand Corer required 4 to 7 minutes per attempt in S1A2 and S2A2 but 10 to 16 minutes per attempt in S2A1. More extension rods were required in S2A1 than in the other two areas because of the water depth; five rods were required in S2A1, but only one rod was required in S1A2 and S2A2. The weight of the additional extension rods made use of a tripod-mounted winch necessary to hold the sampler steady during sampling; incorporating the tripod-mounted winch into the sampling process in S2A1 accounted for the extra time necessary for sample collection.

Hand Corer disassembly required 2 minutes in S1A2 and S2A2 but 4 minutes in S2A1. The additional time required in S2A1 can again be attributed to the use of additional extension rods in this area.

**Table 7-6. Time Required to Complete Sampling Activities for Reference Samplers**

Activity	Time Required (minutes)			
	S1A1 (River Mouth) Vibrocorer	S1A2 (Freshwater Bay) Hand Corer	S2A1 (Lake) Hand Corer	S2A2 (Wetland) Hand Corer
Sampler setup	8	4	Included in sample collection	Not recorded
Sample collection	124	47	550	163 <sup>a</sup>
Sampler disassembly	0	2	4	2
Sampler decontamination	10	Not evaluated	40	Not evaluated
Total	142	53	594	165 <sup>a</sup>

Note:

<sup>a</sup> Hand Corer sampling was completed at four of five sampling locations. At the fifth location, sampling was discontinued after 12 attempts failed to collect the specified sediment volume.

Decontamination of the Hand Corer was evaluated only in S2A1 and required 40 minutes. Because of the numerous extension rods required in this area, the decontamination time measured in S2A1 may not be representative. In addition, S2A1 was the first demonstration area sampled, and decreased decontamination times were observed for the other samplers as the technicians became more familiar with the decontamination procedures required for the demonstration.

In summary, a technician familiar with the Vibrocorer would be expected to require 8 minutes for sampler setup, 15 to 16 minutes for each sampling attempt, and 10 minutes for sampler decontamination. A technician familiar with the Hand Corer would be expected to require 4 minutes for sampler setup, 4 to 7 minutes for each sampling attempt, and 2 to 4 minutes for sampler disassembly. However, more time may be necessary for sample collection depending on the water depth. It is uncertain how much time an experienced technician would need to adequately decontaminate the Hand Corer, but it is likely that the technician would require less than the 40 minutes observed in S2A1. The amount of decontamination time would likely have been less in the other areas because the technician would have had more practice in implementing the required decontamination procedures as well as fewer extension rods to decontaminate. When sediment sampling activities are planned, the time required for setting up the sampling platform and for maneuvering the platform to position the sampler at the sampling location would have to be considered in addition to the times presented above.

## 7.2 Secondary Objectives

This section discusses the performance results for the reference samplers based on secondary objectives S1 through S5 stated in Section 4.1. Secondary objectives were addressed based on observations of the reference samplers' performance during the demonstration and on information provided by the EPA GLNPO.

### 7.2.1 *Skill and Training Requirements for Proper Sampler Operation*

The Hand Corer is easy to operate, requiring minimal skills and training. Sampler assembly and sample collection procedures can be learned in the field with a

few practice attempts. In addition, a written SOP accompanies the sampler when it is procured. The sampler can be operated by one person in shallow (wading) water depths because of its lightness (12 lb). Sampler operation with plastic core liners is simple because the sampler does not require complete disassembly and reassembly after each sampling attempt. Only the nose piece requires removal to extrude the plastic core liner containing the sediment core. In water depths requiring use of extension rods, sampler operation becomes more cumbersome because of the combined weight of the stainless-steel sampler and the galvanized-steel extension rods (5 lb each). Because of the heaviness of the sampler equipped with five extension rods, two personnel and a tripod-mounted winch were needed to deploy and retrieve the sampler at each sampling location in S2A1, where the water depth was about 18 feet.

During the demonstration, minimal strength and stamina were required to collect samples with the Hand Corer from shallow and moderate depth intervals containing both unconsolidated and consolidated sediments. Specifically, minimal strength and stamina were required to drive the sampler into and retrieve it from the 0- to 4-inch bss depth interval in S1A2 and S2A1 and the moderate depth intervals ranging from 10 to 30 and 12 to 32 inches bss in S2A1 and S1A2, respectively. However, moderate to significant strength and stamina were required to collect samples from a depth interval containing partially decomposed reeds and leaves and live vegetation. Specifically, moderate to significant strength and stamina were required to drive the sampler into and retrieve it from the 4- to 12-inch bss depth interval in S2A2. Sediment in this interval was consolidated and was predominantly sand with low water content. The consolidated interval increased the amount of force required to drive the Hand Corer. However, the difficulty in driving the sampler was likely attributable to the sampler's inability to cut through the sediment that contained significant amounts of partially decomposed reeds and leaves and live vegetation.

Previous sediment sampling experience is beneficial in selecting the most appropriate support equipment for a given Hand Corer application. For example, the sampling technicians chose to use a tripod-mounted winch in S2A1 because of the significant strength and stamina that would have been required to deploy and retrieve the sampler in that area if a winch was not used. Previous sediment sampling experience is also beneficial in accurately

assessing the location of the sediment surface using the sampler, as is the case with other samplers.

Operation of the Vibrocorer requires moderate skills and training, and the sampler must be operated by at least two persons using a sampling platform. Several hours of hands-on training with an experienced Vibrocorer sampling technician is recommended to learn the proper operation of the sampler and its support equipment. In addition, during the demonstration, the power supply for the Vibrocorer malfunctioned during sample collection. The source of the malfunction was identified and corrected by on-site personnel. Therefore, it is recommended that at least one of the sampling technicians have electrical and mechanical experience to be able to correct malfunctioning support equipment for the Vibrocorer. Also, previous sediment sampling experience is beneficial in assessing the location of the sediment surface using the sampler, as is the case with other samplers.

During the demonstration, minimal strength and stamina were required to collect samples with the Vibrocorer in S1A1. Although the vibrohead and core tube weigh about 150 lb, sampler deployment and retrieval were controlled with an A-frame and winch on the EPA GLNPO's *Mudpuppy*. The physical effort required to remove the core tube from the vibrohead and to extract the sample from the core tube was minimal.

### **7.2.2 Ability to Collect Samples Under a Variety of Site Conditions**

The Hand Corer demonstrated its ability to collect sediment samples under all conditions encountered during the demonstration, which included a variety of sampling platforms, water depths, sediment depths, and sediment compositions. The range of sampling platforms used included wooden planks fastened to ladders in S2A2; an 18-foot-long, 4-foot-wide Jon boat in S1A2; and a sturdier, 30-foot-long, 8-foot-wide pontoon boat in S2A1. Because the sampler does not require electricity or a tripod-mounted winch for deployment in shallow water, sampler operation was feasible from any location on the sampling platforms used in S1A2 and S2A2. At S2A1, however, where the water depth was about 18 feet, two sampling technicians and a tripod-mounted winch were needed to properly operate the sampler because of the combined weight of the sampler (12 lb) and the five extension rods and turning handle (27 lb). Use of the

tripod-mounted winch required that a 6-inch-diameter hole be cut in the center of the pontoon boat to deploy and retrieve the sampler.

As with other samplers, the ability to assess the location of the sediment surface with the Hand Corer decreases with increasing water depth and turbidity. Because of the significant water depth in S2A1 and turbidity in S1A2, the sampling technicians could not see the sediment surface from the sampling platforms. An underwater video camera may have enabled the sampling technicians to accurately assess the location of the sediment surface in these areas (Blomqvist 1991).

The Hand Corer was able to collect sediment samples in all shallow and moderate depth intervals (less than 36 inches bss) in each demonstration area where the sampler was deployed. However, as discussed in Section 7.1.1.1, the actual number of attempts required to collect the specified volume of sediment exceeded the expected number at most sampling locations. The additional attempts may be attributable to (1) error in assessing the location of the sediment surface, which may have resulted in the actual depth of penetration being less than the measured depth of penetration; (2) deficient entry of sediment into the core tube (core shortening); (3) plug formation in the coring tip that inhibited further sediment retrieval; or (4) partial or complete loss of the sediment core through the bottom end of the sampler as a result of partial or complete loss of vacuum in the core tube caused by incomplete closure of the flutter valve. Incomplete closure of the flutter valve was observed during a few attempts in S2A2 when partially decomposed plant matter in the 0- to 4-inch bss depth interval became lodged between the flutter valve and core tube. Core shortening (in which the actual core length retrieved is less than the depth of sediment penetration) primarily involves deficient entry of sediment into the core tube during core tube penetration. Physically, sediment friction against the inside wall of the core tube causes thinning of the core by lateral extrusion in front of the core tube. As the friction changes with depth, not all sediment layers may be uniformly represented in the sample (Blomqvist 1991).

The Vibrocorer demonstrated its ability to consistently collect sediment samples in the 0- to 4- and 6- to 12-inch bss depth intervals at all locations in S1A1. As discussed in Section 7.1.1.1, the actual number of attempts required to collect the specified volume of sediment in these depth

intervals did not exceed the expected number at any sampling locations. However, the sampler could not collect cores longer than 4.4 feet. The Vibrocorer's difficulty in collecting sediment in the 4- to 6-foot bss depth interval may be attributed to the sampler not being able to penetrate clay hardpan observed in the sampling area about 5 feet bss.

The Vibrocorer was unable to collect samples in S1A2, as was originally intended. The sampler was installed on the EPA GLNPO's *Mudpuppy*, which requires a minimum water depth of 3 feet for maneuvering. Because the water depth in S1A2 was only about 2 feet during the demonstration, the *Mudpuppy* was unable to enter the area.

### 7.2.3 Ability to Collect an Undisturbed Sample

During the demonstration, both the Hand Corer and Vibrocorer consistently collected sediment samples in which the sediment stratification was preserved; however, based on visual observations, the samples appeared to have been compacted. Bow wave disturbance near the sediment surface did not occur in S2A2; the water depth (0.5 to 1.5 feet) and low turbidity in this area allowed visual confirmation of the location of the sediment surface. Bow wave disturbance near the sediment surface in the remaining demonstration areas was unlikely because the speed of sampler deployment was controlled for each sampler. As mentioned above, sediment stratification was preserved for samples collected in these areas.

For both samplers, the total core length retrieved in each attempt was less than the depth of sampler deployment. The difference between the total core length retrieved and the depth of sampler deployment for the Hand Corer ranged from 15 to 25 inches in S1A2, 1 to 36 inches in S2A1, and 12 to 67 inches in S2A2. For the Vibrocorer, the difference ranged from 10.5 to 38.5 inches. As discussed above, these differences may have resulted for the reasons described in Section 7.2.2. Furthermore, these differences indicate that sampling bias might have occurred during sample collection in a given target depth interval.

### 7.2.4 Durability Based on Materials of Construction and Engineering Design

The primary components of the Hand Corer include (1) a Lexan™ nose piece; (2) a 36-inch-long, stainless-steel

core tube; (3) a stainless-steel head piece with a flutter valve; (4) two detachable, stainless-steel handles; and (5) a clevis (see Figure 5-1). Based on observations made during the demonstration, the Hand Corer is a sturdy sampler; none of the sampler components was damaged or required repair or replacement during the demonstration.

The Hand Corer was also equipped with varying lengths of galvanized-steel extension rods during the demonstration. One extension rod was used to collect samples in shallow water at S1A2 and S2A2. In both areas, no bending or bowing of the extension rod was observed. In S2A1, five extension rods were coupled together to a combined length of about 25 feet. Throughout most of the sampling in S2A1, minimal bowing of the coupled extension rods was observed during sediment penetration. During one sampling attempt in S2A1, the pontoon boat drifted after the sampler had been deployed through the 6-inch-diameter hole in the middle of the boat and had been driven into the sediment. The resulting stress on the extension rods caused one of the rods to be damaged at the threads.

The primary components of the Vibrocorer include (1) an anodized-aluminum, pressure-housed vibrohead with a terminal for an electric cable; (2) a disposable, 10-foot-long, 4-inch-diameter, plastic core tube equipped with a plastic core catcher; (3) a core tube clamp; and (4) a guide rope (see Figure 5-2). Based on observations made during the demonstration, the Vibrocorer is a sturdy sampler; none of the primary components of the sampler was damaged or required repair or replacement during the demonstration. The primary component of the Vibrocorer, the vibrohead, has an operating expectancy of about 10,000 hours. However, as discussed above, the power supply for the Vibrocorer malfunctioned during sample collection. The source of the malfunction (moisture in the control box between the power source and vibrohead) was identified and corrected by on-site personnel.

### 7.2.5 Availability of Sampler and Spare Parts

No primary component of the Hand Corer required replacement or servicing during the demonstration. Had a primary sampler component required replacement, it would not have been available in local retail stores. As discussed above, an extension rod was damaged at the threads during sampling in S2A1 and required replacement. The replacement rod was acquired within a



few hours in a local retail store. Replacement extension rods and primary sampler components may be obtained from the developer by overnight courier in 2 days or less, depending on the location of the sampling site. During sampling in S1A2, the sampling technician was able to acquire additional plastic core tube liners from the developer by overnight courier. The developer pre-cut the plastic core tube liners in response to a special request from the sampling technician. During sampling in S2A1 and S2A2, the sampling technician was able to have plastic core tube liners pre-cut at a local machine shop.

No primary component of the Vibrocorer required replacement or servicing during the demonstration. However, as discussed above, the power supply for the Vibrocorer malfunctioned and required servicing. The source of the malfunction was identified and corrected by on-site personnel within a few hours. Had on-site personnel been unable to correct the malfunction, servicing of the power supply by an off-site electrician would have been necessary. Had the vibrohead malfunctioned, it would have been packaged and shipped to the developer for servicing. Because the vibrohead is pressure-sealed, servicing of the vibrohead is not recommended in the field or by an unskilled sampling technician. Plastic core tubes for the Vibrocorer may be available from a local plastic manufacturer; however, their availability should be verified prior to a sampling event, especially one in a remote location. Core tube catchers used by GLNPO can be made from materials readily available in a hardware store.

### 7.3 Data Quality

The overall QA objective for the demonstration was to produce well-documented data of known quality. The TSAs conducted to evaluate data quality did not reveal any problems that would make the demonstration data unusable. The scope of these TSAs is described in Sections 4.3 and 4.4 of this ITVR.

This section briefly discusses the data quality of demonstration results for the reference samplers; more detailed information is provided in the DER (Tetra Tech 1999b). Specifically, the data quality associated with the field measurement activities is discussed first, followed by the data quality associated with the laboratory analysis activities.

#### 7.3.1 Field Measurement Activities

Field measurement activities conducted during the demonstration included measurement of the time associated with sample collection activities, water velocity, water depth, core length, volume of IDW, volume of sediment collected in a given sampling attempt, and depth of sampler deployment. Of these measurement parameters, specific acceptance criteria were set for the precision associated with the time and water velocity measurements only (EPA 1999). All time and water velocity measurements made during the demonstration met their respective criteria (see Table 6-7). Of the remaining parameters, some difficulties were encountered in measuring the volume of sediment collected in a given sampling attempt and the depth of sampler deployment, which are discussed below.

To measure the volume of sediment collected in a given sampling attempt, the sediment sample was transferred into a 2-L container graduated in increments of 20 mL. The container was tapped on a hard surface to minimize the presence of void spaces in the sample, the sample surface was made even using a spoon, and the volume of the sample was measured. However, because the void spaces could not be completely eliminated, the volumetric measurements are believed to have a positive bias that resulted in overestimation of PSRs. Because the total volume of the void spaces could not be measured, its impact on the PSR results could not be quantified. However, because the same volumetric measurement procedure was used for both the innovative and reference samplers, the PSR results could still be compared.

The depth of sampler deployment was measured with reference to the sediment surface. To identify the location of the sediment surface, the sampling technicians lowered the sampler into the water and used the bottom end of the sampler to feel the sediment surface. Subsequently, the technicians drove the sampler into the sediment to a depth that they estimated to be appropriate to collect a sediment sample in the specified depth interval. For the Vibrocorer in S1A1, this approach resulted in an average core length that was about 23 percent shorter than the estimated depth of sampler deployment, indicating that the sampling technicians may have had difficulty assessing the location of the sediment surface. For the Hand Corer in the remaining three areas, the average core length retrieved was shorter than the

estimated depth of sampler deployment, again indicating that the sampling technicians may have had difficulty assessing the location of the sediment surface. Specifically, for the Hand Corer in S1A2, S2A1, and S2A2, the average core length was shorter than the estimated depth of sampler deployment by 52, 41, and 78 percent, respectively. Although both the innovative and reference samplers used in the demonstration are end-filling samplers that do not collect uncompressed sediment samples, the degree of sediment sample compaction in the core tube varied depending on the sampler used. In addition, core shortening, which would impact the ability of the samplers to uniformly sample the sediment in a given depth interval, occurs to a different degree depending on the sampler used. For these reasons, conclusions drawn from a comparison of the sediment characteristics of the samples collected by the reference samplers with those of the samples collected by the Split Core Sampler should be carefully interpreted.

### 7.3.2 Laboratory Analysis Activities

The laboratory analyses conducted for the demonstration included the following: (1) PCB, arsenic, and PSD analyses of sediment samples and (2) PCB and arsenic analyses of equipment rinsate samples. To evaluate the data quality of the laboratory analysis results, field-generated QC samples, PE samples, and laboratory QC check samples were analyzed. The field-generated QC samples included the field replicates and temperature blanks described in Section 4.3 of this ITVR. The PE samples and laboratory QC check samples are described in Section 4.4. The acceptance criteria for the QC samples are presented in Table 6-7.

All temperature blanks and field replicates subjected to PCB and arsenic analyses met the acceptance criteria, indicating that the sample homogenization procedure (field replicates) and sample preservation procedure (temperature blanks) implemented in the field met the demonstration requirements. However, as stated in Section 7.1.3, in a few cases the results of field triplicate sample analyses for PSD did not meet the acceptance criterion. Despite the failures to meet the acceptance criterion, the PSD results are considered to be valid for the reasons detailed in Section 7.1.3.

The PE sample results for both PCB and arsenic analyses met the acceptance criteria, indicating that the analytical laboratory accurately measured PCBs and arsenic.

The analytical results for all laboratory QC check samples except the following met the acceptance criteria: (1) MS/MSD samples for analysis for PCBs in the sediment matrix and (2) equipment rinsate samples for PCB analysis. These issues and their likely impact on data quality are discussed below.

For the sediment matrix, in all MS/MSD samples analyzed for PCBs, Aroclor 1016 was recovered at levels higher than the upper limit of the acceptance criterion, indicating a positive bias in the PCB results for sediment samples. However, the analytical laboratory had no problem meeting the acceptance criteria for control samples such as BS/BSDs. For this reason, the failure to meet the acceptance criterion for MS/MSD sample analysis was attributed to matrix interference. Because Aroclor 1016 was recovered at levels higher than the upper limit of the acceptance criterion in all MS/MSD samples associated with both the innovative and reference samplers, the PCB results could still be compared. The MS/MSD spiking compounds (Aroclors 1016 and 1260) were selected based on the Aroclors detected during the predemonstration investigation and as recommended in SW-846 Method 8082.

Also for the sediment matrix, in one out of three MS/MSD pairs analyzed for PCBs, Aroclor 1260 was recovered at a level less than the lower limit of the acceptance criterion in the MS sample, but the recovery in the associated MSD sample was acceptable. Because the investigative samples contained only Aroclor 1242, of the two spiking compounds used to prepare the MS/MSD samples, only the Aroclor 1016 recoveries were considered to be relevant based on the PCB congener distribution; the Aroclor 1260 recoveries were not considered to be relevant. Therefore, the low recovery associated with Aroclor 1260 had no impact on data quality.

In all equipment rinsate samples analyzed for PCBs, decachlorobiphenyl (the surrogate) was recovered at levels lower than the lower limit of the acceptance criterion, indicating a negative bias in the PCB results for equipment

---

rinsate samples. However, the analytical laboratory had no problem meeting the acceptance criteria for control samples such as PE samples and deionized water blanks. For this reason, the failure to meet the surrogate recovery acceptance criterion for the equipment rinsate sample

analysis was attributed to matrix interference. Because the surrogate was recovered at levels lower than the lower limit of the acceptance criterion in all equipment rinsate samples associated with both the innovative and reference samplers, the PCB results could still be compared.

---

## Chapter 8 Economic Analysis

As discussed throughout this ITVR, the Split Core Sampler was demonstrated at two sites, each consisting of two areas. This chapter presents an economic analysis of sediment sample collection using the Split Core Sampler in two of the four demonstration areas: (1) a river mouth contaminated with PCBs (S1A1) and (2) a lake contaminated with arsenic (S2A1). These areas were selected for the economic analysis because the varied sampling conditions in these areas provide a range of costs involved in conducting sediment sampling using the Split Core Sampler. For example, during the demonstration in S1A1, the water depth was about 5 to 6 feet, and sediment samples were collected in two depth intervals: 0 to 4 and 6 to 12 inches bss. On the other hand, in S2A1, the water depth was about 18 feet, and sediment samples were collected in two depth intervals: 0 to 4 and 10 to 30 inches bss.

The purpose of this economic analysis is to estimate the costs of using the Split Core Sampler to collect sediment samples in environments similar to S1A1 and S2A1. The analysis is based on the results of the demonstration, unit costs in published cost data sources, and costs provided by the technology developers or equipment vendors.

This chapter provides information on the issues and assumptions involved in the economic analysis (Section 8.1), discusses the costs associated with using the Split Core Sampler (Section 8.2), discusses the costs associated with using the reference samplers (Sections 8.3 and 8.4), and presents a comparison of the economic analysis results for the Split Core Sampler and reference samplers (Section 8.5).

### 8.1 Issues and Assumptions

Several factors affect sediment sampling costs. In this economic analysis, wherever possible, these factors are identified such that decision-makers can independently complete a site-specific economic analysis. Costs included in the analysis are divided into four categories: sampler, labor, IDW disposal, and support equipment costs. The issues and assumptions associated with these categories and the costs not included in this analysis are briefly discussed below.

#### 8.1.1 Sampler Costs

Sampler costs include the costs of samplers and associated equipment used during the demonstration, such as extension rods and core tube liners, as applicable. These costs were provided by the technology developers or equipment vendors.

#### 8.1.2 Labor Costs

Labor costs cover the time required for sampler setup, sample collection, sampler disassembly, and sampler decontamination. In this analysis, the actual amount of time required for sample collection activities during the demonstration is used as the labor requirement, and all labor times are rounded off to the nearest half-hour. Because it may not be feasible to hire sampling technicians for a fraction of a day, a site-specific analysis should consider the local availability of such technicians and modify labor cost estimates accordingly. In this analysis, an hourly rate of \$13.51 is used for a technician (R.S. Means Company [Means] 1999), and a multiplication factor of 2.5 is applied to labor costs in

order to account for general and administrative and overhead costs. Thus, an hourly rate of \$34 is used for a technician.

### 8.1.3 IDW Disposal Costs

IDW disposal costs cover disposal of unused sediment and spent core tube liners. Unused sediment was assumed to be a nonhazardous waste because during the demonstration, the sediment PCB concentrations in S1A1 did not exceed 3.7 parts per million, and wastes containing PCB concentrations less than 50 parts per million can be disposed of as nonhazardous waste (40 *Code of Federal Regulations* [CFR] 761). Similarly, arsenic-contaminated wastes that are not listed wastes with toxicity characteristic leaching procedure (TCLP) extract concentrations less than 5 milligrams per liter (mg/L) can be disposed of as nonhazardous waste (40 CFR 261). During the demonstration, the maximum and average arsenic concentrations in sediment in S2A1 were 300 and 70 mg/kg, respectively. Based on the average arsenic concentration and the dilution factor (20) associated with the TCLP, the TCLP extract concentration for the sediment waste generated during the demonstration was estimated to be about 3.5 mg/L. Therefore, unused sediment in S2A1 was also assumed to be a nonhazardous waste.

During the demonstration, insignificant quantities of sediment were present on the spent core tube liners. Therefore, the spent core tube liners were also assumed to be a nonhazardous waste. Also, as shown in Table 8-1, the samplers generated different quantities of IDW in each demonstration area. However, the volume of IDW generated by each sampler in each area was less than 55 gallons. Because the cost to package, load, transport, and dispose of smaller containers is generally the same as the cost to perform these activities for one 55-gallon drum, it is assumed that the IDW in each area would be collected in a 55-gallon drum. As a result, the cost for IDW disposal is the same for each sampler. However, if larger numbers of samples were to be collected and the resulting IDW volume were larger, differences in IDW disposal costs among samplers would become apparent. The cost to package, load, transport, and dispose of one 55-gallon drum of nonhazardous waste is \$182 (Means 1999).

### 8.1.4 Support Equipment Costs

Support equipment includes equipment used for sampler preparation, sample extrusion, and other activities associated with sample collection. Examples of support equipment are a tripod-mounted winch and an electrical power generator.

**Table 8-1. Comparison of Investigation-Derived Waste Quantities Generated by Split Core Sampler and Reference Samplers**

Demonstration Area	Sampler	Quantity of Investigation-Derived Waste			
		Unused Sediment (liters)	Number of Core Tubes	Number of Core Tube Liners	Number of Core Tube Liner End Caps
S1A1 (river mouth)	Split Core Sampler	3	Not applicable	9 <sup>b</sup>	18
	Vibrocorer	45	5 <sup>a</sup>	Not applicable	Not applicable
S2A1 (lake)	Split Core Sampler	7	Not applicable	52 <sup>c</sup>	104
	Hand Corer	12	Not applicable	41 <sup>d</sup>	Not applicable

Notes:

- <sup>a</sup> 10-foot-long, 4-inch-diameter, plastic core tubes
- <sup>b</sup> 18-inch-long, 2-inch-diameter, plastic core tube liners
- <sup>c</sup> 36 6-inch-long, 2-inch-diameter, plastic core tube liners and 16 36-inch-long, 2-inch-diameter, plastic core tube liners
- <sup>d</sup> 36-inch-long, 2-inch-diameter, plastic core tube liners

### 8.1.5 Costs Not Included

Items whose costs are not included in this analysis are identified below along with a rationale for the exclusion of each.

**Oversight of Sampling Activities.** A typical user of a sampler would not be required to pay for customer oversight of sample collection. EPA representatives audited all activities associated with sample collection during the demonstration, but costs for EPA oversight are not included in this analysis because they are project-specific and not sampler-dependent. In addition, if physical characterization of sediment samples is required to be performed in the field, a soil scientist may be necessary. However, costs for such oversight are not included in this analysis because they are project-specific and not sampler-dependent.

**Health and Safety Personnel.** Health and safety personnel are required to be present during hazardous waste site operations, but they are not directly involved in sample collection activities.

**Analyses of Samples Collected.** Analytical costs can vary greatly depending on site-specific contaminants and are not directly related to sample collection costs.

**Personal Protective Equipment.** The type of personal protective equipment required can vary greatly depending on site-specific contamination and hazards, and the cost of such equipment is not sampler-dependent.

**Disposal of Decontamination Water.** Decontamination water may frequently be disposed of without incurring additional costs (as was the case during the demonstration).

**Travel and Per Diem for the Sampling Team.** Members of the sampling team may be available locally. For the demonstration, the sampling team consisted of both local and nonlocal staff. Because the availability of sampling team members is a function of the geographic location of the sampling site and does not depend on the samplers, travel and per diem costs for the sampling team are not included in this analysis.

**Boat Rental.** A boat may or may not be necessary for sediment sampling, depending on site conditions and the

sampler chosen. Because the cost of boat rental is not included in this analysis, other costs associated with using a boat, such as fuel costs, are also not included.

**Time Spent in Maneuvering the Sampling Platform.** The time required to maneuver the sampling platform varies greatly depending on site conditions such as water depth and weather. For example, when the wind velocity was high during the demonstration, a significant amount of time was spent maneuvering the EPA GLNPO's *Mudpuppy* (in S1A1) and the pontoon boat (in S2A1); as a result, the sampling sometimes had to be discontinued for the day. Because these delays were not sampler-dependent, the time spent in maneuvering the sampling platforms is not included in this analysis.

**Time Spent in Managing the Samples.** The time required to homogenize the sediment, fill and label sample containers, prepare sample containers for shipment, fill out chain-of-custody forms, and ship the samples varies greatly depending on the number of samples collected and site location. Therefore, the time spent in managing the samples is not included in this analysis because it is project-specific and not sampler-dependent.

**Mobilization and Demobilization.** Mobilization and demobilization costs vary greatly depending on the site location and conditions. For the demonstration, mobilization and demobilization activities were mainly associated with procuring sampling platforms and setting up sample management areas. The sampling platforms used were selected based on their availability but not necessarily based on sampler requirements. For example, in S1A1, the EPA GLNPO's *Mudpuppy* was used because it was available free of charge from EPA Region 5. Also, two tents were set up for sample management in S1A1 and S2A1 to avoid delays resulting from inclement weather but not based on sampler requirements. Therefore, mobilization and demobilization costs are not included in this analysis.

**Commonly Available Support Equipment.** The cost of support equipment that is commonly available and likely would not be purchased specifically for sampling is not included in this analysis. For example, the cost of wrenches and tape measures is not included in this analysis because it is assumed that a field sampling team would already have such tools as part of its field sampling gear.

**Support Equipment That Costs Less Than \$10.** The cost of inexpensive support equipment, such as stainless-steel spoons and mixing bowls used to homogenize sediment samples is not included in this analysis. In addition, the cost of fuel consumed to operate support equipment such as a generator is not included because, based on the fuel consumed during the demonstration, the fuel cost was estimated to be less than \$10.

## 8.2 Split Core Sampler Costs

This section presents information on sampler, labor, IDW disposal, and support equipment costs for the Split Core Sampler as well as a summary of these costs. Table 8-2 presents these costs.

### 8.2.1 Sampler Cost

In S1A1, AMS used the Split Core Sampler kit (\$524) as well as one 6-inch-long core tube (\$211); one core tube coupling (\$72.50); one AMS rubber-coated cross handle (\$31); nine 18-inch-long, plastic core liners (\$6 each); nine pairs of core liner end caps (\$0.21 per pair); two 4-foot-long, stainless-steel extension rods (\$69 each); and one 3-foot-long, stainless-steel extension rod (\$67). The sampler kit contained a 12-inch-long core tube; top cap; coring tip; basket retainer; 12-inch-long, plastic liner; and slip wrench. The total sampler cost for S1A1 was estimated to be \$1,097.50. The total sampler cost shown in Table 8-2 does not include the cost of end caps because the total cost of the end caps used was less than \$10.

In S2A1, AMS used the Split Core Sampler kit (\$524) as well as one 6-inch-long core tube (\$211); two additional, 12-inch-long core tubes (\$229 each); two core tube couplings (\$72.50 each); one AMS rubber-coated cross handle (\$31); 36 6-inch-long, plastic core tube liners (\$2 each); 16 36-inch-long, plastic core liners (\$9 each); 52 pairs of core liner end caps (\$0.21 per pair); one 3-foot-long, stainless-steel extension rod (\$67); four 4-foot-long, stainless-steel extension rods (\$69 each); and two 4-foot-long, carbon-steel extension rods (\$48.50 each). The total sampler cost for S2A1 was estimated to be \$2,036.

### 8.2.2 Labor Cost

In S1A1, the time for sampler setup, sample collection, sampler disassembly, and sampler decontamination totaled 68 minutes or about 1 hour for one technician. In this

area, five investigative samples each were collected in the 0- to 4- and 6- to 12-inch bss depth intervals using the Split Core Sampler. Table 4-3 presents additional information on the total number of samples collected. The labor cost for sampling in S1A1 was estimated to be \$34.

In S2A1, the time for sampler setup, sample collection, sampler disassembly, and sampler decontamination totaled 639 minutes or about 11 hours for one technician. In this area, 15 investigative samples each were collected in the 0- to 4- and 10- to 30-inch bss depth intervals using the Split Core Sampler. The labor cost for sampling in S2A1 was estimated to be \$374. When field technicians work more than 8 hours in 1 day, overtime costs may be incurred. In this estimate, however, no overtime costs are included.

### 8.2.3 IDW Disposal Cost

Sampling in S1A1 generated IDW consisting of 3 L of unused sediment, 9 core liners, and 18 end caps. The cost for disposal of one 55-gallon drum of nonhazardous waste is \$182.

Sampling in S2A1 generated IDW consisting of 7 L of unused sediment, 52 core liners, and 104 end caps. The cost for disposal of one 55-gallon drum of nonhazardous waste is \$182.

### 8.2.4 Support Equipment Cost

Support equipment used during Split Core Sampler sampling in S1A1 included one electric hammer (with a rental cost of \$40 per day [Wirtz Rentals Co. 1999]), an SDS Max self-locking adapter for attaching the electric hammer to the top extension rod (\$90 [Tetra Tech 1999a]), one sample extrusion rod (\$25 [Tetra Tech 1999a]), two slip wrenches, one carbon-steel bristled brush, and one stainless-steel bristled brush. The costs of the slip wrenches and brushes are not included in this analysis because a field sampling team would already have such tools as part of its field sampling gear. The total cost for support equipment for S1A1 is \$155.

Support equipment used during Split Core Sampler sampling in S2A1 included one electric hammer (with a rental cost of \$40 per day [Wirtz Rentals Co. 1999]), an SDS Max self-locking adapter for attaching the electric hammer to the top extension rod (\$90 [Tetra Tech 1999a]),

**Table 8-2. Split Core Sampler Cost Summary**

Item	Quantity	Unit Cost (\$)	Total Cost (\$)
<b>S1A1 (River Mouth) Costs</b>			
<b>Sampler</b>			
Split Core Sampler kit	1 unit	524	524
6-inch-long core tube	1 unit	211	211
Core tube coupling	1 unit	72.50	72.50
AMS rubber-coated cross handle	1 unit	31	31
18-inch-long, plastic core liners <sup>a</sup>	9 units	6	54
3-foot-long, stainless-steel extension rod	1 unit	67	67
4-foot-long, stainless-steel extension rods	2 units	69	138
Labor	1 hour	34	34
IDW disposal	1 55-gallon drum	182	182
<b>Support equipment</b>			
Electric hammer	1 unit for 1 day	40	40
Electric hammer adapter	1 units	90	90
Sample extrusion rod	1 unit	25	25
<b>Total<sup>b</sup></b>			<b>\$1,470</b>
<b>S2A1 (Lake) Costs</b>			
<b>Sampler</b>			
Split Core Sampler kit	1 unit	524	524
6-inch-long core tube	1 unit	211	211
12-inch-long core tubes	2 units	229	458
Core tube coupling	2 units	72.50	145
AMS rubber-coated cross handle	1 unit	31	31
6-inch-long, plastic core liners <sup>a</sup>	36 units	2	72
36-inch-long, plastic core liners <sup>a</sup>	16 units	9	144
Liner end caps <sup>a</sup>	52 pairs	0.21	11
3-foot-long, stainless-steel extension rods	1 unit	67	67
4-foot-long, stainless-steel extension rods	4 units	69	276
4-foot long, carbon-steel extension rods	2 units	48.50	97
Labor	11 hours	34	374
IDW disposal	1 55-gallon drum	182	182
<b>Support equipment</b>			
Electric hammer	1 unit for 2 days	40	80
Electric hammer adapter	1 unit	90	90
Generator	1 unit for 2 days	20	40
Tripod-mounted winch	1 unit for 3 days	28	84
<b>Total<sup>b</sup></b>			<b>\$2,890</b>

Notes:

AMS = Art's Manufacturing & Supply, Inc.

IDW = Investigation-derived waste

<sup>a</sup> Consumable supplies

<sup>b</sup> The total dollar amount is rounded to the nearest \$10.

a generator (with a rental cost of \$20 per day), one AMS tripod-mounted winch (with a rental cost of \$28 per day [Tetra Tech 1999a]), two slip wrenches, one carbon-steel bristled brush, and one stainless-steel bristled brush. The

costs of the slip wrenches and brushes are not included in this analysis because a field sampling team would already have such tools as part of its field sampling gear. The total cost for support equipment for S2A1 is \$294.



### 8.2.5 Summary of Split Core Sampler Costs

In summary, for the Split Core Sampler, the costs to collect the number of samples listed in Table 4-3 for the top two depth intervals in S1A1 and both depth intervals in S2A1 were estimated to be \$1,470 and \$2,890 for S1A1 and S2A1, respectively. This economic analysis shows that most of the total cost (about 70 to 75 percent) was associated with the purchase of samplers. The remaining total cost was associated with labor, IDW disposal, and support equipment costs.

## 8.3 Hand Corer Costs

This section presents information on sampler, labor, IDW disposal, and support equipment costs for the Hand Corer as well as a summary of these costs. Table 8-3 presents these costs.

### 8.3.1 Sampler Cost

The Hand Corer purchase cost was approximately \$329. During the demonstration, 41 core tube liners and five 5-foot-long, galvanized-steel extension rods were used in S2A1. Liners were purchased in four packages of 12 at a cost of \$192 per package. The purchase cost of

each extension rod was \$93. The total sampler cost was estimated to be \$1,562.

### 8.3.2 Labor Cost

In S2A1, the time required for sampler setup, sample collection, sampler disassembly, and sampler decontamination totaled 594 minutes or about 10 hours for each of two technicians. In addition, to facilitate sample extrusion, 41 core tube liners were cut at a local machine shop at a cost of \$3 each, for a total cost of \$123. In this area, 15 investigative samples each were collected in the 0- to 4- and 10- to 30-inch bss depth intervals using the Hand Corer. Table 4-3 presents additional information on the total number of samples collected. The labor cost for sampling was estimated to be \$803. When field technicians work more than 8 hours in one day, overtime costs may be incurred. This estimate, however, includes no overtime costs.

### 8.3.3 IDW Disposal Cost

Sampling in S2A1 generated IDW consisting of 12 L of unused sediment and 41 core tube liners. The total volume of IDW generated was less than 55 gallons. The cost for disposal of one 55-gallon drum of nonhazardous waste is \$182.

**Table 8-3. Hand Corer Cost Summary for S2A1 (Lake)**

Item	Quantity	Unit Cost (\$)	Total Cost (\$)
<b>Sampler</b>			
Hand Corer	1 unit	329	329
Core tube liners <sup>a</sup>	4 dozen	192	768
Galvanized-steel extension rods	5 units	93	465
<b>Labor</b>			
Technicians	20 hours	34	680
Cut liners	41 units	3	123
IDW disposal	1 55-gallon drum	182	182
<b>Support equipment</b>			
Tripod-mounted winch	1 unit for 3 days	40	120
<b>Total<sup>b</sup></b>			<b>\$2,670</b>

Notes:

IDW = Investigation-derived waste

<sup>a</sup> Consumable supplies

<sup>b</sup> The total dollar amount is rounded to the nearest \$10.

### 8.3.4 Support Equipment Cost

Support equipment used during Hand Corer sampling included an tripod-mounted winch with telescoping legs. The tripod-mounted winch was rented for 3 days at a daily rate of \$40 (Hazco 1999). The total cost of the support equipment was estimated to be \$120.

### 8.3.5 Summary of Hand Corer Costs

In summary, for the Hand Corer, the costs to collect the number of samples listed in Table 4-3 were estimated to be \$2,670. This economic analysis shows that most of the total cost was associated with sampler purchase (59 percent) and labor (30 percent). The remaining 11 percent was associated with IDW disposal and support equipment costs.

## 8.4 Vibrocorer Costs

This section presents information on sampler, labor, IDW disposal, and support equipment costs for the Vibrocorer as well as a summary of these costs. Table 8-4 presents these costs.

### 8.4.1 Sampler Cost

The Vibrocorer purchase cost was approximately \$24,500. Also, 4-inch-diameter, 10-foot-long, plastic core tubes

were required for sample collection. During the demonstration, five tubes were used, and the purchase cost of each tube was \$25. The total sampler cost was estimated to be \$24,625. Because the Vibrocorer's purchase cost is relatively high and because the Vibrocorer is not available for rental, the Vibrocorer should be considered for sediment sampling only when the sampling program is expected to be of long duration, which will allow recovery of the sampler purchase cost.

### 8.4.2 Labor Cost

The time required for sampler setup, sample collection, sampler disassembly, and sampler decontamination totaled 142 minutes or about 2.5 hours for each of two technicians. In addition, one technician spent about 1 hour preparing core catchers at an off-site location. In S1A1, five investigative samples each were collected in the 0- to 4- and 6- to 12-inch bss depth intervals using the Vibrocorer. Table 4-3 presents additional information on the total number of samples collected. The labor cost for sampling was estimated to be \$204.

### 8.4.3 IDW Disposal Cost

Sampling in S1A1 generated IDW consisting of 45 L of unused sediment and five plastic core tubes. The total volume of IDW generated was less than 55 gallons. The cost for disposal of one 55-gallon drum of nonhazardous waste is \$182.

**Table 8-4. Vibrocorer Cost Summary for S1A1 (River Mouth)**

Item	Quantity	Unit Cost (\$)	Total Cost (\$)
Sampler			
Vibrocorer	1 unit	24,500	24,500
Core tubes <sup>a</sup>	5 units	25	125
Labor	6 hours	34	204
IDW disposal	1 55-gallon drum	182	182
Support equipment			
A-frame and winches	1 unit	3,500	3,500
Drill	1 unit for 1 day	12	12
Saw	1 unit for 1 day	15	15
<b>Total<sup>b</sup></b>			<b>\$28,540</b>

Notes:

IDW = Investigation-derived waste

<sup>a</sup> Consumable supplies

<sup>b</sup> The total dollar amount is rounded to the nearest \$10.

### 8.4.4 Support Equipment Cost

Support equipment costs for the Vibrocorer included a purchase price of \$3,500 for an A-frame and two electric (12-volt direct current) winches with steel cable for raising and lowering the sampler; a 1-day rental cost of \$12 for one portable drill (Cincy Tool Rental 1999); and a 1-day rental cost of \$15 for one portable circular saw (Falls Tool Rental 1999). Two 3/4-inch socket wrenches, each costing less than \$10, were also used. The total cost of the support equipment was estimated to be \$3,527.

### 8.4.5 Summary of Vibrocorer Costs

In summary, for the Vibrocorer, the costs to collect the number of samples listed in Table 4-3 for the top two depth intervals in S1A1 were estimated to be \$28,540. This economic analysis shows that most of the total cost was associated with sampler purchase (86 percent). The remaining 14 percent was associated with labor, IDW disposal, and support equipment costs.

## 8.5 Comparison of Economic Analysis Results

The costs for each sampler used in S1A1 and S2A1 are summarized in Table 8-5. For S1A1, the total costs for the

Split Core Sampler were about 95 percent less than the costs for the reference sampler, the Vibrocorer. This difference was due mainly to the costs involved in purchasing the samplers. However, costs that were dependent on the number of samples collected or the amount of time required (which is itself dependent on the number of samples collected), such as labor and support equipment costs, were also higher for the Vibrocorer.

For S2A1, the total costs for the Split Core Sampler were 8 percent higher than the costs for the reference sampler, the Hand Corer. The sampler cost for the Split Core Sampler was about 30 percent higher than that for the Hand Corer. The labor cost for the Hand Corer was about twice that for the Split Core Sampler, primarily because two technicians were used to operate the Hand Corer while only one technician was used to operate the Split Core Sampler. Finally, the support equipment cost for the Split Core Sampler was about two times higher than that for the Hand Corer, primarily because the Split Core Sampler required an electric generator, electric hammer, and electric hammer adapter.

**Table 8-5. Comparison of Costs for Split Core Sampler and Reference Samplers**

Item	S1A1 (River Mouth)		S2A1 (Lake)	
	Split Core Sampler	Vibrocorer	Split Core Sampler	Hand Corer
Sampler	\$1,097.50	\$24,625	\$2,036	\$1,562
Labor	34	204	374	803
IDW disposal	182	182	182	182
Support equipment	155	3,527	294	120
<b>Total<sup>a</sup></b>	<b>\$1,470</b>	<b>\$28,540</b>	<b>\$2,890</b>	<b>\$2,670</b>

Notes:

IDW = Investigation-derived waste

<sup>a</sup> Each total dollar amount is rounded to the nearest \$10.

## Chapter 9

### Summary of Demonstration Results

As discussed throughout this ITVR, the Split Core Sampler was demonstrated at two sites in EPA Regions 1 and 5. At the Region 1 site, the Split Core Sampler was demonstrated in two areas: a lake (S2A1) and a wetland (S2A2). At the Region 5 site, the Split Core Sampler was also demonstrated in two areas: a river mouth (S1A1) and a freshwater bay (S1A2). Collectively, the four areas provided a variety of sampling conditions such as different water depths, sediment types, sediment contaminant characteristics, and sediment thicknesses necessary to properly evaluate the sampler. Based on the predemonstration investigation results, demonstration objectives, and site support facilities available, (1) the Hand Corer was selected as the reference sampler for S1A2, S2A1, and S2A2, and (2) the Vibrocorer was selected as the reference sampler for S1A1.

This chapter compares the performance and cost results for the Split Core Sampler with those for the reference samplers. Tables 9-1 and 9-2 summarize the demonstration results for the primary and secondary objectives, respectively. As shown in these tables, both the Split Core Sampler and the reference samplers were unable to collect samples in the deep depth interval (4 to 11 feet bss). Key demonstration findings are summarized below for the primary and secondary objectives.

#### 9.1 Primary Objectives

Key demonstration findings are summarized below for primary objectives P1 through P7.

- P1. In the shallow depth interval (0 to 4 inches bss), to collect a specified number of samples, the Split Core Sampler required 7 percent more attempts than expected (46 actual versus 43 expected), whereas the reference samplers required 14 percent more attempts than expected (49 actual versus 43 expected).
- P1. In the moderate depth interval (4 to 32 inches bss), the Split Core Sampler required 38 percent more attempts than expected (40 actual versus 29 expected), but the reference samplers required 156 percent more attempts than expected (64 actual versus 25 expected).
- P1. For the shallow depth interval, mean PSRs ranging from 89 to 100 were achieved by the Split Core Sampler, whereas the reference samplers' mean PSRs ranged from 85 to 100. The variation in PSRs as measured by their RSDs ranged from 0 to 26 percent for the Split Core Sampler, whereas the reference samplers' RSDs ranged from 0 to 33 percent.
- P1. For the moderate depth interval, mean PSRs ranging from 37 to 100 were achieved by the Split Core Sampler, whereas the reference samplers' mean PSRs ranged from 21 to 82. The RSDs for the Split Core Sampler ranged from 0 to 51 percent, whereas the reference samplers' RSDs ranged from 3 to 161 percent.
- P2. For the shallow depth interval, the Split Core Sampler's actual core lengths equaled the target core length in 96 percent of the total sampling attempts. The reference samplers' actual core lengths equaled the target core length in 94 percent of the total sampling attempts.

**Table 9-1. Summary of Results for Primary Objectives**

Primary Objective	Evaluation Criterion	Sampling Depth Interval/ Demonstration Area <sup>a</sup>	Performance Results	
			Split Core Sampler	Reference Sampler <sup>b</sup>
P1 Ability to consistently collect a specified volume of sediment	Actual versus expected number of sampling attempts	Shallow (0 to 4 inches bss)/S1A1, S1A2, and S2A1	46 actual attempts versus 43 expected attempts (7% more than expected)	49 actual attempts versus 43 expected attempts (14% more than expected)
		Moderate (4 to 32 inches bss)/S1A1, S1A2, S2A1, and S2A2	40 actual attempts versus 29 expected attempts (38% more than expected)	64 actual attempts versus 25 expected attempts (156% more than expected)
		Deep (4 to 11 feet bss)/S1A1 and S2A2	Not applicable <sup>c</sup>	Unable to collect samples <sup>c</sup>
	Volume of sediment sampled versus design volume	Shallow (0 to 4 inches bss)/S1A1, S1A2, and S2A1	Mean PSRs: 89 to 100 RSDs of PSRs: 0 to 26%	Mean PSRs: 85 to 100 RSDs of PSRs: 0 to 33%
		Moderate (4 to 32 inches bss)/S1A1, S1A2, S2A1, and S2A2	Mean PSRs: 37 to 100 RSDs of PSRs: 0 to 51%	Mean PSRs: 21 to 82 RSDs of PSRs: 3 to 161%
		Deep (4 to 11 feet bss)/S1A1 and S2A2	Not applicable <sup>c</sup>	Unable to collect samples <sup>c</sup>
P2 Ability to consistently collect sediment in a specified depth interval	Number of sampling attempts in which actual core length equaled target core length	Shallow (0 to 4 inches bss)/S1A1, S1A2, and S2A1	44 of 46 attempts (96%)	46 of 49 attempts (94%)
		Moderate (4 to 32 inches bss)/S1A1, S1A2, S2A1, and S2A2	14 of 36 attempts (39%)	8 of 64 attempts (13%)
		Deep (4 to 11 feet bss)/S1A1 and S2A2	Not applicable <sup>c</sup>	Unable to collect samples <sup>c</sup>
P3 Ability to collect samples with consistent characteristics from a homogenous layer of sediment	Variability of sample characteristics in terms of PSD	0 to 4 inches bss/S2A1	Sand: 29 to 42% Silt: 49 to 59% Clay: 8 to 10%	Sand: 26 to 46% Silt: 48 to 72% Clay: 0 to 5%
		10 to 30 inches bss/S2A1	Sand: 25 to 42% Silt: 50 to 67% Clay: 6 to 10%	Sand: 35 to 43% Silt: 53 to 62% Clay: 0 to 4%
		12 to 32 inches bss/S1A2	Sand: 2 to 5% Silt: 66 to 74% Clay: 23 to 31%	Sand: 3 to 6% Silt: 63 to 72% Clay: 22 to 31%
P4 Ability to collect a representative sample from a clean sediment layer below a contaminated sediment layer	Mean difference between innovative and reference sampler arsenic concentrations for clean layer is zero	10 to 30 inches bss/S2A1	According to the Wilcoxon signed rank test, there was a 0.9 percent probability that the innovative and reference sampler arsenic concentrations were not different; at a statistical significance level of 0.05, the samples collected by the Split Core Sampler contained arsenic concentrations lower than those in the samples collected by the reference sampler (the Hand Corer). Because of the greater opportunity for sample compaction in the Split Core Sampler core tube, no conclusion could be drawn.	
P5 Ability to be adequately decontaminated	Contaminant concentrations in equipment rinsate samples are below reporting limits	Objective addressed by area: one PCB-contaminated area (S1A1) and one arsenic-contaminated area (S2A1)	The contaminant concentrations in the equipment rinsate samples for the Split Core Sampler and reference samplers were below the reporting limits (1 part per billion for PCBs and 10 parts per billion for arsenic).	

**Table 9-1. Summary of Results for Primary Objectives (Continued)**

Primary Objective	Evaluation Criterion	Sampling Depth Interval/ Demonstration Area <sup>a</sup>	Performance Results	
			Split Core Sampler	Reference Sampler <sup>b</sup>
P6 Time requirements for sample collection activities	Total time required for sampler setup, sample collection, sampler disassembly, and sampler decontamination	Objective addressed by area: S1A1	68 minutes	142 minutes
		Objective addressed by area: S1A2	45 minutes	53 minutes
		Objective addressed by area: S2A1	639 minutes	594 minutes
		Objective addressed by area: S2A2	105 minutes	165 minutes
P7 Sampling costs	Total cost, including sampler, labor, IDW disposal, and support equipment costs	Objective addressed by area: S1A1	\$1,470	\$28,540
		Objective addressed by area: S2A1	\$2,890	\$2,670

Notes:

bss = Below sediment surface	RSD = Relative standard deviation
IDW = Investigation-derived waste	S1A1 = River mouth
PCB = Polychlorinated biphenyl	S1A2 = Freshwater bay
PSD = Particle size distribution	S2A1 = Lake
PSR = Percent sample recovery	S2A2 = Wetland

<sup>a</sup> Based on the PSD results, the shallow depth interval contained silty sand in S1A1, predominantly sand and silt with some clay in S1A2, and sandy silt in S2A1. The moderate depth interval contained sandy silt in both S1A1 and S2A1, clayey silt in S1A2, and predominantly silt with some sand and clay in S2A2. Also, in S2A2, the (1) shallow and moderate depth intervals contained significant amounts of partially decomposed reeds and leaves and live vegetation and (2) deep depth interval contained peat. The sediment in the deep depth interval was not analyzed for PSD.

<sup>b</sup> The Hand Corer was used as the reference sampler in S1A2, S2A1, and S2A2. The Vibrocorer was used as the reference sampler in S1A1.

<sup>c</sup> The Split Core Sampler and the Hand Corer are not designed to collect samples in the deep depth intervals in S1A1 and S2A2. The Vibrocorer was unable to collect samples below 5 feet bss because of the presence of clay hardpan in S1A1.

**Table 9-2. Summary of Results for Secondary Objectives**

Secondary Objective	Performance Results		
	Split Core Sampler	Reference Sampler <sup>a</sup>	
		Hand Corer	Vibrocorer
S1 Skills and training requirements for proper sampler operation	<ul style="list-style-type: none"> <li>• Easy to operate; requires minimal skills and training</li> <li>• Can be operated by one person; a tripod-mounted winch is recommended when more than two extension rods are used</li> <li>• For more efficient recovery of samples, an electric hammer should be used to induce vibrations in the sampler</li> </ul>	<ul style="list-style-type: none"> <li>• Easy to operate; requires minimal skills and training</li> <li>• Can be operated by one person when up to two extension rods are used; two persons and a tripod-mounted winch are recommended when more extension rods are used</li> </ul>	<ul style="list-style-type: none"> <li>• Relatively complicated to operate; requires moderate skills and training</li> <li>• Requires two persons and a motor-operated winch because of the heaviness of the sampler (about 150 pounds)</li> </ul>
S2 Ability to collect samples under a variety of site conditions	<ul style="list-style-type: none"> <li>• Collected samples in a river mouth (S1A1), freshwater bay (S1A2), lake (S2A1), and wetland (S2A2) where water depths ranged from 0.5 foot to 18 feet</li> <li>• Collected samples in shallow (0- to 4-inch bss) and moderate (4- to 32-inch bss) depth intervals; sampler is not designed to collect samples in depth intervals below 4 feet bss</li> <li>• Collected samples from a variety of sampling platforms: wooden planks fastened to ladders, a Jon boat, a pontoon boat, and the EPA GLNPO's <i>Mudpuppy</i></li> </ul>	<ul style="list-style-type: none"> <li>• Collected samples in a freshwater bay (S1A2), lake (S2A1), and wetland (S2A2) where water depths ranged from 0.5 foot to 18 feet</li> <li>• Collected samples in shallow (0- to 4-inch bss) and moderate (4- to 32-inch bss) depth intervals; sampler is not designed to collect samples in depth intervals below 3 feet bss</li> <li>• Collected samples from a variety of sampling platforms: wooden planks fastened to ladders, a Jon boat, and a pontoon boat</li> <li>• Material caught between core tube and flutter valve could cause partial or complete loss of sample</li> </ul>	<ul style="list-style-type: none"> <li>• Collected samples in a river mouth (S1A1) where water depths ranged from 5 to 6 feet</li> <li>• Collected samples in shallow (0- to 4-inch bss) and moderate (4- to 32-inch bss) depth intervals but was unable to penetrate clay hardpan in order to collect samples in 4- to 6-foot bss depth interval</li> <li>• Collected samples from the EPA GLNPO's <i>Mudpuppy</i></li> </ul>
S3 Ability to collect an undisturbed sample	<ul style="list-style-type: none"> <li>• Collected relatively compressed core samples of both unconsolidated and consolidated sediments from the sediment surface downward, based on visual observations</li> <li>• Sediment stratification preserved for both unconsolidated and consolidated sediments</li> </ul>	<ul style="list-style-type: none"> <li>• Collected relatively compressed core samples of both unconsolidated and consolidated sediments from the sediment surface downward, based on visual observations</li> <li>• Sediment stratification preserved for both unconsolidated and consolidated sediments</li> </ul>	<ul style="list-style-type: none"> <li>• Collected relatively compressed core samples of both unconsolidated and consolidated sediments from the sediment surface downward, based on visual observations</li> <li>• Sediment stratification preserved for both unconsolidated and consolidated sediments</li> </ul>

**Table 9-2. Summary of Results for Secondary Objectives (Continued)**

Secondary Objective	Performance Results		
	Split Core Sampler	Reference Sampler <sup>a</sup>	
		Hand Corer	Vibrocorer
S3 Ability to collect an undisturbed sample (continued)	<ul style="list-style-type: none"> <li>Samples collected in and below moderate depth interval may be of questionable representativeness because of core shortening and core compression; sampler is not designed to collect samples in depth intervals below 4 feet bss</li> </ul>	<ul style="list-style-type: none"> <li>Samples collected in and below moderate depth interval may be of questionable representativeness because of core shortening and core compression; sampler is not designed to collect samples in depth intervals below 3 feet bss</li> </ul>	<ul style="list-style-type: none"> <li>Samples collected in moderate and deep depth intervals may be of questionable representativeness because of core shortening and core compression</li> </ul>
S4 Durability based on materials of construction and engineering design	<ul style="list-style-type: none"> <li>Sampler is sturdy; its primary components are made of stainless steel</li> <li>Both stainless-steel and carbon-steel extension rods are rigid; significant bowing was observed when rods were coupled to a total length of 27 feet, but the rods were not damaged</li> </ul>	<ul style="list-style-type: none"> <li>Sampler is sturdy; most of its primary components are made of stainless steel</li> <li>Galvanized extension rods are rigid; minimal bending or bowing was observed when rods were coupled to a total length of 25 feet</li> <li>During sample collection in S2A1, where water depth was about 18 feet, the pontoon boat drifted; the resulting stress damaged one extension rod at the threads</li> </ul>	<ul style="list-style-type: none"> <li>Sampler is sturdy; its primary component, the vibrohead, is made of anodized aluminum and has a life expectancy of 10,000 operating hours</li> <li>During sample collection in S1A1, the power supply for the sampler malfunctioned; the source of the malfunction was identified and corrected by on-site personnel</li> </ul>
S5 Availability of sampler and spare parts	<ul style="list-style-type: none"> <li>Sampler and its support equipment are not expected to be available in local retail stores but may be obtained from technology developer by overnight courier in 2 days or less, depending on the location of the sampling site</li> </ul>	<ul style="list-style-type: none"> <li>Primary components of sampler are not expected to be available in local retail stores but may be obtained from technology developer by overnight courier in 2 days or less, depending on the location of the sampling site ; extension rods are expected to be available in local retail stores</li> </ul>	<ul style="list-style-type: none"> <li>Primary sampler component, the vibrohead, is not available in local retail stores; because the vibrohead is pressure-sealed, if it malfunctions, it should be packaged and shipped to the developer for servicing</li> </ul>

Notes:

- bss = Below sediment surface
- EPA = U.S. Environmental Protection Agency
- GLNPO = Great Lakes National Program Office

<sup>a</sup> The Hand Corer was used as the reference sampler in S1A2, S2A1, and S2A2. The Vibrocorer was used as the reference sampler in S1A1.



- P2. For the moderate depth interval, the Split Core Sampler's actual core lengths equaled the target core length in 39 percent of the total sampling attempts. The reference samplers' actual core lengths equaled the target core length in 13 percent of the total sampling attempts.
- P3. Based on the PSD results, both the Split Core Sampler and reference samplers collected samples with consistent physical characteristics from a homogenous layer of sediment.
- P4. In sampling a clean sediment layer below a contaminated sediment layer, the Split Core Sampler and reference sampler (the Hand Corer) collected samples whose contaminant concentrations were statistically different from each other at a significance level of 0.05. Arsenic concentrations in the samples collected by the Split Core Sampler were less than those in the samples collected by the Hand Corer. However, because of the greater opportunity for sample compaction in the Split Core Sampler core tube, no conclusion could be drawn regarding the Split Core Sampler's ability to collect representative samples from a clean layer below a contaminated layer. Explanation of this result was beyond the scope of the demonstration.
- P5. Both the Split Core Sampler and reference samplers demonstrated the ability to be adequately decontaminated after sampling in areas contaminated with either PCBs or arsenic.
- P6. Compared to the reference samplers, the Split Core Sampler reduced sampling time by 15 to 52 percent in three of the four areas sampled but increased the sampling time by 10 percent in the remaining area.
- P7. Sampling costs were estimated for two of the four areas sampled. In one area, the sampling costs for the Split Core Sampler were 95 percent less than those for the reference sampler (the Vibrocorer); in the other area, the sampling costs for the Split Core Sampler were 8 percent greater than those for the reference sampler (the Hand Corer).

## 9.2 Secondary Objectives

Key demonstration findings are summarized below for secondary objectives S1 through S5.

- S1. The Split Core Sampler, like the Hand Corer, is easy to operate and requires minimal skills and training. However, operation of the Vibrocorer is relatively complicated and requires moderate skills and training.
- S1. The Split Core Sampler was operated by one person, whereas the Hand Corer was operated by one or two persons and the Vibrocorer was operated by two persons. When more than two extension rods were required, both the Split Core Sampler and Hand Corer were operated using a tripod-mounted winch. Vibrocorer operation required a motor-operated winch because of the heaviness of the sampler.
- S1. For more efficient recovery of samples, an electric hammer should be used to induce vibrations in the Split Core Sampler; a 110-volt power supply is required to operate the electric hammer. The Vibrocorer requires a three-phase, 230- or 440-volt, 50- to 60-hertz power supply, which may be a sampler limitation if the power supply fails. The Hand Corer does not require any power supply.
- S2. Both the Split Core Sampler and reference samplers collected samples in shallow and moderate depth intervals in all demonstration areas. No sampler was able to collect samples in deep depth intervals (4 to 11 feet bss).
- S3. Based on visual observations, both the Split Core Sampler and reference samplers collected partially compressed core samples of consolidated and unconsolidated sediments from the sediment surface downward. Samples collected by both the Split Core Sampler and reference samplers in moderate and deep depth intervals may be of questionable representativeness because of core shortening and core compression.

- 
- S3. Sediment stratification was preserved for both consolidated and unconsolidated sediments in the samples collected by the Split Core Sampler and reference samplers.
- S4. Based on their materials of construction and engineering designs, both the Split Core Sampler and reference samplers are considered to be sturdy.
- S5. The Split Core Sampler and its support equipment are not expected to be available in local retail stores. Similarly, the primary components of the Hand Corer and Vibrocorer are not expected to be available in local retail stores; extension rods for the Hand Corer may be locally available.

## Chapter 10 References

- Aaby, B., and G. Digerfeldt. 1986. "Sampling Techniques for Lakes and Bogs." Chapter 8 in *Handbook of Holocene Palaeoecology and Palaeohydrology*. B.E. Berglund, Editor. John Wiley & Sons, New York.
- Analytical Software. 1996. Statistix<sup>®</sup> for Windows. Version 2.0. Tallahassee, Florida.
- ASTM. 1998. "ASTM Standards in Building Codes." Volume 3. C 962-D 2940.
- Belokopytov, I.E., and V.V. Beresnevich. 1955. "Giktorf's Peat Borers." *Torfyanaya Promyflennost*. Number 8. Pages 9 and 10.
- Blomqvist, S. 1991. "Quantitative Sampling of Soft-Bottom Sediments: Problems and Solutions." *Marine Ecology Progress Series*. Volume 72. Pages 295 through 304.
- Cincy Tool Rental. 1999. "Electric Tools." On-Line Address: <http://www.cincytool.com/cgi-bin/hackmail4.cgi?electric>. Accessed on August 4.
- Downing, J.A. 1984. "Sampling the Benthos of Standing Waters." Chapter 4 in *Manual on Methods for the Assessment of Secondary Productivity in Fresh Waters*. J.A. Downing and F.H. Rigler, Editors. Blackwell Scientific Publications. Oxford, England.
- Environment Canada. 1994. "Guidance Document on Collection and Preparation of Sediment for Physicochemical Characterization and Biological Testing." Environmental Protection Series. Report EPS 1/RM/29. December.
- EPA. 1996. "Test Methods for Evaluating Solid Waste." Volumes 1A through 1C. SW-846. Third Edition. Update III. OSWER. Washington, DC. December.
- EPA. 1999. "Sediment Sampling Technologies Demonstration Plan." ORD. Washington, DC. April.
- Faegri, K., and J. Iversen. 1989. *Textbook of Pollen Analysis*. Knut Faegri, Peter Emil Kaland, and Knut Krzywinski, Editors. Fourth Edition. Pages 60 through 63.
- Falls Tool Rental. 1999. "Power Tool Rental Rates." On-Line Address: <http://www.fallstoolrental.com/powertools.html>. Accessed on August 4.
- Gilbert, R. 1987. *Statistical Methods for Environmental Pollution Monitoring*. Van Nostrand Reinhold Company, Inc. New York.
- Hazco. 1999. *Equipment Management Program Price List*. Dayton, Ohio.
- Jowsey, P.C. 1966. "An Improved Peat Sampler." *New Phytologist*. Volume 65. Pages 245 through 248.
- Means. 1999. *Environmental Remediation Cost Data—Unit Price*. Kingston, Massachusetts.
- Tetra Tech. 1999a. Record of Telephone Conversation Regarding Sampler Costs. Between Kumar Topudurti, Environmental Engineer, and Jim Egbert, Purchasing Manager, AMS. August.

---

Tetra Tech. 1999b. "Sediment Sampling Technologies Data Evaluation Report." Prepared for ORD, EPA. October.

Wirtz Rentals Co. 1999. "Electric Hammers and Drills." On-Line Address: <http://www.wirtzrentals.com/hammers>. Accessed on August 4.

---

## Appendix A Developer's Claims for the AMS Split Core Sampler for Submerged Sediments

The product used in the SITE demonstration described in this report was a modified AMS Split Core Sampler for Submerged Sediments. The unmodified sampler has been used successfully to sample surface and subsurface soils for over 10 years at environmental sites throughout the United States and around the world. Prior to the SITE demonstration, AMS supplied about five Split Core Samplers modified to incorporate a ball check valve in the sampler top cap.

The Split Core Sampler incorporating a ball check valve in the sampler top cap allows air and water to escape from the sampler as it is lowered through the water column and pushed into submerged sediment. During sampler retrieval, the valve prevents backwash and subsequent loss of sample.

The modification to incorporate a catcher in the sampler tip has been found to assist in preventing loss of sample when dry-flowing soil is sampled. During the SITE demonstration, the catcher was too stiff to be effective for the submerged sediment that was sampled. AMS will continue its search for a catcher made from a softer plastic material.

The sampler's use of multiple body sections joined by couplings provides versatility in that the sampler can be deployed in lengths from 6 to about 48 inches for practical applications. Use of liners within the sampler allows the

collected sample to be capped in the field and subsampled or composited later in a sample handling area. This feature represents a significant advantage when multiple samples are being collected from a boat or platform with limited space.

The stainless-steel construction of the sampler and deployment accessories allows decontamination using all available methods. The ability to completely disassemble the sampler also supports an efficient decontamination process.

The rugged design of the sampler provides the durability needed for unknown field situations. There were no equipment failures during the demonstration.

Updates or improvements to the Split Core Sampler (Section A.1), prior deployment of the Split Core Sampler (Section A.2), and developer comments on the SITE demonstration (Section A.3) are presented below.

### **A.1 Updates or Improvements to the Split Core Sampler**

In S2A1, it was necessary on several occasions to disassemble the ball check valve in order to clear it of obstructions. The ball check valve is being modified to allow increased clearance around the ball. Consideration

Appendix A was written solely by AMS. The statements presented in this appendix represent the developer's point of view and summarize the claims made by the developer regarding the AMS Split Core Sampler for Submerged Sediments. Publication of this material does not represent the EPA's approval or endorsement of the statements made in this appendix; performance assessment and economic analysis results for the Split Core Sampler are discussed in the body of this ITVR.

is also being given to use of a larger ball with a larger vent hole.

## **A.2 Prior Deployment of the Split Core Sampler**

AMS made a modified Split Core Sampler with a ball check valve in the top cap for the Texas A&M Research Department at College Station about 3 years ago; the sampler was used successfully in wetland studies. Since then, at least four other companies have successfully used a vented sampler for wetland and underwater sampling.

## **A.3 Developer Comments on the SITE Demonstration**

First, AMS compliments the EPA SITE Program staff and Tetra Tech team on conducting an efficient demonstration. It was a real pleasure to work with them.

The problems experienced centered on determining exactly where the sediment surface was located in relation

to the water surface. For the Split Core Sampler, AMS determined that location to be where the sampling technician was just able to feel resistance. Upon reflection, this point may not have represented the true location of the sediment surface, particularly where the surface was made up of soft, gelatinous materials that may or may not be considered "sediment."

After several unsuccessful trial attempts to collect samples at the first sampling location in S2A1 using hand- or slide-hammer-assisted driving, a decision was made to use an electric impact hammer. This device was used to provide vibrations primarily to the sampler at all sampling locations where 110-volt power was available. Its use resulted in more efficient recovery of samples.

The Split Core Sampler had to be overpushed in order to recover the required sample volumes at many sampling locations. This need may have been avoided had a sampler with a larger inside diameter been available. Such a sampler would also have reduced the number of pushes needed to recover the required sample volumes.

Appendix A was written solely by AMS. The statements presented in this appendix represent the developer's point of view and summarize the claims made by the developer regarding the AMS Split Core Sampler for Submerged Sediments. Publication of this material does not represent the EPA's approval or endorsement of the statements made in this appendix; performance assessment and economic analysis results for the Split Core Sampler are discussed in the body of this ITVR.

---

## Appendix B

### Performance and Cost of the Ekman Grab

The EPA conducted a demonstration of an innovative sediment sampler known as the Split Core Sampler, a core sampler designed and fabricated by AMS of American Falls, Idaho. The demonstration was conducted under the EPA SITE Program at two sites during the last week of April and first week of May 1999. The purpose of this demonstration was to obtain reliable performance and cost data on the Split Core Sampler in order to (1) achieve a better understanding of the sampler's capabilities relative to conventional sediment samplers and (2) provide an opportunity for the sampler to enter the marketplace and compete with conventional samplers without long delays.

In addition to the Split Core Sampler and the reference samplers, a conventional grab sampler was included in the demonstration because grab samplers are commonly used to collect surficial sediment in order to assess the horizontal distribution of sediment characteristics. The Ekman Grab, a commonly used sampler, was chosen for the demonstration. Performance and cost data collected for the Ekman Grab are not intended to be compared to those for the Split Core Sampler but rather are presented in this appendix as supplemental information.

Specifically, this appendix describes the Ekman Grab that was demonstrated (Section B.1), two demonstration sites (Section B.2), demonstration approach (Section B.3), performance of the Ekman Grab (Section B.4), and references used to prepare this appendix (Section B.5).

#### **B.1 Description of the Ekman Grab**

The Ekman Grab is a "box" sampler whose bottom end collects sediment as the sampler penetrates the sediment. The sampler is designed to collect samples of soft, finely divided sediment that is free of vegetation, stones, and

other coarse debris. A technical description, general operating procedures, and advantages and limitations of the Ekman Grab are presented below.

##### ***B.1.1 Sampler Description***

Components of the Ekman Grab selected for the demonstration included (1) two stainless-steel scoops; (2) two stainless-steel springs attached to four scoop buttons; (3) two stainless-steel scoop cables; (4) a stainless-steel messenger; (5) a 3/16-inch-diameter, braided, polyester line or 5-foot-long, galvanized-steel extension handle; (6) a release mechanism consisting of a stainless-steel strike pad and two stainless-steel pins; and (7) two hinged, overlapping, stainless-steel lids (see Figure B-1).

Optional accessories include a 10-foot-long extension handle and weights that can be fastened to either side of the Ekman Grab. Top screens designed to prevent sediment from escaping from the top of the Ekman Grab are also available.

In water depths up to 10 feet, the Ekman Grab can be manually deployed using the extension handle. In water up to 60 feet deep and with low velocity, the sampler can be deployed using the polyester line and messenger. During sampler deployment, the two lids at the top of the sampler open to allow water to pass through the sampler in order to minimize bow wave formation, thus minimizing disturbance of the sediment. Once the sampler is deployed to the desired sampling location, the release mechanism is actuated using the extension handle or the messenger on the polyester line. Once actuated, the mechanism releases the scoop cables, allowing the springs to close the scoops and collect a sediment sample. During

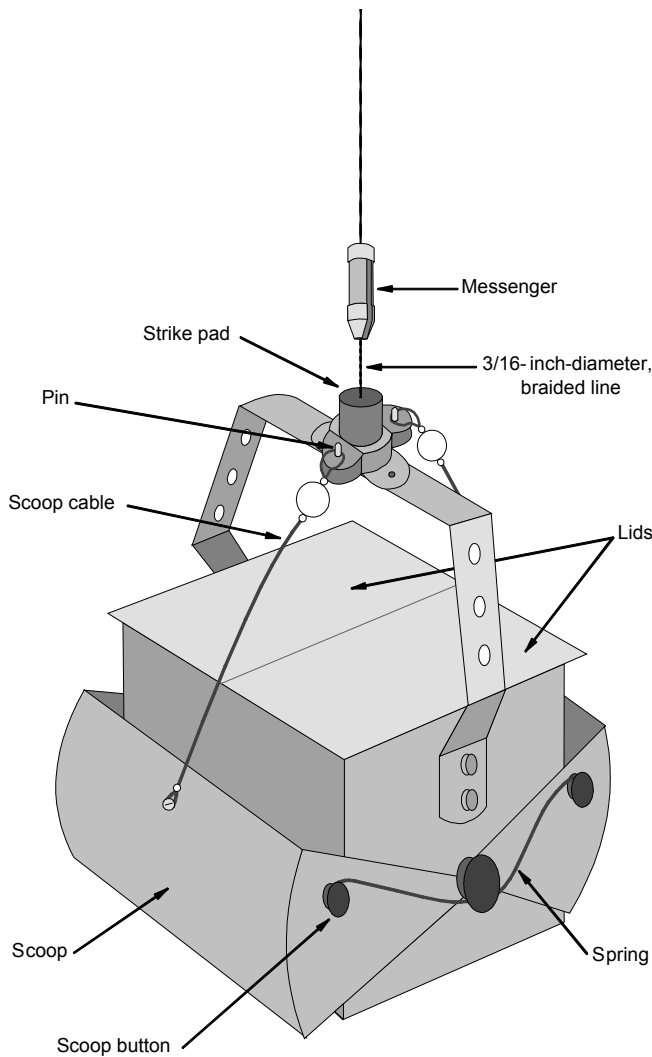

**Figure B-1. Ekman Grab.**

sampler retrieval, the lids automatically close to minimize sample washout.

The Ekman Grab is available in many sizes; however, for this demonstration, the standard-size Ekman Grab was chosen because of its ability to collect a sample volume that met the demonstration objectives while generating relatively little IDW. The standard-size Ekman Grab contains a 6-inch-long, 6-inch-wide, and 6-inch-high sample chamber with a volume of 3,460 mL. The area below the chamber created by the two scoops when closed constitutes an additional 630 mL. The fully assembled Ekman Grab, not including the extension handle, weighs about 10 lb.

### ***B.1.2 General Operating Procedures***

The Ekman Grab can be manually operated by one person from a sampling platform or while wading in shallow water. Prior to sampler deployment, each of the two springs must be manually attached to the two scoop buttons on either side of the sampler. Also, before the Ekman Grab is lowered into the water, each scoop cable must be manually hooked to one of the two pins in order to hold the sampler in an open position. During and after sampler preparation for deployment, care must be used to avoid catching any body parts such as fingers or feet between the scoops.

The sampler can be manually lowered to the sediment surface using the extension handle or polyester line. In either case, the speed of sampler deployment needs to be controlled in order to avoid bow wave formation. If the polyester line is used, the sampler should not be allowed to fall freely for a significant distance. The sampler should be manually lowered to the sediment surface and then slightly raised before it is released; this procedure allows the weight of the sampler to control sediment penetration.

Once the sampler penetrates the sediment, the release mechanism is actuated using the extension handle or by placing the messenger on the polyester line and allowing it to slide down the line to the strike pad. When the strike pad is depressed, the pins are lowered, the scoop cables are released, and the springs close the scoops to collect a sediment sample. After the scoops are fully closed, the Ekman Grab should be raised slowly from the sediment and then raised steadily to the water surface.

There are several ways to process grab samples collected using the Ekman Grab. Upon removal of the sampler from the water, the grab sample may be discharged into a bucket or bowl. Another way of processing the sample is to keep the scoops closed and open the lids on top of the sampler; then small-diameter tubes can be inserted into the top portion of the sampler to collect subsamples.

### ***B.1.3 Advantages and Limitations***

An advantage of the Ekman Grab is that it is easy to operate, requiring minimal skills and training. Sampler assembly and collection procedures can be learned in the



field with a few practice attempts. In addition, a written SOP typically accompanies the sampler when it is procured. The sampler can be operated by one person in shallow (wading) and deep water depths because of its lightness (10 lb, not including the weight of the extension handle). Sampler operation is simple because the sampler does not require complete disassembly and reassembly after each sampling attempt. Only the scoops have to be opened in order to retrieve the sediment sample. The sampler also requires no support equipment.

Another advantage of the Ekman Grab is that during sampler deployment, the two lids at the top of the sampler open to allow water to pass through the sampler and to minimize the bow wave formation, thus minimizing disturbance of the sediment. The sampler's scoops are designed to overlap in the closed position in order to minimize sample loss during sampler retrieval. In addition, the release mechanism and pivoting scoops are designed to minimize sediment disturbance when a sample is collected.

A limitation of the Ekman Grab is that because of its lightness, the sampler may not be able to penetrate consolidated sediment if the sampler is deployed by gravity penetration with a polyester line. In addition, small stones or vegetation may become caught between the scoops, causing the scoops to remain in the open position during sampler retrieval, resulting in partial or complete loss of the sample. Also, during and after sampler preparation for deployment, care must be used to avoid catching any body parts such as fingers or feet between the scoops.

## B.2 Description of the Demonstration Sites

The Ekman Grab was demonstrated at two sites in EPA Regions 1 and 5. At the Region 1 site, Ekman Grab sampling was conducted in one sampling area (S2A1) that represented lake conditions and had a water depth of about 18 feet. At the Region 5 site, Ekman Grab sampling was conducted in two areas. One area (S1A1) was in a river mouth and had a water depth of about 5 to 6 feet. The other area (S1A2) was in a freshwater bay along a river and had a water depth of about 2 feet.

Additional information on demonstration site and area characteristics and the sampling platforms used is provided in Chapter 3 of the ITVR.

## B.3 Demonstration Approach

This section presents the demonstration objectives, design, and field sampling and measurement procedures, for the Ekman Grab.

### B.3.1 Demonstration Objectives

The demonstration had both primary and secondary objectives. Primary objectives were critical to the technology evaluation and were intended to produce quantitative results regarding technology performance. Secondary objectives provided information that was useful but did not necessarily produce quantitative results regarding technology performance.

As stated in Section 4.1 of the ITVR, the primary objectives for the demonstration were as follows:

- P1. Evaluate whether the sampler can consistently collect a specified volume of sediment
- P2. Determine whether the sampler can consistently collect samples in a specified depth interval
- P3. Assess the sampler's ability to collect multiple samples with consistent physical or chemical characteristics, or both, from a homogenous layer of sediment
- P4. Evaluate whether the sampler can collect a representative sample from a "clean" sediment layer that is below a contaminated sediment layer
- P5. Assess the sampler's ability to be adequately decontaminated between sampling areas
- P6. Measure the time required for each activity associated with sample collection (sampler setup, sample collection, sampler disassembly, and sampler decontamination)
- P7. Estimate costs associated with sample collection activities (sampler, labor, IDW disposal, and support equipment costs)

Primary objective P4 was not addressed for the Ekman Grab because this sampler is not designed in such a way

that it can be evaluated under P4. The secondary objectives for the demonstration were as follows:

- S1. Document the skills and training required to properly operate the sampler
- S2. Evaluate the sampler’s ability to collect samples under a variety of site conditions
- S3. Assess the sampler’s ability to collect an undisturbed sample
- S4. Evaluate the sampler’s durability based on its materials of construction and engineering design
- S5. Document the availability of the sampler and spare parts

**B.3.2 Demonstration Design**

Samples were collected using the Ekman Grab to obtain supplemental performance and cost data. Table B-1 summarizes the demonstration design for collecting grab samples. Sediment samples were collected using the Ekman Grab only in the 0- to 4-inch bss depth intervals in

S1A1, S1A2, and S2A1. The Ekman Grab is designed to collect surficial sediment samples in areas that are largely free of vegetation. According to the findings of the predemonstration investigation, most of the surficial material in S2A2 was composed of decomposed leaves and wood chips. Therefore, grab samples were not collected in S2A2. The approach for addressing the primary objectives using the Ekman Grab was generally the same as that for the Split Core Sampler presented in Section 4.2 of the ITVR. Differences in the approach for the Ekman Grab are discussed below.

- Primary objective P1 was generally addressed as described for the Split Core Sampler. The volume of sediment collected was noted. However, measurement of core lengths was not appropriate for the Ekman Grab and was not conducted.
- Primary objective P2 was generally addressed as described for the Split Core Sampler. The volume of sediment collected and the approximate sampler penetration depth were noted. However, measurement of core lengths was not appropriate for the Ekman Grab and was not conducted.

**Table B-1. Ekman Grab Demonstration Design**

Demonstration Area	Target Sampling Depth Interval (inches bss)	Primary Objective	Sampling Parameter (Matrix)	Volume Required per Sample
S1A1 (river mouth)	0 to 4	P1 Volume P2 Depth interval P3 Consistent samples from a homogenous layer P6 Sample collection time	PSD and volume (sediment)	250 mL
S1A2 (freshwater bay)	0 to 4	P1 Volume P2 Depth interval P5 Decontamination P6 Sample collection time P7 Cost	PCBs and volume (sediment) PCBs (final rinsate)	250 mL 1 L
S2A1 (lake)	0 to 4	P1 Volume P2 Depth interval P3 Consistent samples from a homogenous layer P5 Decontamination P6 Sample collection time P7 Cost	Arsenic, PSD, and volume (sediment) Arsenic (final rinsate)	250 mL 500 mL

Notes:

- bss = Below sediment surface
- L = Liter
- mL = Milliliter
- PCB = Polychlorinated biphenyl
- PSD = Particle size distribution

- Primary objective P3 was addressed as described for the Split Core Sampler except that sample collection was limited to the 0- to 4-inch bss depth intervals in S1A1 and S2A1.
- Primary objectives P5, P6, and P7 were addressed in the 0- to 4-inch bss depth intervals in S1A2 and S2A1 as described for the Split Core Sampler. P6 was also addressed in the 0- to 4-inch bss depth interval in S1A1.

Secondary objectives S1, S2, and S3 were addressed for the Ekman Grab in all three demonstration areas because no additional sampling was required to address them. Secondary objectives S4 and S5 were not area-dependent; they were addressed for the Ekman Grab based on information provided by the sampling technician as well as observations of sampler performance during the demonstration. The approach for addressing each secondary objective was the same as that for the Split Core Sampler presented in Section 4.2 of the ITVR.

### ***B.3.3 Field Sampling and Measurement Procedures***

Using the Ekman Grab, sediment samples were collected in S1A1 for PSD analysis, in S1A2 for PCB analysis, and in S2A1 for PSD and arsenic analyses. The sampling locations in each of these demonstration areas are presented in Figure B-2. Additional information on these areas and the sampling platforms used is presented in Chapter 3 of the ITVR. Table B-2 lists the target sampling depth interval, planned numbers of investigative samples, and analytical parameters for each demonstration area and provides the rationale for their selection. In general, the rationale for choosing the number of samples to be collected in each area was based on the objectives to be addressed, the analyses to be conducted to address one or more objectives, the time required to collect samples, and the cost of each analysis. When five samples were to be collected in a sampling area, samples were collected in the four corners and center of the area; when ten samples were to be collected in a sampling area, the additional five samples were collected at locations randomly distributed throughout the area.

Many of the field measurements made to support the primary objectives were simple, standard measurements

and do not require additional explanation. These measurements included the volume of IDW generated, number of sampling technicians, number of sampling attempts per location, volume of sediment collected, time required for sample collection activities, sampling area grid size, and water velocity. However, several field measurements were made to address demonstration-specific requirements, and additional explanation of these measurements is warranted to enhance understanding of the sampler performance results presented in Section B.4. Information regarding sample preparation, sampler decontamination, and measurement of the time required to conduct sample collection activities (sampler setup, sample collection, sampler disassembly, and sampler decontamination) is presented in Section 4.3 of the ITVR.

The depth of Ekman Grab deployment was measured after the sampling technician had lowered the sampler to the sediment surface. Once the technician identified the location of the sediment surface using the sampler, a mark was made on the extension handle or polyester line with reference to a fixed point (the boat side or floor). For extension handle applications, another mark was made higher on the extension handle indicating the depth to which the sampler should be pushed in order to collect a sediment sample in the target sampling depth interval. The sampler was pushed to this depth, and a sample was collected. For polyester line applications, the depth of sampler deployment was dictated by gravity penetration. Once the sampling technician had lowered the sampler to the sediment surface using the polyester line, he allowed the sampler to penetrate the sediment by its own weight. The depth of sampler deployment was then measured by making another mark on the polyester line with reference to the fixed point.

Field and laboratory QC checks for the demonstration are discussed in Sections 4.3 and 4.4 of the ITVR, respectively. Section 4.4 of the ITVR also presents the laboratory sample preparation and analysis methods. Table B-3 identifies the planned numbers of sediment and equipment rinsate samples. Acceptance criteria and associated corrective actions for field QC checks are presented in the demonstration plan (EPA 1999). A summary discussion of whether the field and laboratory QC procedures generated scientifically valid and legally defensible data that met the demonstration objectives is presented in Section B.4.3.

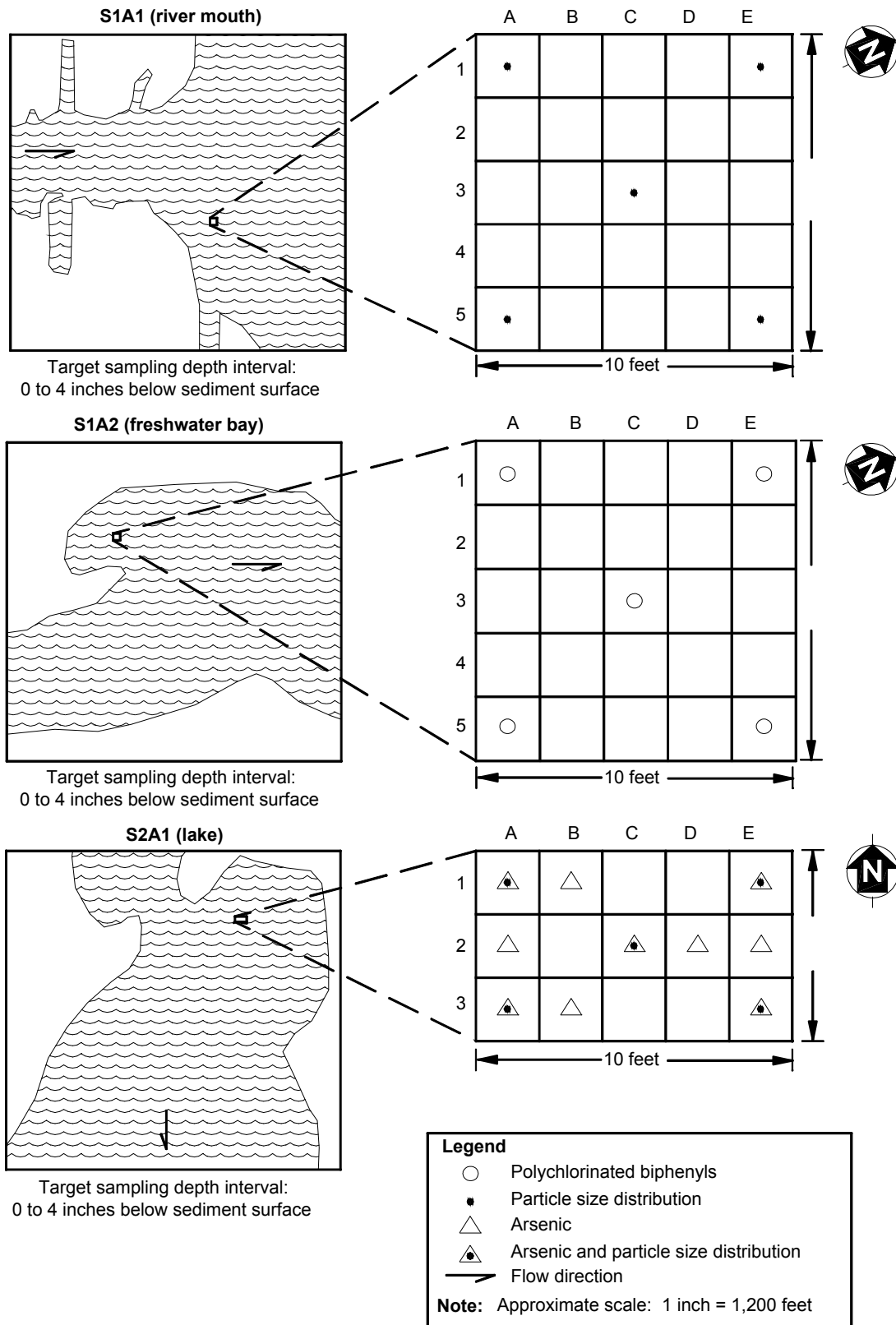

Figure B-2. Sampling locations for Ekman Grab demonstration.

**Table B-2. Rationale for Sampling Approach**

Demonstration Area	Target Sampling Depth Interval (inches bss)	Number of Investigative Samples <sup>a</sup> (Analytical Parameter)	Matrix	Rationale
S1A1 (river mouth)	0 to 4	5 (PSD)	Sediment	Determine whether an Ekman Grab could collect multiple samples from a homogenous layer of sediment (primary objective P3) with consistent characteristics
S1A2 (freshwater bay)	0 to 4	5 (PCBs)	Sediment	Determine whether an Ekman Grab could be adequately decontaminated (primary objective P5)
		1 (PCBs)	Equipment rinsate	Determine whether an Ekman Grab could be adequately decontaminated (primary objective P5)
S2A1 (lake)	0 to 4	10 (Arsenic) 5 (PSD)	Sediment	Determine whether an Ekman Grab could collect multiple samples from a homogenous layer of sediment (primary objective P3) with consistent characteristics
		1 (Arsenic)	Equipment rinsate	Determine whether an Ekman Grab could be adequately decontaminated (primary objective P5)

Notes:

- bss = Below sediment surface
- PCB = Polychlorinated biphenyl
- PSD = Particle size distribution

<sup>a</sup> The number of investigative samples varied depending on the analytical parameters and the objectives addressed in each demonstration area. Ten investigative samples were collected and analyzed for arsenic to address primary objective P3. However, only five investigative samples were collected and analyzed for PSD to address primary objective P3 because the variability associated with PSD is less than that associated with arsenic concentrations.

**B.4 Performance of the Ekman Grab**

This section describes the performance of the Ekman Grab based on the primary objectives (Section B.4.1) and secondary objectives (Section B.4.2); this section also discusses the data quality of the demonstration results for the Ekman Grab (Section B.4.3).

**B.4.1 Primary Objectives**

This section discusses the performance results for the Ekman Grab based on the primary objectives specified in Section B.3.1. To address these primary objectives, samples were collected in three different areas: (1) S1A1, a river mouth; (2) S1A2, a small, freshwater bay; and (3) S2A1, a lake. Samples were collected only in the 0- to 4-inch bss depth interval in these areas because the Ekman Grab is capable of collecting surficial sediment only. The numbers of investigative and QC samples collected in each area, sediment sample volumes required, and sample analytical parameters are presented in Table B-3.

During the demonstration, because the water depth in S1A1 and S2A1 exceeded the length of the extension handle (5 feet), the sampling technician deployed the Ekman Grab by gravity penetration using a polyester line. In S1A2, where the water depth was about 2 feet, the sampler was deployed with the 5-foot-long extension handle. The sampling technician was provided an opportunity to practice sample collection at each demonstration area until he felt confident enough to initiate demonstration sampling.

The demonstration results for the Ekman Grab under primary objectives P1 and P2 were evaluated using the Wilk-Shapiro test to determine whether the results were normally distributed. Because most of the data sets were not normally distributed, the Wilk-Shapiro test was used in an attempt to evaluate whether the results followed a lognormal distribution. The test revealed that the results either were not lognormally distributed or could not be tested for lognormality because the results contained values equal to zero. For these reasons, the Student's t-test, a parametric test, was not used to perform the hypothesis testing; the Wilcoxon signed rank test, a nonparametric test, was used as an alternative to the

**Table B-3. Ekman Grab Sample Matrix**

Demonstration Area	Target Sampling Depth Interval (inches bss)	Analytical Parameter	Sediment Samples				Equipment Rinsate Samples		
			Investigative Samples	MS/MSD Samples <sup>a</sup>	Field Triplicate Samples <sup>b</sup>	Laboratory Analyses	Equipment Rinsate Samples	Field Duplicate Samples <sup>c</sup>	Laboratory Analyses
S1A1 (river mouth)	0 to 4	PSD	5	NA	1	7	NA	NA	0
S1A2 (freshwater bay)	0 to 4	PCBs	5	1	2	11	1	1	2
S2A1 (lake)	0 to 4	Arsenic PSD	10 5	2 NA	3 1	20 7	1 NA	1 NA	2 0

**Notes:**

- bss = Below sediment surface
- MS/MSD = Matrix spike/matrix spike duplicate
- NA = Not applicable
- PCB = Polychlorinated biphenyl
- PSD = Particle size distribution

<sup>a</sup> MS/MSD samples were collected for PCB and arsenic analyses and were designated in the field. MS/MSD samples were not collected for equipment rinsate samples because the additional volume required for the analysis may have diluted any contamination present to concentrations below laboratory detection limits. Sediment MS/MSD samples did not require additional sample volume.

<sup>b</sup> Field triplicate sediment samples were collected by filling three sample containers with homogenized sediment. A sufficient volume of sediment for field triplicate samples was collected as described in the approach for addressing primary objective P1 in Section 4.2 of the innovative technology verification report. Field triplicate samples were submitted for analysis as blind samples.

<sup>c</sup> Field duplicate equipment rinsate samples were collected by filling one additional container for PCB or arsenic analysis. Field duplicate samples were submitted for analysis as blind samples.

Student’s t-test. As described in Section 6.1 of the ITVR, Statistix<sup>®</sup> was used to perform statistical evaluations of the demonstration results (Analytical Software 1996). Appendix C provides details on the statistical methods used for data evaluation.

**B.4.1.1 Ability to Consistently Collect a Specified Volume of Sediment**

Primary objective P1 involved evaluating the Ekman Grab’s ability to consistently collect a specified volume of sediment. This objective was addressed by comparing (1) the actual number of sampling attempts required to collect a specified volume of sediment to the expected number of attempts (rounded to the nearest higher integer) at each sampling location and (2) the actual volume of sediment collected in each attempt to the calculated sampler volume (design volume). The expected number of attempts was determined by dividing the specified sample volume by the design volume. The results of these comparisons are summarized below.

**Number of Sampling Attempts Required**

Tables B-4 and B-5 present the expected and actual number of sampling attempts for the Ekman Grab in S1A1 and S1A2 and in S2A1, respectively. Initially, the Wilcoxon signed rank test was used to determine whether the difference between the expected and actual number of attempts was statistically significant. However, in two of the three areas, there were too few locations where the expected number of attempts differed from the actual number to perform the test.

Regarding the number of sampling attempts required to collect the specified volume, the Ekman Grab performed well in all three areas. As shown in Tables B-4 and B-5, the actual number of attempts equaled the expected number of attempts at 15 of 20 locations. In S1A1, Location 1A was the only location where the actual number of attempts (four) exceeded the expected number (one) by more than one attempt. In two of the four

**Table B-4. Comparison of Expected and Actual Number of Sampling Attempts for Ekman Grab at Site 1**

Location	Number of Attempts in S1A1 (River Mouth)		Number of Attempts in S1A2 (Freshwater Bay)	
	Expected	Actual	Expected	Actual
1A	1	4	1	1
1E	1	1	1	1
3C	1	1	1	1
5A	1	1	1	1
5E	1	2	1	1
Total	5	9	5	5

**Table B-5. Comparison of Expected and Actual Number of Sampling Attempts for Ekman Grab in S2A1 (Lake)**

Location	Number of Attempts in S2A1	
	Expected	Actual
1A	1	1
1B	1	2
1E	1	2
2A	1	1
2C	1	1
2D	1	1
2E	1	2
3A	1	1
3B	1	1
3E	1	1
Total	10	13

attempts at Location 1A, only one scoop was closed after the messenger was released, and the sediment sample was lost through the open scoop.

Much of the sampler’s overall success in terms of number of sampling attempts required can be attributed to the design volume for the Ekman Grab (about 2,900 mL for the 0- to 4-inch bss depth interval, including the volume of the scoops) being much greater than the specified sediment sample volumes, which ranged from 250 to 1,000 mL. Consequently, a sampling attempt with low recovery compared to the design volume could still collect the specified volume of sediment.

**Volume of Sediment Collected**

The volume of sediment collected by the Ekman Grab in each sampling attempt was divided by the corresponding design volume, and the resulting ratio was multiplied by

100 to estimate the PSR. The RSD of the PSRs was calculated to evaluate the ability of the Ekman Grab to consistently collect a specified volume of sediment; if the sampler were to consistently recover an identical volume of sediment in every attempt, the RSD would equal zero. Both PSR and RSD results should be considered to properly evaluate the sampler’s performance because a low RSD, which indicates that the sampler’s performance was consistent, may be based on consistently low PSRs. Table B-6 presents the PSR summary statistics (range, mean, and RSD) for all three areas. Figure B-3 presents PSRs for the Ekman Grab in S1A1, S1A2, and S2A1.

The Ekman Grab performed well in S1A2 but had difficulty in S1A1 and S2A1. As shown in Table B-6, for S1A2, PSRs ranged from 100 to 145 with a mean PSR of 127. The RSD of the PSRs for S1A2 (13 percent) compares favorably to the 30 percent RSD guideline discussed in Section 6.1.1 of the ITVR. On the other hand, as shown in Figure B-3, 5 of 9 attempts in S1A1 and 3 of 13 attempts in S2A1 had PSRs in the 0 to 20 range. These low recoveries were due to the failure of one or both scoops to close after the messenger was released or to incomplete sampler penetration of the specified depth interval. Unlike S1A2, where the sampler was deployed with an extension handle, the sampler was deployed by gravity penetration using a polyester line in S1A1 and S2A1. As a result, the sampling technician had relatively poor control of the depth of sampler penetration. As shown in Table B-6, RSDs of 103 and 65 percent that exceeded the 30 percent RSD guideline were observed for S1A1 and S2A1, respectively, indicating that the Ekman Grab did not consistently collect its design volume.

In summary, the Ekman Grab performed well with regard to the number of attempts required, but did not perform well with regard to consistently collecting its design

**Table B-6. Percent Sample Recovery Summary Statistics for Ekman Grab**

Demonstration Area	Actual Number of Attempts	PSR Range <sup>a</sup>	Mean PSR	RSD (%)
S1A1 (river mouth)	9	0 to 40	16	103
S1A2 (freshwater bay)	5	100 to 145	127	13
S2A1 (lake)	13	0 to 71	38	65

Notes:

PSR = Percent sample recovery  
 RSD = Relative standard deviation

<sup>a</sup> PSRs exceeding 100 resulted from pushing the sampler beyond the specified depth interval because of difficulty in accurately assessing the location of the sediment, the volumetric measurement error associated with the presence of void spaces when the sediment was transferred to a graduated container, or both.

volume. The actual number of attempts equaled the expected number of attempts at 15 of 20 locations. However, for S1A1 and S2A1, low mean PSRs (16 and 38, respectively) and high RSDs (103 and 65 percent, respectively) were observed, indicating low and inconsistent recoveries. For S1A2, a much lower RSD (13 percent) was observed. In addition, all the PSRs for sampling attempts in S1A2 were 100 or greater.

**B.4.1.2 Ability to Consistently Collect Sediment in a Specified Depth Interval**

Primary objective P2 involved evaluating the Ekman Grab’s ability to consistently collect sediment in a specified depth interval by comparing actual and target core lengths for each attempt. The Ekman Grab does not collect a core, but to facilitate its comparison to the other samplers, the actual depth interval sampled in a given attempt was calculated based on the Ekman Grab’s design volume and the volume of sediment collected.

The Ekman Grab’s box chamber is 6 inches tall and can hold about 580 mL of sediment per inch. The scoop chamber has a triangular cross section; is approximately 1.5 inches tall in the middle; and can hold about 105 mL in the bottom one-third, about 210 mL in the middle one-third, and about 315 mL in the top one-third, which amounts to a total volume of about 630 mL. Therefore, if the Ekman Grab collected 2,100 mL of sediment in a given attempt, the sampling depth interval is 0 to 4 inches bss because the 1.5-inch-tall scoop chamber holds 630 mL, and the remaining 1,470 mL would fill approximately 2.5 inches of the box chamber at 580 mL per inch. However, the height of the scoop chamber was not accounted for during demonstration sampling, and the sampling technician tried to push the box chamber to a depth of 4 inches bss in each attempt. Consequently, the

target sediment thickness in each area was actually 5.5 inches instead of 4 inches, which corresponds to a sample volume of approximately 2,900 mL.

Table B-7 presents the number of attempts in which the actual sediment thickness equaled the target sediment thickness, target sediment thicknesses, and mean actual sediment thicknesses. Initially, the Wilcoxon signed rank test was to be used to determine whether differences between the actual and target sediment thicknesses were statistically significant. However, the Wilcoxon signed rank test revealed that the test results for many of the primary objective P2 data sets were inconsistent with the conclusions reached in comparing the actual and target sediment thicknesses for the reasons described in Section 6.1 of the ITVR. Therefore, P2 was addressed by evaluating (1) the number of attempts in which the actual sediment thickness equaled the target sediment thickness and (2) the difference between the target sediment thickness and the mean actual sediment thickness.

The Ekman Grab did not perform well in any of the three areas. As shown in Table B-7, sediment thicknesses collected by the Ekman Grab equaled the target sediment thicknesses in only 1 of 27 attempts. Attempts in S1A1 and S2A1 generally had low recoveries (0 to 40 percent in S1A1 and 0 to 71 percent in S2A1), which resulted in low mean actual sediment thicknesses of 1.0 and 2.5 inches, respectively. In S1A2, the mean actual sediment thickness of 6.5 inches exceeded the target sediment thickness of 5.5 inches. Although the Ekman Grab sampled the entire target sediment thickness in all 5 attempts, in 4 of the 5 attempts in S1A2, the actual sediment thickness



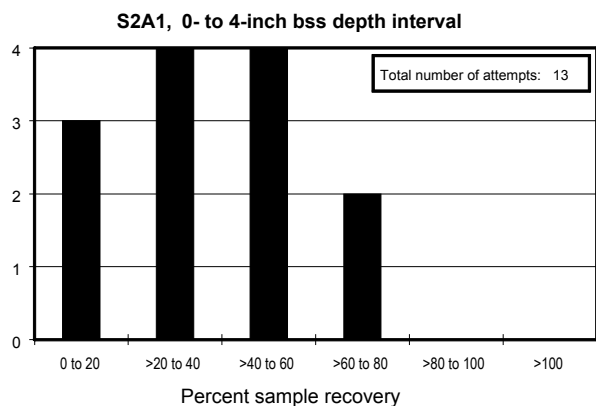
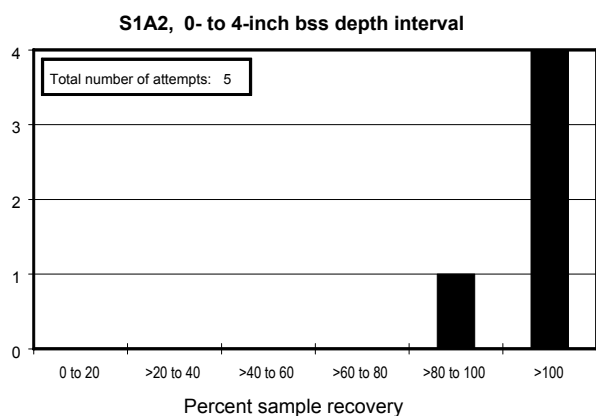
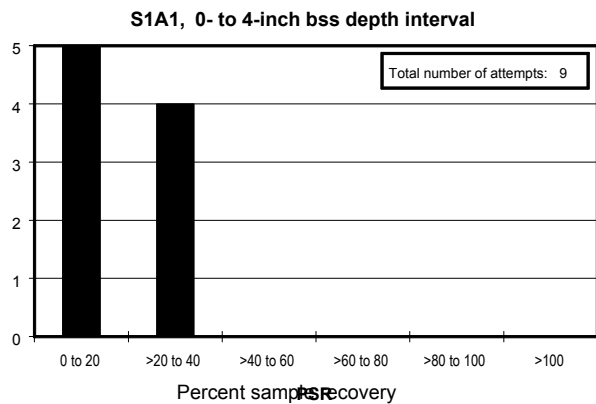

Notes:

bss = Below sediment surface

Percent sample recoveries exceeding 100 resulted from pushing the sampler beyond the specified depth interval because of difficulty in accurately assessing the location of the sediment surface, the volumetric measurement error associated with the presence of void spaces when the sediment was transferred to a graduated container, or both.

**Figure B-3. Percent sample recoveries for Ekman Grab in S1A1 (river mouth), S1A2 (freshwater bay), and S2A1 (lake).**

exceeded the target sediment thickness by 1 inch on average. Because of the nature of the sampler, the portion of the sediment sample corresponding to the 5.5- to 6.5-inch bss depth interval could not be separated from that corresponding to the target depth interval. Based on demonstration results, the Ekman Grab did not demonstrate an ability to consistently collect sediment in the specified depth interval.

#### B.4.1.3 Ability to Collect Multiple Samples with Consistent Physical or Chemical Characteristics, or Both, from a Homogenous Layer of Sediment

Primary objective P3 involved evaluating the Ekman Grab's ability to collect multiple samples with consistent physical or chemical characteristics, or both, from a homogenous layer of sediment. This objective was addressed by calculating the RSD values for the S1A1 and S2A1 sample analytical results. Based on the predemonstration investigation results, the 0- to 4-inch bss depth intervals in these areas were determined to be homogenous in terms of their physical characteristics, and the S2A1 depth interval was determined to be homogenous in terms of its chemical characteristics.

Figure B-4 presents the Ekman Grab sample analytical results for S1A1 and S2A1. Although no outliers were found in the arsenic and PSD results for the samples collected by the Ekman Grab, the sampler was evaluated only on its ability to collect multiple samples with consistent physical characteristics; this approach was used to be consistent with the evaluations of the innovative and reference samplers discussed in Sections 6.1.3 and 7.1.3, respectively. Also, the Ekman Grab sample arsenic concentrations for S2A1 varied over a wide range (53 to 240 mg/kg), indicating that the area may not be chemically homogenous despite the lack of statistical outliers. The RSDs were calculated based on the PSD analytical results for all locations sampled in S1A1 and S2A1.

Table B-8 presents PSD summary statistics (range, mean, and RSD) calculated for the Ekman Grab samples and field triplicates relevant to primary objective P3. As stated in Section 6.1.3 of the ITVR, RSDs calculated for the PSD results were compared to the laboratory acceptance criterion of 15 percent for field triplicates. When the RSD for all samples was greater than 15 percent, it was compared to the measured RSD for the

**Table B-7. Comparison of Target and Actual Sediment Thickness Data for Ekman Grab**

Demonstration Area	Number of Attempts in Which Actual Sediment Thickness Equaled Target Sediment Thickness/Total Attempts	Target Sediment Thickness (inches)	Mean Actual Sediment Thickness (inches)
S1A1 (river mouth)	0/9	5.5	1.0
S1A2 (freshwater bay)	1/5	5.5	6.5
S2A1 (lake)	0/13	5.5	2.5

field triplicates, which were prepared by first homogenizing and then subsampling the sediment collected in a given location and area. An RSD for all samples that is less than the RSD for field triplicates may be more attributable to the laboratory’s analytical procedure or the sample homogenization procedure implemented in the field, or both, for the sediment sampled than to the sampler’s ability to collect physically consistent samples. However, PSD parameters with means less than 10 percent were not evaluated in this manner because at low levels, the analytical method is not as precise; as a result, it will generate high RSD values and may not reveal whether multiple samples with consistent physical characteristics have been collected.

As shown in Table B-8, the RSDs for silt results for both S1A1 and S2A1 were below the 15 percent laboratory acceptance criterion. The RSD for the sand result for S1A1 was also below the laboratory acceptance criterion, but the sand result RSD for S2A1 (17 percent) was slightly above the laboratory acceptance criterion and above the measured RSD for field triplicates (8 percent). Therefore, some of the variation in the sand results may be attributable to the Ekman Grab’s ability to collect samples with consistent physical characteristics. However, the variation in the sand results for S2A1 was not considered to be significant because it was only 2 percentage points greater than the laboratory acceptance criterion. The mean clay results for samples collected in both S1A1 and S2A1 were less than 10 percent and were not evaluated using the criterion. However, the clay results fell in a tight range (0 to 2 and 0 to 5 percent in S1A1 and S2A1, respectively).

In summary, the Ekman Grab met primary objective P3 criteria except for a 2 percentage point exceedance in the RSD for sand results for S2A1. Therefore, it was concluded that the Ekman Grab was able to collect multiple samples with consistent physical characteristics.

**B.4.1.4 Ability to be Adequately Decontaminated**

Primary objective P5 involved evaluating the Ekman Grab’s ability to be adequately decontaminated. This objective was addressed by collecting equipment rinsate samples after sampler decontamination activities in S1A2 and S2A1. These areas were chosen because they contained high concentrations of PCBs and arsenic, respectively. If the Ekman Grab were adequately decontaminated, the analytical results for the equipment rinsate samples would be below the laboratory’s reporting limits. To ensure that the water used to decontaminate the sampler was not contaminated, decontamination water blanks were also analyzed. Contaminant concentrations in both the equipment rinsate samples and decontamination water blanks were below the laboratory reporting limits for PCBs (1 part per billion) and arsenic (10 parts per billion). Thus, the Ekman Grab demonstrated the ability to be adequately decontaminated.

**B.4.1.5 Time Requirements for Sample Collection Activities**

Primary objective P6 involved evaluating the Ekman Grab’s time requirements for sample collection activities. These requirements were evaluated in S1A1, S1A2, and S2A1. One technician conducted sampler setup, sample collection, sampler disassembly, and sampler decontamination in each of the three demonstration areas. The amounts of time required to complete these activities are shown in Table B-9. The time measured for sample collection activities did not include the time taken for mobilization, demobilization, and maneuvering the sampling platforms to sampling locations because these activities were not sampler-specific; they were either site- or weather-related.

**S1A1**

<b>Location 1A</b> Sand: 83% Silt: 17% Clay: 0%				<b>Location 1E</b> Sand: 84% Silt: 14% Clay: 2%
		<b>Location 3C</b> Sand: 84% Silt: 15% Clay: 0%		
<b>Location 5A</b> Sand: 85% Silt: 15% Clay: 0%				<b>Location 5E</b> Sand: 86% Silt: 13% Clay: 1%

**S2A1**

<b>Location 1A</b> Arsenic: 110 mg/kg Sand: 39% Silt: 55% Clay: 5%	<b>Location 1B</b> Arsenic: 87 mg/kg			<b>Location 1E</b> Arsenic: 200 mg/kg Sand: 33% Silt: 57% Clay: 2%
<b>Location 2A</b> Arsenic: 240 mg/kg		<b>Location 2C</b> Arsenic: 110 mg/kg Sand: 42% Silt: 53% Clay: 4%	<b>Location 2D</b> Arsenic: 160 mg/kg	<b>Location 2E</b> Arsenic: 130 mg/kg
<b>Location 3A</b> Arsenic: 53 mg/kg Sand: 52% Silt: 46% Clay: 0%	<b>Location 3B</b> Arsenic: 110 mg/kg			<b>Location 3E</b> Arsenic: 89 mg/kg Sand: 48% Silt: 51% Clay: 0%

Notes:

mg/kg = Milligram per kilogram

The particle size distribution results for a given sample may not total 100 percent because of rounding or because some sediment did not pass through a U.S. Standard No. 4 sieve and was classified as gravel rather than sand, silt, or clay.

Figure B-4. Ekman Grab sample analytical results for S1A1 (river mouth) and S2A1 (lake).

**Table B-8. Particle Size Distribution Summary Statistics for Ekman Grab**

Demonstration Area	Parameter	Number of Samples	Range (%)	Mean (%)	RSD (%) (All Samples)	RSD (%) (Field Triplicates)
S1A1 (river mouth)	Sand	5	83 to 86	84	1	1
	Silt	5	13 to 17	15	10	8
	Clay	5	0 to 2	1	128	173
S2A1 (lake)	Sand	5	33 to 52	43	17	8
	Silt	5	46 to 57	53	8	4
	Clay	5	0 to 5	2	104	35

Note:

RSD = Relative standard deviation

Sampler setup times for the Ekman Grab ranged from 1 minute in S1A1 and S2A1 to 4 minutes in S1A2. The Ekman Grab was operated using a polyester line in S1A1 and S2A1 because the water depth was greater than the length of the extension handle available during the demonstration. In S2A1, the sampler arrived with the polyester line used to lower the sampler already attached; therefore, the setup time for S2A1 was estimated to be equal to the setup time for S1A1. An extension handle was used instead of the polyester line in S1A2, which required additional sampler setup time.

Sample collection times for the Ekman Grab ranged from 8 to 40 minutes during the demonstration. Sample collection required 0.5 to 2 minutes per attempt in S1A1 and S1A2 but 1.5 to 3.5 minutes per attempt in S2A1. Additional time was required in S2A1 because it was the first area sampled and because the water depth was 18 feet.

Sampler disassembly times for the Ekman Grab ranged from 1 to 3 minutes during the demonstration. Sampler disassembly required 3 minutes in S1A2. In S1A1, the disassembly time was estimated to be equal to the sampler setup time. Because a disassembly time of less than 1 minute was recorded in S2A1, the time for sampler disassembly in this area was conservatively rounded up to 1 minute.

Decontamination of the Ekman Grab required 22 minutes in S1A2 and 13 minutes in S2A1; sampler decontamination time was not evaluated in S1A1. Decontamination of the extension handle used in S1A2 accounts for the difference in decontamination times between this area and S2A1.

A technician familiar with the Ekman Grab would be expected to require 1 to 4 minutes for sampler setup, 0.5 to 2 minutes per attempt for sample collection, about 3 minutes for sampler disassembly, and 15 to 20 minutes for sampler decontamination. However, these activities might take longer, depending on the number of extension handles used at a given location. Furthermore, when sediment sampling activities are planned, the time required for mobilization, demobilization, and setting up and positioning the sampling platform would have to be considered in addition to the times presented above.

**B.4.1.6 Costs Associated with Sample Collection Activities**

Primary objective P7 involved estimating costs associated with Ekman Grab sample collection activities in S1A2 and S2A1. Because characteristics of these two areas are different, the sampling activities in these areas were expected to provide a range of costs involved in conducting sediment sampling using the Ekman Grab. For example, during the demonstration in S1A2, the average PCB concentration was about 310 parts per billion, and the water depth was about 2 feet. On the other hand, in S2A1, the average arsenic concentration was 120 mg/kg, and the water depth was about 18 feet.

The issues and assumptions discussed in Section 8.1 of the ITVR apply to this section as well except that unused sediment in S2A1 was assumed to be a hazardous waste. During the demonstration, the average arsenic concentration in the samples collected using the Ekman Grab was 120 mg/kg. Arsenic-contaminated wastes with TCLP extract concentrations greater than 5 mg/L must be disposed of as hazardous waste (40 CFR 261). Based on

**Table B-9. Time Required to Complete Sampling Activities for Ekman Grab**

Activity	Time Required (minutes)		
	S1A1 (River Mouth)	S1A2 (Freshwater Bay)	S2A1 (Lake)
Sampler setup	1	4	1
Sample collection	10	8	40
Sampler disassembly	1	3	1
Sampler decontamination	Not evaluated	22	13
<b>Total</b>	<b>12</b>	<b>37</b>	<b>55</b>

the average arsenic concentration and the dilution factor (20) associated with the TCLP, the TCLP extract concentration for the sediment waste generated during the demonstration was estimated to be about 6 mg/L. Therefore, unused sediment in S2A1 was assumed to be a hazardous waste.

This section presents information on sampler, labor, IDW disposal, and support equipment costs for the Ekman Grab as well as a summary of these costs. Table B-10 presents these costs.

**Sampler Cost**

In S1A2, the Ekman Grab was used with one 5-foot extension handle. The Ekman Grab and extension handle costs were \$304 and \$131, respectively. The total sampler cost for S1A2 was estimated to be \$435.

In S2A1, the Ekman Grab was used with one messenger and polyester line. The Ekman Grab and messenger costs were \$304 and \$52, respectively. The polyester line cost less than \$10 and therefore was not included in the estimate. The total sampler cost for S2A1 was estimated to be \$356.

**Labor Cost**

In S1A2, the time for sampler setup, sample collection, sampler disassembly, and sampler decontamination totaled 37 minutes or about 1 hour for one technician. In this area, five investigative samples for PCB analysis were collected using the Ekman Grab. Table B-3 presents additional information on the total number of samples collected. The labor cost for sampling in S1A2 was estimated to be \$34.

In S2A1, the time for sampler setup, sample collection, sampler disassembly, and sampler decontamination totaled 55 minutes or about 1 hour for one technician. In this area, ten investigative samples for arsenic analysis and five investigative samples for PSD analysis were collected using the Ekman Grab. Table B-3 presents additional information on the total number of samples collected. The labor cost for sampling in S2A1 was estimated to be \$34.

**IDW Disposal Cost**

Sampling in S1A2 generated IDW consisting of 15 L of unused sediment. The cost for disposal of one 55-gallon drum of nonhazardous waste is \$182.

Sampling in S2A1 generated IDW consisting of 7 L of unused sediment. The cost for disposal of one 55-gallon drum of hazardous waste is \$196.

**Support Equipment Cost**

Support equipment used during Ekman Grab sampling in S1A2 and S2A1 included a crescent wrench and a Phillips-head screwdriver. The costs of these items were not included in the estimate because a field sampling team would already have such tools as part of its field sampling gear.

**Summary of Ekman Grab Costs**

In summary, for the Ekman Grab, the costs to collect the numbers of samples listed in Table B-3 were estimated to be \$650 and \$590 for S1A2 and S2A1, respectively. Most of the costs were associated with the purchase of samplers (about 67 percent for S1A2 and 60 percent for S2A1) and IDW disposal (about 28 percent for S1A2 and 33 percent for S2A1).

**Table B-10. Ekman Grab Cost Summary**

Item	Quantity	Unit Cost (\$)	Total Cost (\$)
<b>S1A2 (Freshwater Bay) Costs</b>			
Sampler			
Ekman Grab	1 unit	304	304
Extension handle	1 unit	131	131
Labor	1 hour	34	34
IDW disposal	1 55-gallon drum	182	182
Support equipment	Not applicable	Not applicable	0
<b>Total<sup>a</sup></b>			<b>\$650</b>
<b>S2A1 (Lake) Costs</b>			
Sampler			
Ekman Grab	1 unit	304	304
Messenger	1 unit	52	52
Labor	1 hour	34	34
IDW disposal	1 55-gallon drum	196	196
Support equipment	Not applicable	Not applicable	0
<b>Total<sup>a</sup></b>			<b>\$590</b>

Notes:

IDW = Investigation-derived waste

<sup>a</sup> The total dollar amount is rounded to the nearest \$10.

### **B.4.2 Secondary Objectives**

This section describes the performance results for the Ekman Grab based on the secondary objectives specified in Section B.3.1. The secondary objectives were addressed based on observations of Ekman Grab performance during the demonstration.

#### **B.4.2.1 Skill and Training Requirements for Proper Sampler Operation**

The Ekman Grab is easy to operate, requiring minimal skills and training. Sampler assembly and sample collection procedures can be learned in the field with a few practice attempts. In addition, a written SOP accompanies the sampler when it is procured. The sampler can be operated by one person in shallow (wading) and deep water depths because of its lightness (10 lb, not including the weight of the extension handle). Sampler operation is simple because the sampler does not require complete disassembly and reassembly after each sampling attempt. Only the scoops or lids have to be opened in order to retrieve the sediment sample. The sampler

requires no support equipment unless a sampling platform is needed.

During the demonstration, minimal strength and stamina were required to deploy the sampler into and retrieve it from the 0- to 4-inch bss depth interval in S1A1, S1A2, and S2A1. Previous sediment sampling experience is beneficial in selecting the most appropriate optional accessories (such as the extension handle length or weight attachments) for a given Ekman Grab application. Previous sediment sampling experience is also beneficial for accurately assessing the location of the sediment surface using the sampler, as is the case using other samplers.

#### **B.4.2.2 Ability to Collect Samples Under a Variety of Site Conditions**

The Ekman Grab demonstrated the ability to collect sediment samples under all conditions encountered during the demonstration, which included a variety of sampling platforms, water depths, sediment depths, and sediment compositions. During the demonstration, the range of

platforms used included an 18-foot-long, 4-foot-wide Jon boat in S1A2; a sturdier, 30-foot-long, 8-foot-wide pontoon boat in S2A1; and the EPA GLNPO *Mudpuppy* in S1A1. Because the sampler does not require electricity or a tripod-mounted winch for deployment, sampler operation was feasible from any location on the sampling platforms used.

Because of the lightness of the sampler and extension handle (when needed), water depth had no significant impact on the sampling technician's ability to deploy and retrieve the sampler. In S1A2, the sampler was deployed and retrieved using a 5-foot-long extension handle because the water depth was about 2 feet. In S1A1 and S2A1, where water depths were about 6 and 18 feet, respectively, the sampler was deployed and retrieved using the polyester line and messenger. As with other samplers, the Ekman Grab's ability to accurately assess the location of the sediment surface decreases with increasing water depth and turbidity. Because of the significant water depth and turbidity in S1A1 and S2A1 and the significant turbidity in S1A2, the sampling technician could not see the sediment surface from the sampling platforms. An underwater video camera may have enabled the sampling technician to accurately assess the location of the sediment surface in these areas (Blomqvist 1991).

Water velocity had an impact on the sampling technician's ability to deploy the sampler when gravity penetration was used. As mentioned above, the sampler was deployed in S1A1 and S2A1 using the polyester line and messenger. During a few sampling attempts in each area, the current carried the sampler at least 1 foot beyond the desired sampling location near the sediment surface. The average water velocity in S1A1 and S2A1 was  $\leq 0.07$  ft/s and  $< 0.05$  ft/s, respectively. In S1A2, where the average water velocity was less than 0.05 ft/s, the sampler was deployed with a 5-foot-long extension handle because the water depth was only 2 feet. Because use of the extension handle provided more control during positioning of the sampler, water velocity had no significant impact on the sampling technician's ability to properly deploy the sampler.

The sampler was able to collect surficial sediment samples in all three demonstration areas. However, the sampler exhibited a few limitations related to sediment composition. As discussed in Section B.4.1.2 for primary

objective P2, the Ekman Grab performed poorly in terms of its ability to consistently collect sediment samples in a specified depth interval. In S1A1 and S2A1, low sediment recoveries were attributed to the failure of one or both of the scoops to close after the messenger was sent. In addition, in these areas, the sampling technician was unable to push the sampler into the sediment because the sampler was attached only to the polyester line. Therefore, the sampler may not have fully penetrated the target depth interval because the weight of the sampler may not have been adequate to overcome the degree of sediment compaction in these areas. In S1A2, the mean actual sediment sample thickness exceeded the target sediment sample thickness. The excessive sample thickness can be attributed to the sampling technician's pushing the sampler beyond the specified depth interval because of his difficulty in accurately assessing the location of the sediment surface using the sampler.

#### **B.4.2.3 Ability to Collect an Undisturbed Sample**

During the demonstration, as was expected given the nature of the sampler, the Ekman Grab did not consistently collect sediment samples in which the sediment stratification was preserved. Specifically, in S1A1 and S2A1, sediment stratification was not preserved. When the samples collected in these areas were discharged into stainless-steel bowls, the samples were unable to retain their form because of their high water content; as a result, sediment from different layers was allowed to mix. However, in S1A2, where the water content in the 0- to 4-inch bss depth interval was relatively low and the sediment contained a relatively high clay content, the samples were able to retain their form after discharge, and the sediment stratification was preserved.

The disturbance associated with bow wave formation near the water-sediment interface was not likely to be significant in S1A2 because the speed of sampler deployment was controlled by the use of the extension handle. However, in S1A1 and S2A1, the sampler was deployed using the polyester line; the sampler had to be dropped in order to allow gravity penetration into the target depth interval. As a result, the opportunity for bow wave formation was greater in these areas. However, because of the water depth and turbidity in both areas, the sampling technician was unable to observe whether bow wave formation occurred.

#### **B.4.2.4 Durability Based on Materials of Construction and Engineering Design**

As described in Section B.1.1, the Ekman Grab components are made of either stainless steel or galvanized steel. Based on observations made during the demonstration, the Ekman Grab is a sturdy sampler; none of the sampler components was damaged or required repair or replacement during the demonstration.

#### **B.4.2.5 Availability of Sampler and Spare Parts**

As mentioned above, no primary component of the Ekman Grab was damaged or required replacement during the demonstration. Had a primary sampler component (excluding the polyester line) required replacement, it would not have been available in a local retail store. Replacement components may be obtained from the developer by overnight courier in 2 days or less, depending on the location of the sampling site. The polyester line, which may need occasional replacement, should be available locally.

### ***B.4.3 Data Quality***

The overall QA objective for the demonstration was to produce well-documented data of known quality. The TSAs conducted to evaluate data quality did not reveal any problems that would make the demonstration data unusable. The scope of these TSAs is described in Sections 4.3 and 4.4 of this ITVR.

This section briefly discusses the data quality of demonstration results for the Ekman Grab; more detailed information is provided in the DER (Tetra Tech 1999a). Specifically, the data quality associated with the field measurement activities is discussed first, followed by the data quality associated with the laboratory analysis activities.

#### **B.4.3.1 Field Measurement Activities**

Field measurement activities conducted during the demonstration included measurement of the time associated with sample collection activities, water velocity, water depth, volume of IDW, volume of sediment collected in a given sampling attempt, and depth of sampler deployment. Of these measurement parameters, specific acceptance criteria were set for the

precision associated with the time and water velocity measurements only (EPA 1999). All time and water velocity measurements made during the demonstration met their respective criteria (see Table 6-7). Of the remaining parameters, some difficulties were encountered in measuring the volume of sediment collected in a given sampling attempt and the depth of sampler deployment, which are discussed below.

To measure the volume of sediment collected in a given sampling attempt, the sediment sample was transferred into a 2-L container graduated in increments of 20 mL. The container was tapped on a hard surface to minimize the presence of void spaces in the sample, the sample surface was made even using a spoon, and the volume of the sample was measured. However, because the void spaces could not be completely eliminated, the volumetric measurements are believed to have a positive bias that resulted in overestimation of PSRs. Because the total volume of the void spaces could not be measured, its impact on the PSR results could not be quantified.

The depth of sampler deployment was measured with reference to the sediment surface. To identify the location of the sediment surface, the sampling technician lowered the sampler into the water and used the bottom end of the sampler to feel the sediment surface. Subsequently, the technician used an extension rod to drive the sampler into the sediment to a depth that he estimated to be appropriate to collect a sediment sample or used a polyester line to allow the sampler to penetrate the sediment by gravity. Regardless of the method used to deploy the sampler, the technician could not control the depth of sampler deployment precisely; when the extension rod was used, the actual depth of sampler deployment exceeded the target depth of deployment by up to 2 inches, and when the polyester line was used, the sampler did not fully penetrate the target depth interval. Because of the nature of the Ekman Grab, when the actual depth of penetration was more than the target depth of penetration (as indicated by the volume of sediment sampled), the portion of the sediment sample associated with the excessive depth of penetration could not be removed from the sampler before the sediment volume was measured; consequently, the PSR results had a positive bias that could not be quantified.



### B.4.3.2 Laboratory Analysis Activities

The laboratory analyses conducted for the demonstration included the following: (1) PCB, arsenic, and PSD analyses of sediment samples and (2) PCB and arsenic analyses of equipment rinsate samples. To evaluate the data quality of the laboratory analysis results, field-generated QC samples, PE samples, and laboratory QC check samples were analyzed. The field-generated QC samples included the field replicates and temperature blanks described in Section 4.3 of this ITVR. The PE samples and laboratory QC check samples are described in Section 4.4. The acceptance criteria for the QC samples are presented in Table 6-7.

All temperature blanks and field replicates subjected to PCB and arsenic analyses met the acceptance criteria, indicating that the sample homogenization procedure (field replicates) and sample preservation procedure (temperature blanks) implemented in the field met the demonstration requirements. However, as stated in Section B.4.1.3, in a few cases the results of field triplicate sample analyses for PSD did not meet the acceptance criterion. Despite the failures to meet the acceptance criterion, the PSD results are considered to be valid for the reasons detailed in Section B.4.1.3.

The PE sample results for both the PCB and arsenic analyses met the acceptance criteria, indicating that the analytical laboratory accurately measured both PCBs and arsenic.

The analytical results for all laboratory QC check samples except the following met the acceptance criteria: (1) MS/MSD samples for analysis for PCBs in the sediment matrix and (2) equipment rinsate samples for PCB analysis. These issues and their likely impact on data quality are discussed below.

For the sediment matrix, in all MS/MSD samples analyzed for PCBs, Aroclor 1016 was recovered at levels higher than the upper limit of the acceptance criterion, indicating a positive bias in the PCB results for sediment samples. However, the analytical laboratory had no problem meeting the acceptance criteria for control samples such as BS/BSDs. For this reason, the failure to meet the acceptance criterion for MS/MSD sample analysis was attributed to matrix interference. The MS/MSD spiking compounds (Aroclors 1016 and 1260) were selected based

on the Aroclors detected during the predemonstration investigation and as recommended in SW-846 Method 8082.

Also for the sediment matrix, in one out of three MS/MSD pairs analyzed for PCBs, Aroclor 1260 was recovered at a level less than the lower limit of the acceptance criterion in the MS sample, but the recovery in the associated MSD sample was acceptable. Because the investigative samples contained only Aroclor 1242, of the two spiking compounds used to prepare the MS/MSD samples, only the Aroclor 1016 recoveries were considered to be relevant based on the PCB congener distribution; the Aroclor 1260 recoveries were not considered to be relevant. Therefore, the low recovery associated with Aroclor 1260 had no impact on data quality.

In all equipment rinsate samples analyzed for PCBs, decachlorobiphenyl (the surrogate) was recovered at levels lower than the lower limit of the acceptance criterion, indicating a negative bias in the PCB results for equipment rinsate samples. However, the analytical laboratory had no problem meeting the acceptance criteria for control samples such as PE samples and deionized water blanks. For this reason, the failure to meet the surrogate recovery acceptance criterion for the equipment rinsate sample analysis was attributed to matrix interference.

### B.5 References

- Analytical Software. 1996. Statistix<sup>®</sup> for Windows. Version 2.0. Tallahassee, Florida.
- Blomqvist, S. 1991. "Quantitative Sampling of Soft-Bottom Sediments: Problems and Solutions." *Marine Ecology Progress Series*. Volume 72. Pages 295 through 304.
- EPA. 1999. "Sediment Sampling Technologies Demonstration Plan." ORD. Washington, DC. April.
- Tetra Tech. 1999a. "Sediment Sampling Technologies Data Evaluation Report." Prepared for ORD, EPA. October.

## Appendix C Statistical Methods

This appendix summarizes two statistical methods used in evaluating the Split Core Sampler demonstration results: the Wilk-Shapiro test for evaluating whether data are normally or lognormally distributed (Section C.1) and the Wilcoxon signed rank test for evaluating whether two data sets are statistically different (Section C.2). Section C.3 lists references used to prepare this appendix. Examples of the use of the two tests are included in each test description. Both tests were performed using Statistix<sup>®</sup> developed by Analytical Software of Tallahassee, Florida (Analytical Software 1996).

### C.1 Wilk-Shapiro Test

The Wilk-Shapiro test is an effective method for testing whether a data set has been drawn from an underlying normal distribution. Furthermore, by conducting the test on the logarithms of the data, it is an equally effective way of evaluating the hypothesis of a lognormal distribution. This test was used to determine whether the demonstration results followed either the normal or lognormal distribution in order to use a parametric test, such as the Student's t-test, for evaluating the results for primary objectives P1, P2, and P4. The Wilk-Shapiro test results indicated that the data sets for P1, P2, and P4 were generally not normally distributed or could not be tested for lognormality because the results contained values that were equal to zero. Therefore, the Wilcoxon signed rank test, a nonparametric test for paired samples that makes no assumptions regarding the distribution, was used as an alternative to the Student's t-test.

For a given data set, the Statistix<sup>®</sup> software package first counts the number of values in the data set and then

generates the same number of expected values as if the data were perfectly, normally distributed. The expected values are generated using a standard normal distribution function (a standard normal distribution has a mean of 0 and a variance of 1). Both the actual and expected values are ranked in numerical order and plotted; the actual values (ordered data) are plotted on the y-axis, and the expected values (rankits) are plotted on the x-axis. The package performs a linear regression analysis and calculates the square of the correlation coefficient, also known as the approximate Wilk-Shapiro normality statistic (W). The W values can range from 0 to 1; 0 indicates no correlation between actual and expected values, and 1 indicates perfect correlation between actual and expected values.

The W values calculated for each data set were compared to critical W values corresponding to various significance levels ( $\alpha$ ) and sample sizes (Gilbert 1987). If the W value for a given data set was greater than the critical value listed for the corresponding sample size at  $\alpha=0.05$ , the data were assumed to be normally distributed. The examples discussed below illustrate this test.

Table C-1 presents two example data sets for primary objective P2 that were tested for normality. Figures C-1 and C-2 provide Statistix<sup>®</sup> Wilk-Shapiro test outputs for these data sets. The calculated W values for S1A2 and S2A2 were 0.9509 and 0.6740, respectively. At  $\alpha=0.05$ , the critical W values for S1A2 and S2A2 were 0.818 and 0.905, respectively. Because the calculated W value for S1A2 was greater than the critical W value, the S1A2 data for primary objective P2 were considered to be normally distributed. The opposite was true for S2A2 data.



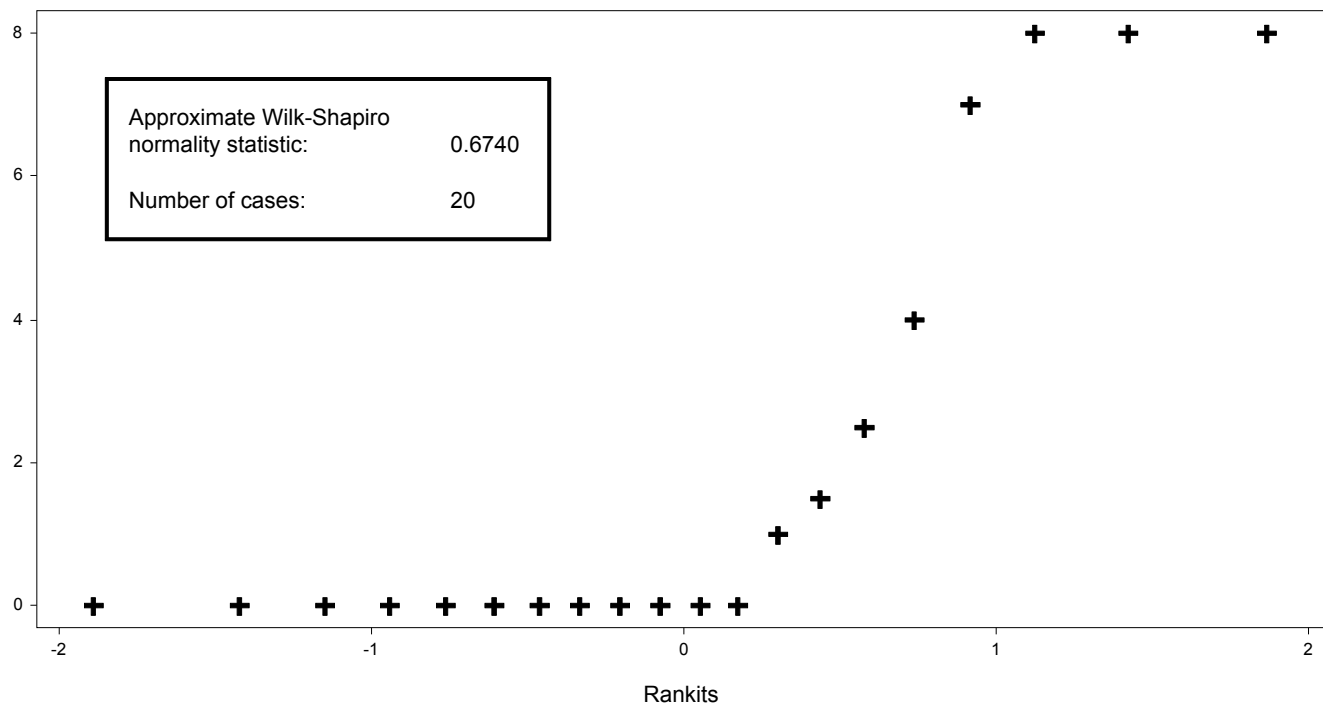

Figure C-2. Wilk-Shapiro test plot for core length measurements in S2A2 (wetland).

The Wilcoxon signed rank test was performed using the Statistix<sup>®</sup> software package, which calculated the probability value (p-value) at which the null hypothesis was true. The p-value was compared to an  $\alpha$  of 0.05 to determine whether the null hypothesis should be accepted or rejected. If the p-value exceeded  $\alpha$ , it was concluded that the mean difference for the paired results was not statistically significant; otherwise, it was concluded that the difference was statistically significant.

Several conclusions drawn from the Wilcoxon signed rank test results for primary objectives P1 and P2 did not seem to be correct based on the magnitude of the differences observed for sample pairs in a given data set. However, the results for primary objective P4 were evaluated using this test because no such problem was observed. To illustrate this point, example calculations are presented below.

Table C-2 and Figure C-3 provide the primary objective P1 Hand Corer sample data set for the 4- to 12-inch bss depth interval in S2A2 and the corresponding Statistix<sup>®</sup> output for the Wilcoxon signed rank test, respectively. The test calculated a one-tailed p-value of 0.0625,

indicating that the difference between the expected and actual number of attempts was not statistically significant (the null hypothesis was that the mean difference between the expected and actual values equals zero). Because the expected and actual values differed for four of the five sample pairs and particularly for the second pair, the difference was in fact considerable. Therefore, the conclusion drawn from the Wilcoxon signed rank test appears to be incorrect.

Table C-2. Hand Corer Sample Data for 4- to 12-Inch Below Sediment Surface Depth Interval in S2A2 (Wetland)

Expected Number of Attempts	Actual Number of Attempts
1	2
1	12
1	3
1	2
1	1

Table C-3 and Figure C-4 provide the primary objective P4 Hand Corer and Split Core Sampler sample data for the

**4- to 12-inch below sediment surface depth interval**

STATISTIX FOR WINDOWS		8/3/99, 4:44:45 PM
WILCOXON SIGNED RANK TEST FOR S2A2_4_12 - G		
SUM OF NEGATIVE RANKS		0.0000
SUM OF POSITIVE RANKS		10.000
EXACT PROBABILITY OF A RESULT AS OR MORE EXTREME THAN THE OBSERVED RANKS (1 TAILED P-VALUE)		0.0625
NORMAL APPROXIMATION WITH CONTINUITY CORRECTION TWO-TAILED P-VALUE for NORMAL APPROXIMATION		1.643 0.1003
TOTAL NUMBER OF VALUES THAT WERE TIED	2	
NUMBER OF ZERO DIFFERENCES DROPPED	1	
MAX. DIFF. ALLOWED BETWEEN TIES	0.00001	
CASES INCLUDED	4	MISSING CASES 6

**Figure C-3. Statistix® output for Hand Corer sample data for S2A2 (wetland).**

**Table C-3. Hand Corer and Split Core Sampler Sample Data for 10- to 30-inch Below Sediment Surface Depth Interval in S2A1 (Lake)**

Sampler	Arsenic Concentration (milligrams per kilogram)								
Hand Corer	24	8.5	16	8.3	9.7	7.2	7.2	8.2	52
Split Core Sampler	5.0	5.3	4.7	4.6	5.4	4.7	5.3	5.0	5.2

**10- to 30-inch below sediment surface depth interval**

STATISTIX FOR WINDOWS		8/19/99, 3:19:04 PM
WILCOXON SIGNED RANK TEST FOR REFERENCE - IS2		
SUM OF NEGATIVE RANKS		0.0000
SUM OF POSITIVE RANKS		45.000
EXACT PROBABILITY OF A RESULT AS OR MORE EXTREME THAN THE OBSERVED RANKS (1 TAILED P-VALUE)		0.0020
NORMAL APPROXIMATION WITH CONTINUITY CORRECTION TWO-TAILED P-VALUE for NORMAL APPROXIMATION		2.606 0.0092
TOTAL NUMBER OF VALUES THAT WERE TIED	2	
NUMBER OF ZERO DIFFERENCES DROPPED	0	
MAX. DIFF. ALLOWED BETWEEN TIES	0.00001	
CASES INCLUDED	9	MISSING CASES 0

**Figure C-4. Statistix® output for Hand Corer and Split Core Sampler sample data for S2A1 (lake).**

---

10- to 30-inch bss depth interval in S2A1 and the corresponding Statistix<sup>®</sup> output for the Wilcoxon signed rank test, respectively. The test calculated a two-tailed p-value of 0.0092, indicating that the difference between the two sets of arsenic results was statistically significant (the null hypothesis was that the mean difference between the innovative and reference sampler sample analytical results for the clean layer equals zero). Because the arsenic results for the Hand Corer samples were greater than those for the Split Core Sampler samples in each of the nine pairs, the conclusion drawn from the Wilcoxon signed rank test appears to be correct.

### C.3 References

- Analytical Software. 1996. Statistix<sup>®</sup> for Windows. Version 2.0. Tallahassee, Florida.
- Gilbert, R. 1987. *Statistical Methods for Environmental Pollution Monitoring*. Van Nostrand Reinhold Company, Inc. New York.