

US EPA ARCHIVE DOCUMENT



# Innovative Technology Verification Report

## Sediment Sampling Technology

### Aquatic Research Instruments Russian Peat Borer

US EPA ARCHIVE DOCUMENT



# Innovative Technology Verification Report

## Aquatic Research Instruments Russian Peat Borer

Prepared by

Tetra Tech EM Inc.  
Chicago, Illinois

Contract No. 68-C5-0037

Dr. Stephen Billets  
Environmental Sciences Division  
National Exposure Research Laboratory  
Office of Research and Development  
U.S. Environmental Protection Agency  
Las Vegas, Nevada 89193-3478



---

## Notice

This document was prepared for the U.S. Environmental Protection Agency (EPA) Superfund Innovative Technology Evaluation Program under Contract No. 68-C5-0037. The document has been subjected to the EPA's peer and administrative reviews and has been approved for publication. Mention of corporation names, trade names, or commercial products does not constitute endorsement or recommendation of specific products for use.



## ENVIRONMENTAL TECHNOLOGY VERIFICATION PROGRAM VERIFICATION STATEMENT

TECHNOLOGY TYPE:	<b>SEDIMENT SAMPLER</b>
APPLICATION:	<b>CORE SAMPLING OF SEDIMENT</b>
TECHNOLOGY NAME:	<b>AQUATIC RESEARCH INSTRUMENTS RUSSIAN PEAT BORER</b>
COMPANY:	<b>AQUATIC RESEARCH INSTRUMENTS</b>
ADDRESS:	<b>1 HAYDEN CREEK ROAD LEMHI, IDAHO 83466</b>
WEB SITE:	<b><a href="http://www.aquaticresearch.com">http://www.aquaticresearch.com</a></b>
TELEPHONE:	<b>(208) 756-8433</b>

### VERIFICATION PROGRAM DESCRIPTION

The U.S. Environmental Protection Agency (EPA) created the Superfund Innovative Technology Evaluation (SITE) and Environmental Technology Verification (ETV) Programs to facilitate deployment of innovative technologies through performance verification and information dissemination. The goal of these programs is to further environmental protection by substantially accelerating the acceptance and use of improved and cost-effective technologies. These programs assist and inform those involved in design, distribution, permitting, and purchase of environmental technologies. This document summarizes results of a demonstration of the Russian Peat Borer designed and fabricated by Aquatic Research Instruments.

### PROGRAM OPERATION

Under the SITE and ETV Programs, with the full participation of the technology developers, the EPA evaluates and documents the performance of innovative technologies by developing demonstration plans, conducting field tests, collecting and analyzing demonstration data, and preparing reports. The technologies are evaluated under rigorous quality assurance (QA) protocols to produce well-documented data of known quality. The EPA National Exposure Research Laboratory, which demonstrates field sampling, monitoring, and measurement technologies, selected Tetra Tech EM Inc. as the verification organization to assist in field testing two sediment sampling technologies. This demonstration was funded by the SITE Program.

### DEMONSTRATION DESCRIPTION

In April and May 1999, the EPA conducted a field demonstration of the Russian Peat Borer along with one other sediment sampler. This verification statement focuses on the Russian Peat Borer; a similar statement has been prepared for the other sampler. The performance and cost of the Russian Peat Borer were compared to those of two conventional samplers (the Hand Corer and Vibrocorer), which were used as reference samplers. To verify a wide range of performance attributes, the Russian Peat Borer demonstration had both primary and secondary objectives. Primary objectives for this demonstration included evaluating the sampler's ability to (1) consistently collect a given volume of sediment, (2) consistently collect sediment in a given depth interval, (3) collect samples with consistent characteristics from a homogenous layer of sediment, (4) collect a representative sample from a clean sediment layer below a contaminated sediment layer, and (5) be adequately decontaminated. Additional primary objectives were to measure sampling time and estimate sampling costs. Secondary objectives included (1) documenting the skills and training required for sampler operation, (2) evaluating the sampler's ability to collect samples under a variety of site conditions, (3) assessing the sampler's ability to collect an undisturbed sample, (4) evaluating sampler durability, and (5) documenting the availability of the sampler and its spare parts. To ensure data usability, data quality indicators for precision, accuracy, representativeness, completeness, and comparability were also assessed based on project-specific QA objectives.

The Russian Peat Borer was demonstrated at sites in EPA Regions 1 and 5. At the Region 1 site, the sampler was demonstrated in a lake and wetland. At the Region 5 site, the sampler was demonstrated in a river mouth and freshwater bay. Collectively, the two sites provided multiple sampling areas with the different water depths, sediment types, sediment contaminant characteristics, and sediment thicknesses necessary to properly evaluate the sampler. Based on the predemonstration investigation results, demonstration objectives, and site support facilities available, (1) the Hand Corer was used as the reference sampler in the lake, wetland, and freshwater bay and (2) the Vibrocorer was used as the reference sampler in the river mouth. A complete description of the demonstration and a summary of its results are available in the "Innovative Technology Verification Report: Sediment Sampling Technology—Aquatic Research Instruments Russian Peat Borer" (EPA/600/R-01/010).

## TECHNOLOGY DESCRIPTION

The Russian Peat Borer is a manually driven, chambered-type, side-filling core sampler designed to collect discrete, relatively uncompressed sediment samples. Sampler components include a stainless-steel core tube, aluminum extension rods, a stainless-steel turning handle, and a Delrin<sup>®</sup> core head and bottom point that support a stainless-steel cover plate. The cover plate and bottom point are sharpened to minimize sediment disturbance during sampler deployment. The core tube is hinged to the cover plate by two pivot pins at the top and bottom of the plate. Support equipment for the sampler may include a slide-hammer mechanism to aid sampler deployment and retrieval in consolidated sediment. To collect a sediment sample, the Russian Peat Borer is manually inserted into sediment, and the core tube is turned 180 degrees clockwise. This procedure allows the core tube to rotate and its sharp edge to longitudinally cut through the sediment, collecting a semicylindrical sediment core. While the core tube is manually turned, the stainless-steel cover plate provides support so that the collected material is retained in the core tube.

## VERIFICATION OF PERFORMANCE

Key demonstration findings are summarized below for the primary objectives.

***Consistently Collecting a Given Volume of Sediment:*** In the shallow depth interval (0 to 4 inches below sediment surface [bss]), to collect a specified number of samples, the Russian Peat Borer required 33 percent more attempts than expected (65 actual versus 49 expected), whereas the reference samplers required 14 percent more attempts than expected (49 actual versus 43 expected). In the moderate depth interval (4 to 32 inches bss), the Russian Peat Borer required 21 percent more attempts than expected (46 actual versus 38 expected), but the reference samplers required 156 percent more attempts than expected (64 actual versus 25 expected).

For the shallow depth interval, mean sample recoveries ranging from 71 to 84 percent were achieved by the Russian Peat Borer, whereas mean sample recoveries for the reference samplers ranged from 85 to 100 percent. The variation in sample recoveries as measured by their relative standard deviations (RSD) ranged from 26 to 42 percent for the Russian Peat Borer, whereas the reference samplers' RSDs ranged from 0 to 33 percent. For the moderate depth interval, mean sample recoveries ranging from 75 to 101 percent were achieved by the Russian Peat Borer, whereas the reference samplers' mean sample recoveries ranged from 21 to 82 percent. The RSDs for the Russian Peat Borer ranged from 6 to 31 percent, whereas the reference samplers' RSDs ranged from 3 to 161 percent. (Note: sample recoveries exceeding 100 percent resulted from the volumetric measurement error associated with the presence of void spaces when the sediment was transferred to a graduated container.)

***Consistently Collecting Sediment in a Given Depth Interval:*** The Russian Peat Borer collected samples in all depth intervals and demonstration areas, which contained various sediment types. The reference samplers were unable to collect samples in the deep depth interval (4 to 11 feet bss). For the shallow depth interval, the Russian Peat Borer's actual core lengths equaled the target core length in 98 percent of the total sampling attempts. The reference samplers' actual core lengths equaled the target core length in 94 percent of the total sampling attempts. However, the results for the samplers were significantly different for the moderate depth interval: 93 percent for the Russian Peat Borer compared to 13 percent for the reference samplers.

***Collecting Samples with Consistent Characteristics from a Homogenous Layer of Sediment:*** Based on particle size distribution results, both the Russian Peat Borer and reference samplers collected samples with consistent physical characteristics from two homogenous layers of sediment (a sandy silt layer and a clayey silt layer).

***Collecting a Representative Sample from a Clean Sediment Layer Below a Contaminated Sediment Layer:*** The Russian Peat Borer collected samples from a clean sediment layer below a contaminated sediment layer that were at least as representative as the samples collected from the clean layer by the reference sampler (the Hand Corer); contaminant concentrations in the samples collected by both samplers were not statistically different at a significance level of 0.05.

**Sampler Decontamination:** Both the Russian Peat Borer and reference samplers demonstrated the ability to be adequately decontaminated after sampling in areas contaminated with either polychlorinated biphenyls or arsenic.

**Sampling Time:** Compared to the reference samplers, the Russian Peat Borer not only was able to collect samples in all depth intervals and demonstration areas but also reduced sampling time by 16 to 77 percent, depending on the area.

**Sampling Costs:** Of the sampling costs estimated for two of the four areas sampled, in one area the sampling costs for the Russian Peat Borer were 90 percent less than those for the reference sampler (the Vibrocorer), and in the other area the sampling costs for the Russian Peat Borer were 22 percent more than those for the reference sampler (the Hand Corer).

Key demonstration findings are summarized below for the secondary objectives.

**Skill and Training Requirements:** The Russian Peat Borer, like the Hand Corer, is easy to operate and requires minimal skills and training. However, operation of the Vibrocorer is relatively complicated and requires moderate skills and training. The Russian Peat Borer was operated by one person, whereas the Hand Corer was operated by one or two persons and the Vibrocorer was operated by two persons. When more than two extension rods were required, the Hand Corer was operated using a tripod-mounted winch. The Vibrocorer operation required a motor-operated winch, whereas the Russian Peat Borer was operated without a winch throughout the demonstration.

**Sampling Under a Variety of Site Conditions:** The Russian Peat Borer collected samples in all depth intervals and demonstration areas, which contained various sediment types. The reference samplers were unable to collect samples in the deep depth interval (4 to 11 feet bss). Neither the Russian Peat Borer nor the Hand Corer requires a power supply. In contrast, the Vibrocorer requires a three-phase, 230- or 440-volt, 50- to 60-hertz power supply, which is a sampler limitation if the power supply fails.

**Collecting an Undisturbed Sample:** The Russian Peat Borer collected representative core samples of consolidated sediment in discrete depth intervals. Visual observations indicated that these samples were relatively uncompressed. In addition, the Russian Peat Borer collected sediment samples containing live biota. The reference samplers collected relatively compressed core samples of both consolidated and unconsolidated sediments from the sediment surface downward. In moderate and deep depth intervals, samples collected by the reference samplers may be of questionable representativeness because of core shortening and core compression. In the samples collected by the Russian Peat Borer, sediment stratification was preserved for consolidated sediment but not for unconsolidated sediment. Sediment stratification was preserved for both consolidated and unconsolidated sediments in the samples collected by the reference samplers.

**Sampler Durability and Availability:** Based on their materials of construction and engineering designs, both the Russian Peat Borer and reference samplers are considered to be sturdy. The Russian Peat Borer and its support equipment are not expected to be available in local retail stores. Similarly, the primary components of the Hand Corer and Vibrocorer are not expected to be available in local retail stores; extension rods for the Hand Corer may be locally available.

Based on the demonstration results, the Russian Peat Borer can be operated by one person with minimal skills and training and does not require support equipment such as a winch and power source even when collecting sediment samples at depths up to 11 feet bss. The sampler can collect representative and relatively uncompressed samples of consolidated sediment in discrete depth intervals. The sampler preserves sediment stratification in consolidated sediment samples, but sediment stratification may not be preserved in unconsolidated sediment samples. The Russian Peat Borer is a superior alternative to conventional sediment samplers, particularly for sampling consolidated sediment. As with any sampler selection, the user must determine the appropriate sampler for a given application based on project-specific data quality objectives.

Gary J. Foley, Ph.D.  
Director  
National Exposure Research Laboratory  
Office of Research and Development

**NOTICE:** EPA verifications are based on an evaluation of technology performance under specific, predetermined criteria and appropriate quality assurance procedures. The EPA makes no expressed or implied warranties as to the performance of the technology and does not certify that a technology will always operate as verified. The end user is solely responsible for complying with any and all applicable federal, state, and local requirements.



---

## Foreword

The U.S. Environmental Protection Agency (EPA) is charged by Congress with protecting the nation's natural resources. Under the mandate of national environmental laws, the agency strives to formulate and implement actions leading to a compatible balance between human activities and the ability of natural systems to support and nurture life. To meet this mandate, the EPA Office of Research and Development provides data and scientific support that can be used to solve environmental problems, build the scientific knowledge base needed to manage ecological resources wisely, understand how pollutants affect public health, and prevent or reduce environmental risks.

The National Exposure Research Laboratory (NERL) is the agency's center for investigation of technical and management approaches for identifying and quantifying risks to human health and the environment. Goals of the laboratory's research program are to (1) develop and evaluate methods and technologies for characterizing and monitoring air, soil, and water; (2) support regulatory and policy decisions; and (3) provide the scientific support needed to ensure effective implementation of environmental regulations and strategies.

The EPA Superfund Innovative Technology Evaluation (SITE) Program evaluates technologies designed for characterization and remediation of contaminated Superfund and Resource Conservation and Recovery Act sites. The SITE Program was created to provide reliable cost and performance data in order to speed acceptance and use of innovative remediation, characterization, and monitoring technologies by the regulatory and user community.

Effective measurement and monitoring technologies are needed to assess the degree of contamination at a site, provide data that can be used to determine the risk to public health or the environment, supply the necessary cost and performance data to select the most appropriate technology, and monitor the success or failure of a remediation process. One component of the EPA SITE Program, the Monitoring and Measurement Technology (MMT) Program, demonstrates and evaluates innovative technologies to meet these needs.

Candidate technologies can originate within the federal government or the private sector. Through the SITE Program, developers are given the opportunity to conduct a rigorous demonstration of their technologies under actual field conditions. By completing the demonstration and distributing the results, the agency establishes a baseline for acceptance and use of these technologies. The MMT Program is administered by the Environmental Sciences Division of NERL in Las Vegas, Nevada.

Gary J. Foley, Ph.D.  
Director  
National Exposure Research Laboratory  
Office of Research and Development



---

## Abstract

The Russian Peat Borer designed and fabricated by Aquatic Research Instruments was demonstrated under the U.S. Environmental Protection Agency (EPA) Superfund Innovative Technology Evaluation Program in April and May 1999 at sites in EPA Regions 1 and 5, respectively. In addition to assessing ease of sampler operation, key objectives of the demonstration included evaluating the sampler's ability to (1) consistently collect a given volume of sediment, (2) consistently collect sediment in a given depth interval, (3) collect samples with consistent characteristics from a homogenous layer of sediment, and (4) collect samples under a variety of site conditions. This report describes the demonstration results for the Russian Peat Borer and two conventional samplers (the Hand Corer and Vibrocorer) used as reference samplers. During the demonstration, the Russian Peat Borer was the only sampler that collected samples in the deep depth interval (4 to 11 feet below sediment surface). It collected representative and relatively uncompressed core samples of consolidated sediment in discrete depth intervals. The reference samplers collected relatively compressed samples of both consolidated and unconsolidated sediments from the sediment surface downward; sample representativeness may be questionable because of core shortening and core compression. Sediment stratification was preserved only for consolidated sediment samples collected by the Russian Peat Borer but for both unconsolidated and consolidated sediment samples collected by the reference samplers. Sampling time was less for the Russian Peat Borer than for the reference samplers. Sampling costs for the Russian Peat Borer were 90 percent less than those for the Vibrocorer and 22 percent more than those for the Hand Corer.

## Contents

<u>Chapter</u>	<u>Page</u>
Notice .....	ii
Verification Statement .....	iii
Foreword .....	vi
Abstract .....	vii
Figures .....	xiii
Tables .....	xv
Abbreviations, Acronyms, and Symbols .....	xvii
Acknowledgments .....	xix
1 Introduction .....	1
1.1 Description of the SITE Program .....	1
1.2 Scope of the Demonstration .....	4
2 Description of the Innovative Sediment Sampler .....	5
2.1 Sampler Description .....	5
2.2 General Operating Procedures .....	7
2.3 Advantages and Limitations .....	8
2.4 Developer Contact Information .....	8
3 Demonstration Site Descriptions .....	9
3.1 EPA Region 5 Site (Site 1) .....	9
3.1.1 Site 1, Area 1 .....	9
3.1.2 Site 1, Area 2 .....	10
3.2 EPA Region 1 Site (Site 2) .....	11
3.2.1 Site 2, Area 1 .....	11
3.2.2 Site 2, Area 2 .....	11
4 Demonstration Approach .....	12
4.1 Demonstration Objectives .....	12

---

## Contents (Continued)

<u>Chapter</u>		<u>Page</u>
4.2	Demonstration Design .....	13
4.3	Field Sampling and Measurement Procedures .....	16
4.4	Laboratory Sample Preparation and Analysis Methods .....	22
5	Description of the Reference Sediment Samplers .....	25
5.1	Hand Corer .....	25
5.1.1	Technology Description .....	25
5.1.2	General Operating Procedures .....	26
5.1.3	Advantages and Limitations .....	27
5.2	Vibrocorer .....	27
5.2.1	Technology Description .....	27
5.2.2	General Operating Procedures .....	28
5.2.3	Advantages and Limitations .....	29
6	Performance of the Russian Peat Borer .....	30
6.1	Primary Objectives .....	30
6.1.1	Ability to Consistently Collect a Specified Volume of Sediment .....	31
6.1.1.1	Number of Sampling Attempts Required .....	31
6.1.1.2	Volume of Sediment Collected .....	33
6.1.2	Ability to Consistently Collect Sediment in a Specified Depth Interval .....	37
6.1.3	Ability to Collect Multiple Samples with Consistent Physical or Chemical Characteristics, or Both, from a Homogenous Layer of Sediment .....	39
6.1.4	Ability to Collect a Representative Sample from a Clean Sediment Layer Below a Contaminated Sediment Layer .....	40
6.1.5	Ability to be Adequately Decontaminated .....	44
6.1.6	Time Requirements for Sample Collection Activities .....	44
6.2	Secondary Objectives .....	45
6.2.1	Skill and Training Requirements for Proper Sampler Operation .....	45
6.2.2	Ability to Collect Samples Under a Variety of Site Conditions .....	46
6.2.3	Ability to Collect an Undisturbed Sample .....	47
6.2.4	Durability Based on Materials of Construction and Engineering Design .....	47
6.2.5	Availability of Sampler and Spare Parts .....	48
6.3	Data Quality .....	48
6.3.1	Field Measurement Activities .....	48
6.3.2	Laboratory Analysis Activities .....	49
7	Performance of the Reference Samplers .....	52
7.1	Primary Objectives .....	52
7.1.1	Ability to Consistently Collect a Specified Volume of Sediment .....	53
7.1.1.1	Number of Sampling Attempts Required .....	53
7.1.1.2	Volume of Sediment Collected .....	55

---

## Contents (Continued)

<u>Chapter</u>		<u>Page</u>
	7.1.2 Ability to Consistently Collect Sediment in a Specified Depth Interval . . . . .	57
	7.1.3 Ability to Collect Multiple Samples with Consistent Physical or Chemical Characteristics, or Both, from a Homogenous Layer of Sediment . . . . .	59
	7.1.4 Ability to be Adequately Decontaminated . . . . .	62
	7.1.5 Time Requirements for Sample Collection Activities . . . . .	62
7.2	Secondary Objectives . . . . .	64
	7.2.1 Skill and Training Requirements for Proper Sampler Operation . . . . .	64
	7.2.2 Ability to Collect Samples Under a Variety of Site Conditions . . . . .	65
	7.2.3 Ability to Collect an Undisturbed Sample . . . . .	66
	7.2.4 Durability Based on Materials of Construction and Engineering Design . . . . .	66
	7.2.5 Availability of Sampler and Spare Parts . . . . .	66
7.3	Data Quality . . . . .	67
	7.3.1 Field Measurement Activities . . . . .	67
	7.3.2 Laboratory Analysis Activities . . . . .	68
8	Economic Analysis . . . . .	69
8.1	Issues and Assumptions . . . . .	69
	8.1.1 Sampler Costs . . . . .	69
	8.1.2 Labor Costs . . . . .	69
	8.1.3 IDW Disposal Costs . . . . .	70
	8.1.4 Support Equipment Costs . . . . .	70
	8.1.5 Costs Not Included . . . . .	70
8.2	Russian Peat Borer Costs . . . . .	71
	8.2.1 Sampler Cost . . . . .	72
	8.2.2 Labor Cost . . . . .	72
	8.2.3 IDW Disposal Cost . . . . .	73
	8.2.4 Support Equipment Cost . . . . .	73
	8.2.5 Summary of Russian Peat Borer Costs . . . . .	73
8.3	Hand Corer Costs . . . . .	73
	8.3.1 Sampler Cost . . . . .	74
	8.3.2 Labor Cost . . . . .	74
	8.3.3 IDW Disposal Cost . . . . .	74
	8.3.4 Support Equipment Costs . . . . .	74
	8.3.5 Summary of Hand Corer Costs . . . . .	74
8.4	Vibrocorer Costs . . . . .	75
	8.4.1 Sampler Cost . . . . .	75
	8.4.2 Labor Cost . . . . .	75
	8.4.3 IDW Disposal Cost . . . . .	75
	8.4.4 Support Equipment Cost . . . . .	75
	8.4.5 Summary of Vibrocorer Costs . . . . .	75
8.5	Comparison of Economic Analysis Results . . . . .	75

---

## Contents (Continued)

<u>Chapter</u>		<u>Page</u>
9	Summary of Demonstration Results .....	77
9.1	Primary Objectives .....	77
9.2	Secondary Objectives .....	82
10	References .....	83
Appendix A	Developer's Claims for the ARI Russian Peat Borer .....	85
Appendix B	Performance and Cost of the Ekman Grab .....	89
B.1	Description of the Ekman Grab .....	89
B.1.1	Sampler Description .....	89
B.1.2	General Operating Procedures .....	90
B.1.3	Advantages and Limitations .....	91
B.2	Description of the Demonstration Sites .....	91
B.3	Demonstration Approach .....	91
B.3.1	Demonstration Objectives .....	91
B.3.2	Demonstration Design .....	92
B.3.3	Field Sampling and Measurement Procedures .....	93
B.4	Performance of the Ekman Grab .....	95
B.4.1	Primary Objectives .....	95
B.4.1.1	Ability to Consistently Collect a Specified Volume of Sediment .....	96
B.4.1.2	Ability to Consistently Collect Sediment in a Specified Depth Interval .....	98
B.4.1.3	Ability to Collect Multiple Samples with Consistent Physical or Chemical Characteristics, or Both, from a Homogenous Layer of Sediment .....	99
B.4.1.4	Ability to be Adequately Decontaminated .....	100
B.4.1.5	Time Requirements for Sample Collection Activities .....	100
B.4.1.6	Costs Associated with Sample Collection Activities .....	102
B.4.2	Secondary Objectives .....	104
B.4.2.1	Skill and Training Requirements for Proper Sampler Operation .....	104
B.4.2.2	Ability to Collect Samples Under a Variety of Site Conditions .....	105
B.4.2.3	Ability to Collect an Undisturbed Sample .....	105
B.4.2.4	Durability Based on Materials of Construction and Engineering Design .....	106
B.4.2.5	Availability of Sampler and Spare Parts .....	106
B.4.3	Data Quality .....	106
B.4.3.1	Field Measurement Activities .....	106
B.4.3.2	Laboratory Analysis Activities .....	107
B.5	References .....	107

---

## Contents (Continued)

<u>Chapter</u>		<u>Page</u>
Appendix C	Statistical Methods .....	109
C.1	Wilk-Shapiro Test .....	109
C.2	Wilcoxon Signed Rank Test .....	110
C.3	References .....	113

## Figures

<u>Figure</u>	<u>Page</u>
2-1. Russian Peat Borer .....	6
4-1. Site 1 sampling locations .....	17
4-2. Site 2 sampling locations .....	18
5-1. Hand Corer .....	26
5-2. Vibrocorer .....	28
6-1. Percent sample recoveries for Russian Peat Borer at Site 1 .....	34
6-2. Percent sample recoveries for Russian Peat Borer at Site 2 .....	35
6-3. Russian Peat Borer sample particle size distribution results for S1A2 (freshwater bay) .....	40
6-4. Russian Peat Borer sample arsenic and particle size distribution results for S2A1 (lake) .....	41
6-5. Comparison of Russian Peat Borer and reference sampler sample arsenic concentration results for S2A1 (lake) .....	43
7-1. Percent sample recoveries for Vibrocorer and Hand Corer at Site 1 .....	55
7-2. Percent sample recoveries for Hand Corer at Site 2 .....	56
7-3. Hand Corer sample particle size distribution results for S1A2 (freshwater bay) .....	60
7-4. Hand Corer sample arsenic and particle size distribution results for S2A1 (lake) .....	61
B-1. Ekman Grab .....	90
B-2. Sampling locations for Ekman Grab demonstration .....	94
B-3. Percent sample recoveries for Ekman Grab in S1A1 (river mouth), S1A2 (freshwater bay), and S2A1 (lake) .....	99
B-4. Ekman Grab sample analytical results for S1A1 (river mouth) and S2A1 (lake) .....	101
C-1. Wilk-Shapiro test plot for core length measurements in S1A2 (freshwater bay) .....	110
C-2. Wilk-Shapiro test plot for core length measurements in S2A2 (wetland) .....	111
C-3. Statistix <sup>®</sup> output for Hand Corer sample data for S2A2 (wetland) .....	112



---

## Figures (Continued)

<u>Figure</u>	<u>Page</u>
C-4. Statistix <sup>®</sup> output for Hand Corer and Russian Peat Borer sample data for S2A1 (lake) .....	113

**Tables**

<u>Table</u>	<u>Page</u>
2-1. Russian Peat Borer Model Specifications .....	7
3-1. Demonstration Area Characteristics .....	10
4-1. Innovative Sediment Sampler Demonstration Design .....	14
4-2. Rationale for Sampling Approach .....	19
4-3. Sample Matrix .....	21
4-4. Laboratory Sample Preparation and Analysis Methods .....	23
4-5. Laboratory Quality Control Checks .....	24
6-1. Comparison of Expected and Actual Number of Sampling Attempts for Russian Peat Borer at Site 1 .....	32
6-2. Comparison of Expected and Actual Number of Sampling Attempts for Russian Peat Borer at Site 2 .....	33
6-3. Percent Sample Recovery Summary Statistics for Russian Peat Borer .....	36
6-4. Comparison of Target and Actual Core Length Data for Russian Peat Borer .....	38
6-5. Particle Size Distribution Summary Statistics for Russian Peat Borer .....	42
6-6. Time Required to Complete Sampling Activities for Russian Peat Borer .....	44
6-7. Summary of Quality Control Checks and Acceptance Criteria for Field and Laboratory Parameters .....	50
7-1. Comparison of Expected and Actual Number of Sampling Attempts for Reference Samplers at Site 1 .....	53
7-2. Comparison of Expected and Actual Number of Sampling Attempts for Reference Sampler at Site 2 .....	54
7-3. Percent Sample Recovery Summary Statistics for Reference Samplers .....	57
7-4. Comparison of Target and Actual Core Length Data for Reference Samplers .....	58
7-5. Particle Size Distribution Summary Statistics for Hand Corer .....	62
7-6. Time Required to Complete Sampling Activities for Reference Samplers .....	63

**Tables (Continued)**

<u>Table</u>	<u>Page</u>
8-1. Comparison of Investigation-Derived Waste Quantities Generated by Russian Peat Borer and Reference Samplers .....	70
8-2. Russian Peat Borer Cost Summary .....	72
8-3. Hand Corer Cost Summary for S2A1 (Lake) .....	73
8-4. Vibrocorer Cost Summary for S1A1 (River Mouth) .....	74
8-5. Comparison of Costs for Russian Peat Borer and Reference Samplers .....	76
9-1. Summary of Results for Primary Objectives .....	78
9-2. Summary of Results for Secondary Objectives .....	80
B-1. Ekman Grab Demonstration Design .....	92
B-2. Rationale for Sampling Approach .....	95
B-3. Ekman Grab Sample Matrix .....	96
B-4. Comparison of Expected and Actual Number of Sampling Attempts for Ekman Grab at Site 1 .....	97
B-5. Comparison of Expected and Actual Number of Sampling Attempts for Ekman Grab in S2A1 (Lake) .....	97
B-6. Percent Sample Recovery Summary Statistics for Ekman Grab .....	98
B-7. Comparison of Target and Actual Sediment Thickness Data for Ekman Grab .....	100
B-8. Particle Size Distribution Summary Statistics for Ekman Grab .....	102
B-9. Time Required to Complete Sampling Activities for Ekman Grab .....	103
B-10. Ekman Grab Cost Summary .....	104
C-1. Data Sets for Example Wilk-Shapiro Test Calculations .....	110
C-2. Hand Corer Sample Data for 4- to 12-Inch Below Sediment Surface Depth Interval in S2A2 (Wetland) .....	111
C-3. Hand Corer and Russian Peat Borer Sample Data for 10- to 30-Inch Below Sediment Surface Depth Interval in S2A1 (Lake) .....	112

---

## Abbreviations, Acronyms, and Symbols

>	Greater than
≤	Less than or equal to
±	Plus or minus
<	Less than
ARI	Aquatic Research Instruments
ASTM	American Society for Testing and Materials
BS/BSD	Blank spike/blank spike duplicate
bss	Below sediment surface
CFR	<i>Code of Federal Regulations</i>
cm	Centimeter
DER	Data evaluation report
EPA	U.S. Environmental Protection Agency
ETV	Environmental Technology Verification
FLAA	Flame atomic absorption
ft	Foot
ft/s	Foot per second
GLNPO	Great Lakes National Program Office
ICP	Inductively coupled argon plasma
IDW	Investigation-derived waste
ITVR	Innovative technology verification report
L	Liter
lb	Pound
m	Meter
mg/kg	Milligram per kilogram
mg/L	Milligram per liter
mL	Milliliter
MMT	Monitoring and Measurement Technology
MS/MSD	Matrix spike/matrix spike duplicate
NA	Not applicable
NERL	National Exposure Research Laboratory
ORD	Office of Research and Development
OSWER	Office of Solid Waste and Emergency Response
PCB	Polychlorinated biphenyl
PE	Performance evaluation
PSD	Particle size distribution
PSR	Percent sample recovery
QA	Quality assurance
QA/QC	Quality assurance/quality control
QC	Quality control

---

## Abbreviations, Acronyms, and Symbols (Continued)

RPD	Relative percent deviation
RSD	Relative standard deviation
S1A1	Site 1, Area 1
S1A2	Site 1, Area 2
S2A1	Site 2, Area 1
S2A2	Site 2, Area 2
SITE	Superfund Innovative Technology Evaluation
SOP	Standard operating procedure
Statistix®	Statistix® for Windows, Version 2.0
TCLP	Toxicity characteristic leaching procedure
Tetra Tech	Tetra Tech EM Inc.
TSA	Technical system audit

---

## Acknowledgments

This report was prepared for the U.S. Environmental Protection Agency (EPA) Superfund Innovative Technology Evaluation (SITE) Program under the direction and coordination of Dr. Stephen Billets and Dr. Brian Schumacher of the EPA National Exposure Research Laboratory—Environmental Sciences Division in Las Vegas, Nevada. The SITE Program thanks Mr. Joseph LeMay and Mr. Andy Beliveau of EPA Region 1, Mr. Robert Paulson of the Wisconsin Department of Natural Resources, and Mr. Marc Tuchman and Mr. Scott Cieniawski of the EPA Great Lakes National Program Office for their support in conducting field activities for this project. Mr. Jonathan Kuhns of Hawk Consulting and Dr. Larry Jackson of Environmental Quality Management served as the peer reviewers of this report.

This report was prepared for the EPA by Dr. Kirankumar Topudurti, Mr. Eric Monschein, and Mr. Andrew Bajorat of Tetra Tech EM Inc. Special acknowledgment is given to Ms. Jeanne Kowalski, Mr. Jon Mann, Mr. Stanley Labunski, Ms. Sandy Anagnostopoulos, Ms. Amy Stephen, Mr. Gary Sampson, and Mr. Bob Overman for their assistance during the preparation of this report.

---

## Chapter 1 Introduction

The U.S. Environmental Protection Agency (EPA) Office of Research and Development's (ORD) National Exposure Research Laboratory (NERL) has conducted a demonstration of an innovative sediment sampler known as the Russian Peat Borer, a core sampler designed and fabricated by Aquatic Research Instruments (ARI) of Lemhi, Idaho. The demonstration was conducted under the EPA Superfund Innovative Technology Evaluation (SITE) Program at two sites during the last week of April and first week of May 1999. The purpose of this demonstration was to obtain reliable performance and cost data on the Russian Peat Borer in order to (1) achieve a better understanding of the sampler's capabilities relative to conventional sediment samplers and (2) provide an opportunity for the sampler to enter the marketplace and compete with conventional samplers without long delays.

This innovative technology verification report (ITVR) presents the performance results of the demonstration and associated costs for the Russian Peat Borer. Specifically, this report describes the SITE Program and the scope of the demonstration (Chapter 1), innovative sediment sampler that was demonstrated (Chapter 2), two demonstration sites (Chapter 3), demonstration approach (Chapter 4), conventional sediment samplers used as reference samplers during the demonstration (Chapter 5), performance of the innovative sampler (Chapter 6), performance of the reference samplers (Chapter 7), economic analysis for the innovative and reference samplers (Chapter 8), demonstration results in summary form (Chapter 9), and references used to prepare the ITVR (Chapter 10). ARI claims for, updates on, and information on previous deployments of the innovative sampler are provided in Appendix A. Appendix B presents performance results for the Ekman Grab, a conventional grab sampler that was included in the

demonstration because grab samplers are commonly used to collect surficial sediment in order to assess the horizontal distribution of sediment characteristics. Appendix C describes the statistical methods used, as appropriate, to address the primary objectives for the demonstration.

### 1.1 Description of the SITE Program

Performance verification of innovative environmental technologies is an integral part of the regulatory and research mission of the EPA. The SITE Program was established by the EPA Office of Solid Waste and Emergency Response (OSWER) and ORD under the Superfund Amendments and Reauthorization Act of 1986. The primary purpose of the SITE Program is to promote acceptance and use of innovative sampling, monitoring, measurement, and treatment technologies.

The overall goal of the SITE Program is to conduct research and performance verification studies of innovative technologies that may be used to achieve long-term protection of human health and the environment. The various components of the SITE Program are designed to encourage development, demonstration, acceptance, and use of innovative sampling, monitoring, measurement, and treatment technologies. The program is designed to meet four primary objectives: (1) identify and remove obstacles to development and commercial use of innovative technologies, (2) support a development program that identifies and nurtures emerging technologies, (3) demonstrate promising innovative technologies to establish reliable performance and cost information for site characterization and cleanup decision-making, and (4) develop procedures and policies that encourage use of innovative technologies at Superfund sites as well as at other waste sites and commercial facilities.



The intent of a SITE demonstration is to obtain representative, high-quality performance and cost data on one or more innovative technologies so that potential users can assess a given technology's suitability for a specific application. The SITE Program includes the following elements:

- **Monitoring and Measurement Technology (MMT) Program**—Evaluates technologies that sample, detect, monitor, and measure hazardous and toxic substances. These technologies are expected to provide better, faster, and more cost-effective methods for producing real-time data during site characterization and remediation studies than do conventional technologies.
- **Remediation Technology Program**—Conducts demonstrations of innovative treatment technologies to provide reliable performance, cost, and applicability data for site cleanups.
- **Technology Transfer Program**—Provides and disseminates technical information in the form of updates, brochures, and other publications that promote the SITE Program and technologies. It also offers technical assistance, training, and workshops to support the technologies.

The innovative sediment sampler demonstration was conducted as part of the MMT Program, which provides developers of innovative hazardous waste sampling, monitoring, and measurement technologies with an opportunity to demonstrate their technologies' performance under actual field conditions. These technologies may be used to sample, detect, monitor, or measure hazardous and toxic substances in soil, sediment, waste material, or groundwater. The technologies include chemical sensors for in situ (in place) measurements, groundwater samplers, soil and sediment samplers, soil gas samplers, laboratory and field-portable analytical equipment, and other systems that support field sampling or data acquisition and analysis.

The MMT Program promotes acceptance of technologies that can be used to accurately assess the degree of contamination at a site, provide data to evaluate potential effects on human health and the environment, apply data to assist in selecting the most appropriate cleanup action, and monitor the effectiveness of a remediation process. The program places a high priority on innovative

technologies that provide more cost-effective, faster, and safer methods for producing real-time or near-real-time data than do conventional technologies. These innovative technologies are demonstrated under field conditions, and the results are compiled, evaluated, published, and disseminated by ORD. The primary objectives of the MMT Program are as follows:

- Test field sampling and analytical technologies that enhance sampling, monitoring, and site characterization capabilities
- Identify performance attributes of innovative technologies to address field sampling, monitoring, and characterization problems in a more cost-effective and efficient manner
- Prepare protocols, guidelines, methods, and other technical publications that enhance acceptance of these technologies for routine use

The MMT Program is administered by the Environmental Sciences Division of NERL in Las Vegas, Nevada. The NERL is the EPA's center for investigation of technical and management approaches for identifying and quantifying risks to human health and the environment. The NERL's mission components include (1) developing and evaluating methods and technologies for sampling, monitoring, and characterizing water, air, soil, and sediment; (2) supporting regulatory and policy decisions; and (3) providing the technical support needed to ensure effective implementation of environmental regulations and strategies. By demonstrating selected innovative sediment samplers, the MMT Program is supporting development and evaluation of methods and technologies for sampling and characterizing sediment.

The MMT Program's technology performance verification process is designed to conduct demonstrations that will generate high-quality data that potential users can employ to verify technology performance and cost. Four key steps are inherent in the process: (1) needs identification and technology selection, (2) demonstration planning and implementation, (3) report preparation, and (4) information distribution.

The first step of the technology performance verification process begins with identifying technology needs of the EPA and regulated community. The EPA regional offices, the U.S. Department of Energy, the U.S. Department of

Defense, industry, and state environmental regulatory agencies are asked to identify technology needs for sampling, monitoring, and measurement of environmental media. Once a need is identified, a search is conducted to identify suitable technologies that will address the need. The technology search and identification process consists of examining industry and trade publications, attending related conferences, exploring leads from technology developers and industry experts, and reviewing responses to *Commerce Business Daily* announcements. Selection of technologies for field testing includes evaluation of the candidate technologies based on several criteria. A suitable technology for field testing

- Is designed for use in the field
- Is applicable to a variety of environmentally contaminated sites
- Has potential for solving problems that current methods cannot satisfactorily address
- Has estimated costs that are competitive with those of current methods
- Is likely to achieve better results than current methods in areas such as data quality and turnaround time
- Uses techniques that are easier and safer than current methods
- Is commercially available

Once candidate technologies are identified, their developers are asked to participate in a developer conference. This conference gives the developers an opportunity to describe their technologies' performance and to learn about the MMT Program.

The second step of the technology performance verification process is to plan and implement a demonstration that will generate high-quality data that potential users can employ to verify technology performance and cost. Demonstration planning activities include a predemonstration sampling and analysis investigation that assesses existing conditions at the proposed demonstration site or sites. The objectives of the predemonstration investigation are to (1) confirm available information on applicable physical, chemical,

and biological characteristics of contaminated media at the sites to justify selection of site areas for the technology demonstration; (2) provide the technology developers with an opportunity to evaluate the areas and identify logistical requirements; (3) determine the overall logistical requirements for conducting the demonstration; and (4) provide the analytical laboratories with an opportunity to identify any matrix-specific analytical problems associated with contaminated media and propose appropriate solutions. Information generated through the predemonstration investigation is used to develop the demonstration design and sampling and analysis procedures.

Demonstration planning activities also include preparation of a demonstration plan that describes the procedures to be used to verify the performance and cost of each innovative technology. The demonstration plan incorporates information generated during the predemonstration investigation as well as input from technology developers and demonstration site representatives. The demonstration plan also incorporates the quality assurance and quality control (QA/QC) elements needed to produce data of sufficient quality to document the performance and cost of each technology.

During the technology performance verification process, each innovative technology is evaluated independently and, when possible, against a reference technology. The performance of a developer or innovative technology is not compared to that of another developer or innovative technology. Rather, demonstration data are used to evaluate the performance, cost, advantages, limitations, and field applicability of each technology.

As part of the third step of the technology performance verification process, the EPA publishes a verification statement and a detailed evaluation of each technology in an ITVR. To ensure its quality, the ITVR is published only after comments from the technology developer and external peer reviewers are satisfactorily addressed. All demonstration data used to evaluate each innovative technology are summarized in a data evaluation report (DER) that constitutes a record of the demonstration. The DER is not published by the EPA, but an unpublished copy may be obtained by contacting the EPA project manager, Dr. Stephen Billets.

The fourth step of the technology performance verification process is to distribute demonstration information. The

EPA distributes ITVRs free of charge through direct mailings, at conferences, and on the Internet to benefit technology developers and potential technology users. ITVRs are available on the Internet through the Hazardous Waste Clean-Up Information web site supported by the EPA OSWER Technology Innovation Office (<http://www.clu-in.org>). Additional information on the SITE Program is provided at the ORD web site (<http://www.epa.gov/ORD/SITE>).

## 1.2 Scope of the Demonstration

Environmental sediment sampling is conducted to characterize sediment at a particular location. Sediment characterization may involve biological analyses (for biological availability and benthic biota), chemical analyses (for organic and inorganic contaminants), and physical analyses (for color, texture, and particle size distribution [PSD]). Sediment samplers are typically designed to collect discrete samples of sufficient quantity and quality at a predetermined depth relatively easily and in a reasonable amount of time. Although the samplers now being used meet most sediment sampling requirements, innovative samplers may be faster and easier to operate, less expensive, and more accurate and precise.

The MMT Program members involved in the Russian Peat Borer demonstration included the EPA NERL, the EPA National Risk Management Research Laboratory, EPA Region 1, the Wisconsin Department of Natural Resources, the EPA Great Lakes National Program Office (GLNPO), and ARI.

The performance of the Russian Peat Borer was demonstrated and compared to that of conventional sediment samplers in order to provide evidence that the Russian Peat Borer worked as intended and to facilitate its use. The conventional sediment samplers, which are referred to as reference samplers herein, are described in Chapter 5. For the demonstration, either a Hand Corer or a Vibrocorer was used as a reference sampler, depending on site conditions and sampler availability.

In addition to the Russian Peat Borer, ARI was given the opportunity to substitute one alternate innovative sampler if ARI believed that the alternate sampler was better suited for the conditions and objectives being addressed

in a particular sampling area. However, ARI elected not to demonstrate an alternate innovative sampler.

A conventional grab sampler was also included in the demonstration because grab samplers are commonly used to collect surficial sediment in order to assess the horizontal distribution of sediment characteristics. The Ekman Grab, a commonly used grab sampler, was chosen for the demonstration. Performance and cost data collected for the Ekman Grab are not be compared to those for the Russian Peat Borer but rather are presented in Appendix B as supplemental information.

The demonstration had both primary and secondary objectives. The primary objectives were critical to the technology evaluation and required use of quantitative results to draw conclusions regarding technology performance. The secondary objectives pertained to information that was useful but did not necessarily require use of quantitative results to draw conclusions regarding technology performance. Based on available historical data for the demonstration sites, the primary objectives required use of chemical and physical characterization of sediment but not biological characterization. The primary and secondary objectives are presented in Chapter 4.

To meet the demonstration objectives, individual areas at two sites were selected for conducting the demonstration. The first site is referred to as Site 1; it included two areas and lies in EPA Region 5. The second site is referred to as Site 2; it included two areas and lies in EPA Region 1. These sites and areas are described in Chapter 3.

In preparation for the demonstration, a predemonstration sampling and analysis investigation was completed at the two sites in February 1999. The purpose of this investigation was to assess whether the sites were appropriate for evaluating the Russian Peat Borer based on the demonstration objectives. The demonstration was conducted during the last week of April and first week of May 1999. The procedures used to verify the performance and cost of the Russian Peat Borer are summarized in a demonstration plan completed in April 1999 (EPA 1999). The demonstration plan also incorporates the QA/QC elements needed to generate data of sufficient quality to document innovative and reference sampler performance and cost. The plan is available on the Internet through the ORD web site (<http://www.epa.gov/ORD/SITE>).

---

## Chapter 2

### Description of the Innovative Sediment Sampler

Core samplers are commonly used to collect sediment profiles in order to assess the vertical distribution of sediment characteristics. Based on the method of sample collection, core samplers may be broadly classified into two categories: (1) end-filling core samplers and (2) side-filling core samplers (Faegri and Iversen 1989). An end-filling sampler typically consists of one or more core tubes or a box that collects sediment from the bottom end of the sampler as it is pushed through the sediment. An end-filling sampler generally collects sediment from the sediment surface down to a particular depth. Once the core sample is extruded through the end of the sampler, a discrete depth interval of the core sample may be subsampled. Examples of end-filling samplers include the Hand Corer, Split Core Sampler, Dual Tube Liner Sampler, and Vibrocorer. Additional details on end-filling samplers are provided by Environment Canada (1994), Blomqvist (1991), Faegri and Iversen (1989), Aaby and Digerfeldt (1986), and Downing (1984).

A side-filling core sampler is operated by first driving the sampler to a particular depth. The core tube is then rotated clockwise to fill the tube by cutting out a segment of sediment. A large cover plate attached to the core tube holds the sampler stationary while the tube rotates clockwise to collect the sediment. Resistance offered by the sediment keeps the cover plate stationary, allowing the core tube to rotate. Examples of side-filling samplers include the Russian sampler and the Hiller sampler (Faegri and Iversen 1989). The Russian sampler was described first by Belokopytov and Beresnevich (1955) and later by Jowsey (1966). Additional details on the Hiller sampler are provided by Faegri and Iversen (1989) and Aaby and Digerfeldt (1986).

This chapter describes the Russian Peat Borer designed and fabricated by ARI. ARI developed the Russian Peat

Borer during the early 1990s, improving on similar Russian samplers that have been used since the 1950s. Sections 2.1 through 2.4 describe the Russian Peat Borer, discuss its general operating procedures, outline its advantages and limitations, and provide developer contact information. Similar information for the reference samplers used during the demonstration is provided in Chapter 5.

#### 2.1 Sampler Description

Components of the Russian Peat Borer include (1) a stainless-steel, chambered-type core tube; (2) 40-inch-long, 1-inch-diameter, aluminum extension rods; (3) a stainless-steel turning handle; and (4) a Delrin<sup>®</sup> core head and bottom point that support a stainless-steel cover plate (see Figure 2-1). The cover plate is curved and sharpened to minimize disturbance when the sampler is inserted into sediment. The core tube is hinged to the cover plate by two stainless-steel pivot pins at the top and bottom of the plate. Support equipment for operation of the sampler may include a slide-hammer mechanism and 10-foot-long, 1.3-inch-diameter, magnesium-zirconium extension rods. The Russian Peat Borer is readily available in three models whose specifications are presented in Table 2-1. ARI will also manufacture Russian Peat Borers of different design specifications upon request.

Site-specific sampling requirements should be considered during selection of the most appropriate Russian Peat Borer model for a given application. For example, Model A (with its 2-inch-inside diameter, 20-inch-long core tube) encounters the least resistance during sampler deployment and retrieval through the sediment because of its short length and small turning radius. As a result, this model may be selected to collect samples in deep depth intervals, where the degree of sediment compaction is



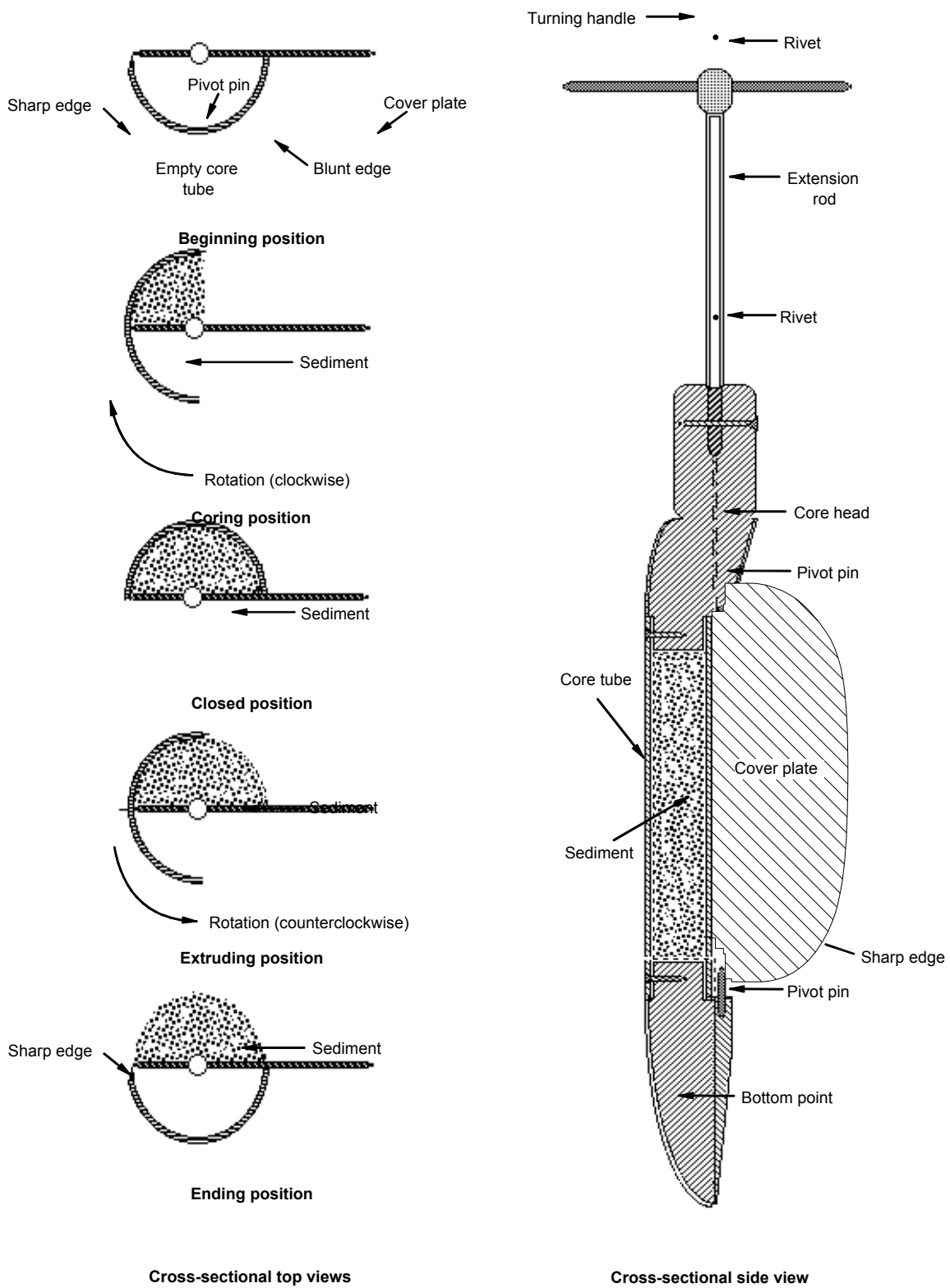

Figure 2-1. Russian Peat Borer.

**Table 2-1. Russian Peat Borer Model Specifications**

Model <sup>a</sup>	Core Tube			Design Volume Per Inch <sup>b</sup> (mL)	Weight <sup>c</sup> (lb)
	Length (inches)	Inside Diameter (inches)	Volume (mL)		
A	20	2	500	26	5.5
B	40	2	1,050	26	15
C	25	3	1,450	58	14

Notes:

lb = Pound  
mL = Milliliter

- <sup>a</sup> The model designations are specific to this report and are not used in the developer's product catalog.
- <sup>b</sup> The design volume is the maximum volume of sediment that the sampler can collect per unit length of core tube (1 inch); for a given target depth interval, the design volume corresponds to 100 percent sample recovery.
- <sup>c</sup> The weight shown does not include extension rods; each 40-inch-long, 1-inch-diameter, aluminum extension rod weighs about 2 lb.

expected to be high. Model B (with its 2-inch-inside diameter, 40-inch-long core tube) may be selected to collect sediment in both shallow and moderate depth intervals because of its greater length and ability to collect sediment in both intervals in one attempt. Model C (with its 3-inch-inside diameter, 25-inch-long core tube) may be selected to collect sediment in situations requiring larger sample volume because of its larger core tube diameter.

The Russian Peat Borer is manually inserted into sediment in the beginning position, and the core tube is turned 180 degrees clockwise until the sharp edge of the tube contacts the cover plate. This procedure allows the core tube to rotate and the sharp edge to longitudinally cut through the sediment, collecting a semicylindrical sediment core. Resistance offered by the sediment holds the cover plate stationary, allowing the core tube to rotate. The cover plate also provides support so that the collected material is retained in the core tube.

The Russian Peat Borer is innovative because the core head and bottom point are made of Delrin<sup>®</sup>, a self-lubricating, thermoplastic polymer that has a high modulus of elasticity as well as strength, stiffness, and resistance to abrasion and the degrading effects of moisture. Earlier sediment samplers with a similar design typically were made entirely of stainless steel and therefore were heavy; the use of Delrin<sup>®</sup> has made the sampler lighter. In addition, ARI limited the

thickness of the stainless-steel cover plate and the core tube to 2 millimeters in order to minimize the resistance created by the sediment during sampler deployment and core tube rotation. ARI also designed the aluminum extension rods to be light in weight and to float in water. Finally, according to ARI, the optional, 10-foot-long, 1.3-inch-diameter, magnesium-zirconium rods available for sampler deployment to depths greater than 50 feet below sediment surface (bss) are durable, light in weight, and easily coupled and uncoupled.

## 2.2 General Operating Procedures

The Russian Peat Borer can be operated by one person from a platform, from a boat, or while wading in shallow water. Figure 2-1 presents a five-stage depiction of the Russian Peat Borer operating procedures. The sampler is operated by manually inserting the bottom point of the sampler into the sediment with the blunt edge of the core tube turned against the cover plate to prevent sediment from entering the tube during penetration. A slide-hammer mechanism can be used to drive the sampler through highly consolidated sediment or peat that is hard to penetrate. The sampling technician should practice sampler deployment to determine whether a slide-hammer is needed.

Once the sampler is driven into the sediment to the desired depth, the turning handle is manually turned 180 degrees clockwise, allowing the sharpened edge of the core tube to longitudinally cut through the sediment, collecting a

semicylindrical sediment core. The sampler reaches the closed position once the sharp edge of the core tube is in contact with the cover plate. Once it is in the closed position, the sampler can be manually retrieved. As the sampler is retrieved within the sediment, a constant, clockwise pressure on the sampler is required to ensure that the core tube remains in the closed position. As the sampler is dislodged from the sediment, the sampler is retrieved in such a way that the cover plate is above the core tube. As a result, gravity pulls down on the cover plate, further ensuring that the core tube remains in the closed position. The sampler is turned progressively more horizontal as it nears the water surface, reaching about a 45-degree angle as it is removed from the water. The sampler is positioned horizontally immediately thereafter. The sampler is then rotated and placed on the sampling platform in such a way that the core tube is above the cover plate. The core tube is then manually turned counterclockwise, rotating the tube and exposing the semicylindrical core sample on the cover plate.

To allow consecutive, complete reconstruction of a long sediment profile, two Russian Peat Borers can be alternately deployed side-by-side to alternating depths. This procedure allows continuous core samples to be collected sequentially, with one sampler remaining in the sediment as a sample is collected using the other sampler. This procedure is designed to minimize disturbance of the sediment while ensuring that a complete, continuous sediment core is collected.

### 2.3 Advantages and Limitations

An advantage of the Russian Peat Borer is that it is easy to operate, requiring minimal skills and training. Although ARI currently does not have a training video or written standard operating procedure (SOP), sampler assembly and collection procedures can be learned in the field with a few practice attempts. The sampler can be operated by one person because of its lightness (see Table 2-1). Sampler operation is simple because it has only one moving part (the core tube rotates 180 degrees). Moreover, the sampler does not require disassembly to extrude the sample and reassembly after each sampling attempt. The sampler requires no support equipment other than two sawhorses for supporting the sampler during sample extrusion, a slide-hammer mechanism, and a safe sampling platform.

The Russian Peat Borer also has the unique ability to collect discrete, relatively uncompressed core samples from shallow to deep depth intervals without disturbing the sediment stratification. In addition, when only deep core samples are required, the amount of investigation-derived waste (IDW) generated is minimized because the Russian Peat Borer is a discrete sampler.

A limitation of the Russian Peat Borer is that the sampler requires extension rods for deployment in deep water applications. In addition, the sampler is not equipped with disposable core liners. During sampler deployment, the cover plate is exposed to different layers of sediment contamination. Contaminants may adhere to the exposed surface of the cover plate while the sampler passes through different layers of sediment, increasing the risk of cross-contamination between sampling depth intervals. However, the sampling technician has the option to discard the portion of the sediment core near the cover plate if necessary based on project-specific requirements.

Another limitation of the Russian Peat Borer is that during sampling, partially decomposed plant matter or small stones may become caught between the core tube and the cover plate, causing the core tube to remain in the open position during sampler retrieval and resulting in sediment washout. Furthermore, collection of a sediment sample using the sampler requires that the sediment offer enough resistance (support) to keep the cover plate stationary and allow rotation of the core tube.

### 2.4 Developer Contact Information

Additional information about the Russian Peat Borer can be obtained from the following source:

Mr. Will Young  
Aquatic Research Instruments  
1 Hayden Creek Road  
Lemhi, ID 83466  
Telephone: (208) 756-8433  
Fax: (208) 756-8435  
E-mail: hydrobio@aol.com  
Internet: www.aquaticresearch.com



## Chapter 3 Demonstration Site Descriptions

This chapter discusses the two sites selected for conducting the Russian Peat Borer demonstration. The first site is referred to as Site 1 and includes two areas along a river in EPA Region 5. The second site is referred to as Site 2 and includes two areas along a river in EPA Region 1. After a review of the information available on these and other candidate sites, Sites 1 and 2 were selected based on the following criteria:

- **Site Diversity**—Each site consisted of multiple sampling areas with the different water depths, flow regimes, sediment types, sediment contaminant characteristics, and sediment thicknesses necessary to evaluate the Russian Peat Borer.
- **Access and Cooperation**—Site representatives were interested in supporting the demonstration by providing historical data and site access.

In February 1999, a predemonstration sampling and analysis investigation was conducted to assess existing site conditions and to confirm information provided by EPA Regions 1 and 5. The predemonstration investigation results summarized in Table 3-1 were used to develop the demonstration design for the innovative and reference samplers. The following sections provide brief descriptions of the two demonstration sites.

### 3.1 EPA Region 5 Site (Site 1)

Site 1 consists of sections of a river in EPA Region 5. Two areas along the river were selected as demonstration areas. These areas and the sampling platforms used are briefly described below and shown in Figure 4-1.

#### 3.1.1 Site 1, Area 1

Site 1, Area 1 (S1A1) lies at the river mouth, which is about 0.5 mile wide. The area generally represents an open-water condition. During the demonstration, the average water velocity in this area was less than or equal to 0.07 foot per second (ft/s). The water depth in the vicinity of S1A1 ranged from about 5 to 6 feet. Sampling in S1A1 was conducted using the EPA GLNPO's *Mudpuppy*, a 32-foot-long, 8-foot-wide, twin-motor, flat-bottom boat specifically designed for sediment sampling in rivers and harbors. The boat is equipped with a vibrocoring unit supported by an A-frame and winch that allows collection of sediment cores up to 15 feet long. Additional features that make the *Mudpuppy* a suitable platform for conducting vibrocoring or other sediment sampling include the following:

- A sampling platform at the bow of the boat with a hole in the middle wide enough to accommodate the vibrocoring unit
- Adequate deck space for subsampling and processing 15-foot-long core samples
- A differentially corrected global positioning system with submeter accuracy that allows precise and accurate determination of sampling locations
- Four anchor lines for maintaining the boat's position over sampling locations
- An electrical power source for support equipment

Table 3-1. Demonstration Area Characteristics

Demonstration Area	Average Water Velocity <sup>a</sup> (ft/s)	Water Depth <sup>a</sup> (ft)	Predemonstration Investigation Results		
			Target Sampling Depth Interval (inches bss)	Contaminant	Physical Characteristics
S1A1 (river mouth)	≤ 0.07	5 to 6	0 to 4	PCBs	Unconsolidated sediment containing primarily sand with some silt and little clay
			4 to 12	PCBs	Consolidated sediment containing primarily sand and silt with some clay
S1A2 (freshwater bay)	< 0.05	2	0 to 6	PCBs	Unconsolidated sediment containing primarily sand and silt with some clay
			12 to 36	None <sup>b</sup>	Consolidated sediment containing primarily silt with some sand and clay
S2A1 (lake)	< 0.05	18	0 to 4	Arsenic	Unconsolidated sediment containing primarily silt with some sand and clay
			10 to 30	Arsenic	Consolidated sediment containing primarily sand with some silt and little clay
S2A2 (wetland)	< 0.05 to 0.7	0.5 to 1.5	4 to 12	Arsenic	Consolidated sediment containing primarily sand with some silt and little clay

Notes:

- ≤ = Less than or equal to                      ft = Foot
- < = Less than                                      ft/s = Foot per second
- bss = Below sediment surface                PCB = Polychlorinated biphenyl

<sup>a</sup> Average water velocity and water depth represent data collected during the actual demonstration.

<sup>b</sup> No measurable PCB contamination was present in this depth interval.

Predemonstration investigation sample analytical results for S1A1 indicated that polychlorinated biphenyl (PCB) contamination in the 0- to 4-inch bss depth interval was minimal. However, the 4- to 12-inch bss depth interval in this area had the highest levels of PCB contamination of any depth interval sampled during the predemonstration investigation. Based on the PSD data, sediment in the 0- to 4-inch bss depth interval was predominantly sand with some silt and little clay. PSD in the 4- to 12-inch bss depth interval was predominantly sand and silt with some clay. Sediment in the 0- to 4-inch bss depth interval was unconsolidated and became increasingly consolidated below this depth interval. During the demonstration, a clay hardpan was encountered at about 5 feet bss in the sampling area. Based on the PCB and PSD data from the predemonstration investigation, the sediment in the 0- to 4-inch bss depth interval in S1A1 appeared to be chemically and physically homogenous. However, the sediment in the 4- to 12-inch bss depth interval in this area did not appear to be as chemically or physically homogenous as was the case in Site 1, Area 2 (S1A2).

### 3.1.2 Site 1, Area 2

S1A2 is about 11 miles upstream of S1A1. The river is about 2,000 feet wide in S1A2. A small, protected bay is present along the river channel's bank at this location. This bay has a very slow-moving current and, because of its configuration, backflow conditions. During the demonstration, the average water velocity in the area of the bay was less than 0.05 ft/s. The water depth in the bay was about 2 feet. Sampling in S1A2 was conducted within the bay using an 18-foot-long, 4-foot-wide, flat-bottom Jon boat. The boat was equipped with a single engine, a set of oars, and a single anchor line for positioning the boat over sampling locations. The *Mudpuppy* could not be used to conduct sampling in S1A2 because the water in this area was too shallow (the *Mudpuppy* requires a minimum water depth of about 3 feet).

Predemonstration investigation sample analytical results for S1A2 indicated that PCB contamination in the 0- to 6-inch bss depth interval was minimal but greater than that

in the 0- to 4-inch bss depth interval in S1A1. Furthermore, the 12- to 36-inch bss depth interval in S1A2 had no measurable PCB contamination. Sediment in the 0- to 6-inch bss depth interval was predominantly sand and silt with some clay. Sediment in the 12- to 36-inch bss depth interval was predominantly silt with some sand and clay. Sediment in the top few inches was unconsolidated and became consolidated with increasing depth. Based on the PSD data from the predemonstration investigation, sediment in the 12- to 36-inch bss depth interval in S1A2 appeared to be the most physically homogenous at Site 1.

### 3.2 EPA Region 1 Site (Site 2)

Site 2 consists of sections of a river in EPA Region 1. The river, which has a moderate flow, runs through a low-lying wetland area and empties into a lake. Two areas along the river were selected as demonstration areas. These areas and the sampling platforms used are briefly described below and are shown in Figure 4-2.

#### 3.2.1 Site 2, Area 1

Site 2, Area 1 (S2A1) is a lake located about 5 miles downstream of Site 2, Area 2 (S2A2). During the demonstration, the average water velocity in the area was less than 0.05 ft/s, and the water depth was about 18 feet. Sampling in S2A1 was conducted using a 30-foot-long, 8-foot-wide pontoon boat. The pontoon boat was equipped with a single engine and eight anchor lines for positioning the boat over sampling locations. In addition, a 6-inch-diameter hole was provided in the middle of the boat to allow use of a core sampler with a tripod-mounted winch. The front and sides of the boat would not accommodate a tripod-mounted winch.

Predemonstration investigation sample analytical results for S2A1 indicated that the 0- to 4-inch bss depth interval in this area had more consistent and higher levels of arsenic contamination and more consistent PSD than was the case in S2A2. Arsenic contamination in the 0- to 4-inch bss depth interval in S2A1 was an order of magnitude greater than that in the 10- to 30-inch bss depth interval. Sediment in the 0- to 4-inch bss depth interval

was predominantly silt with some sand and clay. Sediment in the 0- to 4-inch bss depth interval was unconsolidated and became increasingly consolidated below this depth interval. Sediment in the 10- to 30-inch bss depth interval was predominantly sand with some silt and little clay. Based on the arsenic and PSD data from the predemonstration investigation, the sediment in the 10- to 30-inch bss depth interval in S2A1 appeared to be the most chemically and physically homogenous sediment at Site 2.

#### 3.2.2 Site 2, Area 2

S2A2 is a low-lying wetland along the river. This area is about 5 miles upstream of S2A1. The river channel is about 10 feet wide in S2A2. Water flow in this area is low to moderate, reflecting seasonal variations. During the demonstration, the average water velocity in the area ranged from less than 0.05 to 0.7 ft/s, and water depths in the area ranged from about 0.5 to 1.5 feet. Sampling in S2A2 was conducted from wood planks fastened to two aluminum ladders extended across the river channel. Depending on the individual needs of each sampling technician, (1) samples were collected off the side of one ladder or (2) the sampling technician stood with one foot on each ladder to collect samples between the ladders.

At the time of the predemonstration investigation, the top 4 to 8 inches of sediment in S2A2 contained organic matter, primarily decomposed leaves and wood chips. Predemonstration investigation sample analytical results for S2A2 indicated that levels of arsenic contamination from the bottom of the organic layer down to 12 inches bss were nonuniform and lower than the levels in S2A1. In S2A2, sediment in the 4- to 12-inch bss depth interval (below the organic layer) was predominantly sand with some silt and little clay. Sediment in this depth interval was highly consolidated. Based on the arsenic and PSD data from the predemonstration investigation, S2A2 did not appear to be as chemically or physically homogenous as S2A1. In addition, historical data provided by EPA Region 1 indicated that a 30-foot-thick layer of peat existed below the sediment layer in S2A2.

## Chapter 4 Demonstration Approach

This chapter presents the demonstration objectives (Section 4.1), design (Section 4.2), field sampling and measurement procedures (Section 4.3), and laboratory sample preparation and analysis methods (Section 4.4).

### 4.1 Demonstration Objectives

The main intent of the SITE MMT Program is to develop reliable performance and cost data on innovative technologies. A SITE demonstration must provide detailed and reliable performance and cost data so that potential technology users have adequate information to make sound judgments regarding a technology's applicability to a specific site and to compare the technology to alternatives.

The Russian Peat Borer demonstration had both primary and secondary objectives. Primary objectives were critical to the technology evaluation and required use of quantitative results to draw conclusions regarding technology performance. Secondary objectives pertained to information that was useful but did not necessarily require use of quantitative results to draw conclusions regarding technology performance.

The primary objectives for the innovative sediment sampler demonstration were as follows:

- P1. Evaluate whether the sampler can consistently collect a specified volume of sediment
- P2. Determine whether the sampler can consistently collect samples in a specified depth interval
- P3. Assess the sampler's ability to collect multiple samples with consistent physical or chemical

characteristics, or both, from a homogenous layer of sediment

- P4. Evaluate whether the sampler can collect a representative sample from a "clean" sediment layer that is below a contaminated sediment layer
- P5. Assess the sampler's ability to be adequately decontaminated between sampling areas
- P6. Measure the time required for each activity associated with sample collection (sampler setup, sample collection, sampler disassembly, and sampler decontamination)
- P7. Estimate costs associated with sample collection activities (sampler, labor, supply, IDW disposal, and support equipment costs)

The secondary objectives for the innovative sediment sampler demonstration were as follows:

- S1. Document the skills and training required to properly operate the sampler
- S2. Evaluate the sampler's ability to collect samples under a variety of site conditions
- S3. Assess the sampler's ability to collect an undisturbed sample
- S4. Evaluate the sampler's durability based on its materials of construction and engineering design
- S5. Document the availability of the sampler and spare parts

The objectives for the demonstration were developed based on input from MMT Program members, general user expectations of sediment sampler capabilities, characteristics of the demonstration areas, the time available to complete the demonstration, and sampler capabilities that ARI intended to highlight.

## 4.2 Demonstration Design

In February 1999, a predemonstration sampling and analysis investigation was conducted to assess existing conditions and confirm available information on physical and chemical characteristics in each demonstration area. Based on information from the predemonstration investigation as well as available historical data, a demonstration design was developed to address the demonstration objectives. Input regarding the demonstration design was obtained from demonstration site representatives and ARI. Table 4-1 summarizes the demonstration design.

ARI operated the Russian Peat Borer in each demonstration area. The EPA made observations and took measurements to evaluate the Russian Peat Borer in accordance with the demonstration objectives. In addition, a reference sampler was selected for each demonstration area either because the sampler had been successfully used to collect sediment samples in the particular demonstration area or because it is typically used to collect sediment samples under the conditions encountered in the particular area. The Vibrocorer was used as the reference sampler in S1A1. The Hand Corer was used as the reference sampler in S1A2, S2A1, and S2A2. Similarly, the sampling platforms used were selected based on their availability but not necessarily based on sampler requirements. For example, in S1A1, the EPA GLNPO's *Mudpuppy* was used because it was available free of charge from EPA Region 5. During the demonstration, each reference sampler was evaluated under the same conditions and objectives as the Russian Peat Borer. All the sampling activities conducted by ARI for the Russian Peat Borer were also conducted by the sampling technicians for the reference samplers (for example, the EPA GLNPO operated the Vibrocorer). During the use of each reference sampler, the EPA also took the same measurements and made the same observations as were performed for the Russian Peat

Borer. The reference sampler for Site 2 was not designed to collect core samples from the 9- to 11-foot bss sampling depth interval. Therefore, in this sampling depth interval, the reference sampler was not used.

The approach used to address each primary objective for the innovative and reference core samplers is discussed below. Because of varying sampler features, the characteristics of the demonstration areas, and the limited time available for the field demonstration, not all primary objectives were addressed in each demonstration area. However, the Russian Peat Borer and a reference sampler were evaluated under three or more primary objectives in each demonstration area.

- To address primary objective P1, a volume of sediment to be collected was specified for each sampling depth interval. The volume specified was based on analytical requirements for characterizing the sample or on the design volume of the sampler for the particular sampling depth interval. If after one attempt the sampler had not retrieved the specified volume of sediment, additional attempts were made to retrieve the specified volume. The number of attempts required and the volume of sediment collected in each attempt at a given location within an area were noted.
- Primary objective P2 was addressed by verifying that each sediment sampler was able to consistently sample a specified depth interval. For each sampler, the depth of sampler deployment, total sample length, and sample length within the specified depth interval were noted. Various site conditions, including sediment depth, water depth, and sediment composition, were considered in addressing P2 in each demonstration area.
- Primary objective P3 was addressed by analyzing samples collected in a homogenous sediment layer for arsenic or PSD. P3 was addressed in the deeper sampling depth interval in S1A2 and in both sampling depth intervals in S2A1. These areas and intervals were chosen for this purpose because, according to the analytical results for predemonstration investigation samples, these intervals exhibited relatively consistent chemical or physical characteristics or both.



**Table 4-1. Innovative Sediment Sampler Demonstration Design**

Demonstration Area	Target Sampling Depth Interval (bss)	Primary Objective	Sampling Parameter (Matrix)	Volume Required per Sample	Sampler
S1A1 (river mouth)	0 to 4 inches	P1 Volume P2 Depth interval P6 Sample collection time	Core length and volume (sediment)	Design volume <sup>a</sup>	Russian Peat Borer Vibrocorer
	6 to 12 inches	P1 Volume P2 Depth interval P5 Decontamination P6 Sample collection time P7 Cost	PCBs, volume, and core length (sediment)	250 mL	Russian Peat Borer Vibrocorer
			PCBs (final rinsate)	1 L	
4 to 6 feet	P1 Volume P2 Depth interval P6 Sample collection time	Core length and volume (sediment)	Design volume	Russian Peat Borer Vibrocorer	
S1A2 (freshwater bay)	0 to 4 inches	P1 Volume P2 Depth interval P6 Sample collection time	Core length and volume (sediment)	Design volume	Russian Peat Borer Hand Corer
	12 to 32 inches	P1 Volume P2 Depth interval P3 Consistent samples from a homogenous layer P6 Sample collection time	PSD, volume, and core length (sediment)	250 mL	Russian Peat Borer Hand Corer
S2A1 (lake)	0 to 4 inches	P1 Volume P2 Depth interval P3 Consistent samples from a homogenous layer P4 Clean layer below contaminated layer P5 Decontamination P6 Sample collection time P7 Cost	Arsenic, PSD, volume, and core length (sediment)	250 mL	Russian Peat Borer Hand Corer
			Arsenic (final rinsate)	500 mL	
	10 to 30 inches	P1 Volume P2 Depth interval P3 Consistent samples from a homogenous layer P4 Clean layer below contaminated layer P6 Sample collection time	Arsenic, PSD, volume, and core length (sediment)	250 mL	Russian Peat Borer Hand Corer
S2A2 (wetland)	4 to 12 inches	P1 Volume P2 Depth interval P6 Sample collection time	Core length and volume (sediment)	Design volume	Russian Peat Borer Hand Corer
	9 to 11 feet	P1 Volume P2 Depth interval P6 Sample collection time	Core length and volume (sediment)	Design volume	Russian Peat Borer

Notes:

- bss = Below sediment surface
- L = Liter
- mL = Milliliter
- PCB = Polychlorinated biphenyl
- PSD = Particle size distribution

<sup>a</sup> For a given depth interval, the design volume corresponds to 100 percent sample recovery.

- Primary objective P4 was addressed by evaluating whether a sample could be collected from a layer of sediment with relatively low contaminant concentrations (a “clean” layer) beneath a “contaminated” layer of sediment that had significantly higher contaminant concentrations without cross-contaminating the clean layer sample. P4 was addressed in S2A1 because, according to the results of the predemonstration investigation, a clean layer of sediment was present beneath a relatively contaminated layer of sediment. During the demonstration, sediment samples were collected from each layer and analyzed for arsenic. The analytical data for these samples were used to determine whether sediment from the contaminated layer had been carried into the clean layer during sampler deployment and retrieval.
  - Primary objective P5 was addressed by collecting samples of equipment rinsate (water) during the final stage of core sampler decontamination. P5 was addressed in the deeper sampling depth interval in S1A1 and in the shallower sampling depth interval in S2A1 because sediment in these areas and intervals contained the highest observed concentrations of PCBs and arsenic, respectively, among the demonstration areas. Decontamination of each sampler demonstrated in a given area was performed after all samples had been collected in that area.
  - Primary objective P6 was addressed by measuring the time required for each activity associated with sample collection, including sampler setup, sample collection, sampler disassembly, and sampler decontamination. P6 was addressed in all demonstration areas to satisfy this objective under a variety of site conditions.
  - Primary objective P7 was addressed in S1A1 and S1A2 by estimating the costs associated with sample collection activities, including sampler, labor, IDW disposal, and support equipment costs. The following costs associated with collection of all the investigative samples in each area where P7 was addressed were accounted for:
    1. The sampler cost was estimated based on price lists for purchasing each sediment sampler; disposable, plastic core liners (if applicable); and support equipment. Leasing costs for the samplers were not considered because the samplers are unavailable for leasing.
    2. The labor cost was estimated based on the number of people required to operate each sediment sampler and the time required to conduct sampling activities (sampler setup, sample collection, sampler disassembly, and sampler decontamination).
    3. The IDW disposal cost was estimated for specified areas. A volume of sediment to be collected was specified for each demonstration area where P7 was addressed. For each such area, any sediment collected by a sampler that was not required for analytical purposes was considered to be IDW. For example, the sediment collected above and below the specified depth interval and the portion of a sample exceeding the specified volume within a given depth interval were considered to be IDW.
    4. The support equipment cost was estimated based on the rental or purchase cost of any additional equipment required for sample collection, such as generators or winches needed at the time of the demonstration.
- Secondary objectives S1, S2, and S3 were addressed in all the demonstration areas where a given sampler was evaluated because no additional sampling was required to address them. Secondary objectives S4 and S5 were not area-dependent; they were addressed based on developer information as well as observations of sampler performance during the demonstration. The approach used to address each secondary objective is discussed below.
- Secondary objective S1 was addressed by observing and noting the skills required to operate each sampler during the demonstration, how easy the sampler was to operate, and the sampler’s approximate weight and by discussing any necessary sampling technician training with the developer.
  - Secondary objective S2 was addressed by determining each sampler’s ability to collect sediment samples given the variety of sampling platforms, water depths,

sediment depths, sediment compositions, and flow conditions encountered in the demonstration areas.

- Secondary objective S3 was addressed based on visual observations made during sampling or after a sediment sample had been extruded from a sampler.
- Secondary objective S4 was addressed by noting each sampler's materials of construction. Sediment sampler failures or repairs that were necessary during use of the sampler were also noted.
- Secondary objective S5 was addressed by discussing the availability of replacement samplers with the developer and determining whether spare parts were available in a retail store or only through the developer. In addition, when replacement samplers or spare parts were required during the demonstration, their availability was noted.

### 4.3 Field Sampling and Measurement Procedures

This section presents field sampling and measurement procedures used during the Russian Peat Borer demonstration. Specifically, this section summarizes demonstration sampling locations; sample collection, sample preparation, and measurement procedures; and field QC procedures. Additional details about the sample collection, sample preparation, and measurement procedures are presented in the demonstration plan (EPA 1999). The demonstration plan is available on the Internet through the ORD web site (<http://www.epa.gov/ORD/SITE>).

Sediment samples were collected at Site 1 for PCB analysis, at Site 2 for arsenic analysis, and at both sites for PSD analysis. The sampling locations in each demonstration area are presented in Figures 4-1 and 4-2. Table 4-2 lists the target sampling depth intervals, numbers of investigative samples, and analytical parameters for each demonstration area and provides the rationale for their selection. In general, the rationale for choosing the number of samples to be collected in each area was based on the objectives to be addressed, the analyses to be conducted to address one or more objectives, the time required to collect samples, and the cost of each analysis. When five samples were to be collected in a sampling area, samples were collected in the

four corners and center of the area; when ten samples were collected in a sampling area, the additional five samples were collected at locations randomly distributed throughout the area.

Many of the field measurements made to support the primary objectives (see Section 4.2) were simple, standard measurements and do not require additional explanation. These measurements include the volume of IDW generated, number of sampling technicians, number of sampling attempts per location, volume of sediment collected, time required for sample collection activities, volume of fuel consumed to operate motorized sampling or support equipment, core length, sampling area grid size, and water velocity. However, several field measurements were made to address demonstration-specific requirements, and additional explanation of these measurements is warranted to enhance understanding of the sampler performance results presented in Chapters 6 and 7. These field measurements are summarized below by objective.

- To address primary objective P1, the volume of sediment sample from a given depth interval was measured, and then any unrepresentative material was removed from the sediment sample and collected as IDW. Unrepresentative material included sticks, shells, and stones. After removal of unrepresentative material, if not enough sediment was left to meet analytical sample volume requirements, the sampling technician collected additional cores from the sampling location.
- To address primary objective P2, the depth of sampler deployment was measured by allowing the sampling technician to lower the sampler to the surface of the sediment. Once the sampling technician felt that he had identified the sediment surface, a mark was made on the sampler cable or extension rod using a fixed reference point (the water surface, boat side, or boat floor). Another mark was made higher on the cable or extension rod indicating the depth corresponding to the sampling technician's estimate of the depth to which the sampler should be driven to collect a sediment sample from the specified sampling depth interval. The sampler was then lowered to this depth, and a sample was collected. For measurement of the total core length retrieved and the core length retrieved in the sampling depth interval, no correction



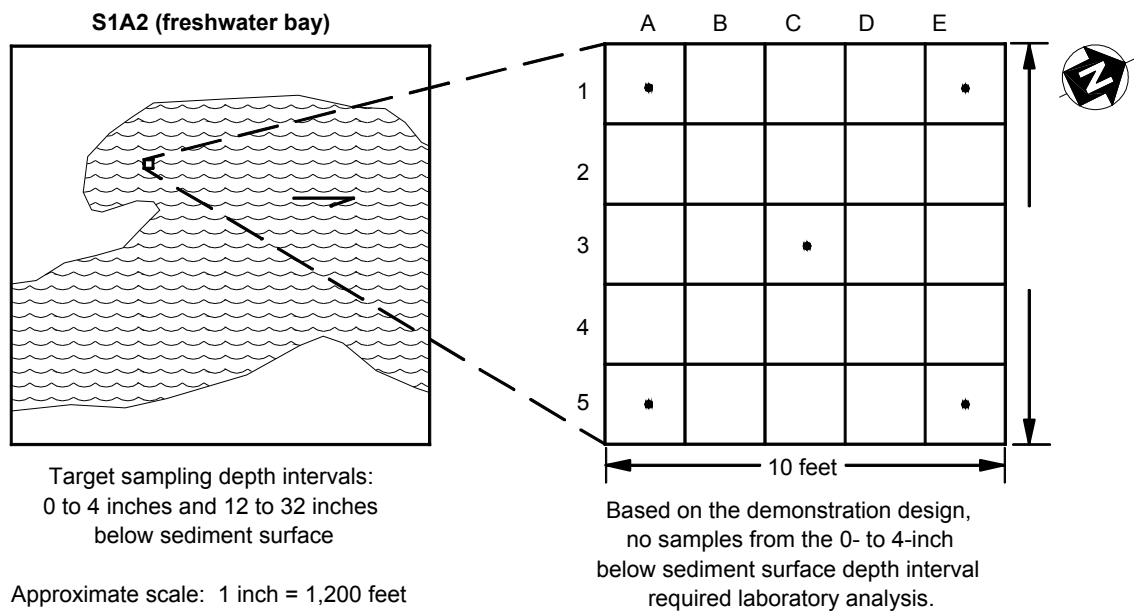
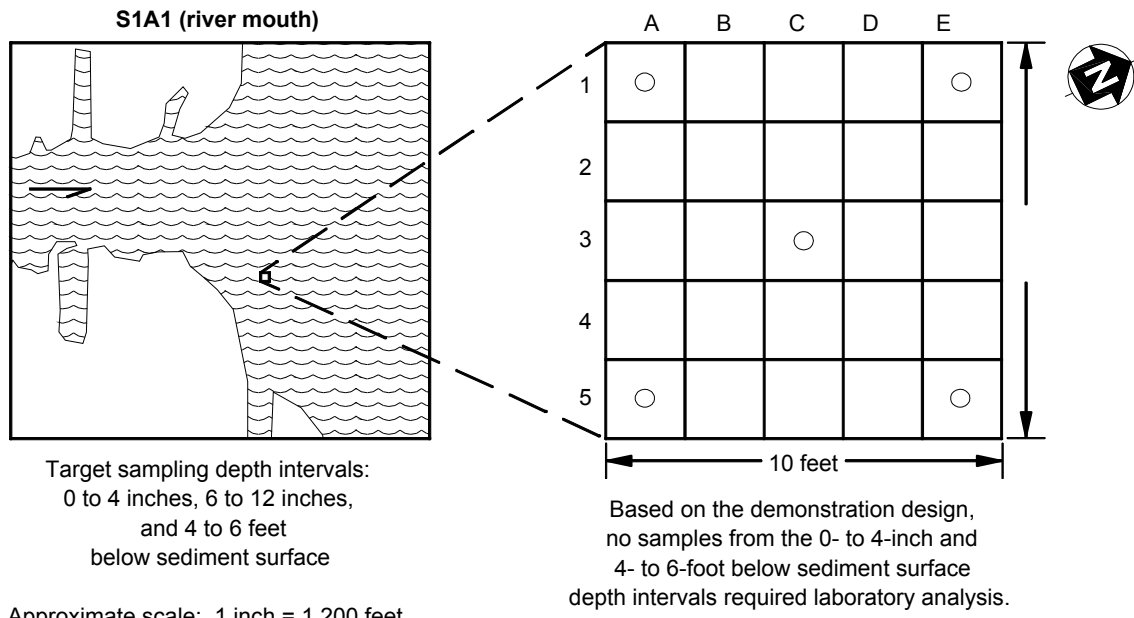

Legend	
○	Polychlorinated biphenyls
●	Particle size distribution
→	Flow direction

Figure 4-1. Site 1 sampling locations.

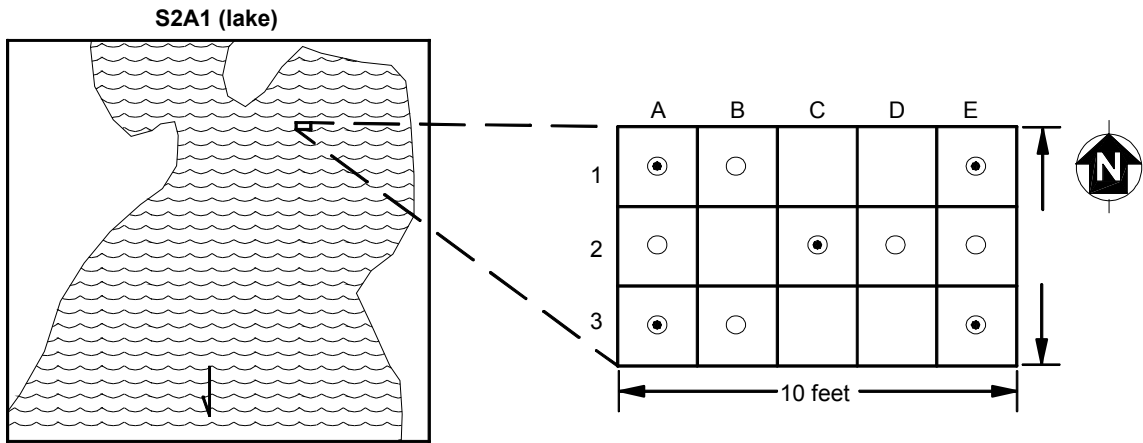

Target sampling depth intervals:  
0 to 4 inches and 10 to 30 inches  
below sediment surface

Approximate scale: 1 inch = 1,200 feet

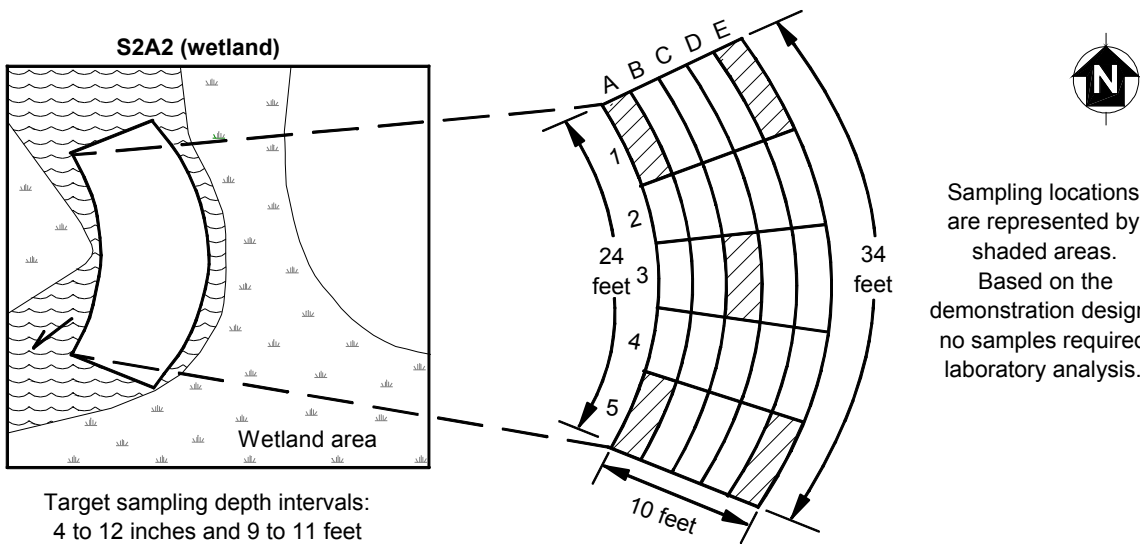

Target sampling depth intervals:  
4 to 12 inches and 9 to 11 feet  
below sediment surface

Approximate scale: 1 inch = 20 feet

Sampling locations  
are represented by  
shaded areas.  
Based on the  
demonstration design,  
no samples required  
laboratory analysis.

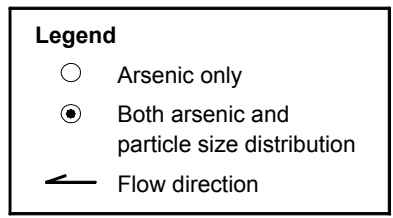

Figure 4-2. Site 2 sampling locations.

**Table 4-2. Rationale for Sampling Approach**

Demonstration Area	Target Sampling Depth Interval (bss)	Number of Investigative Samples per Sampler <sup>a</sup> (Analytical Parameter)	Matrix	Rationale
S1A1 (river mouth)	0 to 4 inches	5 (NA)	Sediment	Analytical samples not collected because only primary objectives P1 (volume), P2 (depth interval), and P6 (sample collection time) were addressed
	6 to 12 inches	5 (PCBs)	Sediment	Verify that contamination was present
		1 (PCBs)	Equipment rinsate	Determine whether a sampler could be adequately decontaminated (primary objective P5)
	4 to 6 feet	5 (NA)	Sediment	Analytical samples not collected because only primary objectives P1 (volume), P2 (depth interval), and P6 (sample collection time) were addressed
S1A2 (freshwater bay)	0 to 4 inches	5 (NA)	Sediment	Analytical samples not collected because only primary objectives P1 (volume), P2 (depth interval), and P6 (sample collection time) were addressed
	12 to 32 inches	5 (PSD)	Sediment	Determine whether a sampler could collect consistent samples from a homogenous layer of sediment (primary objective P3) with consistent physical characteristics
S2A1 (lake)	0 to 4 inches	10 (Arsenic) 5 (PSD)	Sediment	Determine whether a sampler could collect consistent samples from a homogenous layer of sediment (primary objective P3) with consistent physical and chemical characteristics and determine whether a sampler could collect sediment samples from a clean layer of sediment located below a layer of contaminated sediment (primary objective P4)
		1 (Arsenic)	Equipment rinsate	Determine whether a sampler could be adequately decontaminated (primary objective P5)
	10 to 30 inches	10 (Arsenic) 5 (PSD)	Sediment	Determine whether a sampler could collect consistent samples from a homogenous layer of sediment (primary objective P3) with consistent physical and chemical characteristics and determine whether a sampler could collect sediment samples from a clean layer of sediment located below a layer of contaminated sediment (primary objective P4)
S2A2 (wetland)	4 to 12 inches	5 (NA)	Sediment	Analytical samples not collected because only primary objectives P1 (volume), P2 (depth interval), and P6 (sample collection time) were addressed
	9 to 11 feet	5 (NA)	Sediment	

Notes:

- bss = Below sediment surface
- NA = Not applicable
- PCB = Polychlorinated biphenyl
- PSD = Particle size distribution

<sup>a</sup> The number of investigative samples varied depending on the analytical parameters and the objectives addressed in each demonstration area. Ten investigative samples were collected and analyzed for arsenic to address primary objectives P3 and P4. However, only five investigative samples were collected and analyzed for PSD to address primary objective P3 because the variability associated with PSD is typically less than that associated with arsenic concentrations.

- was made for sample compression or expansion that might have taken place during sample collection.
- To address primary objectives P3 and P4, excess water overlying the sediment samples was carefully decanted before the samples were transferred to stainless-steel bowls and homogenized. The decanting step ensured that the sediment samples would have adequate percent solids for analysis. Homogenization involved stirring the material with a stainless-steel spoon for 4 minutes or longer until the sediment attained uniform color, texture, and residual

water distribution. Sample containers were then filled using a quartering technique in which the homogenized sample present in the stainless-steel bowl was divided into quadrants. Each sample container was filled by using a spoon to alternately transfer sediment from one quadrant and then from the opposite quadrant until the sample container was filled. Any unused sediment was collected as IDW.

- To address primary objective P5, the nondisposable components of each sampler were decontaminated by scrubbing them with an Alconox solution, washing them with potable water, and then rinsing them with deionized water. At Site 1, 3 L of rinsate per sampler was generated to meet analytical and QC volume requirements for PCB analysis. At Site 2, 2 L of rinsate per sampler was generated to meet analytical and QC volume requirements for arsenic analysis. All deionized water used to generate rinsate samples was from one lot of water identified by a lot number. To verify that any contamination detected by the laboratory in the rinsate samples was not present in the deionized water or the result of field sample collection procedures at Sites 1 and 2, samples of this water were sent to the laboratory for PCB and arsenic analyses, respectively, along with the rinsate samples. Deionized water samples were collected once at each demonstration site during collection of sediment samples.
- To address primary objective P6, timing of sampler setup began when a sampling technician began assembling a given sampler and ended when the sampler was completely assembled and any additional equipment necessary for sampling using the sampler had been collected and was ready to be transported to the sampling location. If additional time was required to set up the sampler at the sampling location, this time was measured and included in the total setup time.

Timing of sample collection began when the sampler was ready to be deployed and ended when the sample had been retrieved; extruded from the sampler; and submitted for measurement, preparation, and distribution into the appropriate containers for analysis. If additional sampling attempts were required to collect the specified sample volume, the time required to complete these attempts was added to

the sample collection time. If any portion of the sampler was disassembled to extrude a sample and reassembled before the next sample was collected, the time required for disassembly and reassembly was included in the total sample collection time. Between sampling attempts and locations, if a sampler had any sediment adhering to it, the sampler was rinsed at the sampling location using surface water. The time required for rinsing was also added to the total sample collection time. Sample collection time did not include the time needed to position the sampling platforms at specific sampling locations.

Timing of sampler disassembly began when all samples had been collected or extruded and the sampling technician began disassembly of the sampler. The timing ended when the sampler had been completely disassembled and was ready to be decontaminated.

Timing of sampler decontamination began when the nondisposable components of each sampler were decontaminated by scrubbing them with an Alconox solution. The timing continued until the sampling technician considered the sampler to be decontaminated to the degree that a sample of the final rinsate could be collected to address primary objective P5. Sampler decontamination occurred once in each demonstration area after all samples were collected and the sampler was disassembled.

QC checks for field measurements were used to evaluate the quality of field activities. In general, the QC checks were used to assess the representativeness of the samples and to ensure that the degree to which the analytical data were representative of actual site conditions was known and documented. QC checks for field parameters consisted of the time required for sample collection activities and the water velocity. Field QC checks for laboratory parameters consisted of temperature blanks (in shipments that contained samples for PCB analysis) and field replicates. Field replicates were collected to evaluate whether a sample was adequately homogenized in the field prior to filling of sample containers. Field replicate samples included field duplicates (rinsate) for PCB and arsenic analyses and field triplicates (sediment) for PCB, arsenic, and PSD analyses. Table 4-3 identifies the planned numbers of investigative samples and field replicate samples. Field replicate samples were submitted

**Table 4-3. Sample Matrix**

Demonstration Area	Target Sampling Depth Interval (bss)	Sampler	Analytical Parameter	Sediment Samples					Equipment Rinsate Samples			
				Number Per Sampler				Total Number of Analyses	Number Per Sampler			Total Number of Analyses
				Investigative Samples	MS/MSD Samples <sup>a</sup>	Field Triplicate Samples <sup>b</sup>	Laboratory Analyses		Equipment Rinsate Samples	Field Duplicate Samples <sup>c</sup>	Laboratory Analyses	
S1A1 (river mouth)	0 to 4 inches	Russian Peat Borer Vibrocorer	NA	5	Samples were not analyzed for PCBs, arsenic, or PSD. The rationale for the number of samples is provided in Table 4-2.							
	6 to 12 inches	Russian Peat Borer Vibrocorer	PCBs	5	1	2	11	22	1	1	2	4
	4 to 6 feet	Russian Peat Borer Vibrocorer	NA	5	Samples were not analyzed for PCBs, arsenic, or PSD. The rationale for the number of samples is provided in Table 4-2.							
S1A2 (freshwater bay)	0 to 4 inches	Russian Peat Borer Hand Corer	NA	5	Samples were not analyzed for PCBs, arsenic, or PSD. The rationale for the number of samples is provided in Table 4-2.							
	12 to 32 inches	Russian Peat Borer Hand Corer	PSD	5	NA	1	7	14	NA	NA	0	0
S2A1 (lake)	0 to 4 inches	Russian Peat Borer Hand Corer	Arsenic	10	2	3	20	40	1	1	2	4
			PSD	5	NA	1	7	14	NA	NA	0	0
	10 to 30 inches	Russian Peat Borer Hand Corer	Arsenic	10	2	3	20	40	0	0	0	0
			PSD	5	NA	1	7	14	NA	NA	0	0
S2A2 (wetland)	4 to 12 inches	Russian Peat Borer Hand Corer	NA	5	Samples were not analyzed for PCBs, arsenic, or PSD. The rationale for the number of samples is provided in Table 4-2.							
	9 to 11 feet	Russian Peat Borer	NA	5	Samples were not analyzed for PCBs, arsenic, or PSD. The rationale for the number of samples is provided in Table 4-2.							

Notes:

bss = Below sediment surface      NA = Not applicable      PSD = Particle size distribution  
 MS/MSD = Matrix spike/matrix spike duplicate      PCB = Polychlorinated biphenyl

- <sup>a</sup> MS/MSD samples were collected for PCB and arsenic analyses and were designated in the field. MS/MSD samples were not collected for equipment rinsate samples because the additional volume required for the analysis may have diluted any contamination present to concentrations below laboratory detection limits. Sediment MS/MSD samples did not require additional sample volume.
- <sup>b</sup> Field triplicate sediment samples were collected by filling three sample containers with homogenized sediment. A sufficient volume of sediment for field triplicate samples was collected as described in the approach for addressing primary objective P1 in Section 4.2. Field triplicate samples were submitted for analysis as blind samples.
- <sup>c</sup> Field duplicate equipment rinsate samples were collected by filling one additional container for PCB or arsenic analysis. Field duplicate samples were submitted for analysis as blind samples.

for laboratory analysis as blind samples (that is, the laboratories did not know which samples were replicates). Acceptance criteria and associated corrective actions for field QC checks are presented in the demonstration plan (EPA 1999).

During the demonstration, the EPA conducted an internal technical system audit (TSA) of field sampling and measurement systems. The following activities were audited during the field TSA: sample collection; sample preparation; field measurements; field documentation; decontamination; and sample labeling, packaging, and shipping.

A summary discussion of whether the field QC procedures generated data that met the demonstration objectives is presented in Sections 6.3 and 7.3 for the innovative and reference samplers, respectively. More detailed information is provided in the DER (Tetra Tech EM Inc. [Tetra Tech] 1999c).

#### **4.4 Laboratory Sample Preparation and Analysis Methods**

In selecting appropriate methods for preparing and analyzing the demonstration samples from Sites 1 and 2, the specific analytes of interest, the laboratories' experience in analyzing the predemonstration samples, and the target reporting limits required to address the demonstration objectives were taken into account. Table 4-4 summarizes the laboratory sample preparation and analysis methods used for the demonstration.

Laboratory QC checks were used to demonstrate the absence of interferants and contamination from laboratory glassware and reagents, to verify that the measurement systems were in control, to evaluate the precision and

accuracy of laboratory analyses, and to ensure the comparability of data. Laboratory-based QC checks other than those associated with instrument calibration consisted of method blanks, surrogates, MS/MSDs, extract and digestate duplicates, blank spike/blank spike duplicates (BS/BSD), interference check analyses, serial dilutions, postdigestion spikes, repeat analyses, and performance evaluation (PE) samples. Table 4-5 summarizes the laboratory QC checks used for the demonstration and their purpose. The frequencies, acceptance criteria, and corrective actions for QC checks are presented in the demonstration plan (EPA 1999).

Predemonstration and in-process TSAs of the laboratories used for the demonstration were conducted. The following activities were audited: sample receipt and sample storage; internal chain of custody; sample extraction, digestion, and cleanup; sample analysis; standards preparation and storage; calibration; QC procedures; and data reduction, validation, and reporting.

Predemonstration and in-process performance audits of laboratory activities were also conducted for PCB and arsenic analyses. During each audit, (1) two PE samples (one low-level and one high-level) each for PCBs and arsenic were obtained for the sediment matrix and (2) one low-level PE sample each for PCBs and arsenic was obtained for the aqueous matrix. The PE samples were submitted to the laboratory as double-blind samples for analysis.

A summary discussion of whether the laboratory QC procedures generated data that met the demonstration objectives is presented in Sections 6.3 and 7.3 for the innovative and reference samplers, respectively. More detailed information is provided in the DER (Tetra Tech 1999c).

**Table 4-4. Laboratory Sample Preparation and Analysis Methods**

Parameter (Matrix)	Method Reference <sup>a</sup>	Method Title
PCBs (sediment)	SW-846 Method 3550B (extraction)	Ultrasonic Extraction
	SW-846 Method 3665A <sup>b</sup> (cleanup)	Sulfuric Acid/Permanganate Cleanup
	SW-846 Method 3660B <sup>c</sup> (cleanup)	Sulfur Cleanup
	SW-846 Method 8082 (analysis)	PCBs by Gas Chromatography
PCBs (equipment rinsate)	SW-846 Method 3510C (extraction)	Separatory Funnel Liquid Extraction
	SW-846 Method 3665A <sup>b</sup> (cleanup)	Sulfuric Acid/Permanganate Cleanup
	SW-846 Method 8082 (analysis)	PCBs by Gas Chromatography
Arsenic (sediment)	SW-846 Method 3050B (digestion)	Acid Digestion of Sediment, Sludges, and Soils
	SW-846 Method 6010B (analysis)	Inductively Coupled Plasma-Atomic Emission Spectrometry
Arsenic (equipment rinsate)	SW-846 Method 3010A (extraction)	Acid Digestion of Aqueous Samples and Extracts for Total Metals for Analysis by FLAA or ICP Spectroscopy
	SW-846 Method 6010B (analysis)	Inductively Coupled Plasma-Atomic Emission Spectrometry
PSD (sediment)	ASTM Method D 422-63 (Reapproved in 1990)	Standard Method for Particle-Size Analysis of Soils (with hydrometer option)

Notes:

- ASTM = American Society for Testing and Materials
- EPA = U.S. Environmental Protection Agency
- FLAA = Flame atomic absorption
- ICP = Inductively coupled argon plasma
- PCB = Polychlorinated biphenyl
- PSD = Particle size distribution

<sup>a</sup> SW-846 reference: EPA 1996; ASTM reference: ASTM 1998

<sup>b</sup> SW-846 Method 3665A is used whenever elevated baselines or overly complex chromatograms prevent accurate quantitation of Aroclors. The laboratory routinely performed sulfuric acid cleanup on PCB sample extracts using SW-846 Method 3665A.

<sup>c</sup> The laboratory detected elevated levels of sulfur in predemonstration investigation samples analyzed for PCBs. Therefore, the laboratory monitored PCB chromatograms for the presence of sulfur and cleaned up the extracts using SW-846 Method 3660B when sulfur was detected.



**Table 4-5. Laboratory Quality Control Checks**

Quality Control Check	Parameter	Matrix	Purpose
Method blanks	PCBs and arsenic	Sediment and rinsate	Verify that steps in the analytical procedures did not introduce contaminants that affected analytical results
Surrogates	PCBs	Sediment and rinsate	Determine whether significant matrix effects existed within the samples and measure the efficiency of recovery of analytes in sample preparation and analysis
MS/MSDs <sup>a</sup>	PCBs and arsenic	Sediment	Determine the accuracy and precision of the analytical results with respect to the effects of the sample matrix
Extract duplicates	PCBs	Sediment and rinsate	Determine the precision associated with laboratory analytical procedures following sample extraction
Digestate duplicates	Arsenic	Sediment and rinsate	Determine the precision associated with laboratory analytical procedures following sample digestion
BS/BSDs	PCBs and arsenic	Sediment and rinsate	Determine whether observed deviations for MS/MSDs and for extract and digestate duplicate samples were caused by a matrix effect
Interference check analyses	Arsenic	Sediment and rinsate	Evaluate the validity of the interelement correction factors
Serial dilutions	Arsenic	Sediment and rinsate	Determine whether significant physical or chemical interferences existed as a result of the sample matrix
Postdigestion spikes	Arsenic	Sediment and rinsate	Determine whether a matrix effect should be expected
Repeat analyses	PSD	Sediment	Evaluate the precision of hydrometer readings
PE samples	PCBs and arsenic	Sediment and water	Determine the accuracy associated with the laboratory analytical procedures for low-level and high-level concentrations

Notes:

- BS/BSD = Blank spike/blank spike duplicate
- MS/MSD = Matrix spike/matrix spike duplicate
- PCB = Polychlorinated biphenyl
- PE = Performance evaluation
- PSD = Particle size distribution

<sup>a</sup> MS/MSD samples were not collected for equipment rinsate samples because the additional volume required for the analysis may have diluted any contamination present to concentrations below laboratory detection limits. In addition, MS/MSDs are not typically collected for rinsate samples.

---

## Chapter 5

### Description of the Reference Sediment Samplers

This chapter describes two conventional sediment samplers that were used as reference samplers during the demonstration. Each reference sampler was chosen based on its proven ability to meet the various demonstration objectives presented in Section 4.1. Specifically, two core samplers were selected as reference samplers: the Hand Corer and the Vibrocorer.

The Hand Corer is a commonly used core sampler designed to obtain sediment samples in a variety of lake and river environments. The sampler can collect continuous sediment cores to a depth of about 36 inches bss. Based on the predemonstration investigation results, demonstration objectives, and site support facilities available, the Hand Corer was selected as the reference sampler for S1A2, S2A1, and S2A2.

The Vibrocorer is a core sampler designed to obtain sediment samples in a variety of shallow and deep river, lake, and ocean environments. The sampler has been successfully used by the EPA at several contaminated sites in Region 5. Based on the predemonstration investigation results, demonstration objectives, and site support facilities available, the Vibrocorer was selected as the reference sampler for S1A1.

Sections 5.1 and 5.2 provide descriptions, discuss general operating procedures, and outline advantages and limitations of the Hand Corer and Vibrocorer used in the demonstration.

#### 5.1 Hand Corer

The Hand Corer selected as a reference sampler for the demonstration is designed to collect undisturbed, cylindrical core samples from various types of sediment,

including saturated sands and silts, to a depth of about 36 inches bss in stagnant or swiftly moving water.

##### 5.1.1 Technology Description

Components of the Hand Corer include (1) a Lexan™ nose piece; (2) a 36-inch-long, stainless-steel core tube; (3) a stainless-steel head piece with a flutter valve; (4) two detachable, stainless-steel handles; and (5) a clevis (see Figure 5-1). For deployment in deep water, the Hand Corer can be equipped with a guide rope or extension rods and a turning handle. The Hand Corer can also be equipped with disposable, clear plastic core tube liners that fit inside the core tube (these liners are not shown in Figure 5-1).

Support equipment for sampler deployment may include a tripod-mounted winch for (1) controlling the rate of sampler deployment and retrieval; (2) minimizing the physical stress on the sampling technician, particularly during sampler retrieval and during intense or extended sampling events; and (3) preventing the sampler from sinking too deeply into the sediment to obtain a representative sample.

The stainless-steel core tube has a 2-inch outside diameter and is designed to collect about 50 mL of sediment per inch of core tube length; the maximum design volume of the core tube is about 1,800 mL. The fully equipped Hand Corer, including the nose piece, core tube, head piece with flutter valve, handles, and clevis, weighs about 12 lb. Each 5-foot-long extension rod and a turning handle weigh about 5 and 2 lb, respectively.

In water less than 20 feet deep, the Hand Corer may be manually deployed and driven into the sediment using the

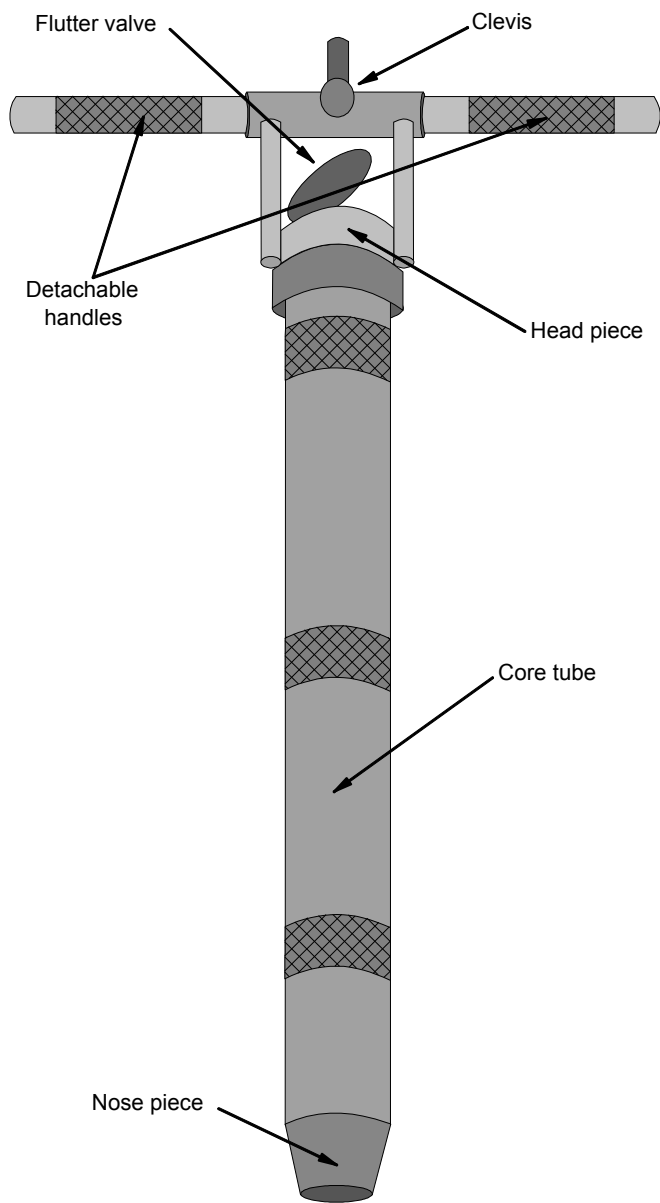

Figure 5-1. Hand Corer.

handles and the necessary length of extension rods. In water more than 20 feet deep, the sampler may be deployed using a guide rope attached to the clevis and a weight attached to the core tube. During sampler retrieval, a sediment core is retained in the core tube by a partial vacuum created by the closed flutter valve.

### 5.1.2 General Operating Procedures

The Hand Corer can be operated in shallow water by one person from a platform, from a boat, or while wading. For

sampling in deep water, two sampling technicians are recommended to control the weight of the sampler and extension rods and to conduct efficient sampling. During sampler assembly, a plastic core tube liner may be inserted into the core tube. Core tube liners hold and store the sample for later examination. Depending on the water depth and flow conditions, either the handles and the necessary number of extension rods or the guide rope can be used to deploy the Hand Corer to the sediment surface. The speed of sampler deployment to the sediment surface should be controlled to avoid bow wave formation, which could disturb flocculent or unconsolidated sediment that might be near the sediment surface (Blomqvist 1991).

The sampler may be driven into the sediment by manual force on the handles or by gravity penetration. In general, the sampler should be driven into the sediment in a steady and uninterrupted manner. The sampler is manually retrieved by pulling upward on the handles, extension rods, or guide rope, as appropriate. When samples are being collected in shallow water depths, the flutter valve should be manually closed once the Hand Corer reaches the desired sediment depth. When the sampler is being retrieved from deep water depths, the upward motion of the submerged sampler causes the flutter valve to automatically close. The tapered nose piece and partial vacuum created by the flutter valve retain the sediment core in the plastic core tube liner. When the weight of the sampler and extension rods requires it, a tripod-mounted winch should be used to control the rate of sampler retrieval. The sampler should be kept vertical and the rate of retrieval should be kept as steady as possible to minimize resuspension and disruption of the sediment.

After sampler retrieval, the nose piece or head piece is removed to allow removal of the plastic core tube liner. The sediment core enclosed in the core tube liner may be either sealed in the core tube using two core caps or extruded for further examination and processing. The sediment core may be removed by pushing the sample out one end of the core tube liner with an extrusion rod. Prior to sampling, some sampling technicians cut the core tube liner twice longitudinally and tape the liner together with vinyl electrical tape before inserting the liner into the core tube. In this case, after a sample is collected, the tape holding the two halves of the core tube liner is cut, splitting the liner in half and exposing the sediment core.

### 5.1.3 *Advantages and Limitations*

An advantage of the Hand Corer is that it is easy to operate, requiring minimal skills and training. Sampler assembly and sample collection procedures can be learned in the field with a few practice attempts. In addition, a written SOP typically accompanies the sampler when it is procured. The sampler can be operated by one person in shallow (wading) water depths because of its light weight (12 lb). Sampler operation is especially simple when a core tube liner is used because the sampler does not require complete disassembly to extrude the sample and reassembly after each sampling attempt. Only the nose piece or head piece requires detachment to remove the plastic core tube liner containing the sediment core. Use of the disposable liner also minimizes the risk of cross-contamination between sampling locations.

Another advantage of the Hand Corer is the flutter valve in the head piece. The flutter valve is designed to allow water to exit the top of the core tube during sampler deployment, thus minimizing potential bow wave formation near the sediment surface. During sampler retrieval, the sediment core is retained in the core tube by a partial vacuum created by the closed flutter valve. Collectively, these design features increase the likelihood of collecting an undisturbed sample.

A limitation of the Hand Corer is that during sampler deployment, the plastic core tube liner is exposed to different layers of sediment contamination. Contaminants may adhere to the exposed surface of the liner while the sampler passes through different layers of sediment. Also, the flutter valve may become clogged if the sampler is deployed in such a way that the flutter valve is driven into the sediment. Specifically, sediment and nonsedimentaceous materials (leaves, plant roots, or small stones) may become trapped between the flutter valve and core tube, resulting in partial or complete loss of vacuum and eventually partial or complete loss of the sediment sample.

Another limitation of the Hand Corer is that it cannot collect discrete samples from various sediment depths. Core samples must be collected from the sediment surface downward. Because end-filling samplers such as the Hand Corer must collect samples from the sediment surface downward, the Hand Corer is subject to core shortening. Core shortening occurs when the length of sediment core

collected is less than the depth of sampler penetration into the sediment. Core shortening may occur when the friction of the sediment against the inside wall of the core tube increases with increasing depth of sediment penetration, causing lateral displacement of sediment and resulting in gradually thinner increments of sediment entering the sampler. Because not all layers are uniformly sampled, core shortening can introduce sampling bias.

Furthermore, use of a tripod-mounted winch limits the sampling platform locations from which the sampler can be deployed. Specifically, the sampling platform must be equipped with a hole over which the tripod-mounted winch can be placed and through which the sampler can be deployed.

## 5.2 **Vibrocorer**

The Vibrocorer is designed to collect sediment cores in deep river, lake, and ocean environments. The sampler is designed to operate in shallow and deep water conditions and to provide complete and continuous sediment profile collection to a maximum depth of 4,000 feet beneath the water surface. According to the EPA GLNPO, the sampler is designed to collect sediment cores to a depth of 15 feet bss in packed sand and to a depth of 20 feet bss in silt and clay; however, sediment cores have been successfully collected to a depth of 35 feet bss using the Vibrocorer.

### 5.2.1 *Technology Description*

Components of the Vibrocorer include (1) an anodized-aluminum, pressure-housed vibrohead with a terminal for an electric cable; (2) a disposable, 10-foot-long, 4-inch-diameter, clear plastic core tube; (3) a core tube clamp; and (4) a guide rope (see Figure 5-2). The sampler is also equipped with a check valve in the vibrohead and a core nose at the bottom end of the core tube (the check valve and core nose are not shown in Figure 5-2). Core tube sectioning and extraction are performed using a hand-held electric or battery-powered saw. The Vibrocorer requires a three-phase, 230- or 440-volt, 50- to 60-hertz electric current. The sampler must be supplied with power from a power source through an electric cable and a control box. The Vibrocorer must be operated from a boat, dock, or platform with enough working space to accommodate an A-frame of adequate size.

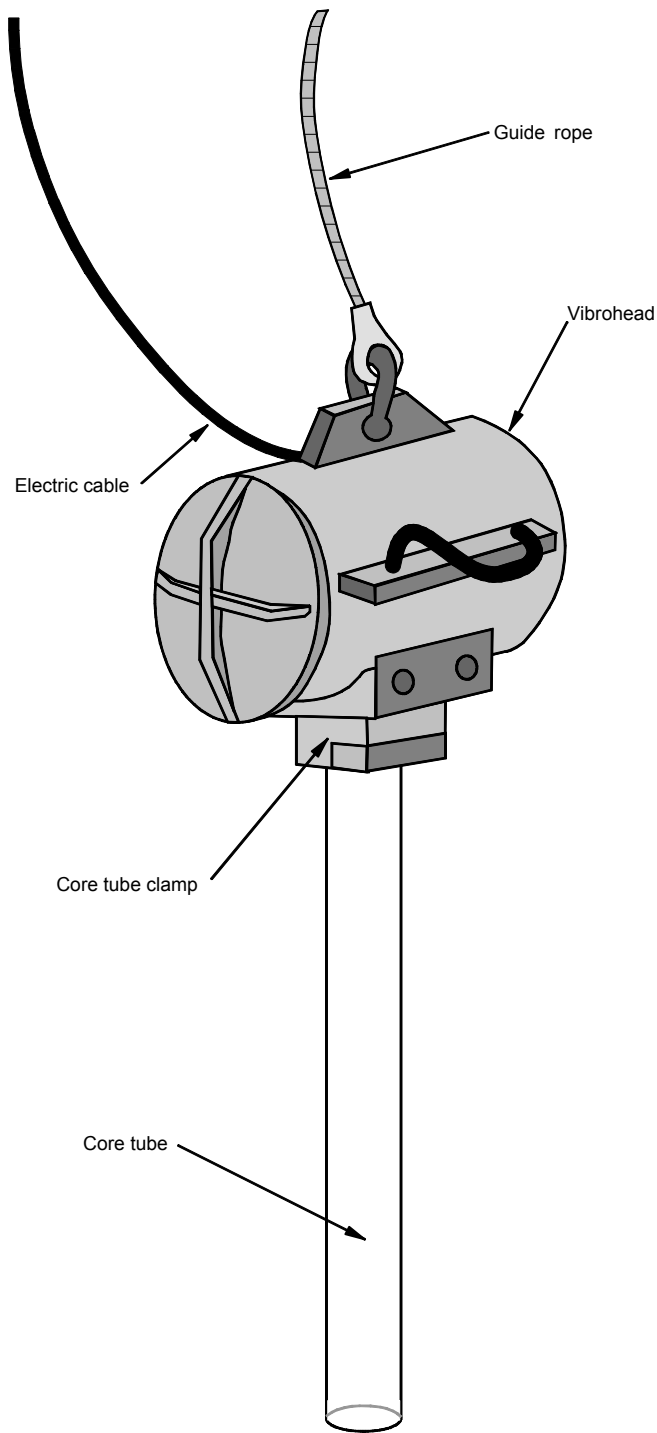

Figure 5-2. Vibrocorer.

The typical weight of a fully equipped Vibrocorer, including the vibrohead and core tube, is about 150 lb. Core tubes are available in lengths up to 15 feet with a 4-inch diameter and up to 20 feet with a 3-inch diameter.

If a 15-foot-long core sample is required, the core tube must be 16 feet long because 6 inches is lost when the core tube is inserted into the vibrohead and 6 inches is lost when the core nose is attached.

The Vibrocorer is deployed to the sediment surface using the A-frame and winch. Once the sampler is deployed to the sediment surface and supplied with power, the vibrohead vibrates at a frequency of up to 3,450 vibrations per minute, depending on the power supply. The vibrating motion of the vibrohead drives the core tube vertically downward into the sediment. The sampler is retrieved mechanically using the A-frame and winch. During sampler retrieval, the check valve in the vibrohead creates a vacuum that, along with the core nose, retains sediment in the core tube.

### 5.2.2 General Operating Procedures

The Vibrocorer must be operated by at least two persons from a boat, dock, or platform. To prepare for sampler deployment, the vibrohead is raised using the A-frame and winch, and the core tube is secured to the vibrohead at the core tube clamp. Again using the A-frame and winch, the sampler is deployed to the desired sampling position; the vibrohead should then be supplied with power and allowed to vibrate. The speed of sampler deployment to the sediment surface should be controlled to avoid bow wave formation, which could disturb flocculent or unconsolidated sediment that might be near the sediment surface (Blomqvist 1991).

As the vibrohead vibrates, the core tube is gradually forced downward into the sediment. Once the core tube is deployed to the desired sediment depth, the power can be turned off and the vibrohead can be allowed to stop vibrating. Now the sampler can be mechanically removed from the sediment using the A-frame and winch. During sampler retrieval, the check valve in the vibrohead creates a vacuum that, along with the core nose, retains sediment in the core tube. Once the core tube is retrieved from the water, water remaining in the top of the core tube should be drained by drilling holes in the core tube at the sediment-water interface with an electric or battery-powered drill. To extract the core tube from the core tube clamp, four nuts that secure the core tube in place must be removed. Afterward, the core tube is placed on the sampling platform to extract the sediment. To extract the

---

core sample, horizontal sections of the core tube should be cut using an electric or battery-powered saw.

### 5.2.3 *Advantages and Limitations*

Advantages of the Vibrocorer include its ability to collect sediment samples up to 4,000 feet beneath the water surface. In addition, the vibrohead component of the sampler allows core tube penetration into the sediment without manual labor. Sampler deployment and retrieval are controlled with an A-frame and winch. Furthermore, use of new core tubes for each sampling attempt minimizes the risk of cross-contamination between sampling locations.

A limitation of the Vibrocorer is that during sampler deployment, the disposable core tube is exposed to different layers of sediment contamination. Contaminants may adhere to the exposed surface of the core tube while

the sampler passes through different layers of sediment. In addition, the sampler cannot collect discrete samples from various sediment depths; core samples must be collected from the sediment surface downward. As a result, samples collected with the Vibrocorer are subject to core shortening as described in Section 5.1.3.

Another limitation of the Vibrocorer is that it must be operated by at least two persons from a boat, dock, or platform. If the sampler is being operated from a boat and the boat drifts away from the deployed Vibrocorer, the tension on the winch cable could pull the Vibrocorer over and damage it, or the electric cable could snap and cause an electrical short circuit. Also, if the boat drifts while the Vibrocorer is deployed, extracting the core tube from the sediment would be difficult because the winch cable from the sampler to the boat would not be vertical; as a result, the core tube could be bent and the sediment sample could be lost.



## Chapter 6

### Performance of the Russian Peat Borer

To verify a wide range of performance attributes, the innovative sediment sampler demonstration had both primary and secondary objectives. Primary objectives were critical to the technology evaluation and were intended to produce quantitative results regarding technology performance. Secondary objectives provided information that was useful but did not necessarily produce quantitative results regarding technology performance. The approach used to address each primary and secondary objective for the Russian Peat Borer and reference samplers is discussed in Chapter 4. This chapter describes the performance of the Russian Peat Borer based on the primary objectives (excluding costs associated with sample collection activities) and secondary objectives. This chapter also discusses the data quality of demonstration results for the Russian Peat Borer.

The performance of the reference samplers is discussed in Chapter 7, costs associated with sample collection activities (primary objective P7) are presented in Chapter 8, and the performance of the Russian Peat Borer and reference samplers is compared in summary form in Chapter 9.

#### 6.1 Primary Objectives

This section discusses the performance results for the Russian Peat Borer based on the primary objectives stated in Section 4.1 except for primary objective P7 (sampling costs), which is addressed in Chapter 8. Primary objectives P1 through P6 required evaluation of the Russian Peat Borer's

P1. Ability to consistently collect a specified volume of sediment

P2. Ability to consistently collect sediment in a specified depth interval

P3. Ability to collect multiple samples with consistent physical or chemical characteristics, or both, from a homogenous layer of sediment

P4. Ability to collect a representative sample from a clean sediment layer below a contaminated sediment layer

P5. Ability to be adequately decontaminated

P6. Time requirements for sample collection activities

To address primary objectives P1 through P6, samples were collected from four different areas: (1) S1A1, a river mouth; (2) S1A2, a small, freshwater bay; (3) S2A1, a lake; and (4) S2A2, a wetland. A sampling technician designated by ARI used the Russian Peat Borer to collect samples from the following target depth intervals: 0 to 4 inches bss, 6 to 12 inches bss, and 4 to 6 feet bss in S1A1; 0 to 4 and 12 to 32 inches bss in S1A2; 0 to 4 and 10 to 30 inches bss in S2A1; and 4 to 12 inches bss in S2A2. This sampler was also used to conduct sampling in the 9- to 11-foot bss target depth interval at three of the five S2A2 locations; the ARI sampling technician did not attempt to collect samples in this interval at the other two S2A2 sampling locations because of the significant effort required to collect samples at the first three locations. In some cases, multiple depth intervals were simultaneously sampled in a given attempt if the sampler was long enough to reach these intervals. The demonstration areas and target depth intervals are described in greater detail in Chapters 3 and 4. The numbers of investigative and QC



samples collected in each demonstration area, sediment sample volumes required, and sample analytical parameters are discussed in Chapter 4.

During the demonstration, ARI used three different Russian Peat Borer models to collect sediment samples: Models A, B, and C. Model A has a 20-inch-long core tube with a 2-inch inside diameter, Model B has a 40-inch-long core tube with a 2-inch inside diameter, and Model C has a 25-inch-long core tube with a 3-inch inside diameter. ARI chose which model to use based on site and area conditions and sampling requirements identified in the demonstration plan (EPA 1999). The sampling technician was also provided an opportunity to practice sample collection at each demonstration area until he felt confident enough to initiate demonstration sampling. The three Russian Peat Borer models are described in Chapter 2.

The demonstration results for the Russian Peat Borer under primary objectives P1, P2, and P4 were evaluated using the Wilk-Shapiro test to determine whether the results were normally distributed. Because most of the results were not normally distributed, the Wilk-Shapiro test was used in an attempt to evaluate whether the results followed a lognormal distribution. The test revealed that the results either were not lognormally distributed or could not be tested for lognormality because they contained values that were equal to zero. For these reasons, a parametric test such as the paired Student's t-test was not used to perform hypothesis testing. The Wilcoxon signed rank test, a nonparametric test for paired samples that makes no assumptions regarding distribution, was used as an alternative to the Student's t-test. Although the Wilcoxon signed rank test has been historically accepted as a nonparametric test, it is not as powerful as the Student's t-test because the Wilcoxon signed rank test does not account for the magnitude of difference between sample pair results. Despite this limitation, the Wilcoxon signed rank test was more appropriate than the Student's t-test for evaluating the demonstration results. A computer program known as Statistix<sup>®</sup> for Windows, Version 2.0 (Statistix<sup>®</sup>), developed by Analytical Software of Tallahassee, Florida, was used to perform statistical evaluations of the demonstration results (Analytical Software 1996). Appendix C provides details on the statistical methods used for data evaluation.

### **6.1.1 Ability to Consistently Collect a Specified Volume of Sediment**

Primary objective P1 involved evaluating the Russian Peat Borer's ability to consistently collect a specified volume of sediment. This objective was addressed by comparing (1) the actual number of sampling attempts required to collect a specified volume of sediment to the expected number of attempts (rounded to the nearest higher integer) at each sampling location in each target depth interval and (2) the actual volume of sediment collected in the specified target depth interval in each attempt to the calculated sampler volume (design volume) for the depth interval. The expected number of attempts was determined by dividing the specified sample volume by the design volume for the depth interval. The results of these comparisons are summarized below.

#### **6.1.1.1 Number of Sampling Attempts Required**

Tables 6-1 and 6-2 present the expected and actual number of sampling attempts for each depth interval at Sites 1 and 2, respectively. Initially, the Wilcoxon signed rank test was used to determine whether the difference between the expected and actual number of attempts was statistically significant. However, the conclusions drawn from the Wilcoxon signed rank test were inconsistent with the conclusions reached in comparing the expected and actual number of attempts. The discrepancy is primarily due to the test's inability to account for the magnitude of the difference between data pairs (see Appendix C for an example).

Based on the number of sampling attempts required in S1A1, the Russian Peat Borer performed well in the 0- to 4- and 6- to 12-inch bss depth intervals but had difficulty meeting expectations in the 4- to 6-foot bss depth interval. In the 0- to 4-inch bss depth interval, only one additional attempt was required at two of the five locations. The additional attempts may have been required because the sampler had difficulty collecting unconsolidated surficial sediment, which has a greater tendency to wash out because of its high water content. In the 6- to 12-inch bss depth interval, the expected number of attempts equaled the actual number of attempts at all locations. However, in the 4- to 6-foot bss depth interval, as previously mentioned, 12 attempts were required to collect the specified volume of sediment, whereas only 5 were expected. The additional attempts were required because

**Table 6-1. Comparison of Expected and Actual Number of Sampling Attempts for Russian Peat Borer at Site 1**

Location	Number of Attempts in S1A1 (River Mouth)					
	0- to 4-Inch bss Depth Interval		6- to 12-Inch bss Depth Interval		4- to 6-foot bss Depth Interval	
	Expected	Actual	Expected	Actual	Expected	Actual
1A	1	2	1	1	1	3
1E	1	1	5	5	1	1
3C	1	1	2	2	1	2
5A	1	2	3	3	1	4
5E	1	1	2	2	1	2
Total	5	7	13	13	5	12

Location	Number of Attempts in S1A2 (Freshwater Bay)			
	0- to 4-Inch bss Depth Interval		12- to 32-Inch bss Depth Interval	
	Expected	Actual	Expected	Actual
1A	1	2	1	1
1E	1	1	1	1
3C	1	2	1	1
5A	1	1	1	1
5E	1	2	2	2
Total	5	8	6	6

Note:

bss = Below sediment surface

the sampler had difficulty fully penetrating the target depth interval, which contained clay hardpan.

The Russian Peat Borer’s performance in S1A2 was similar to that in S1A1. For example, one additional attempt was required in the 0- to 4-inch bss depth interval at three of the five sampling locations in S1A2. The additional attempts may have been required because the sampler had difficulty collecting unconsolidated surficial sediment. However, in the 12- to 32-inch bss depth interval, which contained more consolidated sediment, additional attempts were not required at any of the locations sampled.

In S2A1, which was the first area sampled during the demonstration, the actual number of attempts in the 0- to 4-inch bss depth interval equaled the expected number of attempts at four of the ten locations sampled. At two of the remaining six locations, the actual number of attempts exceeded the expected number by more than one. Because these locations were the first two locations sampled, the sampling technician may have required more practice to

efficiently collect sediment samples in this demonstration area. In the 10- to 30-inch bss depth interval, five of the ten locations sampled required one additional attempt beyond the expected number of attempts; the other five locations required no additional attempts. Explanation of the additional attempts required in this depth interval was beyond the scope of the demonstration.

In S2A2, in the 4- to 12-inch bss depth interval, the Russian Peat Borer’s performance was similar to that in the 0- to 4-inch bss depth intervals in S1A1 and S1A2; one additional attempt was required in this depth interval at three of the five sampling locations in S2A2. The additional attempts may have been required because the top several inches of material in this area contained partially decomposed reeds and leaves that prevented complete closure of the sampler, which resulted in sediment washout in a few cases. In the 9- to 11-foot bss depth interval, the actual number of attempts equaled the expected number of attempts at the three locations sampled. However, samples were not collected from this interval at the two remaining locations because of the

**Table 6-2. Comparison of Expected and Actual Number of Sampling Attempts for Russian Peat Borer at Site 2**

Location	Number of Attempts in S2A1 (Lake)			
	0- to 4-Inch bss Depth Interval		10- to 30-Inch bss Depth Interval	
	Expected	Actual	Expected	Actual
1A	4	4	1	2
1B	2	2	1	1
1E	6	10	2	2
2A	5	5	2	2
2C	3	4	1	2
2D	5	6	2	2
2E	5	8	2	3
3A	3	4	1	2
3B	2	2	1	1
3E	4	5	1	2
<b>Total</b>	<b>39</b>	<b>50</b>	<b>14</b>	<b>19</b>

Location	Number of Attempts in S2A2 (Wetland)			
	4- to 12-Inch bss Depth Interval		9- to 11-foot bss Depth Interval	
	Expected	Actual	Expected	Actual
1A	1	2	1	1
1E	1	2		Not attempted
3C	1	1		Not attempted
5A	1	2	1	1
5E	1	1	1	1
<b>Total</b>	<b>5</b>	<b>8</b>	<b>3</b>	<b>3</b>

Note:

bss = Below sediment surface

significant effort required to (1) hammer the sampler into and retrieve the sampler from the 9- to 11-foot bss depth interval and (2) rotate the core tube 180 degrees clockwise to cut through the consolidated sediment.

Based on the number of sampling attempts required in all four demonstration areas and multiple sampling depth intervals, the Russian Peat Borer demonstrated the ability to consistently collect a specified volume of sediment. Overall, the sampler required 33 percent more attempts than expected (126 actual attempts versus 95 expected attempts). The Russian Peat Borer performed better than the reference samplers in the moderate and deep sampling depth intervals; however, in the shallow interval, the performance of the reference samplers was better than that of the Russian Peat Borer (see Section 7.1.1.1).

### 6.1.1.2 Volume of Sediment Collected

The volume of sediment collected by the Russian Peat Borer in each sampling attempt in a given depth interval was divided by the corresponding design volume, and the resulting ratio was multiplied by 100 to estimate the percent sample recovery (PSR). The relative standard deviation (RSD) of the PSRs was calculated to evaluate the ability of the sampler to consistently collect a specified volume of sediment; if the sampler were to recover an identical volume of sediment in every attempt, the RSD would equal zero. To properly evaluate the sampler's performance, both PSR and RSD results should be considered because a low RSD, which indicates that the sampler's performance was consistent, may be based on consistently low PSRs. Figures 6-1 and 6-2 present PSRs for the Russian Peat Borer at Sites 1 and 2, respectively.

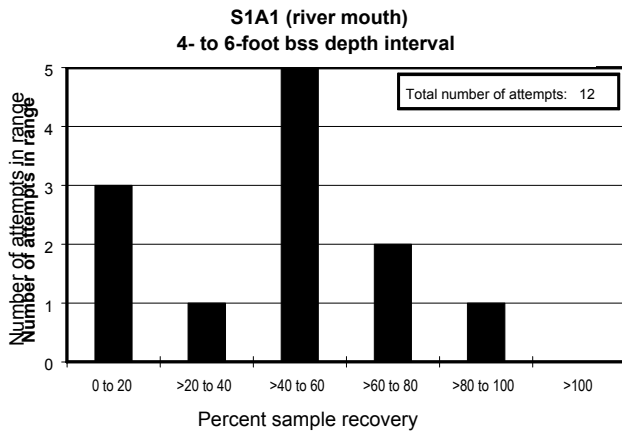
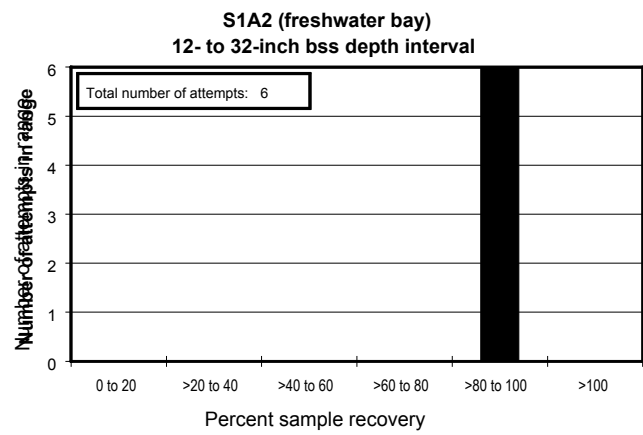
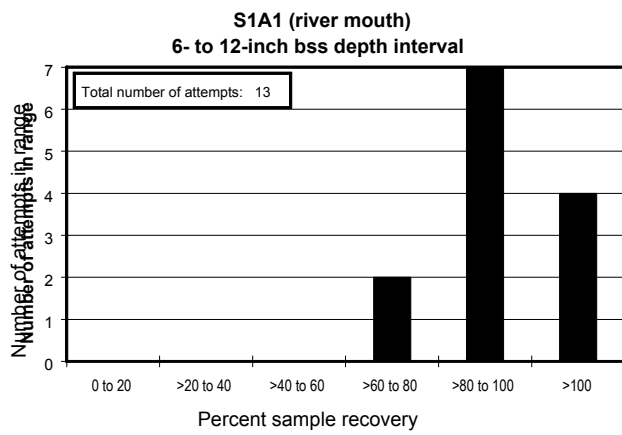
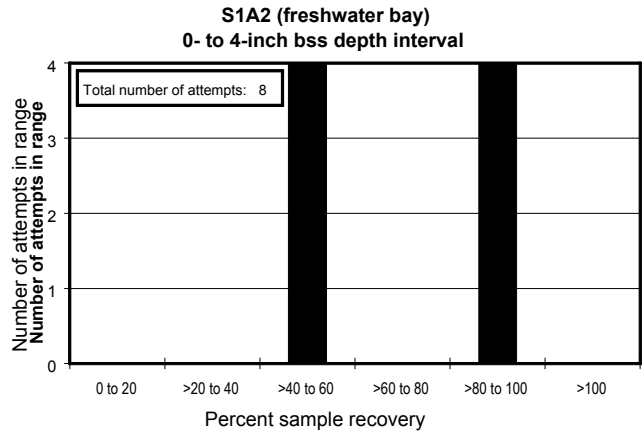
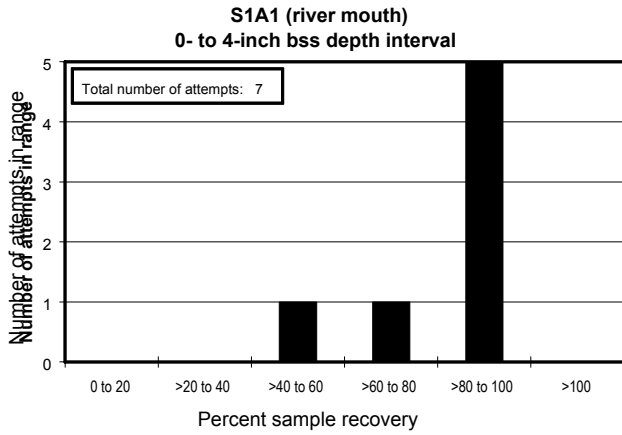

Notes:

bss = Below sediment surface

Percent sample recoveries exceeding 100 resulted from the volumetric measurement error associated with the presence of void spaces when the sediment was transferred to a graduated container.

Figure 6-1. Percent sample recoveries for Russian Peat Borer at Site 1.

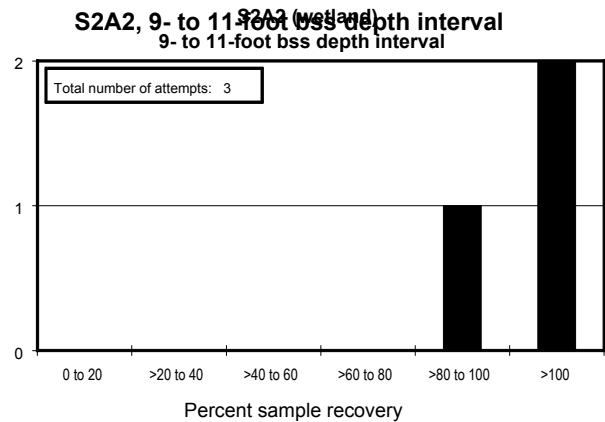
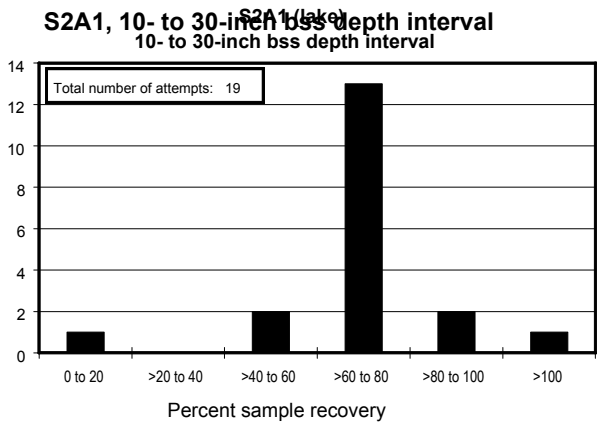
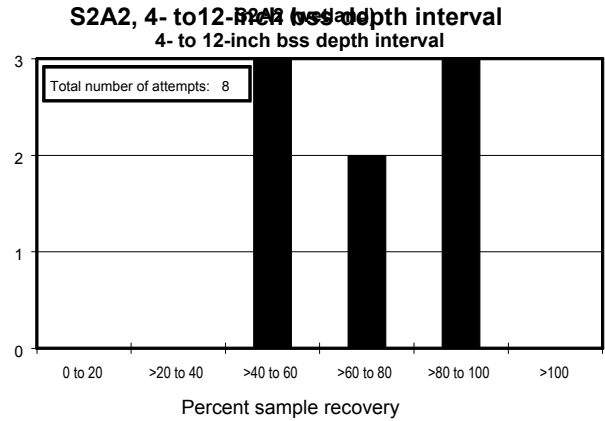
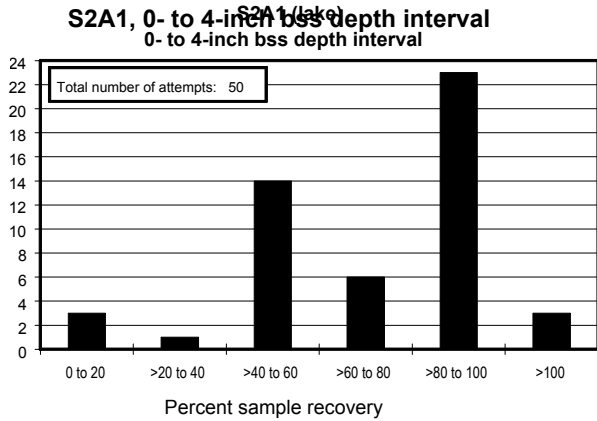

Notes:

bss = Below sediment surface

Percent sample recoveries exceeding 100 resulted from the volumetric measurement error associated with the presence of void spaces when the sediment was transferred to a graduated container.

Figure 6-2. Percent sample recoveries for Russian Peat Borer at Site 2.

Table 6-3 presents PSR summary statistics (range, mean, and RSD) for the Russian Peat Borer at both sites.

In S1A1, the Russian Peat Borer performed well in terms of PSR in the 0- to 4- and 6- to 12-inch bss depth intervals but had difficulty meeting expectations in the 4- to 6-foot bss depth interval. In the 0- to 4-inch bss depth interval, the sampler retrieved sediment in every attempt; difficulties in collecting unconsolidated surficial sediment may account for the minimum PSR of 44 for this depth interval. Because the sediment was more consolidated in the 6- to 12-inch bss depth interval, improved sample recoveries were observed, as is reflected by the minimum

PSR of 67. The RSDs for the 0- to 4- and 6- to 12-inch bss depth intervals are about the same and are less than 30 percent. Although no RSD criterion has been set for determining the ability to consistently sample a specified volume of sediment, an RSD of 30 percent or less is considered to be acceptable. The RSDs show that the Russian Peat Borer was able to consistently sample the 0- to 4- and 6- to 12-inch bss depth intervals.

In the 4- to 6-foot bss depth interval, several additional attempts were required to collect the specified volume of sediment because (1) in one attempt, the core tube was not fully rotated to the closed position and (2) in the remaining

**Table 6-3. Percent Sample Recovery Summary Statistics for Russian Peat Borer**

Demonstration Area	Target Depth Interval (bss)	Actual Number of Attempts	PSR Range <sup>a</sup>	Mean PSR	RSD (%)
S1A1 (river mouth)	0 to 4 inches	7	44 to 100	84	26
	6 to 12 inches	13	67 to 133	101	25
	4 to 6 feet	12	0 to 100	45	71
S1A2 (freshwater bay)	0 to 4 inches	8	50 to 100	75	36
	12 to 32 inches	6	90 to 100	95	6
S2A1 (lake)	0 to 4 inches	50	0 to 110	71	42
	10 to 30 inches	19	0 to 110	76	30
S2A2 (wetland)	4 to 12 inches	8	50 to 100	75	31
	9 to 11 feet	3	100 to 133	122	16

Notes:

- bss = Below sediment surface
- PSR = Percent sample recovery
- RSD = Relative standard deviation

<sup>a</sup> PSRs exceeding 100 resulted from the volumetric measurement error associated with the presence of void spaces when the sediment was transferred to a graduated container.

attempts, the sampler had difficulties penetrating the entire target depth interval, which contained clay hardpan. As a result, in 9 of the 12 attempts in this interval, less than or equal to 60 percent of the specified volume was retrieved; in 3 of the 9 attempts, no sediment was retrieved. Consequently, a high RSD (71 percent) was observed for the 4- to 6-foot bss depth interval, indicating that the Russian Peat Borer did not demonstrate the ability to consistently collect a specified volume of sediment in this interval.

In the S1A2 0- to 4-inch bss depth interval, the Russian Peat Borer had slightly more difficulty in collecting unconsolidated sediment than it did in the same interval in S1A1. However, the sampler performed well in the 12- to 32-inch bss depth interval in S1A2, which contained consolidated sediment. Table 6-3 shows that the mean PSR for the 0- to 4-inch bss depth interval in S1A2 is less than that for the 0- to 4-inch bss depth interval in S1A1. The lower PSR values for the 0- to 4-inch bss depth interval in S1A2 can be attributed to difficulty in collecting unconsolidated surficial sediment, as is reflected in the four attempts with PSRs in the greater than 40 to 60 range shown in Figure 6-1. The variability in the PSRs for the 0- to 4-inch bss depth interval is reflected in the RSD of 36 percent, which slightly exceeds the 30 percent RSD guideline discussed above. On the other hand, the Russian Peat Borer achieved a mean PSR of 95 and a PSR range of 90 to 100 for samples collected in the

12- to 32-inch bss depth interval, as shown in Table 6-3. The sampler’s consistency of performance in this depth interval was reflected in an RSD of 6 percent and may have been achieved because the sediment in this interval was highly cohesive.

Wide PSR ranges (0 to 110) were observed in the 0- to 4- and 10- to 30-inch bss depth intervals in S2A1. As shown in Table 6-3, the mean PSR of 71 and the minimum PSR of 0 for the 0- to 4-inch bss depth interval in S2A1 were low compared to those for the other 0- to 4-inch bss depth intervals. Figure 6-2 shows the variability in PSR values observed for the 0- to 4-inch bss depth interval in S2A1, where 26 of the 50 attempts had PSRs greater than 80, but 14 attempts had PSRs in the greater than 40 to 60 range. The high variability in the PSR results for the 0- to 4-inch bss depth interval is further reflected by the high RSD value of 42 percent. Although a similar mean PSR (76) and minimum PSR (0) were observed for the 10- to 30-inch bss depth interval in S2A1, much less variability was present in the PSR data. As shown in Figure 6-2, only 6 of the 19 attempts had PSRs outside the greater than 60 to 80 range. Because most recoveries fell into a narrow range (greater than 60 to 80 range), an RSD value of 30 percent was observed, which met the 30 percent RSD guideline. In both the 0- to 4- and 10- to 30-inch bss depth intervals in S2A1, at least some sediment was collected in most attempts; no sediment was collected in only 3 of 50



and 1 of 19 attempts in the 0- to 4- and 10- to 30-inch bss depth intervals, respectively.

In S2A2, the Russian Peat Borer experienced some difficulty in the 4- to 12-inch bss depth interval but performed well in the 9- to 11-foot bss depth interval. In the 4- to 12-inch bss depth interval, a mean PSR of 75 and a PSR range of 50 to 100 were observed, as shown in Table 6-3. As shown in Figure 6-2, only three of eight attempts in this interval had PSRs greater than 80, with washout accounting for the low recoveries. However, an RSD of 31 percent was calculated for the PSRs for the 4- to 12-inch bss depth interval, which compares favorably to the 30 percent RSD guideline. In the 9- to 11-foot bss depth interval, a mean PSR of 122 and a PSR range of 100 to 133 were observed because PSRs for two attempts were in excess of 100. The Russian Peat Borer performed well at the 9- to 11-foot bss depth interval because the cohesiveness of the peat at this depth eliminated the possibility of washout. The RSD for the 9- to 11-foot bss depth interval was only 16 percent.

Based on the volumes of sediment collected in all four demonstration areas and multiple sampling depth intervals, the Russian Peat Borer demonstrated the ability to consistently collect a specified volume of sediment. An RSD less than or equal to 30 percent was observed for five of nine sampling depth intervals. Three of the remaining depth intervals had an RSD in the greater than 30 to 50 percent range. Only one depth interval had an RSD that exceeded 50 percent. The sampler had mixed results in the 0- to 4-inch bss depth intervals, for which RSDs of 26, 36, and 42 percent were observed in S1A1, S1A2, and S2A1, respectively. The sampler performed better at moderate depth intervals, for which RSDs of 25, 6, 30, and 31 percent were observed in S1A1, S1A2, S2A1, and S2A2, respectively. Mixed results were also observed in the deepest sampling intervals. For sample collection from the cohesive peat of the 9- to 11-foot bss depth interval in S2A2, an RSD of 16 percent was observed. In contrast, the sampler's difficulty in penetrating the clay hardpan in the 4- to 6-foot depth interval in S1A1 resulted in an RSD of 71 percent. Overall, the Russian Peat Borer performed better than the reference samplers in the moderate and deep sampling depth intervals; however, in the shallow interval, the performance of the reference samplers was better than the Russian Peat Borer (see Section 7.1.1.2).

### **6.1.2 Ability to Consistently Collect Sediment in a Specified Depth Interval**

Primary objective P2 involved evaluating the Russian Peat Borer's ability to consistently collect sediment in a specified depth interval. This objective was addressed by comparing actual and target core lengths for each sampling attempt. The target core length for an attempt was equal to the distance between the upper and lower boundaries of a depth interval except in the case of samples collected from the 4- to 6-foot bss depth interval in S1A1 and the 9- to 11-foot bss depth interval in S2A2, where the target core length was set at 20 inches to correspond to the Russian Peat Borer Model A's core tube length. The actual core lengths were generally 2 to 6 inches greater than the estimated depth of sampler deployment for the shallow and moderate depth intervals, indicating that the sampling technician may have had minor difficulty in assessing the location of the sediment surface. Because the Russian Peat Borer is a side-filling sampler that, based on visual observations, collects a relatively uncompressed sediment sample, the error in assessing the location of the sediment surface should have minimal effect on the core length data. Also, the actual core length measurements presented in this section do not account for void space in the core, rounding error, or sediment washout. Consequently, an attempt may have achieved an actual core length that equaled the target core length but may not have resulted in a PSR of 100.

Table 6-4 presents the number of attempts in which the actual core length equaled the target core length, target core lengths, and mean actual core lengths. Initially, the Wilcoxon signed rank test was to be used to determine whether differences between the actual and target core lengths were statistically significant. However, review of the Wilcoxon signed rank test results revealed that the test results for many of the data sets were inconsistent with the conclusions reached in comparing the actual and expected core lengths for the reasons described in Section 6.1. Therefore, primary objective P2 was addressed by evaluating (1) the number of attempts in which the actual core length equaled the target core length and (2) the difference between the target core length and the mean actual core length.

In S1A1, the sample core lengths equaled the target core lengths for all samples collected from the 0- to 4- and 6- to 12-inch bss depth intervals. However, only 1 of 12



**Table 6-4. Comparison of Target and Actual Core Length Data for Russian Peat Borer**

Demonstration Area	Target Depth Interval (bss)	Number of Attempts in Which Actual Core Length Equaled Target Core Length/Total Attempts	Target Core Length (inches)	Mean Actual Core Length (inches)
S1A1 (river mouth)	0 to 4 inches	7/7	4	4
	6 to 12 inches	13/13	6	6
	4 to 6 feet	1/12	20	10
S1A2 (freshwater bay)	0 to 4 inches	8/8	4	4
	12 to 32 inches	6/6	20	20
S2A1 (lake)	0 to 4 inches	49/50	4	~4 <sup>a</sup>
	10 to 30 inches	16/19	20	18
S2A2 (wetland)	4 to 12 inches	8/8	8	8
	9 to 11 feet	3/3	20	20

Note:

bss = Below sediment surface

<sup>a</sup> The calculated mean actual core length (3.9 inches) was rounded to the nearest integer.

sample core lengths in the 4- to 6-foot bss depth interval equaled the target core length. This circumstance resulted in a mean actual core length of 10 inches, which is only one-half the target core length of 20 inches. Because of difficulties in penetrating the clay hardpan in the 4- to 6-foot bss depth interval, 11 of the 12 attempts obtained a core length of less than 20 inches; in 3 of the 12 attempts, no sediment was retrieved. The reference sampler also had difficulty penetrating the clay hardpan to the extent that it was unable to collect samples from this interval at S1A1.

In S1A2, the Russian Peat Borer successfully collected the target core lengths in all attempts in both the 0- to 4- and 12- to 32-inch bss depth intervals.

The Russian Peat Borer also performed well in S2A1, where the core lengths of 49 of 50 and 16 of 19 samples equaled the target core lengths in the 0- to 4- and 10- to 30-inch bss depth intervals, respectively. In the 0- to 4-inch bss depth interval, one attempt where no sediment was collected was the only failure to obtain the target core length. Despite this attempt, the mean actual core length was about 4 inches (3.9 inches). In the 10- to 30-inch bss depth interval, there was also one attempt in which no sediment was collected. This failed attempt accounts for most of the mean actual core length's deviation from the target core length. The mean actual core length was 18 inches, which still compares favorably to the target core length of 20 inches.

In S2A2, the Russian Peat Borer successfully collected the target core lengths in all attempts in both the 4- to 12-inch and 9- to 11-foot bss depth intervals. As discussed in Section 7.1, the reference sampler was not used for the 9- to 11-foot bss depth interval because it is not designed to collect samples below 3 feet bss.

In summary, the data indicate that the Russian Peat Borer was able to consistently collect sediment from the shallow (0- to 4-inch bss) and moderate (6- to 12-inch bss in S1A1, 12- to 32-inch bss in S1A2, 10- to 30-inch bss in S2A1, and 4- to 12-inch bss in S2A2) depth intervals. In the 0- to 4-inch bss depth interval, only 1 of 65 actual core lengths did not match the target core length. In the moderate depth intervals, only 3 of 46 actual core lengths did not match the target core length. The Russian Peat Borer performed as well as or better than the reference samplers (see Section 7.1.2).

A general conclusion could not be drawn regarding the Russian Peat Borer's ability to consistently collect sediment from the deep (4- to 6-foot bss in S1A1 and 9- to 11-foot bss in S2A2) depth intervals. In S1A1, only 1 of 12 actual core lengths in the 4- to 6-foot bss depth interval equaled the target core length, but in S2A2, all 3 actual core lengths in the 9- to 11-foot bss depth interval equaled the target core length. As discussed in Section 7.1, the 4- to 6- and 9- to 11-foot bss depth intervals could not be sampled using the reference sampler.

### **6.1.3 Ability to Collect Multiple Samples with Consistent Physical or Chemical Characteristics, or Both, from a Homogenous Layer of Sediment**

Primary objective P3 involved evaluating the Russian Peat Borer's ability to collect multiple samples with consistent physical or chemical characteristics, or both, from a homogenous layer of sediment. This objective was addressed by calculating the RSD values for the sample analytical results for the 12- to 32-inch bss depth interval in S1A2 and the 0- to 4- and 10- to 30-inch bss depth intervals in S2A1. Based on the predemonstration investigation results, these three depth intervals were determined to be homogenous in terms of their physical characteristics, and the two S2A1 depth intervals were determined to be homogenous in terms of their physical and chemical characteristics.

Figure 6-3 presents the demonstration analytical results for PSD in the 12- to 32-inch bss depth interval in S1A2. Figure 6-4 presents the demonstration analytical results for arsenic and PSD in the 0- to 4- and 10- to 30-inch bss depth intervals in S2A1. The demonstration analytical results for arsenic contain statistical outliers that indicate that the two S2A1 depth intervals may not be chemically homogenous. For this evaluation, the outliers are defined as sample analytical results that are not within two standard deviations of the mean; the outliers include the 12 milligrams per kilogram (mg/kg) of arsenic in the 0- to 4-inch bss depth interval and the 29 mg/kg of arsenic in the 10- to 30-inch bss depth interval in S2A1. Outliers were also found in the arsenic analytical results for samples collected by the reference sampler (see Section 7.1.3), providing further evidence that the two S2A1 depth intervals may not be chemically homogenous. A similar analysis performed for the PSD data revealed no statistical outliers. Therefore, the Russian Peat Borer was evaluated based only on its ability to collect multiple samples with consistent physical characteristics. RSDs were calculated for each depth interval based on the PSD results for all locations sampled.

RSDs calculated for the PSD data were compared to the laboratory acceptance criterion of 15 percent for field triplicates (which was based on historical information) because RSDs less than or equal to 15 percent for all samples collected in a given depth interval and area may

be more attributable to the laboratory's precision than the sampler's ability to collect multiple samples with consistent physical characteristics. When the RSD for all samples from a given depth interval was greater than 15 percent, it was compared to the measured RSD for the field triplicates, which were prepared by first homogenizing and then subsampling the sediment collected in a given depth interval, location, and area. An RSD for all samples that is less than the RSD for field triplicates may be more attributable to the laboratory's analytical procedure or the sample homogenization procedure implemented in the field, or both, rather than the sampler's ability to collect physically consistent samples. However, PSD parameters with means less than 10 percent were not evaluated in this manner because at low levels, the analytical method is not as precise; as a result, it will generate high RSD values and may not actually reveal whether multiple samples with consistent physical characteristics were collected. Table 6-5 presents PSD summary statistics (range, mean, and RSD) calculated for the samples and field triplicates collected in each depth interval relevant to primary objective P3.

For the 12- to 32-inch bss depth interval in S1A2, the mean sand level was less than 10 percent and was not evaluated using the laboratory acceptance criterion of 15 percent RSD. Although the mean sand level was less than 10 percent, all investigative samples contained some sand level as indicated by 0 percent RSD. The RSDs for sand and silt results were below the 15 percent laboratory acceptance criterion. However, the 18 percent RSD for clay results for this depth interval was 3 percentage points above the laboratory acceptance criterion and 15 percentage points above the measured RSD for field triplicates. Therefore, some of the variation in the clay results may be attributable to the Russian Peat Borer's ability to collect samples with consistent physical characteristics. The variation, however, was not considered significant because it was only 3 percentage points greater than the laboratory acceptance criterion.

For both of the S2A1 depth intervals, the RSDs for sand and silt results were below the 15 percent laboratory acceptance criterion. The mean clay levels were less than 10 percent and were not evaluated using this criterion. However, the clay levels exhibited tight ranges (2 to 8 percent in the 0- to 4-inch bss depth interval and 2 to 9 percent in the 10- to 30-inch bss depth interval).

12- to 32-inch bss depth interval

<b>Location 1A</b> Sand: 1% Silt: 74% Clay: 25%				<b>Location 1E</b> Sand: 1% Silt: 82% Clay: 17%
		<b>Location 3C</b> Sand: 1% Silt: 79% Clay: 20%		
<b>Location 5A</b> Sand: 1% Silt: 73% Clay: 26%				<b>Location 5E</b> Sand: 1% Silt: 79% Clay: 20%

Note:

bss = Below sediment surface

Figure 6-3. Russian Peat Borer sample particle size distribution results for S1A2 (freshwater bay).

In summary, the Russian Peat Borer met primary objective P3 criteria except for (1) a 3 percentage point exceedance in the RSD for clay results for S1A2 and (2) exceedances up to 44 percentage points in the RSDs for clay results for S2A1. The S2A1 exceedance may be due to a low mean clay content at which the analytical method’s precision is generally low. Therefore, it was concluded that the Russian Peat Borer was able to collect multiple samples with consistent physical characteristics. Similar performance results were observed for the reference sampler (see Section 7.1.3).

**6.1.4 Ability to Collect a Representative Sample from a Clean Sediment Layer Below a Contaminated Sediment Layer**

To evaluate whether the Russian Peat Borer could collect representative samples from a clean sediment layer that was below a contaminated layer (primary objective P4), samples were collected from both clean and contaminated layers using the Russian Peat Borer and the Hand Corer (reference sampler). Because the predemonstration

**0- to 4-inch bss depth interval**

<b>Location 1A</b> Arsenic: 220 mg/kg  Sand: 31% Silt: 66% Clay: 2%	<b>Location 1B</b> Arsenic: 210 mg/kg			<b>Location 1E</b> Arsenic: 180 mg/kg  Sand: 26% Silt: 48% Clay: 7%
<b>Location 2A</b> Arsenic: 230 mg/kg		<b>Location 2C</b> Arsenic: 12 mg/kg  Sand: 29% Silt: 60% Clay: 8%	<b>Location 2D</b> Arsenic: 240 mg/kg	<b>Location 2E</b> Arsenic: 190 mg/kg
<b>Location 3A</b> Arsenic: 300 mg/kg  Sand: 30% Silt: 63% Clay: 3%	<b>Location 3B</b> Arsenic: 250 mg/kg			<b>Location 3E</b> Arsenic: 190 mg/kg  Sand: 35% Silt: 55% Clay: 3%

**10- to 30-inch bss depth interval**

<b>Location 1A</b> Arsenic: 12 mg/kg  Sand: 37% Silt: 58% Clay: 5%	<b>Location 1B</b> Arsenic: 9 mg/kg			<b>Location 1E</b> Arsenic: 29 mg/kg  Sand: 37% Silt: 57% Clay: 4%
<b>Location 2A</b> Arsenic: 10 mg/kg		<b>Location 2C</b> Arsenic: 18 mg/kg  Sand: 34% Silt: 57% Clay: 9%	<b>Location 2D</b> Arsenic: 10 mg/kg	<b>Location 2E</b> Arsenic: 14 mg/kg
<b>Location 3A</b> Arsenic: 11 mg/kg  Sand: 34% Silt: 62% Clay: 4%	<b>Location 3B</b> Arsenic: 9.9 mg/kg			<b>Location 3E</b> Arsenic: 11 mg/kg  Sand: 37% Silt: 61% Clay: 2%

Notes:

bss = Below sediment surface  
 mg/kg = Milligram per kilogram

The particle size distribution results for a given sample may not total 100 percent because of rounding or because some sediment did not pass through a U.S. Standard No. 4 sieve and was classified as gravel rather than sand, silt, or clay.

Figure 6-4. Russian Peat Borer sample arsenic and particle size distribution results for S2A1 (lake).

**Table 6-5. Particle Size Distribution Summary Statistics for Russian Peat Borer**

Demonstration Area	Target Depth Interval (inches bss)	Number of Samples	Parameter	Range (%)	Mean (%)	RSD (%) (All Samples)	RSD (%) (Field Triplicates)
S1A2 (freshwater bay)	12 to 32	5	Sand	1	1	0	0
		5	Silt	73 to 82	77	5	1
		5	Clay	17 to 26	22	18	3
S2A1 (lake)	0 to 4	5	Sand	26 to 35	30	11	19
		5	Silt	48 to 66	58	12	9
		5	Clay	2 to 8	5	59	33
	10 to 30	5	Sand	34 to 37	36	5	12
		5	Silt	57 to 62	59	4	8
		5	Clay	2 to 9	5	55	83

Notes:

- bss = Below sediment surface
- RSD = Relative standard deviation

investigation results indicated that the 10- to 30-inch bss depth interval in S2A1 contained arsenic concentrations that were an order of magnitude less than those in the 0- to 4-inch bss depth interval in S2A1, the 10- to 30- and 0- to 4-inch bss depth intervals were considered to be clean and contaminated layers, respectively. Difficulties were encountered in assessing the location of the sediment surface in this demonstration area because a black, gelatinous material was present near the sediment surface. In addition, the location of the sediment surface varied significantly at several of the grid locations. This variation may have been caused by previous sampling attempts made during the demonstration.

Samples collected from both sediment layers were analyzed for arsenic. The contaminated layer concentrations were used only to document that a contaminated layer existed above the clean layer. The clean layer concentrations were used to compare the Russian Peat Borer’s performance with that of the Hand Corer. To make this comparison, the null hypothesis was that the mean difference between the Russian Peat Borer and Hand Corer sample arsenic concentrations for the clean layer equaled zero. The alternative hypothesis was that the mean difference between the Russian Peat Borer and Hand Corer sample arsenic concentrations for the clean layer was not equal to zero. A two-tailed Wilcoxon signed rank test was used to compare the Russian Peat Borer and Hand Corer sample concentrations.

Figure 6-5 presents the arsenic concentrations in the samples collected by the Russian Peat Borer and the Hand

Corer in both depth intervals in S2A1. Figure 6-5 also presents the difference between the arsenic concentrations in the samples collected by the samplers in the 10- to 30-inch bss depth interval at each sampling location by subtracting the arsenic concentration in the Hand Corer sample from that in the Russian Peat Borer sample. Each negative difference indicates that the sample collected by the Russian Peat Borer was less impacted by the contaminated layer than the sample collected by the Hand Corer; each positive difference indicates that the reverse was true.

The sample analytical results showed that the 0- to 4-inch bss depth interval contained arsenic at levels an order of magnitude greater than the 10- to 30-inch bss depth interval, although a few anomalies were noted. Two of these anomalies are the (1) 12 mg/kg of arsenic in the Russian Peat Borer sample collected from the 0- to 4-inch bss depth interval and (2) 52 mg/kg of arsenic in the Hand Corer sample collected from the 10- to 30-inch bss depth interval. Explanation of these anomalies was beyond the scope of the demonstration.

A statistical comparison of the Russian Peat Borer and Hand Corer sample arsenic concentrations for the clean layer using the Wilcoxon signed rank test showed that there was a 61 percent probability that the concentrations were not different. This conclusion seems reasonable based on the average difference between the Russian Peat Borer and Hand Corer sample concentrations, which was about -2.0 mg/kg. This average was skewed by the anomalous paired observation at location 3E (11 and

**0- to 4-inch bss depth interval**

<b>Location 1A</b> RPB: 220 mg/kg HDC: 250 mg/kg	<b>Location 1B</b> RPB: 210 mg/kg HDC: 130 mg/kg			<b>Location 1E</b> RPB: 180 mg/kg HDC: 190 mg/kg
<b>Location 2A</b> RPB: 230 mg/kg HDC: 190 mg/kg		<b>Location 2C</b> RPB: 12 mg/kg HDC: 120 mg/kg	<b>Location 2D</b> RPB: 240 mg/kg HDC: 130 mg/kg	<b>Location 2E</b> RPB: 190 mg/kg HDC: 150 mg/kg
<b>Location 3A</b> RPB: 300 mg/kg HDC: 140 mg/kg	<b>Location 3B</b> RPB: 250 mg/kg HDC: 140 mg/kg			<b>Location 3E</b> RPB: 190 mg/kg HDC: 130 mg/kg

**10- to 30-inch bss depth interval**

<b>Location 1A</b> RPB: 12 mg/kg HDC: 24 mg/kg  Diff: -12 mg/kg	<b>Location 1B</b> RPB: 9 mg/kg HDC: 8.5 mg/kg  Diff: 0.5 mg/kg			<b>Location 1E</b> RPB: 29 mg/kg HDC: 16 mg/kg  Diff: 13 mg/kg
<b>Location 2A</b> RPB: 10 mg/kg HDC: 8.3 mg/kg  Diff: 1.7 mg/kg		<b>Location 2C</b> RPB: 18 mg/kg HDC: 9.7 mg/kg  Diff: 8.3 mg/kg	<b>Location 2D</b> RPB: 10 mg/kg HDC: 13 mg/kg  Diff: -3 mg/kg	<b>Location 2E</b> RPB: 14 mg/kg HDC: 7.2 mg/kg  Diff: 6.8 mg/kg
<b>Location 3A</b> RPB: 11 mg/kg HDC: 7.2 mg/kg  Diff: 3.8 mg/kg	<b>Location 3B</b> RPB: 9.9 mg/kg HDC: 8.2 mg/kg  Diff: 1.7 mg/kg			<b>Location 3E</b> RPB: 11 mg/kg HDC: 52 mg/kg  Diff: -41 mg/kg

Notes:

- bss = Below sediment surface
- Diff = Difference between arsenic concentrations in Russian Peat Borer and Hand Corer samples
- HDC = Hand Corer
- mg/kg = Milligram per kilogram
- RPB = Russian Peat Borer

Figure 6-5. Comparison of Russian Peat Borer and reference sampler sample arsenic concentration results for S2A1 (lake).



52 mg/kg of arsenic in the Russian Peat Borer and Hand Corer samples, respectively). If the paired observation at location 3E is not considered, the average difference in concentrations is about 2.3 mg/kg, which is still comparable to zero because the reporting limit for arsenic was 1.0 mg/kg.

In summary, the Russian Peat Borer collected samples from the clean layer that were at least as representative as those collected by the Hand Corer.

### 6.1.5 Ability to be Adequately Decontaminated

Primary objective P5 involved evaluating the Russian Peat Borer’s ability to be adequately decontaminated (see Section 4.3). This objective was addressed by collecting equipment rinsate samples after sampler decontamination activities in S1A1 and S2A1. Specifically, the 6- to 12-inch bss depth interval in S1A1 and the 0- to 4-inch bss depth interval in S2A1 were chosen as the depth intervals where P5 was evaluated because they contained high concentrations of PCBs and arsenic, respectively. Although it was intended that the evaluation of P5 be limited to these depth intervals, this was not possible because ARI simultaneously collected samples in multiple depth intervals. However, this deviation did not impact the primary objective. If the sampler were adequately decontaminated, the analytical results for the equipment rinsate samples would be below the analytical laboratory’s reporting limits. To ensure that the water used to decontaminate the sampler was not contaminated, decontamination water blanks were also analyzed. Contaminant concentrations in both the equipment rinsate samples and decontamination water blanks were below the laboratory reporting limits for PCBs (1 part per billion) and arsenic (10 parts per billion). Thus, the Russian Peat Borer demonstrated the ability to be adequately decontaminated.

### 6.1.6 Time Requirements for Sample Collection Activities

Primary objective P6 involved evaluating the Russian Peat Borer’s time requirements for sample collection activities. These requirements were evaluated in all four demonstration areas but were not specifically evaluated by depth interval because samples were simultaneously collected in multiple depth intervals to reduce the total sample collection time. One technician was required for sampler setup, sample collection, sampler disassembly, and sampler decontamination in each area. The amounts of time measured to complete these activities are shown in Table 6-6. The time measured for sample collection activities did not include the time taken for mobilization, demobilization, and maneuvering the sampling platforms to access sampling locations because these activities were not specific to the sampler; they were either site- or weather-related.

A comparison of sampler setup time results showed that the setup time ranged from 1 to 30 minutes. In S1A1, samples were collected using Russian Peat Borer Models A and C. Similarly, S2A1 samples were collected using Models B and C, but a longer setup time was required in S2A1, perhaps because S2A1 was the first area sampled during the demonstration and because three more extension rods were used in S2A1 than in S1A1. Only one Russian Peat Borer model was used in S1A2 (Model B) and S2A2 (Model A). However, more time was required in S2A2 because three extension rods were required to reach the 9- to 11-foot bss depth interval, whereas only one extension rod was required in S1A2. Use of the additional extension rods in S2A2 contributed to the additional 8 minutes of setup time.

**Table 6-6. Time Required to Complete Sampling Activities for Russian Peat Borer**

Activity	Time Required (minutes)			
	S1A1 (River Mouth)	S1A2 (Freshwater Bay)	S2A1 (Lake)	S2A2 (Wetland)
Sampler Setup	13	1	30	9
Sample Collection	52	8	80	120
Sampler Disassembly	10	3	9	9
Sampler Decontamination	13	Not evaluated	30	Not evaluated
Total	88	12	149	138

Sample collection times ranged from 8 to 120 minutes. Sample collection time was a function of how many attempts were required in each depth interval and of demonstration area characteristics such as water depth and target sampling depth intervals. Sampling attempts in depth intervals other than the 4- to 6-foot bss depth interval in S1A1 and the 9- to 11-foot bss depth interval in S2A2 required 1 minute or less except in S2A1. Again, additional time was necessary for sample collection in S2A1 because it was the first area sampled and because the water depth was 18 feet. Sample collection times in S2A1 ranged from 1 to 4 minutes per attempt. Sample collection times in the 4- to 6-foot bss depth interval in S1A1 and the 9- to 11-foot bss depth interval in S2A2 ranged from 2 to 4 and 30 to 51 minutes per attempt, respectively. The additional time required to sample these intervals can be attributed to their greater depths.

The sampler disassembly time was fairly consistent. About 10 minutes was required for sampler disassembly in all areas except S1A2, where 3 minutes was required. The time required to disassemble one sampler model in S2A2 was comparable to the time required to disassemble two sampler models in S1A1 and S2A1 because of the numerous extension rods required to sample the 9- to 11-foot bss depth interval in S2A2. Less time was expended in sampler disassembly in S1A2 than in the other areas because only one sampler model and one extension rod were required in S1A2.

The amount of time spent on Russian Peat Borer decontamination was evaluated only in S1A1 and S2A1. In both areas, the amounts of time required for sampler setup and sampler decontamination were identical (13 minutes in S1A1 and 30 minutes in S2A1). Although two sampler models were used in both areas, more decontamination time was necessary in S2A1 because it was the first area where the sampling technician implemented the decontamination procedure and because more extension rods had to be decontaminated. Four extension rods were required in S1A1, and six were required in S2A1.

Based on the demonstration results, a sampling technician with some previous experience with the Russian Peat Borer would need 5 to 10 minutes per sampler model for each of the following activities: (1) sampler setup, (2) sampler disassembly, and (3) sampler decontamination. The actual amount of time required for

these activities would depend on the sampling technician's familiarity with the Russian Peat Borer and on the number of extension rods needed to collect samples. Approximately 1 to 2 minutes per sampling attempt could be expected for sample collection. However, sample collection time increases as the degree of sediment compaction, the water depth, and the depth of the interval to be sampled increase. When sediment sampling is planned, the time required for setting up the sampling platform and for maneuvering the platform to position the sampler at the sampling location would have to be considered in addition to the times presented above.

## 6.2 Secondary Objectives

This section discusses the performance results for the Russian Peat Borer based on the secondary objectives stated in Section 4.1. Secondary objectives S1 through S5 required evaluation of the Russian Peat Borer's

- S1. Skill and training requirements for proper sampler operation
- S2. Ability to collect samples under a variety of site conditions
- S3. Ability to collect an undisturbed sample
- S4. Durability based on materials of construction and engineering design
- S5. Availability, including spare part availability

Secondary objectives were addressed based on (1) observations of the Russian Peat Borer's performance during the demonstration and (2) information provided by ARI and by a developer of material used in the construction of the Russian Peat Borer.

### 6.2.1 Skill and Training Requirements for Proper Sampler Operation

The Russian Peat Borer is easy to operate, requiring minimal skills and training. Although ARI currently does not have a training video or written SOP for the sampler, sampler assembly and sample collection procedures can be learned in the field with a few practice attempts. The sampler can be operated by one person because of its lightness (see Table 2-1). Sampler operation is simple

because it has only one moving part (the core tube rotates 180 degrees). Moreover, the sampler does not require disassembly to extrude the samples and reassembly after each sampling attempt. The sampler requires no support equipment other than two sawhorses for supporting the sampler during sample extrusion, a slide-hammer mechanism, and a safe sampling platform.

During the demonstration, minimal strength and stamina were required to collect samples from shallow and moderate depth intervals containing both unconsolidated and consolidated sediments. Specifically, minimal strength and stamina were required to drive the sampler into and retrieve it from the 0- to 4-inch bss depth intervals in S1A1, S1A2, and S2A1 and the moderate depth intervals ranging from 4 to 12 (S2A2), 6 to 12 (S1A1), 10 to 30 (S2A1), and 12 to 32 (S1A2) inches bss. However, moderate to significant strength and stamina were required to collect samples from deep sampling intervals containing highly consolidated sediment. Specifically, moderate to significant strength and stamina were required to drive the sampler into and retrieve it from the 4- to 6-foot bss depth interval in S1A1 and the 9- to 11-foot bss depth interval in S2A2 using the 10-lb ARI slide-hammer mechanism. Moderate to significant strength was also required to rotate the core tube 180 degrees clockwise in order to cut through the consolidated sediment in these depth intervals. Sediment in the 4- to 6-foot bss depth interval was predominantly clay with low water content, and sediment in the 9- to 11-foot bss depth interval was predominantly silty loam with peat and low water content. These consolidated intervals required an increased amount of torque to rotate the core tube.

Previous sediment sampling experience would be beneficial in selecting the most appropriate Russian Peat Borer model for a given application. Model A (with its 2-inch-inside diameter, 20-inch-long core tube) encounters the least resistance during sampler deployment and retrieval through the sediment because of its short length and small turning radius. As a result, this model was used to collect samples in the 4- to 6- (S1A1) and 9- to 11- (S2A2) foot bss depth intervals, where the degree of sediment compaction was high. Model B (with its 2-inch-inside diameter, 40-inch-long core tube) was selected to collect sediment in the shallow and moderate depth intervals in S1A2 and S2A1 because of its greater length and ability to collect sediment in both intervals in one

attempt. Model C (with its 3-inch-inside diameter, 25-inch-long core tube) was used to collect sediment in situations requiring larger sample volume because of its larger core tube diameter. Regardless of the sampler model used, previous sediment sampling experience is also beneficial for accurately assessing sediment surface using the sampler and for positioning the sampler in such a way that sample material is not lost during retrieval.

### **6.2.2 Ability to Collect Samples Under a Variety of Site Conditions**

The Russian Peat Borer demonstrated its ability to collect sediment samples under all conditions encountered during the demonstration, which included a variety of sampling platforms, water depths, sediment depths, and sediment compositions. To operate the sampler, the only primary support facility required is a safe sampling platform. During the demonstration, the range of sampling platforms used included wooden planks fastened to ladders in S2A2; an 18-foot-long, 4-foot-wide Jon boat in S1A2; a sturdier 30-foot-long, 8-foot-wide pontoon boat in S2A1; and the EPA GLNPO *Mudpuppy* in S1A1. Because the sampler does not require electricity or a tripod-mounted winch for deployment, sampler operation was feasible from any location on the sampling platforms used.

Because of the lightness of the sampler and extension rods, water depth had no significant impact on the sampling technician's ability to deploy and retrieve the sampler. Sampling location water depths encountered during the demonstration ranged from about 0.5 foot in S2A2 to about 18 feet in S2A1. As with all sediment samplers, the ability to assess the sediment surface with the Russian Peat Borer diminished with increasing water depth and turbidity. Because of the water depth and turbidity in S1A1, S1A2, and S2A1, the sampling technician could not see the sediment surfaces from the sampling platforms. An underwater video camera may have enabled the sampling technician to accurately assess the location of the sediment surfaces in these areas (Blomqvist 1991).

The sampler was able to collect sediment samples in all shallow and moderate depth intervals (up to 36 inches bss) in each demonstration area. However, during a few attempts in S2A2, partially decomposed cattails and leaves became caught between the core tube and cover plate, causing the core tube to remain in the open position during

sampler retrieval and resulting in washout of the unconsolidated surficial sediment. Similarly, a small stone prevented complete core tube closure and caused partial washout of unconsolidated sediment during 1 of 39 attempts in S2A1. In addition, to sample the unconsolidated sediment in the 0- to 4-inch bss depth interval in S2A1, the sampling technician had to drive the sampler beyond the 0- to 4-inch bss depth interval into layers of sediment that offered enough resistance (support) to hold the cover plate stationary, thus allowing rotation of the core tube. The unconsolidated surficial sediment did not offer adequate resistance.

The sampler also demonstrated its ability to collect sediment samples from deep intervals (greater than 4 feet bss). In S1A1, the sampler successfully collected sediment in the 4- to 6-foot bss depth interval during each attempt at all sampling locations. Because of the degree of sediment compaction in this area, the sampling technician used a 10-lb slide-hammer mechanism to drive the sampler into the target depth interval. As discussed in Section 6.1.1.2, 12 attempts were made to collect the specified volume of sediment, whereas only 5 were expected. The additional attempts were required because (1) in one attempt, the core tube was not fully rotated to the closed position and (2) in the remaining attempts, the sampler had difficulties in penetrating the entire target depth interval, which contained clay hardpan.

In S2A2, the sampler collected sediment in the 9- to 11-foot bss depth interval at three of the five designated locations. Because of the degree of sediment compaction in this area, the sampling technician used a 10-lb slide-hammer mechanism to drive the sampler into the target depth interval. Given the significant effort required to drive and retrieve the sampler using the slide-hammer mechanism, ARI chose not to complete sampling at the remaining two locations. At the locations sampled, the sampler could not be hammered down to the 9- to 11-foot bss depth interval in one attempt. As a result, ARI needed multiple sampling attempts to bore a hole down to the 9- to 11-foot bss depth interval. The depth of sampler deployment achieved during the first attempts ranged from about 3 to 4.5 feet bss. Four to six additional attempts were needed to hammer the sampler into the 9- to 11-foot bss depth interval.

### ***6.2.3 Ability to Collect an Undisturbed Sample***

Based on visual observations, the Russian Peat Borer consistently collected relatively uncompressed, discrete cores of sediment in all depth intervals up to 11 feet bss. In addition, the Russian Peat Borer collected sediment samples containing shells and biological deposits in S1A1 and live biota such as earthworms in S2A2. Sediment stratification for consolidated sediment deposits was also preserved in all samples collected. In general, the Russian Peat Borer demonstrated a unique ability to collect relatively uncompressed and representative core samples of consolidated sediments. However, as discussed above, partially decomposed cattails, leaves, and a small stone prevented complete closure of the core tube during a few attempts in S2A1 and S2A2, resulting in partial washout of unconsolidated surficial sediment. In addition, layering of unconsolidated surficial sediment was not typically preserved after the sampler was retrieved from the water and positioned horizontally for sample extrusion. Specifically, laying the sampler in a horizontal position caused unconsolidated surficial sediment (generally in the 0- to 4-inch bss depth interval) to smear laterally away from the consolidated core segment, thus disturbing the sediment stratification.

### ***6.2.4 Durability Based on Materials of Construction and Engineering Design***

The primary components of the Russian Peat Borer include a stainless-steel core tube and a Delrin<sup>®</sup> core head and bottom point that support a stainless-steel cover plate, which freely rotates in the core tube (see Figure 2-1). The core tube is hinged to the cover plate by two stainless-steel pivot pins at the top and bottom of the plate. Based on observations made during the demonstration, the Russian Peat Borer is a sturdy sampler; none of the Delrin<sup>®</sup> or stainless-steel components of the sampler was damaged or required repair or replacement during the demonstration. However, occasional filing of the edge of the internal wall of the core tube was necessary to maintain the sharp cutting edge and thus minimize disturbance of the sediment. Delrin<sup>®</sup>, a thermoplastic polymer, is self-lubricating and has a high modulus of elasticity as well as strength, stiffness, and resistance to abrasion and moisture. Earlier sediment samplers with a similar design were



typically made entirely of stainless steel, which according to the developer of Delrin<sup>®</sup>, DuPont, would offer greater hardness and abrasion resistance than Delrin<sup>®</sup> over the life of the sampler. However, according to DuPont, Delrin<sup>®</sup> offers a cheaper, lightweight alternative to a sampler with entirely stainless-steel components (Tetra Tech 1999b).

The Russian Peat Borer is also equipped with aluminum extension rods of varying lengths for collection of sediment samples. The extension rods are light in weight and designed to float in water. Each 40-inch-long, 1-inch-diameter extension rod is equipped with a threaded, stainless-steel, male coupling nut riveted to one end of the rod and a threaded, polyethylene, female receptor riveted to the other. During the demonstration, no bending or bowing of the extension rods was observed, even when the rods were coupled together to a total length of about 21 feet for sampling in S2A1. The rigidity of the extension rods is largely due to their relatively large diameter to length ratio. However, compared to the body of the sampler, the extension rods did not exhibit the same degree of durability. In S2A2, the sampling technician noticed a few rivets gradually coming loose from an extension rod during successive attempts to retrieve sediment from the 9- to 11- foot bss depth interval. The damage observed was caused by excessive shear force from the 10-lb slide-hammer mechanism used to drive the sampler to the desired depth and the torque required to rotate the core tube 180 degrees through highly consolidated, stiff peat at a depth of 9 to 11 feet bss. ARI chose to replace the damaged extension rod with a spare one available on site. These observations indicate that the extension rods may require repair or replacement during extended use in highly consolidated sediment.

#### **6.2.5 Availability of Sampler and Spare Parts**

As discussed above, no Russian Peat Borer component or support equipment required off-site replacement or servicing during the demonstration; therefore, secondary objective S5 could not be addressed in the field. Had the sampler or its support equipment required replacement, the replacement would not have been available in local retail stores. Replacement parts may be obtained from ARI by overnight courier in 2 days or less, depending on the location of the sampling site.

## **6.3 Data Quality**

The overall QA objective for the demonstration was to produce well-documented data of known quality. The TSAs conducted to evaluate data quality did not reveal any problems that would make the demonstration data unusable. The scope of these TSAs is described in Sections 4.3 and 4.4 of this ITVR.

This section briefly discusses the data quality of demonstration results for the Russian Peat Borer; more detailed information is provided in the DER (Tetra Tech 1999c). Specifically, the data quality associated with the field measurement activities is discussed first, followed by the data quality associated with the laboratory analysis activities.

### **6.3.1 Field Measurement Activities**

Field measurement activities conducted during the demonstration included measurement of the time associated with sample collection activities, water velocity, water depth, core length, volume of IDW, volume of sediment collected in a given sampling attempt, and depth of sampler deployment. Of these measurement parameters, specific acceptance criteria were set for the precision associated with the time and water velocity measurements only (EPA 1999). All time and water velocity measurements made during the demonstration met their respective criteria (see Table 6-7). Of the remaining parameters, some difficulties were encountered in measuring the volume of sediment collected in a given sampling attempt and the depth of sampler deployment, which are discussed below.

To measure the volume of sediment collected in a given sampling attempt, the sediment sample was transferred into a 2-L container graduated in increments of 20 mL. The container was tapped on a hard surface to minimize the presence of void spaces in the sample, the sample surface was made even using a spoon, and the volume of the sample was measured. However, because the void spaces could not be completely eliminated, the volumetric measurements are believed to have a positive bias that resulted in overestimation of PSRs. Because the total volume of the void spaces could not be measured, its

impact on the PSR results could not be quantified. However, because the same volumetric measurement procedure was used for both the innovative and reference samplers, the PSR results could still be compared.

The depth of sampler deployment was measured with reference to the sediment surface. To identify the location of the sediment surface, the sampling technician lowered the sampler into the water and used the bottom end of the sampler to feel the sediment surface. Subsequently, the technician drove the sampler into the sediment to a depth that he estimated to be appropriate to collect a sediment sample in the specified depth interval. Overall during the demonstration, this approach resulted in actual core lengths that were up to 6 inches greater than the estimated depth of sampler deployment, indicating that the sampling technician may have had some difficulty assessing the location of the sediment surface. Because the Russian Peat Borer is a side-filling sampler that collects a relatively uncompressed sediment sample, the error in assessing the location of the sediment surface should have minimal effect on the core length results. However, the reference samplers used in the demonstration are end-filling samplers that do not have the advantage of collecting uncompressed sediment samples. Therefore, conclusions drawn from a comparison of the sediment characteristics of the samples collected by the reference samplers with those of the samples collected by the Russian Peat Borer should be carefully interpreted.

### **6.3.2 Laboratory Analysis Activities**

The laboratory analyses conducted for the demonstration included the following: (1) PCB, arsenic, and PSD analyses of sediment samples and (2) PCB and arsenic analyses of equipment rinsate samples. To evaluate the data quality of the laboratory analysis results, field-generated QC samples, PE samples, and laboratory QC check samples were analyzed. The field-generated QC samples included the field replicates and temperature blanks described in Section 4.3 of this ITVR. The PE samples and laboratory QC check samples are described in Section 4.4. The acceptance criteria for the QC samples are presented in Table 6-7.

All temperature blanks and field replicates subjected to PCB and arsenic analyses met the acceptance criteria, indicating that the sample homogenization procedure (field replicates) and sample preservation procedure

(temperature blanks) implemented in the field met the demonstration requirements. However, as stated in Section 6.1.3, in a few cases the results of field triplicate sample analyses for PSD did not meet the acceptance criterion. Despite the failures to meet the acceptance criterion, the PSD results are considered to be valid for the reasons detailed in Section 6.1.3.

The PE sample results for both the PCB and arsenic analyses met the acceptance criteria, indicating that the analytical laboratory accurately measured both PCBs and arsenic.

The analytical results for all laboratory QC check samples except the following met the acceptance criteria: (1) MS/MSD samples for analysis for PCBs in the sediment matrix and (2) equipment rinsate samples for PCB analysis. These issues and their likely impact on data quality are discussed below.

For the sediment matrix, in all MS/MSD samples analyzed for PCBs, Aroclor 1016 was recovered at levels higher than the upper limit of the acceptance criterion, indicating a positive bias in PCB results for sediment samples. However, the analytical laboratory had no problem meeting the acceptance criteria for control samples such as BS/BSDs. For this reason, the failure to meet the acceptance criterion for MS/MSD sample analysis was attributed to matrix interference. Because Aroclor 1016 was recovered at levels higher than the upper limit of the acceptance criterion in all MS/MSD samples associated with both the innovative and reference samplers, the PCB results could still be compared.

In all equipment rinsate samples analyzed for PCBs, decachlorobiphenyl (the surrogate) was recovered at levels lower than the lower limit of the acceptance criterion, indicating a negative bias in the PCB results for equipment rinsate samples. However, the analytical laboratory had no problem meeting the acceptance criteria for control samples such as PE samples and deionized water blanks. For this reason, the failure to meet the surrogate recovery acceptance criterion for equipment rinsate sample analysis was attributed to matrix interference. Because the surrogate was recovered at levels lower than the lower limit of the acceptance criterion in all equipment rinsate samples associated with both the innovative and reference samplers, the PCB results could still be compared.



**Table 6-7. Summary of Quality Control Checks and Acceptance Criteria for Field and Laboratory Parameters**

Parameter	Quality Control Check	Matrix	Acceptance Criterion
<b>Field</b>			
Time required for sample collection activities	Simultaneous measurements	Not applicable	RPD ≤ 10
Water velocity	Consecutive measurements	Water	RPD ≤ 20
Cooler temperature	Temperature blank	Water	4 ± 2 °C
<b>Laboratory</b>			
PCBs	Method blank	Sediment and equipment rinsate	≤ Reporting limit
	Surrogate	Sediment and equipment rinsate	Percent recovery: 50 to 160
	MS/MSD	Sediment	RPD ≤ 23 Percent recovery: 65 to 130 (Aroclor 1016) Percent recovery: 66 to 128 (Aroclor 1260)
	Extract duplicates	Sediment	RPD ≤ 20
		Equipment rinsate	RPD ≤ 10
	BS/BSD	Sediment	RPD ≤ 23 Percent recovery: 65 to 130 (Aroclor 1016) Percent recovery: 66 to 128 (Aroclor 1260)
		Equipment rinsate	RPD ≤ 20 Percent recovery: 73 to 123 (Aroclor 1016) Percent recovery: 77 to 120 (Aroclor 1260)
	Field triplicates	Sediment	RSD ≤ 50
	Field duplicates	Equipment rinsate	RPD ≤ 20
	PE samples	Soil	87.9 to 238 parts per billion for Aroclor 1242 (certified value: 197 parts per billion)  900 to 2,400 parts per billion for Aroclor 1242 (certified value: 2,020 parts per billion)
Water		2.27 to 5.33 parts per billion for Aroclor 1248 (certified value: 4.26 parts per billion)	
Arsenic	Interference check solution A	Sediment and equipment rinsate	± 2 times reporting limit
	Interference check solution AB	Sediment and equipment rinsate	Percent recovery: 80 to 120
	Serial dilution	Sediment and equipment rinsate	± 10 percent of the original determination for samples with concentrations > 50 times the instrument detection limit
	Method blank	Sediment and equipment rinsate	≤ Reporting limit
	MS/MSD	Sediment	RPD ≤ 10 Percent recovery: 67 to 109
	Postdigestion spike	Sediment and equipment rinsate	Percent recovery: 75 to 125
	Digestate duplicates	Sediment and equipment rinsate	RPD ≤ 10
	BS/BSD	Sediment	RPD ≤ 10 Percent recovery: 80 to 120
		Equipment rinsate	RPD ≤ 10 Percent recovery: 81 to 113
	Field triplicates	Sediment	RSD ≤ 30
Field duplicates	Equipment rinsate	RPD ≤ 20	

**Table 6-7. Summary of Quality Control Checks and Acceptance Criteria for Field and Laboratory Parameters (Continued)**

Parameter	Quality Control Check	Matrix	Acceptance Criterion
<b>Laboratory (Continued)</b>			
Arsenic (continued)	PE samples	Soil	Actual concentration = 239 mg/kg Expected recovery <sup>a</sup> = 199 mg/kg Actual recovery <sup>b</sup> = 183 mg/kg  Actual concentration = 6.02 mg/kg Expected recovery <sup>a</sup> = 5 mg/kg Actual recovery <sup>b</sup> = 4.81 mg/kg
		Water	25.0 to 39.4 parts per billion (certified value: 33.4 parts per billion)
PSD	Repeat analysis	Sediment	± 1 hydrometer unit
	Field triplicates	Sediment	RPD ≤ 15 for sand, silt, and clay

Notes:

- |        |   |                                     |     |   |                             |
|--------|---|-------------------------------------|-----|---|-----------------------------|
| >      | = | Greater than                        | PCB | = | Polychlorinated biphenyl    |
| ≤      | = | Less than or equal to               | PE  | = | Performance evaluation      |
| ±      | = | Plus or minus                       | PSD | = | Particle size distribution  |
| BS/BSD | = | Blank spike/blank spike duplicate   | RPD | = | Relative percent difference |
| mg/kg  | = | Milligram per kilogram              | RSD | = | Relative standard deviation |
| MS/MSD | = | Matrix spike/matrix spike duplicate |     |   |                             |

<sup>a</sup> The expected recovery is based on typical recoveries of arsenic in soil during multiple interlaboratory studies.

<sup>b</sup> The actual recovery is the mean arsenic concentration in the PE sample based on four replicate analyses by the proficiency testing laboratory.

---

## Chapter 7

### Performance of the Reference Samplers

To verify a wide range of performance attributes, the innovative sediment sampler demonstration had both primary and secondary objectives. Primary objectives were critical to the technology evaluation and were intended to produce quantitative results regarding technology performance. Secondary objectives provided information that was useful but did not necessarily produce quantitative results regarding technology performance. The approach used to address each primary and secondary objective for the Russian Peat Borer and reference samplers is discussed in Chapter 4. This chapter describes the performance of the reference samplers based on the primary objectives (excluding costs associated with sample collection activities) and secondary objectives. This chapter also discusses the data quality of demonstration results for the reference samplers.

The performance of the Russian Peat Borer is discussed in Chapter 6, costs associated with sample collection activities (primary objective P7) are presented in Chapter 8, and the performance of the Russian Peat Borer and reference samplers is compared in summary form in Chapter 9.

#### 7.1 Primary Objectives

This section discusses the performance results for the reference samplers based on the primary objectives stated in Section 4.1 except for primary objectives P4 and P7, which are addressed in Section 6.1.4 and Chapter 8, respectively. Otherwise, the primary objectives discussed in this section are the same as those discussed in Section 6.1. During the demonstration, the sampling technicians were provided an opportunity to practice sample collection at each demonstration area until they felt confident enough to initiate demonstration sampling.

To address primary objectives, samples were collected using two different reference samplers, the Vibrocorer in S1A1 and the Hand Corer in the other areas. The areas and depth intervals sampled are the same as those described in Section 6.1 except that the 4- to 6-foot bss and 9- to 11-foot bss depth intervals in S1A1 and S2A2, respectively, were not sampled using the reference samplers. The Vibrocorer had difficulty fully penetrating the 4- to 6-foot bss depth interval because of the presence of clay hardpan and was thus unable to collect samples from this interval in S1A1; the sampling technicians made only a few attempts and decided not to complete sampling in this depth interval. In S2A2, the Hand Corer was not used for the 9- to 11-foot bss depth interval because it is not designed to collect samples at depths below 3 feet bss. Consequently, the reference samplers were not evaluated with respect to these two depth intervals. The numbers of investigative and QC samples collected in each area, sediment sample volumes required, and sample analytical parameters are discussed in Chapter 4.

The demonstration results for the reference samplers under primary objectives P1 and P2 were evaluated using the Wilk-Shapiro test to determine whether the results were normally distributed. Because most of the results were not normally distributed, the Wilk-Shapiro test was used in an attempt to evaluate whether the results followed a lognormal distribution. The test revealed that the results either were not lognormally distributed or could not be tested for lognormality because they contained values that were equal to zero. For these reasons, the Student's t-test, a parametric test, was not used to perform hypothesis testing; the Wilcoxon signed rank test, a nonparametric test, was used as an alternative to the Student's t-test. As described in Section 6.1, Statistix<sup>®</sup> was used to perform statistical evaluations of the demonstration results

(Analytical Software 1996). Appendix C provides details on the statistical methods used for data evaluation.

### 7.1.1 Ability to Consistently Collect a Specified Volume of Sediment

Primary objective P1 involved evaluating the reference samplers' ability to consistently collect a specified volume of sediment. This objective was addressed by comparing (1) the actual number of sampling attempts required to collect a specified volume of sediment to the expected number of attempts (rounded to the nearest higher integer) at each sampling location in each target depth interval and (2) the actual volume of sediment collected in the specified target depth interval in each attempt to the calculated sampler volume (design volume) for the depth interval. The expected number of attempts was determined by dividing the specified sample volume by the design volume for the depth interval. The results of these comparisons are summarized below.

#### 7.1.1.1 Number of Sampling Attempts Required

Tables 7-1 and 7-2 present the expected and actual number of reference sampler sampling attempts for each depth interval at Sites 1 and 2, respectively. Initially, the Wilcoxon signed rank test was used to determine whether the difference between the expected and actual number of attempts was statistically significant. However, the conclusions drawn from the Wilcoxon signed rank test were inconsistent with the conclusions reached in comparing the expected and actual number of attempts (see Appendix C for an example).

In S1A1, the Vibrocorer performed well in the 0- to 4- and 6- to 12-inch bss depth intervals, where the expected number of attempts equaled the actual number of attempts. As stated above, the Vibrocorer had difficulty fully penetrating the 4- to 6-foot bss depth interval because of the presence of clay hardpan and was thus unable to collect samples from this interval in S1A1; the sampling technicians made a few attempts and decided not to complete sampling in this depth interval.

In S1A2, the Hand Corer performed well in the 0- to 4-inch bss depth interval, where the expected number of attempts equaled the actual number of attempts, but did not perform as well in the 12- to 32-inch bss depth interval. In the 12- to 32-inch bss depth interval, the Hand Corer required three additional attempts. The additional attempts in this depth interval may be attributable to (1) error in assessing the location of the sediment surface, which might have resulted in the actual depth of penetration being less than the measured depth of penetration; (2) deficient entry of sediment into the core tube (core shortening); (3) the sediment consisting of high levels of silt (63 to 72 percent) and clay (22 to 31 percent), which might have caused plug formation in the coring tip that inhibited further sediment retrieval; or (4) sediment loss during sampler retrieval.

In S2A1, the Hand Corer again performed better in the shallower of the two depth intervals sampled. In the 0- to 4-inch bss depth interval, the Hand Corer required 39 attempts, whereas 33 attempts were expected. In the 10- to 30-inch bss depth interval, the Hand Corer required more than three times the expected number of attempts to collect adequate sample volumes, and the actual number

**Table 7-1. Comparison of Expected and Actual Number of Sampling Attempts for Reference Samplers at Site 1**

Location	Number of Attempts in S1A1 (River Mouth) Using Vibrocorer				Number of Attempts in S1A2 (Freshwater Bay) Using Hand Corer			
	0- to 4-Inch bss Depth Interval		6- to 12-Inch bss Depth Interval		0- to 4-Inch bss Depth Interval		12- to 32-Inch bss Depth Interval	
	Expected	Actual	Expected	Actual	Expected	Actual	Expected	Actual
1A	1	1	1	1	1	1	1	1
1E	1	1	1	1	1	1	1	2
3C	1	1	1	1	1	1	1	3
5A	1	1	1	1	1	1	1	1
5E	1	1	1	1	1	1	1	1
Total	5	5	5	5	5	5	5	8

Note:

bss = Below sediment surface

**Table 7-2. Comparison of Expected and Actual Number of Sampling Attempts for Reference Sampler at Site 2**

Number of Attempts in S2A1 (Lake) Using Hand Corer					Number of Attempts in S2A2 (Wetland) Using Hand Corer		
Location	0- to 4-Inch bss Depth Interval		10- to 30-Inch bss Depth Interval		Location	4- to 12-Inch bss Depth Interval	
	Expected	Actual	Expected	Actual		Expected	Actual
1A	3	3	1	4	1A	1	2
1B	4	4	1	5	1E	1	12 <sup>a</sup>
1E	3	4	1	3	3C	1	3
2A	2	2	1	2	5A	1	2
2C	5	7	1	3	5E	1	1
2D	2	2	1	1	<b>Total</b>	<b>5</b>	<b>20</b>
2E	2	2	1	2			
3A	5	7	1	6			
3B	4	5	1	3			
3E	3	3	1	2			
<b>Total</b>	<b>33</b>	<b>39</b>	<b>10</b>	<b>31</b>			

Notes:

bss = Below sediment surface

<sup>a</sup> Sampling was discontinued after the 12 attempts made at this location failed to collect the specified sediment volume.

of attempts equaled the expected number of attempts at only one of the ten sampling locations. The sampler failures in S2A1 may be attributable to the reasons cited above for S1A2 except that in S2A1, the sediment does not consist of as much clay as does the sediment in S1A2 and thus exhibited less tendency for plug formation in the coring tip. Also, during sampler retrieval in S2A1, the sampler's flutter valve did not seat properly in a few attempts. This malfunction resulted in partial or complete loss of vacuum in the core tube and subsequent sample loss.

In the 4- to 12-inch bss depth interval in S2A2, the Hand Corer had significant difficulty in collecting sediment; 20 attempts were recorded, whereas 5 were expected. Of the 20 attempts, more than half (12) were recorded at Location 1E. Eight attempts were recorded at the remaining four locations, whereas four were expected. Moreover, more than 20 attempts would have been necessary to complete sampling in this depth interval because sampling was discontinued at Location 1E after the 12 attempts made at this location failed to collect the specified sediment volume. The Hand Corer experienced the greatest number of problems in S2A2, perhaps because

this area contained significant amounts of partially decomposed reeds and leaves and live vegetation. As a result, the sediment matrix was highly heterogenous and was difficult to cut through, capture, and retain. The sampler failures in S2A2 may also be attributed to the reasons cited above for S1A2.

In summary, the demonstration results indicate that the Vibrocorer demonstrated the ability to consistently collect a specified volume of sediment in the 0- to 4- and 6- to 12-inch bss depth intervals because the number of actual attempts equaled the number of expected attempts. However, the Vibrocorer did not collect samples in the 4- to 6-foot bss depth interval. The Hand Corer collected surficial sediment well but had difficulty collecting samples at depths greater than 4 inches bss. In the two 0- to 4-inch bss depth intervals, the Hand Corer required only 16 percent more attempts than expected (44 actual attempts versus 38 expected attempts). In contrast, in the deeper intervals, the Hand Corer required nearly 200 percent more attempts than expected (59 actual attempts versus 20 expected attempts), indicating a high level of inconsistency in collecting specified volumes of sediment.

### 7.1.1.2 Volume of Sediment Collected

The volume of sediment collected by the reference samplers in each sampling attempt in a given depth interval was divided by the corresponding design volume, and the resulting ratio was multiplied by 100 to estimate the PSR. The RSD of the PSRs was calculated to evaluate the ability of the reference samplers to consistently collect a specified volume of sediment; if a sampler were to recover an identical volume of sediment in every attempt, the RSD would equal zero. Both PSR and RSD results should be considered to properly evaluate the sampler's performance because a low RSD, which indicates that the sampler's performance was consistent, may be based on

consistently low PSRs. Figures 7-1 and 7-2 present PSRs for the reference samplers at Sites 1 and 2, respectively. Table 7-3 presents PSR summary statistics (range, mean, and RSD) for both sites.

The Vibrocorer performed well in the 0- to 4- and 6- to 12-inch bss depth intervals in S1A1. Each attempt in the 0- to 4-inch bss depth interval had a PSR of 100. In the 6- to 12-inch bss depth interval, a narrow PSR range of 79 to 83 resulted in an RSD of 3 percent, which is less than the 30 percent RSD guideline. Although the Vibrocorer collected a consistent volume of sediment in this depth interval, it did not collect more than 83 percent of its design volume.

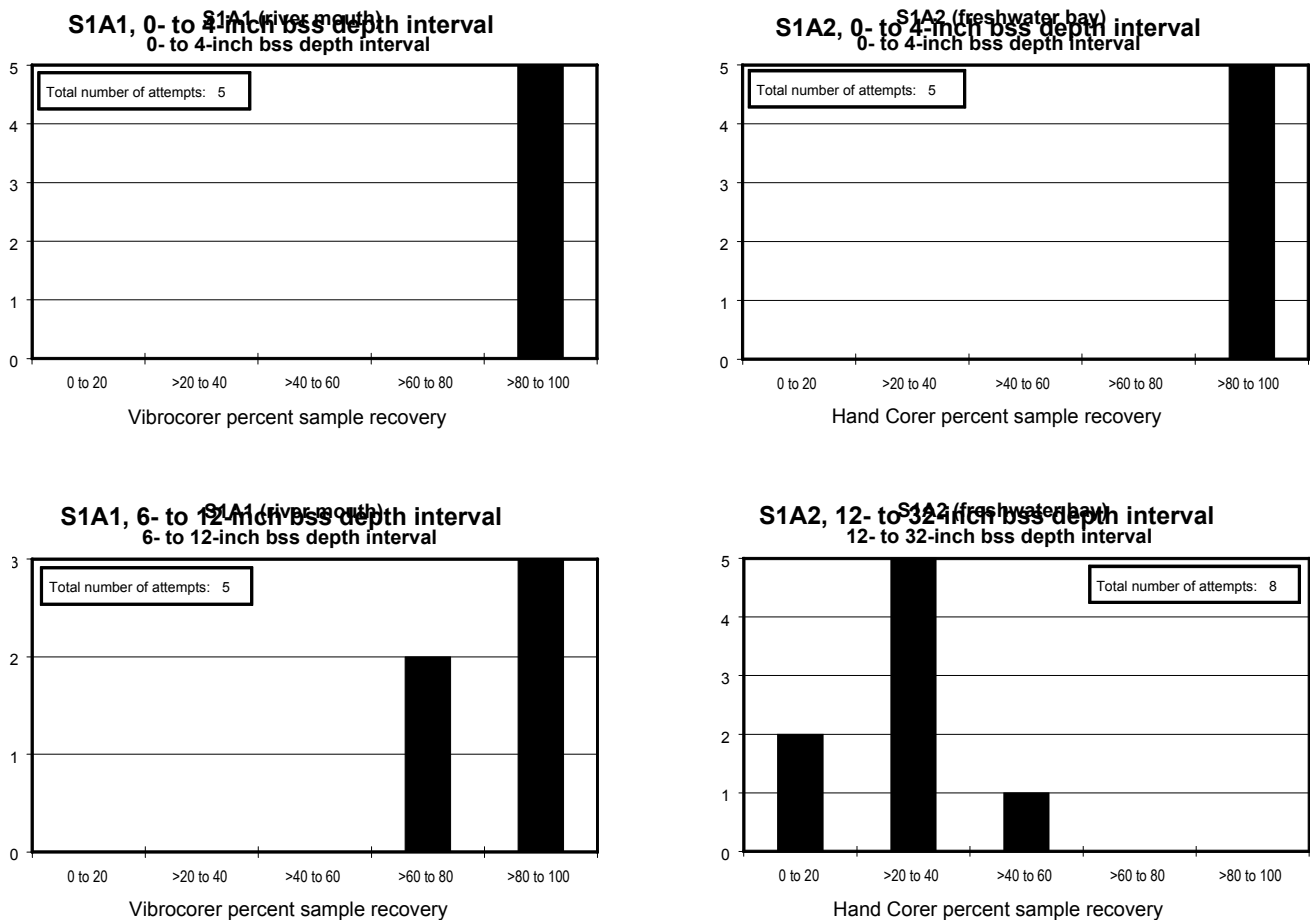

Note:

bss = Below sediment surface

Figure 7-1. Percent sample recoveries for Vibrocorer and Hand Corer at Site 1.



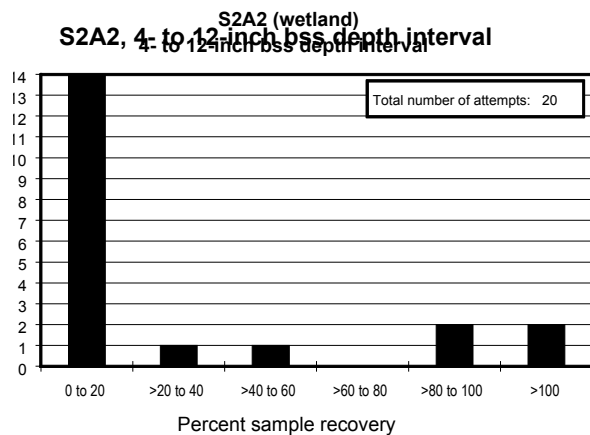
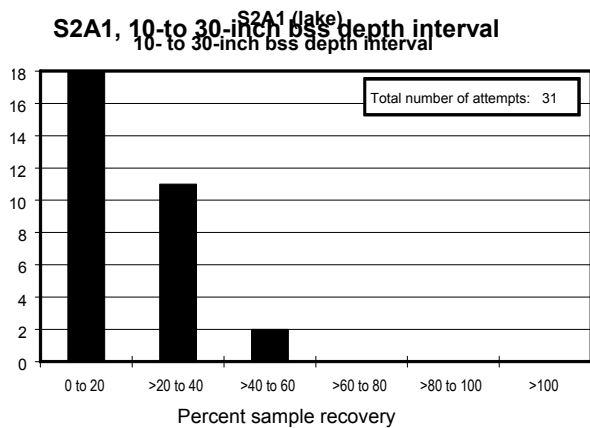
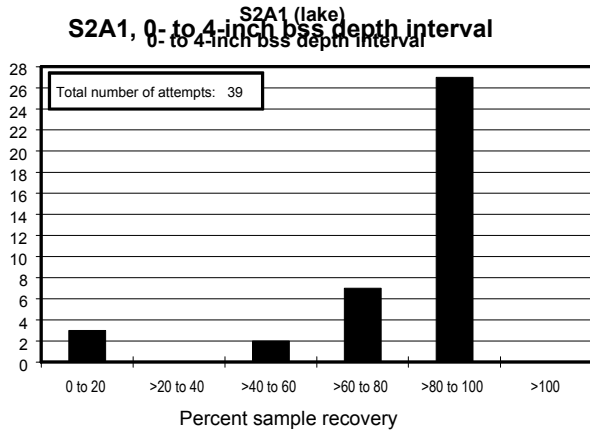

Notes:

bss = Below sediment surface

Percent sample recoveries exceeding 100 resulted from the volumetric measurement error associated with the presence of void spaces when the sediment was transferred to a graduated container.

In S1A2, the Hand Corer performed well in the 0- to 4-inch bss depth interval but performed poorly in the 12- to 32-inch bss depth interval. In the 0- to 4-inch bss depth interval, the Hand Corer achieved a PSR of 100 in every attempt. However, in the 12- to 32-inch bss depth interval, PSRs ranged from 15 to 55 and had a mean of only 31, as shown in Table 7-3. As shown in Figure 7-1, five of the eight attempts in this interval fell in the greater than 20 to 40 percent range, and two of the eight attempts fell in the 0 to 20 percent range. Because the recoveries fell in a narrow range, the RSD of 35 percent exceeded the RSD guideline of 30 percent by only 5 percentage points.

In S2A1, the Hand Corer performed well in the 0- to 4-inch bss depth interval but did not perform well in the 10- to 30-inch bss depth interval. As shown in Table 7-3, PSRs for the 0- to 4-inch bss depth interval ranged from 0 to 100 with a mean of 85. As shown in Figure 7-2, 27 of the 39 attempts in this interval had PSRs of 80 to 100, and 34 of the 39 attempts had PSRs greater than 60. Because most of the PSRs fell in a narrow range, the RSD of 33 percent compared favorably to the 30 percent RSD guideline. In the 10- to 30-inch bss depth interval, the PSRs ranged from 0 to 50 with a mean of 21. As shown in Figure 7-2, most of the PSRs fell in the 0 to 20 range. An RSD of 62 percent was calculated for the 10- to 30-inch bss depth interval, which indicates a high degree of inconsistency.

In the 4- to 12-inch bss depth interval in S2A2, the Hand Corer had difficulty collecting sediment. As shown in Table 7-3, PSRs for S2A2 ranged from 0 to 125 with a mean of 22. This wide range of PSRs resulted in an extremely high RSD of 161 percent. Figure 7-2 shows that 70 percent of the attempts fell in the 0 to 20 PSR range, which indicates consistently low recoveries.

In summary, the Vibrocorer performed well in the 0- to 4- and 6- to 12-inch bss depth intervals, and the Hand Corer performed well in the shallow depth intervals but not in the deeper intervals. In the 0- to 4- and 6- to 12-inch bss depth intervals in S1A1, the Vibrocorer had RSDs that were less than the 30 percent RSD guideline. The Hand Corer performed well in the 0- to 4-inch bss depth intervals, in S1A2 and S2A1 for which low RSDs (0 and 33 percent, respectively) were observed. In the 10- to 30- and 4- to 12-inch bss depth intervals in S2A1 and S2A2, the RSDs of 62 and 161 percent, respectively, were well above the 30 percent RSD guideline.

Figure 7-2. Percent sample recoveries for Hand Corer at Site 2.

**Table 7-3. Percent Sample Recovery Summary Statistics for Reference Samplers**

Demonstration Area	Reference Sampler	Target Depth Interval (inches bss)	Actual Number of Attempts	PSR Range <sup>a</sup>	Mean PSR	RSD (%)
S1A1 (river mouth)	Vibrocorer	0 to 4	5	100	100	0
		6 to 12	5	79 to 83	82	3
S1A2 (freshwater bay)	Hand Corer	0 to 4	5	100	100	0
		12 to 32	8	15 to 55	31	35
S2A1 (lake)	Hand Corer	0 to 4	39	0 to 100	85	33
		10 to 30	31	0 to 50	21	62
S2A2 (wetland)	Hand Corer	4 to 12	20 <sup>b</sup>	0 to 125	22	161

Notes:

- bss = Below sediment surface
- PSR = Percent sample recovery
- RSD = Relative standard deviation

<sup>a</sup> PSRs exceeding 100 resulted from the volumetric measurement error associated with the presence of void spaces when the sediment was transferred to a graduated container.

<sup>b</sup> More than 20 attempts would have been necessary to complete sampling in this depth interval because sampling was discontinued at Location 1E after the 12 attempts made at this location failed to collect the specified sediment volume.

**7.1.2 Ability to Consistently Collect Sediment in a Specified Depth Interval**

Primary objective P2 involved evaluating the reference samplers’ ability to consistently collect sediment in a specified depth interval. This objective was addressed by comparing actual and target core lengths for each depth interval. The target core length for a sample was equal to the distance between the upper and lower boundaries of a depth interval. Because the core length measurements presented in this section do not account for void space, an attempt may have achieved an actual core length that equaled the target core length but may not have resulted in a PSR of 100.

Because of difficulties in assessing the location of the sediment surface, the sampling technicians chose to push the samplers beyond the specified depth intervals. Consequently, accuracy in determining a specified depth interval may have been compromised. To assess overall accuracy in determining specified depth intervals, core lengths were compared to depths of sampler deployment; if a core length equals the depth of deployment, one may conclude that the core length accurately reflects the specified depth interval. However, in most cases for the reference samplers, the core lengths were shorter than the depths of deployment, indicating the occurrence of core

shortening or loss of sample during sampler retrieval. Because core shortening plays a significant role in sediment sampling using end-filling samplers and because both reference samplers are end-filling samplers, core shortening is briefly described below.

Core shortening, which primarily involves deficient entry of sediment into the core tube during sampler penetration, occurs because friction between sediment and the inside wall of the sampler gradually increases as the core tube penetrates the sediment, resulting in gradual thinning of the core by lateral extrusion in front of the core tube. As the friction changes with the depth of penetration, the extent of core shortening also changes. Thus, not all sediment layers may be uniformly represented within a given sample, and the actual core length will be less than the depth of sampler deployment (Blomqvist 1991). Core shortening is more likely to affect sampling attempts in deeper intervals than in shallower intervals. Core shortening is expected to be less prevalent for the Vibrocorer, because the vibrations produced by this sampler reduce the friction generated upon sediment entry into the core tube.

Table 7-4 presents the number of attempts in which the actual core length equaled the target core length, target core lengths, and mean actual core lengths. Initially, the

**Table 7-4. Comparison of Target and Actual Core Length Data for Reference Samplers**

Demonstration Area	Reference Sampler	Target Depth Interval (inches bss)	Number of Attempts in Which Actual Core Length Equaled Target Core Length/Total Attempts	Target Core Length (inches)	Mean Actual Core Length (inches)
S1A1 (river mouth)	Vibrocorer	0 to 4	5/5	4	4
		6 to 12	5/5	6	6
S1A2 (freshwater bay)	Hand Corer	0 to 4	5/5	4	4
		12 to 32	0/8	20	7
S2A1 (lake)	Hand Corer	0 to 4	36/39	4	~4 <sup>a</sup>
		10 to 30	0/31	20	5
S2A2 (wetland)	Hand Corer	4 to 12	3/20	8	2

Notes:

bss = Below sediment surface

<sup>a</sup> The calculated mean actual core length (3.7 inches) was rounded to the nearest integer.

Wilcoxon signed rank test was to be used to determine whether differences between the actual and target core lengths were statistically significant. However, review of the Wilcoxon signed rank test results revealed that the results for many of the data sets were inconsistent with the conclusions reached in comparing the target and actual core lengths for the reasons described in Section 6.1. Therefore, primary objective P2 was addressed by evaluating (1) the number of attempts in which the actual core length equaled the target core length and (2) the difference between the target core length and the mean actual core length.

In S1A1, samples collected by the Vibrocorer equaled the target core length in five out of five attempts in both the 0- to 4- and 6- to 12-inch bss depth intervals. However, these results are not surprising because the depth of sampler deployment was at least 52 inches for these attempts. The Vibrocorer had difficulty fully penetrating the 4- to 6-foot bss depth interval in S1A1 because of the presence of clay hardpan and was thus unable to collect samples in this interval; the sampling technicians made a few attempts and then decided not to complete sampling in this interval. The average core length retrieved in this area was about 23 percent shorter than the depth of sampler deployment.

In S1A2, samples collected by the Hand Corer equaled the target core length in all attempts in the 0- to 4-inch bss depth interval but failed to do so in any of the attempts in the 12- to 32-inch bss depth interval. Samples collected in

the latter interval ranged in core length from 3 to 11 inches, with a mean core length of 7 inches. The additional attempts in this interval may be attributable to (1) error in assessing the location of the sediment surface, which might have resulted in the actual depth of penetration being less than the measured depth of penetration; (2) core shortening; (3) the sediment consisting of high levels of silt and clay, resulting in formation of a plug in the coring tip that inhibited further sediment retrieval; or (4) sediment loss during sampler retrieval. The average core length retrieved in this area was about 52 percent shorter than the depth of sampler deployment.

The results observed in S2A1 were similar to those observed in S1A2. In the 0- to 4-inch bss depth interval in S2A1, samples collected by the Hand Corer equaled the target core length in 36 of 39 attempts; consequently, the mean actual core length calculated for this interval (3.7 inches rounded to 4 inches) compared favorably to the target core length of 4 inches. However, none of the samples collected during the 31 attempts in the 10- to 30-inch bss depth interval equaled the target core length. The actual core lengths in this depth interval ranged from 0 to 12 inches, resulting in a mean core length of 5 inches that compared unfavorably to the target core length of 20 inches. The sampler failures in the deeper interval in S2A1 may be attributable to the reasons cited for S1A2 except that in S2A1, the sediment does not consist of as much clay as does the sediment in S1A2 and thus provides less opportunity for plug formation in the coring tip. In

S2A1, during sampler retrieval the sampler's flutter valve did not seat properly in a few attempts. This malfunction resulted in partial or complete loss of vacuum in the core tube and thus sample loss. The average core length retrieved in this area was about 41 percent shorter than the depth of sampler deployment.

In S2A2, only 3 of the 20 core lengths collected by the Hand Corer in the 4- to 12-inch bss depth interval equaled the target core length. The actual core lengths ranged from 0 to 8 inches, with a mean core length of 2 inches that compared poorly to the target core length of 8 inches. As mentioned above, the Hand Corer experienced the greatest number of problems in S2A2, perhaps because this area contained significant amounts of partially decomposed reeds and leaves and live vegetation. As a result, the sediment matrix was heterogenous and was difficult to cut through, capture, and retain. The average core length retrieved in this area was about 78 percent shorter than the depth of sampler deployment.

In summary, the demonstration results indicate that the Vibrocorer was able to consistently collect sediment from the 0- to 4- and 6- to 12-inch bss depth intervals in S1A1 because the core lengths for all attempts in both depth intervals equaled the target core lengths. The Hand Corer collected surficial sediment well but had difficulty collecting samples from depths greater than 4 inches bss. Specifically, samples collected in the 0- to 4-inch bss depth intervals equaled the target core length in 41 of 44 attempts. However, the actual core lengths did not equal the target core length for any of the samples collected in the 12- to 32- and 10- to 30-inch bss depth intervals in S1A2 and S2A1, respectively, and equaled the target core length in only 3 of 20 attempts in the 4- to 12-inch bss depth interval in S2A2.

### ***7.1.3 Ability to Collect Multiple Samples with Consistent Physical or Chemical Characteristics, or Both, from a Homogenous Layer of Sediment***

Primary objective P3 involved evaluating the Hand Corer's ability to collect multiple samples with consistent physical or chemical characteristics, or both, from a homogenous layer of sediment. This objective was addressed by calculating the RSD values for the sample analytical results for the 12- to 32-inch bss depth interval in S1A2, and the 0- to 4- and 10- to 30-inch bss depth

intervals in S2A1. Based on the predemonstration investigation results, these three depth intervals were determined to be homogenous in terms of their physical characteristics, and the two S2A1 depth intervals were determined to be homogenous in terms of their chemical characteristics.

For the Hand Corer samples, Figure 7-3 presents the demonstration analytical results for PSD in the 12- to 32-inch bss depth interval in S1A2, and Figure 7-4 presents the demonstration analytical results for arsenic and PSD in the 0- to 4- and 10- to 30-inch bss depth intervals in S2A1. The demonstration analytical results for arsenic contain statistical outliers that indicate that the two S2A1 depth intervals may not be chemically homogenous. For this evaluation, the outliers are defined as sample analytical results that are not within two standard deviations of the mean; the outliers include the 250 mg/kg of arsenic in the 0- to 4-inch bss depth interval and the 52 mg/kg of arsenic in the 10- to 30-inch bss depth interval in S2A1. Outliers were also found in the analytical results for samples collected by the Russian Peat Borer (see Section 6.1.3), providing further evidence that the two S2A1 depth intervals may not be chemically homogenous. A similar analysis performed for the PSD results revealed no statistical outliers. Therefore, the Hand Corer was evaluated based only on its ability to collect multiple samples with consistent physical characteristics. RSDs were calculated for each depth interval based on the PSD analytical results for all locations sampled.

Table 7-5 presents the PSD summary statistics (range, mean, and RSD) calculated for the samples and field triplicates collected using the Hand Corer in each depth interval relevant to primary objective P3. As stated in Section 6.1.3, RSDs calculated for the PSD results were compared to the laboratory acceptance criterion of 15 percent for field triplicates. When the RSD for all samples from a given depth interval was greater than 15 percent, it was compared to the measured RSD for the field triplicates. An RSD for all samples that is less than the RSD for field triplicates may be more attributable to the laboratory's analytical procedure or the sample homogenization procedure implemented in the field, or both, rather than the sampler's ability to collect physically consistent samples. However, PSD parameters with means less than 10 percent were not evaluated in this manner because at low levels, the analytical method is not as precise; as a result, it will

12- to 32-inch bss depth interval

<b>Location 1A</b> Sand: 6% Silt: 72% Clay: 22%				<b>Location 1E</b> Sand: 6% Silt: 63% Clay: 31%
		<b>Location 3C</b> Sand: 3% Silt: 70% Clay: 27%		
<b>Location 5A</b> Sand: 4% Silt: 68% Clay: 28%				<b>Location 5E</b> Sand: 3% Silt: 67% Clay: 30%

Note:

bss = Below sediment surface

Figure 7-3. Hand Corer sample particle size distribution results for S1A2 (freshwater bay).

generate high RSD values and may not actually reveal whether multiple samples with consistent physical characteristics were collected.

For the 12- to 32-inch bss depth interval in S1A2, the RSDs for silt and clay results were below the 15 percent laboratory acceptance criterion. The mean sand level was less than 10 percent and was not evaluated using the criterion. However, the sand levels exhibited a tight range (3 to 6 percent).

For the 0- to 4-inch bss depth interval in S2A1, the RSD for silt levels (15 percent) met the laboratory acceptance criterion, but the RSD for sand levels (23 percent) did not. Because the RSD for sand levels exceeded the criterion but the RSD for sand levels in the field triplicates (3 percent) met the criterion, some of the variation in the sand results may be attributable to the Hand Corer's ability to collect multiple samples with consistent physical characteristics. The mean clay level in samples collected in the 0- to 4-inch bss depth interval in S2A1 was less than 10 percent and was not evaluated using the criterion.

**0- to 4-inch bss depth interval**

<b>Location 1A</b> Arsenic: 250 mg/kg  Sand: 32% Silt: 63% Clay: 2%	<b>Location 1B</b> Arsenic: 130 mg/kg			<b>Location 1E</b> Arsenic: 190 mg/kg  Sand: 26% Silt: 72% Clay: 2%
<b>Location 2A</b> Arsenic: 190 mg/kg		<b>Location 2C</b> Arsenic: 120 mg/kg  Sand: 46% Silt: 48% Clay: 2%	<b>Location 2D</b> Arsenic: 130 mg/kg	<b>Location 2E</b> Arsenic: 150 mg/kg
<b>Location 3A</b> Arsenic: 140 mg/kg  Sand: 32% Silt: 63% Clay: 5%	<b>Location 3B</b> Arsenic: 140 mg/kg			<b>Location 3E</b> Arsenic: 130 mg/kg  Sand: 29% Silt: 71% Clay: 0%

**10- to 30-inch bss depth interval**

<b>Location 1A</b> Arsenic: 24 mg/kg  Sand: 38% Silt: 61% Clay: 0%	<b>Location 1B</b> Arsenic: 8.5 mg/kg			<b>Location 1E</b> Arsenic: 16 mg/kg  Sand: 35% Silt: 62% Clay: 3%
<b>Location 2A</b> Arsenic: 8.3 mg/kg		<b>Location 2C</b> Arsenic: 9.7 mg/kg  Sand: 43% Silt: 53% Clay: 3%	<b>Location 2D</b> Arsenic: 13 mg/kg	<b>Location 2E</b> Arsenic: 7.2 mg/kg
<b>Location 3A</b> Arsenic: 7.2 mg/kg  Sand: 37% Silt: 58% Clay: 4%	<b>Location 3B</b> Arsenic: 8.2 mg/kg			<b>Location 3E</b> Arsenic: 52 mg/kg  Sand: 35% Silt: 62% Clay: 3%

Notes:

bss = Below sediment surface  
 mg/kg = Milligram per kilogram

The particle size distribution results for a given sample may not total 100 percent because of rounding or because some sediment did not pass through the U.S. Standard No. 4 sieve and was classified as gravel rather than sand, silt, or clay.

**Figure 7-4. Hand Corer sample arsenic and particle size distribution results for S2A1 (lake).**



**Table 7-5. Particle Size Distribution Summary Statistics for Hand Corer**

Demonstration Area	Depth (inches bss)	Parameter	Number of Samples	Range (%)	Mean (%)	RSD (%) (All Samples)	RSD (%) (Field Triplicates)
S1A2 (freshwater bay)	12 to 32	Sand	5	3 to 6	4	34	0
		Silt	5	63 to 72	68	5	3
		Clay	5	22 to 31	28	13	8
S2A1 (lake)	0 to 4	Sand	5	26 to 46	33	23	3
		Silt	5	48 to 72	63	15	6
		Clay	5	0 to 5	2	18	29
	10 to 30	Sand	5	35 to 43	38	9	14
		Silt	5	53 to 62	59	6	2
		Clay	5	0 to 4	3	60	71

Notes:

- bss = Below sediment surface
- RSD = Relative standard deviation

However, the clay levels exhibited a tight range (0 to 5 percent).

For the 10- to 30-inch bss depth interval in S2A1, the RSDs for sand and silt levels were below the 15 percent laboratory acceptance criterion. The mean clay level in samples collected in the depth interval was less than 10 percent and was not evaluated using the criterion. However, the clay levels exhibited a tight range (0 to 4 percent).

In summary, the Hand Corer met the primary objective P3 criteria except for an exceedance in the RSD for sand levels in the 0- to 4-inch bss depth interval in S2A1. Therefore, it was concluded that the Hand Corer is generally able to collect multiple samples with consistent physical characteristics.

**7.1.4 Ability to be Adequately Decontaminated**

Primary objective P5 involved evaluating the reference samplers’ ability to be adequately decontaminated. This objective was addressed by collecting equipment rinsate samples after sampler decontamination activities in S1A1 and S2A1. Specifically, the 6- to 12-inch bss depth interval in S1A1 and the 0- to 4-inch bss depth interval in S2A1 were chosen as the depth intervals where P5 was evaluated because they contained high concentrations of PCBs and arsenic, respectively. Although it was intended that the evaluation of P5 be limited to these depth intervals, because samples were simultaneously collected in multiple depth intervals, the primary objective was

addressed for a given area, not for a given depth interval. However, this deviation did not impact the evaluation of primary objective P5.

If the reference samplers were adequately decontaminated, the analytical results for the equipment rinsate samples would be below the analytical laboratory’s reporting limits. To ensure that the water used to decontaminate the samplers was not itself contaminated, decontamination water blanks were also analyzed. Contaminant concentrations in both the equipment rinsate samples and decontamination water blanks were below the laboratory reporting limits for PCBs (1 part per billion) and arsenic (10 parts per billion). Thus, both the Vibrocorer and Hand Corer demonstrated the ability to be adequately decontaminated.

**7.1.5 Time Requirements for Sample Collection Activities**

Primary objective P6 involved evaluating the reference samplers’ time requirements for sample collection activities. These requirements were evaluated in all four demonstration areas but were not specifically evaluated by depth interval because samples were simultaneously collected in multiple depth intervals to reduce the overall sample collection time. For the Hand Corer, one technician was required for sampler setup, sample collection, sampler disassembly, and sampler decontamination, except in S2A1 where two technicians were required for sample collection. For the Vibrocorer, two technicians were required for sampler setup and

sample collection, and one technician was required for sampler decontamination in S1A1. Sampler disassembly was not necessary because the Vibrocorer is a permanent fixture aboard the EPA GLNPO's *Mudpuppy* and does not contain components that require disassembly.

The amounts of time required to complete the sampling activities are shown in Table 7-6. The time measured for sample collection activities did not include the time taken for mobilization, demobilization, and maneuvering the sampling platforms to sampling locations because these latter activities were not sampler-specific; rather, they were either site- or weather-related.

To complete sampling activities in S1A1, the Vibrocorer required 8 minutes for sampler setup, 124 minutes for sample collection in the 0- to 4- and 6- to 12-inch bss depth intervals (15 to 16 minutes per attempt), and 10 minutes for sampler decontamination.

For the Hand Corer, sampler setup required 4 minutes in S1A2. Sampler setup times are not available for S2A1 and S2A2. In S2A1, the setup time was included in the sample collection time for one particular sample, and in S2A2, the setup time was not recorded. However, the setup time recorded at S1A2 is probably representative of the time needed for a moderately experienced technician to set up the Hand Corer; S1A2 was the last demonstration area sampled with the Hand Corer, so the technician had ample opportunity to practice sampler setup in other areas.

Sample collection times for the Hand Corer ranged from 47 to 550 minutes in S1A2, S2A1, and S2A2. Sample

collection with the Hand Corer required 4 to 7 minutes per attempt in S1A2 and S2A2 but 10 to 16 minutes per attempt in S2A1. More extension rods were required in S2A1 than in the other two areas because of the water depth; five rods were required in S2A1, but only one rod was required in S1A2 and S2A2. The weight of the additional extension rods made use of a tripod-mounted winch necessary to hold the sampler steady during sampling; incorporating the tripod-mounted winch into the sampling process in S2A1 accounted for the extra time necessary for sample collection.

Hand Corer disassembly required 2 minutes in S1A2 and S2A2 but 4 minutes in S2A1. The additional time required in S2A1 can again be attributed to the use of additional extension rods in this area.

Decontamination of the Hand Corer was evaluated only in S2A1 and required 40 minutes. Because of the numerous extension rods required in this area, the decontamination time measured in S2A1 may not be representative. In addition, S2A1 was the first demonstration area sampled, and decreased decontamination times were observed for the other samplers as the technicians became more familiar with the decontamination procedures required for the demonstration.

In summary, a technician familiar with the Vibrocorer would be expected to require 8 minutes for sampler setup, 15 to 16 minutes for each sampling attempt, and 10 minutes for sampler decontamination. A technician familiar with the Hand Corer would be expected to require 4 minutes for sampler setup, 4 to 7 minutes for each

**Table 7-6. Time Required to Complete Sampling Activities for Reference Samplers**

Activity	Time Required (minutes)			
	S1A1 (River Mouth) Vibrocorer	S1A2 (Freshwater Bay) Hand Corer	S2A1 (Lake) Hand Corer	S2A2 (Wetland) Hand Corer
Sampler setup	8	4	Included in sample collection	Not recorded
Sample collection	124	47	550	163 <sup>a</sup>
Sampler disassembly	0	2	4	2
Sampler decontamination	10	Not evaluated	40	Not evaluated
Total	142	53	594	165 <sup>a</sup>

Note:

<sup>a</sup> Hand Corer sampling was completed at four of five sampling locations. At the fifth location, sampling was discontinued after 12 attempts failed to collect the specified sediment volume.

sampling attempt, and 2 to 4 minutes for sampler disassembly. However, more time may be necessary for sample collection depending on the water depth. It is uncertain how much time an experienced technician would need to adequately decontaminate the Hand Corer, but it is likely that the technician would require less than the 40 minutes observed in S2A1. The amount of decontamination time would likely have been less in the other areas because the technician would have had more practice in implementing the required decontamination procedures as well as fewer extension rods to decontaminate. When sediment sampling activities are planned, the time required for setting up the sampling platform and for maneuvering the platform to position the sampler at the sampling location would have to be considered in addition to the times presented above.

## 7.2 Secondary Objectives

This section discusses the performance results for the reference samplers based on secondary objectives S1 through S5 stated in Section 4.1. Secondary objectives were addressed based on observations of the reference samplers' performance during the demonstration and on information provided by the EPA GLNPO.

### 7.2.1 *Skill and Training Requirements for Proper Sampler Operation*

The Hand Corer is easy to operate, requiring minimal skills and training. Sampler assembly and sample collection procedures can be learned in the field with a few practice attempts. In addition, a written SOP accompanies the sampler when it is procured. The sampler can be operated by one person in shallow (wading) water depths because of its lightness (12 lb). Sampler operation with plastic core liners is simple because the sampler does not require complete disassembly and reassembly after each sampling attempt. Only the nose piece requires removal to extrude the plastic core liner containing the sediment core. In water depths requiring use of extension rods, sampler operation becomes more cumbersome because of the combined weight of the stainless-steel sampler and the galvanized-steel extension rods (5 lb each). Because of the heaviness of the sampler equipped with five extension rods, two personnel and a tripod-mounted winch were needed to deploy and retrieve the sampler at each sampling location in S2A1, where the water depth was about 18 feet.

During the demonstration, minimal strength and stamina were required to collect samples with the Hand Corer from shallow and moderate depth intervals containing both unconsolidated and consolidated sediments. Specifically, minimal strength and stamina were required to drive the sampler into and retrieve it from the 0- to 4-inch bss depth interval in S1A2 and S2A1 and the moderate depth intervals ranging from 10 to 30 and 12 to 32 inches bss in S2A1 and S1A2, respectively. However, moderate to significant strength and stamina were required to collect samples from a depth interval containing partially decomposed reeds and leaves and live vegetation. Specifically, moderate to significant strength and stamina were required to drive the sampler into and retrieve it from the 4- to 12-inch bss depth interval in S2A2. Sediment in this interval was consolidated and was predominantly sand with low water content. The consolidated interval increased the amount of force required to drive the Hand Corer. However, the difficulty in driving the sampler was likely attributable to the sampler's inability to cut through the sediment that contained significant amounts of partially decomposed reeds and leaves and live vegetation.

Previous sediment sampling experience is beneficial in selecting the most appropriate support equipment for a given Hand Corer application. For example, the sampling technicians chose to use a tripod-mounted winch in S2A1 because of the significant strength and stamina that would have been required to deploy and retrieve the sampler in that area if a winch was not used. Previous sediment sampling experience is also beneficial in accurately assessing the location of the sediment surface using the sampler, as is the case with other samplers.

Operation of the Vibrocorer requires moderate skills and training, and the sampler must be operated by at least two persons using a sampling platform. Several hours of hands-on training with an experienced Vibrocorer sampling technician is recommended to learn the proper operation of the sampler and its support equipment. In addition, during the demonstration, the power supply for the Vibrocorer malfunctioned during sample collection. The source of the malfunction was identified and corrected by on-site personnel. Therefore, it is recommended that at least one of the sampling technicians have electrical and mechanical experience to be able to correct malfunctioning support equipment for the Vibrocorer. Also, previous sediment sampling experience is beneficial

in assessing the location of the sediment surface using the sampler, as is the case with other samplers.

During the demonstration, minimal strength and stamina were required to collect samples with the Vibrocorer in S1A1. Although the vibrohead and core tube weigh about 150 lb, sampler deployment and retrieval were controlled with an A-frame and winch on the EPA GLNPO's *Mudpuppy*. The physical effort required to remove the core tube from the vibrohead and to extract the sample from the core tube was minimal.

### 7.2.2 Ability to Collect Samples Under a Variety of Site Conditions

The Hand Corer demonstrated its ability to collect sediment samples under all conditions encountered during the demonstration, which included a variety of sampling platforms, water depths, sediment depths, and sediment compositions. The range of sampling platforms used included wooden planks fastened to ladders in S2A2; an 18-foot-long, 4-foot-wide Jon boat in S1A2; and a sturdier, 30-foot-long, 8-foot-wide pontoon boat in S2A1. Because the sampler does not require electricity or a tripod-mounted winch for deployment in shallow water, sampler operation was feasible from any location on the sampling platforms used in S1A2 and S2A2. At S2A1, however, where the water depth was about 18 feet, two sampling technicians and a tripod-mounted winch were needed to properly operate the sampler because of the combined weight of the sampler (12 lb) and the five extension rods and turning handle (27 lb). Use of the tripod-mounted winch required that a 6-inch-diameter hole be cut in the center of the pontoon boat to deploy and retrieve the sampler.

As with other samplers, the ability to assess the location of the sediment surface with the Hand Corer decreases with increasing water depth and turbidity. Because of the significant water depth in S2A1 and turbidity in S1A2, the sampling technicians could not see the sediment surface from the sampling platforms. An underwater video camera may have enabled the sampling technicians to accurately assess the location of the sediment surface in these areas (Blomqvist 1991).

The Hand Corer was able to collect sediment samples in all shallow and moderate depth intervals (less than

36 inches bss) in each demonstration area where the sampler was deployed. However, as discussed in Section 7.1.1.1, the actual number of attempts required to collect the specified volume of sediment exceeded the expected number at most sampling locations. The additional attempts may be attributable to (1) error in assessing the location of the sediment surface, which may have resulted in the actual depth of penetration being less than the measured depth of penetration; (2) deficient entry of sediment into the core tube (core shortening); (3) plug formation in the coring tip that inhibited further sediment retrieval; or (4) partial or complete loss of the sediment core through the bottom end of the sampler as a result of partial or complete loss of vacuum in the core tube caused by incomplete closure of the flutter valve. Incomplete closure of the flutter valve was observed during a few attempts in S2A2 when partially decomposed plant matter in the 0- to 4-inch bss depth interval became lodged between the flutter valve and core tube. Core shortening (in which the actual core length retrieved is less than the depth of sediment penetration) primarily involves deficient entry of sediment into the core tube during core tube penetration. Physically, sediment friction against the inside wall of the core tube causes thinning of the core by lateral extrusion in front of the core tube. As the friction changes with depth, not all sediment layers may be uniformly represented in the sample (Blomqvist 1991).

The Vibrocorer demonstrated its ability to consistently collect sediment samples in the 0- to 4- and 6- to 12-inch bss depth intervals at all locations in S1A1. As discussed in Section 7.1.1.1, the actual number of attempts required to collect the specified volume of sediment in these depth intervals did not exceed the expected number at any sampling locations. However, the sampler could not collect cores longer than 4.4 feet. The Vibrocorer's difficulty in collecting sediment in the 4- to 6-foot bss depth interval may be attributed to the sampler not being able to penetrate clay hardpan observed in the sampling area about 5 feet bss.

The Vibrocorer was unable to collect samples in S1A2, as was originally intended. The sampler was installed on the EPA GLNPO's *Mudpuppy*, which requires a minimum water depth of 3 feet for maneuvering. Because the water depth in S1A2 was only about 2 feet during the demonstration, the *Mudpuppy* was unable to enter the area.



### 7.2.3 *Ability to Collect an Undisturbed Sample*

During the demonstration, both the Hand Corer and Vibrocorer consistently collected sediment samples in which the sediment stratification was preserved; however, based on visual observations, the samples appeared to have been compacted. Bow wave disturbance near the sediment surface did not occur in S2A2; the water depth (0.5 to 1.5 feet) and low turbidity in this area allowed visual confirmation of the location of the sediment surface. Bow wave disturbance near the sediment surface in the remaining demonstration areas was unlikely because the speed of sampler deployment was controlled for each sampler. As mentioned above, sediment stratification was preserved for samples collected in these areas.

For both samplers, the total core length retrieved in each attempt was less than the depth of sampler deployment. The difference between the total core length retrieved and the depth of sampler deployment for the Hand Corer ranged from 15 to 25 inches in S1A2, 1 to 36 inches in S2A1, and 12 to 67 inches in S2A2. For the Vibrocorer, the difference ranged from 10.5 to 38.5 inches. As discussed above, these differences may have resulted for the reasons described in Section 7.2.2. Furthermore, these differences indicate that sampling bias might have occurred during sample collection in a given target depth interval.

### 7.2.4 *Durability Based on Materials of Construction and Engineering Design*

The primary components of the Hand Corer include (1) a Lexan™ nose piece; (2) a 36-inch-long, stainless-steel core tube; (3) a stainless-steel head piece with a flutter valve; (4) two detachable, stainless-steel handles; and (5) a clevis (see Figure 5-1). Based on observations made during the demonstration, the Hand Corer is a sturdy sampler; none of the sampler components was damaged or required repair or replacement during the demonstration.

The Hand Corer was also equipped with varying lengths of galvanized-steel extension rods during the demonstration. One extension rod was used to collect samples in shallow water at S1A2 and S2A2. In both areas, no bending or bowing of the extension rod was observed. In S2A1, five extension rods were coupled together to a combined length of about 25 feet. Throughout most of the sampling in S2A1, minimal

bowing of the coupled extension rods was observed during sediment penetration. During one sampling attempt in S2A1, the pontoon boat drifted after the sampler had been deployed through the 6-inch-diameter hole in the middle of the boat and had been driven into the sediment. The resulting stress on the extension rods caused one of the rods to be damaged at the threads.

The primary components of the Vibrocorer include (1) an anodized-aluminum, pressure-housed vibrohead with a terminal for an electric cable; (2) a disposable, 10-foot-long, 4-inch-diameter, plastic core tube equipped with a plastic core catcher; (3) a core tube clamp; and (4) a guide rope (see Figure 5-2). Based on observations made during the demonstration, the Vibrocorer is a sturdy sampler; none of the primary components of the sampler was damaged or required repair or replacement during the demonstration. The primary component of the Vibrocorer, the vibrohead, has an operating expectancy of about 10,000 hours. However, as discussed above, the power supply for the Vibrocorer malfunctioned during sample collection. The source of the malfunction (moisture in the control box between the power source and vibrohead) was identified and corrected by on-site personnel.

### 7.2.5 *Availability of Sampler and Spare Parts*

No primary component of the Hand Corer required replacement or servicing during the demonstration. Had a primary sampler component required replacement, it would not have been available in local retail stores. As discussed above, an extension rod was damaged at the threads during sampling in S2A1 and required replacement. The replacement rod was acquired within a few hours in a local retail store. Replacement extension rods and primary sampler components may be obtained from the developer by overnight courier in 2 days or less, depending on the location of the sampling site. During sampling in S1A2, the sampling technician was able to acquire additional plastic core tube liners from the developer by overnight courier. The developer pre-cut the plastic core tube liners in response to a special request from the sampling technician. During sampling in S2A1 and S2A2, the sampling technician was able to have plastic core tube liners pre-cut at a local machine shop.

No primary component of the Vibrocorer required replacement or servicing during the demonstration. However, as discussed above, the power supply for the

Vibrocorer malfunctioned and required servicing. The source of the malfunction was identified and corrected by on-site personnel within a few hours. Had on-site personnel been unable to correct the malfunction, servicing of the power supply by an off-site electrician would have been necessary. Had the vibrohead malfunctioned, it would have been packaged and shipped to the developer for servicing. Because the vibrohead is pressure-sealed, servicing of the vibrohead is not recommended in the field or by an unskilled sampling technician. Plastic core tubes for the Vibrocorer may be available from a local plastic manufacturer; however, their availability should be verified prior to a sampling event, especially one in a remote location. Core tube catchers used by GLNPO can be made from materials readily available in a hardware store.

### 7.3 Data Quality

The overall QA objective for the demonstration was to produce well-documented data of known quality. The TSAs conducted to evaluate data quality did not reveal any problems that would make the demonstration data unusable. The scope of these TSAs is described in Sections 4.3 and 4.4 of this ITVR.

This section briefly discusses the data quality of demonstration results for the reference samplers; more detailed information is provided in the DER (Tetra Tech 1999c). Specifically, the data quality associated with the field measurement activities is discussed first, followed by the data quality associated with the laboratory analysis activities.

#### 7.3.1 Field Measurement Activities

Field measurement activities conducted during the demonstration included measurement of the time associated with sample collection activities, water velocity, water depth, core length, volume of IDW, volume of sediment collected in a given sampling attempt, and depth of sampler deployment. Of these measurement parameters, specific acceptance criteria were set for the precision associated with the time and water velocity measurements only (EPA 1999). All time and water velocity measurements made during the demonstration met their respective criteria (see Table 6-7). Of the remaining parameters, some difficulties were encountered in measuring the volume of sediment collected in a given

sampling attempt and the depth of sampler deployment, which are discussed below.

To measure the volume of sediment collected in a given sampling attempt, the sediment sample was transferred into a 2-L container graduated in increments of 20 mL. The container was tapped on a hard surface to minimize the presence of void spaces in the sample, the sample surface was made even using a spoon, and the volume of the sample was measured. However, because the void spaces could not be completely eliminated, the volumetric measurements are believed to have a positive bias that resulted in overestimation of PSRs. Because the total volume of the void spaces could not be measured, its impact on the PSR results could not be quantified. However, because the same volumetric measurement procedure was used for both the innovative and reference samplers, the PSR results could still be compared.

The depth of sampler deployment was measured with reference to the sediment surface. To identify the location of the sediment surface, the sampling technicians lowered the sampler into the water and used the bottom end of the sampler to feel the sediment surface. Subsequently, the technicians drove the sampler into the sediment to a depth that they estimated to be appropriate to collect a sediment sample in the specified depth interval. For the Vibrocorer in S1A1, this approach resulted in an average core length that was about 23 percent shorter than the estimated depth of sampler deployment, indicating that the sampling technicians may have had difficulty assessing the location of the sediment surface. For the Hand Corer in the remaining three areas, the average core length retrieved was shorter than the estimated depth of sampler deployment, again indicating that the sampling technicians may have had difficulty assessing the location of the sediment surface. Specifically, for the Hand Corer in S1A2, S2A1, and S2A2, the average core length was shorter than the estimated depth of sampler deployment by 52, 41, and 78 percent, respectively. Because the reference samplers used in the demonstration are end-filling samplers that do not have the advantage of collecting uncompressed sediment samples as does the Russian Peat Borer, which is a side-filling sampler, conclusions drawn from a comparison of the sediment characteristics of the samples collected by the reference samplers with those of the samples collected by the Russian Peat Borer should be carefully interpreted.



### 7.3.2 Laboratory Analysis Activities

The laboratory analyses conducted for the demonstration included the following: (1) PCB, arsenic, and PSD analyses of sediment samples and (2) PCB and arsenic analyses of equipment rinsate samples. To evaluate the data quality of the laboratory analysis results, field-generated QC samples, PE samples, and laboratory QC check samples were analyzed. The field-generated QC samples included the field replicates and temperature blanks described in Section 4.3 of this ITVR. The PE samples and laboratory QC check samples are described in Section 4.4. The acceptance criteria for the QC samples are presented in Table 6-7.

All temperature blanks and field replicates subjected to PCB and arsenic analyses met the acceptance criteria, indicating that the sample homogenization procedure (field replicates) and sample preservation procedure (temperature blanks) implemented in the field met the demonstration requirements. However, as stated in Section 7.1.3, in a few cases the results of field triplicate sample analyses for PSD did not meet the acceptance criterion. Despite the failures to meet the acceptance criterion, the PSD results are considered to be valid for the reasons detailed in Section 7.1.3.

The PE sample results for both PCB and arsenic analyses met the acceptance criteria, indicating that the analytical laboratory accurately measured PCBs and arsenic.

The analytical results for all laboratory QC check samples except the following met the acceptance criteria: (1) MS/MSD samples for analysis for PCBs in the sediment matrix and (2) equipment rinsate samples for PCB analysis. These issues and their likely impact on data quality are discussed below.

For the sediment matrix, in all MS/MSD samples analyzed for PCBs, Aroclor 1016 was recovered at levels higher than the upper limit of the acceptance criterion, indicating a positive bias in the PCB results for sediment samples.

However, the analytical laboratory had no problem meeting the acceptance criteria for control samples such as BS/BSDs. For this reason, the failure to meet the acceptance criterion for MS/MSD sample analysis was attributed to matrix interference. Because Aroclor 1016 was recovered at levels higher than the upper limit of the acceptance criterion in all MS/MSD samples associated with both the innovative and reference samplers, the PCB results could still be compared. The MS/MSD spiking compounds (Aroclors 1016 and 1260) were selected based on the Aroclors detected during the predemonstration investigation and as recommended in SW-846 Method 8082.

Also for the sediment matrix, in one out of three MS/MSD pairs analyzed for PCBs, Aroclor 1260 was recovered at a level less than the lower limit of the acceptance criterion in the MS sample, but the recovery in the associated MSD sample was acceptable. Because the investigative samples contained only Aroclor 1242, of the two spiking compounds used to prepare the MS/MSD samples, only the Aroclor 1016 recoveries were considered to be relevant based on the PCB congener distribution; the Aroclor 1260 recoveries were not considered to be relevant. Therefore, the low recovery associated with Aroclor 1260 had no impact on data quality.

In all equipment rinsate samples analyzed for PCBs, decachlorobiphenyl (the surrogate) was recovered at levels lower than the lower limit of the acceptance criterion, indicating a negative bias in the PCB results for equipment rinsate samples. However, the analytical laboratory had no problem meeting the acceptance criteria for control samples such as PE samples and deionized water blanks. For this reason, the failure to meet the surrogate recovery acceptance criterion for the equipment rinsate sample analysis was attributed to matrix interference. Because the surrogate was recovered at levels lower than the lower limit of the acceptance criterion in all equipment rinsate samples associated with both the innovative and reference samplers, the PCB results could still be compared.

---

## Chapter 8 Economic Analysis

As discussed throughout this ITVR, the Russian Peat Borer was demonstrated at two sites, each consisting of two areas. This chapter presents an economic analysis of sediment sample collection using the Russian Peat Borer in two of the four demonstration areas: (1) a river mouth contaminated with PCBs (S1A1) and (2) a lake contaminated with arsenic (S2A1). These areas were selected for the economic analysis because the varied sampling conditions in these areas provide a range of costs involved in conducting sediment sampling using the Russian Peat Borer. For example, during the demonstration in S1A1, the water depth was about 5 to 6 feet, and sediment samples were collected in three depth intervals: 0 to 4 inches bss, 6 to 12 inches bss, and 4 to 6 feet bss. On the other hand, in S2A1, the water depth was about 18 feet, and sediment samples were collected in two depth intervals: 0 to 4 and 10 to 30 inches bss.

The purpose of this economic analysis is to estimate the costs of using the Russian Peat Borer to collect sediment samples in environments similar to S1A1 and S2A1. The analysis is based on the results of the demonstration, unit costs in published cost data sources, and costs provided by the technology developers or equipment vendors.

This chapter provides information on the issues and assumptions involved in the economic analysis (Section 8.1), discusses the costs associated with using the Russian Peat Borer (Section 8.2), discusses the costs associated with using the reference samplers (Sections 8.3 and 8.4), and presents a comparison of the economic analysis results for the Russian Peat Borer and reference samplers (Section 8.5).

### 8.1 Issues and Assumptions

Several factors affect sediment sampling costs. In this economic analysis, wherever possible, these factors are identified such that decision-makers can independently complete a site-specific economic analysis. Costs included in the analysis are divided into four categories: sampler, labor, IDW disposal, and support equipment costs. The issues and assumptions associated with these categories and the costs not included in this analysis are briefly discussed below.

#### 8.1.1 Sampler Costs

Sampler costs include the costs of samplers and associated equipment used during the demonstration, such as extension rods and core tube liners, as applicable. These costs were provided by the technology developers or equipment vendors.

#### 8.1.2 Labor Costs

Labor costs cover the time required for sampler setup, sample collection, sampler disassembly, and sampler decontamination. In this analysis, the actual amount of time required for sample collection activities during the demonstration is used as the labor requirement, and all labor times are rounded off to the nearest half-hour. Because it may not be feasible to hire sampling technicians for a fraction of a day, a site-specific analysis should consider the local availability of such technicians and modify labor cost estimates accordingly. In this analysis, an hourly rate of \$13.51 is used for a technician (R.S. Means Company [Means] 1999), and a multiplication factor of 2.5 is applied to labor costs in order to account for general and administrative and

overhead costs. Thus, an hourly rate of \$34 is used for a technician.

### 8.1.3 IDW Disposal Costs

IDW disposal costs cover disposal of unused sediment and spent core tube liners. Unused sediment was assumed to be a nonhazardous waste because during the demonstration, the sediment PCB concentrations in S1A1 did not exceed 3.7 parts per million, and wastes containing PCB concentrations less than 50 parts per million can be disposed of as nonhazardous waste (40 Code of Federal Regulations [CFR] 761). Similarly, arsenic-contaminated wastes that are not listed wastes with toxicity characteristic leaching procedure (TCLP) extract concentrations less than 5 milligrams per liter (mg/L) can be disposed of as nonhazardous waste (40 CFR 261). During the demonstration, the maximum and average arsenic concentrations in sediment in S2A1 were 300 and 70 mg/kg, respectively. Based on the average arsenic concentration and the dilution factor (20) associated with the TCLP, the TCLP extract concentration for the sediment waste generated during the demonstration was estimated to be about 3.5 mg/L. Therefore, unused sediment in S2A1 was also assumed to be a nonhazardous waste.

During the demonstration, insignificant quantities of sediment were present on the spent core tube liners. Therefore, the spent core tube liners were also assumed to be a nonhazardous waste. Also, as shown in Table 8-1, the samplers generated different quantities of IDW in each demonstration area. However, the volume of IDW generated by each sampler in each area was less than 55 gallons. Because the cost to package, load, transport,

and dispose of smaller containers is generally the same as the cost to perform these activities for one 55-gallon drum, it is assumed that the IDW in each area would be collected in a 55-gallon drum. As a result, the cost for IDW disposal is the same for each sampler. However, if larger numbers of samples were to be collected and the resulting IDW volume were larger, differences in IDW disposal costs among samplers would become apparent. The cost to package, load, transport, and dispose of one 55-gallon drum of nonhazardous waste is \$182 (Means 1999).

### 8.1.4 Support Equipment Costs

Support equipment includes equipment used for sampler preparation, sample extrusion, and other activities associated with sample collection. Examples of support equipment are a tripod-mounted winch and an electrical power generator.

### 8.1.5 Costs Not Included

Items whose costs are not included in this analysis are identified below along with a rationale for the exclusion of each.

**Oversight of Sampling Activities.** A typical user of a sampler would not be required to pay for customer oversight of sample collection. EPA representatives audited all activities associated with sample collection during the demonstration, but costs for EPA oversight are not included in this analysis because they are project-specific and not sampler-dependent. In addition, if physical characterization of sediment samples is required to be performed in the field, a soil scientist may be necessary. However, costs for such oversight are not

**Table 8-1. Comparison of Investigation-Derived Waste Quantities Generated by Russian Peat Borer and Reference Samplers**

Demonstration Area	Sampler	Quantity of Investigation-Derived Waste		
		Unused Sediment (liters)	Number of Core Tubes	Number of Core Tube Liners
S1A1 (river mouth)	Russian Peat Borer	4	Not applicable	Not applicable
	Vibrocorer	45	5 <sup>a</sup>	Not applicable
S2A1 (lake)	Russian Peat Borer	20	Not applicable	Not applicable
	Hand Corer	12	Not applicable	41 <sup>b</sup>

Notes:

<sup>a</sup> 10-foot-long, 4-inch-diameter, plastic core tubes

<sup>b</sup> 36-inch-long, 2-inch-diameter, plastic core tube liners

included in this analysis because they are project-specific and not sampler-dependent.

**Health and Safety Personnel.** Health and safety personnel are required to be present during hazardous waste site operations, but they are not directly involved in sample collection activities.

**Analyses of Samples Collected.** Analytical costs can vary greatly depending on site-specific contaminants and are not directly related to sample collection costs.

**Personal Protective Equipment.** The type of personal protective equipment required can vary greatly depending on site-specific contamination and hazards, and the cost of such equipment is not sampler-dependent.

**Disposal of Decontamination Water.** Decontamination water may frequently be disposed of without incurring additional costs (as was the case during the demonstration).

**Travel and Per Diem for the Sampling Team.** Members of the sampling team may be available locally. For the demonstration, the sampling team consisted of both local and nonlocal staff. Because the availability of sampling team members is a function of the geographic location of the sampling site and does not depend on the samplers, travel and per diem costs for the sampling team are not included in this analysis.

**Boat Rental.** A boat may or may not be necessary for sediment sampling, depending on site conditions and the sampler chosen. Because the cost of boat rental is not included in this analysis, other costs associated with using a boat, such as fuel costs, are also not included.

**Time Spent in Maneuvering the Sampling Platform.** The time required to maneuver the sampling platform varies greatly depending on site conditions such as water depth and weather. For example, when the wind velocity was high during the demonstration, a significant amount of time was spent maneuvering the EPA GLNPO's *Mudpuppy* (in S1A1) and the pontoon boat (in S2A1); as a result, the sampling sometimes had to be discontinued for the day. Because these delays were not sampler-dependent, the time spent in maneuvering the sampling platforms is not included in this analysis.

**Time Spent in Managing the Samples.** The time required to homogenize the sediment, fill and label sample containers, prepare sample containers for shipment, fill out chain-of-custody forms, and ship the samples varies greatly depending on the number of samples collected and site location. Therefore, the time spent in managing the samples is not included in this analysis because it is project-specific and not sampler-dependent.

**Mobilization and Demobilization.** Mobilization and demobilization costs vary greatly depending on the site location and conditions. For the demonstration, mobilization and demobilization activities were mainly associated with procuring sampling platforms and setting up sample management areas. The sampling platforms used were selected based on their availability but not necessarily based on sampler requirements. For example, in S1A1, the EPA GLNPO's *Mudpuppy* was used because it was available free of charge from EPA Region 5. Also, two tents were set up for sample management in S1A1 and S2A1 to avoid delays resulting from inclement weather but not based on sampler requirements. Therefore, mobilization and demobilization costs are not included in this analysis.

**Commonly Available Support Equipment.** The cost of support equipment that is commonly available and likely would not be purchased specifically for sampling is not included in this analysis. For example, the cost of wrenches and tape measures is not included in this analysis because it is assumed that a field sampling team would already have such tools as part of its field sampling gear.

**Support Equipment That Costs Less Than \$10.** The cost of inexpensive support equipment, such as stainless-steel spoons and mixing bowls used to homogenize sediment samples is not included in this analysis. In addition, the cost of fuel consumed to operate support equipment such as a generator is not included because, based on the fuel consumed during the demonstration, the fuel cost was estimated to be less than \$10.

## 8.2 Russian Peat Borer Costs

This section presents information on sampler, labor, IDW disposal, and support equipment costs for the Russian Peat Borer as well as a summary of these costs. Table 8-2 presents these costs.

**Table 8-2. Russian Peat Borer Cost Summary**

Item	Quantity	Unit Cost (\$)	Total Cost (\$)
<b>S1A1 (River Mouth) Costs</b>			
Sampler			
Model A	1 unit	835	835
Model C	1 unit	1,350	1,350
40-inch-long, aluminum extension rods	4 units	55	220
Labor	1.5 hours	34	51
IDW disposal	1 55-gallon drum	182	182
Support equipment			
Slide-hammer mechanism	1 unit	95	95
<b>Total<sup>a</sup></b>			<b>\$2,730</b>
<b>S2A1 (Lake) Costs</b>			
Sampler			
Model B	1 unit	1,250	1,250
Model C	1 unit	1,350	1,350
3-foot-long, aluminum extension rods	3 units	55	165
4-foot-long, aluminum extension rods	3 units	65	195
Labor	2.5 hours	34	85
IDW disposal	1 55-gallon drum	182	182
Support equipment			
Sawhorses	2 units	15	30
<b>Total<sup>a</sup></b>			<b>\$3,260</b>

Notes:

IDW = Investigation-derived waste

<sup>a</sup> The total dollar amount is rounded to the nearest \$10.

### 8.2.1 Sampler Cost

In S1A1, ARI used two different models of the Russian Peat Borer: (1) a 2-inch-diameter, 20-inch-long model (A) and (2) a 3-inch-diameter, 25-inch-long model (C). The purchase costs for Models A and C were \$835 and \$1,350, respectively. In addition, ARI used four 40-inch-long, aluminum extension rods costing \$55 each. The total sampler cost for S1A1 was estimated to be \$2,405 (Tetra Tech 1999a).

In S2A1, ARI used two different models of the Russian Peat Borer: (1) a 2-inch-diameter, 40-inch-long model (B) and Model C. The purchase costs for Models B and C were \$1,250 and \$1,350, respectively. In addition, ARI used three 4-foot-long and three 3-foot-long, aluminum extension rods costing \$65 and \$55 each, respectively. The total sampler cost for S2A1 was estimated to be \$2,960 (Tetra Tech 1999a).

### 8.2.2 Labor Cost

In S1A1, the time for sampler setup, sample collection, sampler disassembly, and sampler decontamination totaled 88 minutes or about 1.5 hours for one technician. In this area, five investigative samples each were collected in the 0- to 4- and 6- to 12-inch bss depth intervals as well as in the 4- to 6-foot bss depth interval using the Russian Peat Borer. Table 4-3 presents additional information on the total number of samples collected. The labor cost for sampling in S1A1 was estimated to be \$51.

In S2A1, the time for sampler setup, sample collection, sampler disassembly, and sampler decontamination totaled 149 minutes or about 2.5 hours for one technician. In this area, 15 investigative samples each were collected in the 0- to 4- and 10- to 30-inch bss depth intervals using the Russian Peat Borer. The labor cost for sampling in S2A1 was estimated to be \$85.



### 8.2.3 IDW Disposal Cost

Sampling in S1A1 generated IDW consisting of 4 L of unused sediment. The cost for disposal of one 55-gallon drum of nonhazardous waste is \$182.

Sampling in S2A1 generated IDW consisting of 20 L of unused sediment. The cost for disposal of one 55-gallon drum of nonhazardous waste is \$182.

### 8.2.4 Support Equipment Cost

Support equipment used during Russian Peat Borer sampling in S1A1 included a 10-lb ARI slide-hammer mechanism, two slip wrenches, two window ice scrapers for sample extrusion, and one file used to sharpen the core tube edge. The cost of the slip wrenches is not included in this analysis because a field sampling team would already have such tools as part of its field sampling gear. The ice scrapers and file individually cost less than \$10. The cost of the slide-hammer mechanism used in S1A1 was estimated to be \$95.

Support equipment used during Russian Peat Borer sampling in S2A1 included two slip wrenches, two

window ice scrapers for sample extrusion, one file used to sharpen the core tube edge, and two sawhorses. The cost of the slip wrenches is not included in this analysis because a field sampling team would already have such tools as part of its field sampling gear. The ice scrapers and file individually cost less than \$10. The total cost of the sawhorses used in S2A1 was estimated to be \$30.

### 8.2.5 Summary of Russian Peat Borer Costs

In summary, for the Russian Peat Borer, the costs to collect the number of samples listed in Table 4-3 were estimated to be \$2,730 and \$3,260 for S1A1 and S2A1, respectively. This economic analysis shows that most of the total cost (about 80 percent) was associated with the purchase of samplers. The remaining 20 percent was associated with labor, IDW disposal, and support equipment costs.

## 8.3 Hand Corer Costs

This section presents information on sampler, labor, IDW disposal, and support equipment costs for the Hand Corer as well as a summary of these costs. Table 8-3 presents these costs.

**Table 8-3. Hand Corer Cost Summary for S2A1 (Lake)**

Item	Quantity	Unit Cost (\$)	Total Cost (\$)
Sampler			
Hand Corer	1 unit	329	329
Core tube liners <sup>a</sup>	4 dozen	192	768
Galvanized-steel extension rods	5 units	93	465
Labor			
Technicians	20 hours	34	680
Cut liners	41 units	3	123
IDW disposal	1 55-gallon drum	182	182
Support equipment			
Tripod-mounted winch	1 unit for 3 days	40	120
<b>Total<sup>b</sup></b>			<b>\$2,670</b>

Notes:

IDW = Investigation-derived waste

<sup>a</sup> Consumable supplies

<sup>b</sup> The total dollar amount is rounded to the nearest \$10.



### 8.3.1 Sampler Cost

The Hand Corer purchase cost was approximately \$329. During the demonstration, 41 core tube liners and five 5-foot-long, galvanized-steel extension rods were used in S2A1. Liners were purchased in four packages of 12 at a cost of \$192 per package. The purchase cost of each extension rod was \$93. The total sampler cost was estimated to be \$1,562.

### 8.3.2 Labor Cost

In S2A1, the time required for sampler setup, sample collection, sampler disassembly, and sampler decontamination totaled 594 minutes or about 10 hours for each of two technicians. In addition, to facilitate sample extrusion, 41 core tube liners were cut at a local machine shop at a cost of \$3 each, for a total cost of \$123. In this area, 15 investigative samples each were collected in the 0- to 4- and 10- to 30-inch bss depth intervals using the Hand Corer. Table 4-3 presents additional information on the total number of samples collected. The labor cost for sampling was therefore estimated to be \$803. When field technicians work more than 8 hours in one day, overtime costs may be incurred. This estimate, however, includes no overtime costs.

### 8.3.3 IDW Disposal Cost

Sampling in S2A1 generated IDW consisting of 12 L of unused sediment and 41 core tube liners. The total volume of IDW generated was less than 55 gallons. The cost for disposal of one 55-gallon drum of nonhazardous waste is \$182.

### 8.3.4 Support Equipment Costs

Support equipment used during Hand Corer sampling included a tripod-mounted winch. The tripod-mounted winch was rented for 3 days at a daily rate of \$40 (Hazco 1999). The total cost of the support equipment was estimated to be \$120.

### 8.3.5 Summary of Hand Corer Costs

In summary, for the Hand Corer, the costs to collect the number of samples listed in Table 4-3 were estimated to be \$2,670. This economic analysis shows that most of the total cost was associated with sampler purchase (59 percent) and labor (30 percent). The remaining 11 percent was associated with IDW disposal and support equipment costs.

**Table 8-4. Vibrocorer Cost Summary for S1A1 (River Mouth)**

Item	Quantity	Unit Cost (\$)	Total Cost (\$)
Sampler			
Vibrocorer	1 unit	24,500	24,500
Core tubes <sup>a</sup>	5 units	25	125
Labor	6 hours	34	204
IDW disposal	1 55-gallon drum	182	182
Support equipment			
A-frame and winches	1 unit	3,500	3,500
Drill	1 unit for 1 day	12	12
Saw	1 unit for 1 day	15	15
<b>Total<sup>b</sup></b>			<b>\$28,540</b>

Notes:

IDW = Investigation-derived waste

<sup>a</sup> Consumable supplies

<sup>b</sup> The total dollar amount is rounded to the nearest \$10.

## 8.4 Vibrocorer Costs

This section presents information on sampler, labor, IDW disposal, and support equipment costs for the Vibrocorer as well as a summary of these costs. Table 8-4 presents these costs.

### 8.4.1 Sampler Cost

The Vibrocorer purchase cost was approximately \$24,500. Also, 4-inch-diameter, 10-foot-long, plastic core tubes were required for sample collection. During the demonstration, five tubes were used, and the purchase cost of each tube was \$25. The total sampler cost was estimated to be \$24,625. Because the Vibrocorer's purchase cost is relatively high and because the Vibrocorer is not available for rental, the Vibrocorer should be considered for sediment sampling only when the sampling program is expected to be of long duration, which will allow recovery of the sampler purchase cost.

### 8.4.2 Labor Cost

The time required for sampler setup, sample collection, sampler disassembly, and sampler decontamination totaled 142 minutes or about 2.5 hours for each of two technicians. In addition, one technician spent about 1 hour preparing core catchers at an off-site location. In S1A1, five investigative samples each were collected in the 0- to 4- and 6- to 12-inch bss depth intervals using the Vibrocorer. Table 4-3 presents additional information on the total number of samples collected. The labor cost for sampling was estimated to be \$204.

### 8.4.3 IDW Disposal Cost

Sampling in S1A1 generated IDW consisting of 45 L of unused sediment and five plastic core tubes. The total volume of IDW generated was less than 55 gallons. The cost for disposal of one 55-gallon drum of nonhazardous waste is \$182.

### 8.4.4 Support Equipment Cost

Support equipment costs for the Vibrocorer included a purchase price of \$3,500 for an A-frame and two electric (12-volt direct current) winches with steel cable for raising and lowering the sampler; a 1-day rental cost of \$12 for one portable drill (Cincy Tool Rental 1999); and a 1-day

rental cost of \$15 for one portable circular saw (Falls Tool Rental 1999). Two 3/4-inch socket wrenches, each costing less than \$10, were also used. The total cost of the support equipment was estimated to be \$3,527.

### 8.4.5 Summary of Vibrocorer Costs

In summary, for the Vibrocorer, the costs to collect the number of samples listed in Table 4-3 for the top two depth intervals in S1A1 were estimated to be \$28,540. This economic analysis shows that most of the total cost was associated with sampler purchase (86 percent). The remaining 14 percent was associated with labor, IDW disposal, and support equipment costs.

## 8.5 Comparison of Economic Analysis Results

The costs for each sampler used in S1A1 and S2A1 are summarized in Table 8-5. For S1A1, the total costs for the Russian Peat Borer were 90 percent less than the costs for the reference sampler, the Vibrocorer. This difference was due mainly to the costs involved in purchasing the samplers. However, costs that were dependent on the number of samples collected or the amount of time required (which is itself dependent on the number of samples collected), such as labor and support equipment costs, were also higher for the Vibrocorer. In addition, of the two samplers, only the Russian Peat Borer collected samples in the 4- to 6-foot bss depth interval in S1A1; the Vibrocorer's sampling costs would likely have been higher if it had collected samples in this interval because of greater sample collection times and possibly higher IDW disposal costs.

For S2A1, the total costs for the Russian Peat Borer were 22 percent more than the costs for the reference sampler, the Hand Corer. This difference was mainly the result of higher purchase costs for the Russian Peat Borer. Two different Russian Peat Borer models were used during the demonstration to minimize the volume of IDW generated. Minimization of IDW volume did not impact the cost of IDW disposal because no cost benefit is realized when the volume is less than the capacity of one 55-gallon drum. However, if a larger number of samples were to be collected, the volume of IDW generated would increase and could become more significant. If only one Russian Peat Borer model were used, sampler costs would be significantly reduced, but the impact on sample collection time is difficult to estimate.

**Table 8-5. Comparison of Costs for Russian Peat Borer and Reference Samplers**

Item	S1A1 (River Mouth)		S2A1 (Lake)	
	Russian Peat Borer	Vibrocorer	Russian Peat Borer	Hand Corer
Sampler	\$2,405	\$24,625	\$2,960	\$1,562
Labor	51	204	85	803
IDW Disposal	182	182	182	182
Support Equipment	95	3,527	30	120
<b>Total<sup>a</sup></b>	<b>\$2,730</b>	<b>\$28,540</b>	<b>\$3,260</b>	<b>\$2,670</b>

Notes:

IDW = Investigation-derived waste

<sup>a</sup> Each total dollar amount is rounded to the nearest \$10.

## Chapter 9

### Summary of Demonstration Results

As discussed throughout this ITVR, the Russian Peat Borer was demonstrated at two sites in EPA Regions 1 and 5. At the Region 1 site, the Russian Peat Borer was demonstrated in two areas: a lake (S2A1) and a wetland (S2A2). At the Region 5 site, the Russian Peat Borer was also demonstrated in two areas: a river mouth (S1A1) and a freshwater bay (S1A2). Collectively, the four areas provided a variety of sampling conditions such as different water depths, sediment types, sediment contaminant characteristics, and sediment thicknesses necessary to properly evaluate the sampler. Based on the predemonstration investigation results, demonstration objectives, and site support facilities available, (1) the Hand Corer was selected as the reference sampler for S1A2, S2A1, and S2A2, and (2) the Vibrocorer was selected as the reference sampler for S1A1.

This chapter compares the performance and cost results for the Russian Peat Borer with those for the reference samplers. Tables 9-1 and 9-2 summarize the demonstration results for the primary and secondary objectives, respectively. As shown in these tables, the Russian Peat Borer was the only sampler that was able to collect samples in the deep depth interval (4 to 11 feet bss). Key demonstration findings are summarized below for the primary and secondary objectives.

#### 9.1 Primary Objectives

Key demonstration findings are summarized below for primary objectives P1 through P7.

- P1. In the shallow depth interval (0 to 4 inches bss), to collect a specified number of samples, the Russian Peat Borer required 33 percent more attempts than expected (65 actual versus 49 expected), whereas the reference samplers required 14 percent more attempts than expected (49 actual versus 43 expected).
- P1. In the moderate depth interval (4 to 32 inches bss), the Russian Peat Borer required 21 percent more attempts than expected (46 actual versus 38 expected), but the reference samplers required 156 percent more attempts than expected (64 actual versus 25 expected).
- P1. For the shallow depth interval, mean PSRs ranging from 71 to 84 were achieved by the Russian Peat Borer, whereas the reference samplers' mean PSRs ranged from 85 to 100. The variation in PSRs as measured by their RSDs ranged from 26 to 42 percent for the Russian Peat Borer, whereas the reference samplers' RSDs ranged from 0 to 33 percent.
- P1. For the moderate depth interval, mean PSRs ranging from 75 to 101 were achieved by the Russian Peat Borer, whereas the reference samplers' mean PSRs ranged from 21 to 82. The RSDs for the Russian Peat Borer ranged from 6 to 31 percent, whereas the reference samplers' RSDs ranged from 3 to 161 percent.
- P2. For the shallow depth interval, the Russian Peat Borer's actual core lengths equaled the target core length in 98 percent of the total sampling attempts. The reference samplers' actual core lengths equaled the target core length in 94 percent of the total sampling attempts. However, the results for the samplers were significantly different for the moderate depth interval: 93 percent for the Russian

**Table 9-1. Summary of Results for Primary Objectives**

Primary Objective	Evaluation Criterion	Sampling Depth Interval/ Demonstration Area <sup>a</sup>	Performance Results	
			Russian Peat Borer	Reference Sampler <sup>b</sup>
P1 Ability to consistently collect a specified volume of sediment	Actual versus expected number of sampling attempts	Shallow (0 to 4 inches bss)/S1A1, S1A2, and S2A1	65 actual attempts versus 49 expected attempts (33% more than expected)	49 actual attempts versus 43 expected attempts (14% more than expected)
		Moderate (4 to 32 inches bss)/S1A1, S1A2, S2A1, and S2A2	46 actual attempts versus 38 expected attempts (21% more than expected)	64 actual attempts versus 25 expected attempts (156% more than expected)
		Deep (4 to 11 feet bss)/S1A1 and S2A2	15 actual attempts versus 8 expected attempts (88% more than expected)	Unable to collect samples <sup>c</sup>
	Volume of sediment sampled versus design volume	Shallow (0 to 4 inches bss)/S1A1, S1A2, and S2A1	Mean PSRs: 71 to 84 RSDs of PSRs: 26 to 42%	Mean PSRs: 85 to 100 RSDs of PSRs: 0 to 33%
		Moderate (4 to 32 inches bss)/S1A1, S1A2, S2A1, and S2A2	Mean PSRs: 75 to 101 <sup>d</sup> RSDs of PSRs: 6 to 31%	Mean PSRs: 21 to 82 RSDs of PSRs: 3 to 161%
		Deep (4 to 11 feet bss)/S1A1 and S2A2	Mean PSRs: 45 and 122 <sup>d</sup> RSDs of PSRs: 71 and 16%	Unable to collect samples <sup>c</sup>
P2 Ability to consistently collect sediment in a specified depth interval	Number of sampling attempts in which actual core length equaled target core length	Shallow (0 to 4 inches bss)/S1A1, S1A2, and S2A1	64 of 65 attempts (98%)	46 of 49 attempts (94%)
		Moderate (4 to 32 inches bss)/S1A1, S1A2, S2A1, and S2A2	43 of 46 attempts (93%)	8 of 64 attempts (13%)
		Deep (4 to 11 feet bss)/S1A1 and S2A2	4 of 15 attempts (27%)	Unable to collect samples <sup>c</sup>
P3 Ability to collect samples with consistent characteristics from a homogenous layer of sediment	Variability of sample characteristics in terms of PSD	0 to 4 inches bss/S2A1	Sand: 26 to 35% Silt: 48 to 66% Clay: 2 to 8%	Sand: 26 to 46% Silt: 48 to 72% Clay: 0 to 5%
		10 to 30 inches bss/S2A1	Sand: 34 to 37% Silt: 57 to 62% Clay: 2 to 9%	Sand: 35 to 43% Silt: 53 to 62% Clay: 0 to 4%
		12 to 32 inches bss/S1A2	Sand: 1% Silt: 73 to 82% Clay: 17 to 26%	Sand: 3 to 6% Silt: 63 to 72% Clay: 22 to 31%
P4 Ability to collect a representative sample from a clean sediment layer below a contaminated sediment layer	Mean difference between innovative and reference sampler arsenic concentrations for clean layer is zero	10 to 30 inches bss/S2A1	According to the Wilcoxon signed rank test, there was a 61 percent probability that the innovative and reference sampler arsenic concentrations were not different.	
P5 Ability to be adequately decontaminated	Contaminant concentrations in equipment rinsate samples are below reporting limits	Objective addressed by area: one PCB-contaminated area (S1A1) and one arsenic-contaminated area (S2A1)	The contaminant concentrations in the equipment rinsate samples for the Russian Peat Borer and reference samplers were below the reporting limits (1 part per billion for PCBs and 10 parts per billion for arsenic).	

**Table 9-1. Summary of Results for Primary Objectives (Continued)**

Primary Objective	Evaluation Criterion	Sampling Depth Interval/ Demonstration Area <sup>a</sup>	Performance Results	
			Russian Peat Borer	Reference Sampler <sup>b</sup>
P6 Time requirements for sample collection activities	Total time required for sampler setup, sample collection, sampler disassembly, and sampler decontamination	Objective addressed by area: S1A1	88 minutes <sup>e</sup>	142 minutes <sup>e</sup>
		Objective addressed by area: S1A2	12 minutes	53 minutes
		Objective addressed by area: S2A1	149 minutes	594 minutes
		Objective addressed by area: S2A2	138 minutes <sup>f</sup>	165 minutes <sup>f</sup>
P7 Sampling costs	Total cost, including sampler, labor, IDW disposal, and support equipment costs	Objective addressed by area: S1A1	\$2,730 <sup>e</sup>	\$28,540 <sup>e</sup>
		Objective addressed by area: S2A1	\$3,260	\$2,670

Notes:

- |                                   |                                   |
|-----------------------------------|-----------------------------------|
| bss = Below sediment surface      | RSD = Relative standard deviation |
| IDW = Investigation-derived waste | S1A1 = River mouth                |
| PCB = Polychlorinated biphenyl    | S1A2 = Freshwater bay             |
| PSD = Particle size distribution  | S2A1 = Lake                       |
| PSR = Percent sample recovery     | S2A2 = Wetland                    |

- <sup>a</sup> Based on the PSD results, the shallow depth interval contained silty sand in S1A1, predominantly sand and silt with some clay in S1A2, and sandy silt in S2A1. The moderate depth interval contained sandy silt in both S1A1 and S2A1, clayey silt in S1A2, and predominantly silt with some sand and clay in S2A2. Also, in S2A2, the (1) shallow and moderate depth intervals contained significant amounts of partially decomposed reeds and leaves and live vegetation and (2) deep depth interval contained peat. The sediment in the deep depth interval was not analyzed for PSD.
- <sup>b</sup> The Hand Corer was used as the reference sampler in S1A2, S2A1, and S2A2. The Vibrocorer was used as the reference sampler in S1A1.
- <sup>c</sup> The Hand Corer is not designed to collect samples in the deep depth interval. The Vibrocorer was unable to collect samples below 5 feet bss because of the presence of clay hardpan in S1A1.
- <sup>d</sup> PSRs exceeding 100 resulted from the volumetric measurement error associated with the presence of void spaces when the sediment was transferred to a graduated container.
- <sup>e</sup> In S1A1, the Russian Peat Borer collected samples in all three depth intervals (shallow, moderate, and deep), but the reference sampler collected samples in only the shallow and moderate depth intervals.
- <sup>f</sup> In S2A2, the Russian Peat Borer collected samples in both depth intervals (moderate and deep), but the reference sampler collected samples in only the moderate depth interval.



**Table 9-2. Summary of Results for Secondary Objectives**

Secondary Objective	Performance Results		
	Russian Peat Borer	Reference Sampler <sup>a</sup>	
		Hand Corer	Vibrocorer
S1 Skills and training requirements for proper sampler operation	<ul style="list-style-type: none"> <li>• Easy to operate; requires minimal skills and training</li> <li>• Can be operated by one person because of its lightness and because it has only one moving part</li> </ul>	<ul style="list-style-type: none"> <li>• Easy to operate; requires minimal skills and training</li> <li>• Can be operated by one person when up to two extension rods are used; two persons and a tripod-mounted winch are recommended when more extension rods are used</li> </ul>	<ul style="list-style-type: none"> <li>• Relatively complicated to operate; requires moderate skills and training</li> <li>• Requires two persons and a motor-operated winch because of the heaviness of the sampler (about 150 lb)</li> </ul>
S2 Ability to collect samples under a variety of site conditions	<ul style="list-style-type: none"> <li>• Collected samples in a river mouth (S1A1), freshwater bay (S1A2), lake (S2A1), and wetland (S2A2) where water depths ranged from 0.5 foot to 18 feet</li> <li>• Collected samples in shallow (0- to 4-inch bss), moderate (4- to 32-inch bss), and deep (4- to 11-foot bss) depth intervals</li> <li>• Collected samples from a variety of sampling platforms: wooden planks fastened to ladders, a Jon boat, a pontoon boat, and the EPA GLNPO's <i>Mudpuppy</i></li> </ul>	<ul style="list-style-type: none"> <li>• Collected samples in a freshwater bay (S1A2), lake (S2A1), and wetland (S2A2) where water depths ranged from 0.5 foot to 18 feet</li> <li>• Collected samples in shallow (0- to 4-inch bss) and moderate (4- to 32-inch bss) depth intervals; sampler is not designed to collect samples in depth intervals below 3 feet bss</li> <li>• Collected samples from a variety of sampling platforms: wooden planks fastened to ladders, a Jon boat, and a pontoon boat</li> <li>• Material caught between core tube and flutter valve could cause partial or complete loss of sample</li> </ul>	<ul style="list-style-type: none"> <li>• Collected samples in a river mouth (S1A1) where water depths ranged from 5 to 6 feet</li> <li>• Collected samples in shallow (0- to 4-inch bss) and moderate (4- to 32-inch bss) depth intervals but was unable to penetrate clay hardpan in order to collect samples in 4- to 6-foot bss depth interval</li> <li>• Collected samples from the EPA GLNPO's <i>Mudpuppy</i></li> </ul>
S3 Ability to collect an undisturbed sample	<ul style="list-style-type: none"> <li>• Collected discrete, relatively uncompressed, representative core samples of consolidated sediment, based on visual observations</li> <li>• Sediment stratification preserved for consolidated sediment but not for unconsolidated sediment</li> <li>• Material caught between core tube and cover plate could prevent complete closure of core tube, resulting in partial or complete washout of unconsolidated sediment</li> </ul>	<ul style="list-style-type: none"> <li>• Collected relatively compressed core samples of both unconsolidated and consolidated sediments from the sediment surface downward, based on visual observations</li> <li>• Sediment stratification preserved for both unconsolidated and consolidated sediments</li> <li>• Samples collected in and below moderate depth interval may be of questionable representativeness because of core shortening and core compression; sampler is not designed to collect samples in depth intervals below 3 feet bss</li> </ul>	<ul style="list-style-type: none"> <li>• Collected relatively compressed core samples of both unconsolidated and consolidated sediments from the sediment surface downward, based on visual observations</li> <li>• Sediment stratification preserved for both unconsolidated and consolidated sediments</li> <li>• Samples collected in moderate and deep depth intervals may be of questionable representativeness because of core shortening and core compression</li> </ul>

**Table 9-2. Summary of Results for Secondary Objectives (Continued)**

Secondary Objective	Performance Results		
	Russian Peat Borer	Reference Sampler <sup>a</sup>	
		Hand Corer	Vibrocorer
S4 Durability based on materials of construction and engineering design	<ul style="list-style-type: none"> <li>• Sampler is sturdy; its primary components are made of stainless steel and Delrin®</li> <li>• Aluminum extension rods are rigid and float; no bending or bowing was observed when rods were coupled to a total length of 21 feet</li> <li>• During sample collection in 9- to 11-foot bss depth interval in S2A2, excessive stress associated with sampling caused a few rivets on one extension rod to gradually come loose</li> </ul>	<ul style="list-style-type: none"> <li>• Sampler is sturdy; most of its primary components are made of stainless steel</li> <li>• Galvanized extension rods are rigid; minimal bending or bowing was observed when rods were coupled to a total length of 25 feet</li> <li>• During sample collection in S2A1, where water depth was about 18 feet, the pontoon boat drifted; the resulting stress damaged one extension rod at the threads</li> </ul>	<ul style="list-style-type: none"> <li>• Sampler is sturdy; its primary component, the vibrohead, is made of anodized aluminum and has a life expectancy of 10,000 operating hours</li> <li>• During sample collection in S1A1, the power supply for the sampler malfunctioned; the source of the malfunction was identified and corrected by on-site personnel</li> </ul>
S5 Availability of sampler and spare parts	<ul style="list-style-type: none"> <li>• Sampler and its support equipment are not expected to be available in local retail stores but may be obtained from technology developer by overnight courier in 2 days or less, depending on the location of the sampling site</li> </ul>	<ul style="list-style-type: none"> <li>• Primary components of sampler are not expected to be available in local retail stores but may be obtained from technology developer by overnight courier in 2 days or less, depending on the location of the sampling site; extension rods are expected to be available in local retail stores</li> </ul>	<ul style="list-style-type: none"> <li>• Primary sampler component, the vibrohead, is not available in local retail stores; because the vibrohead is pressure-sealed, if it malfunctions, it should be packaged and shipped to the developer for servicing</li> </ul>

Notes:

- bss = Below sediment surface
- EPA = U.S. Environmental Protection Agency
- GLNPO = Great Lakes National Program Office

<sup>a</sup> The Hand Corer was used as the reference sampler in S1A2, S2A1, and S2A2. The Vibrocorer was used as the reference sampler in S1A1.

Peat Borer compared to 13 percent for the reference samplers.

- P3. Based on the PSD results, both the Russian Peat Borer and reference samplers collected samples with consistent physical characteristics from a homogenous layer of sediment.
- P4. The Russian Peat Borer collected samples from a clean sediment layer below a contaminated sediment layer that were at least as representative as the samples collected from the clean layer by the reference sampler (the Hand Corer); contaminant concentrations in the samples collected by both samplers were not statistically different at a significance level of 0.05.
- P5. Both the Russian Peat Borer and reference samplers demonstrated the ability to be adequately decontaminated after sampling in areas contaminated with either PCBs or arsenic.
- P6. Compared to the reference samplers, the Russian Peat Borer not only was able to collect samples in all depth intervals and areas but also reduced sampling time by 16 to 77 percent, depending on the area.
- P7. Sampling costs were estimated for two of the four areas sampled. In one area, the sampling costs for the Russian Peat Borer were 90 percent less than those for the reference sampler (the Vibrocorer); in the other area, the sampling costs for the Russian Peat Borer were 22 percent more than those for the reference sampler (the Hand Corer).

## 9.2 Secondary Objectives

Key demonstration findings are summarized below for secondary objectives S1 through S5.

- S1. The Russian Peat Borer, like the Hand Corer, is easy to operate and requires minimal skills and training. However, operation of the Vibrocorer is relatively complicated and requires moderate skills and training.
- S1. The Russian Peat Borer was operated by one person, whereas the Hand Corer was operated by one or two persons and the Vibrocorer was operated by two

persons. In addition, when more than two extension rods were required, the Hand Corer was operated using a tripod-mounted winch. Also, the Vibrocorer operation required a motor-operated winch, whereas the Russian Peat Borer was operated without a winch throughout the demonstration.

- S2. The Russian Peat Borer collected samples in all depth intervals and demonstration areas. The reference samplers were unable to collect samples in deep depth intervals (4 to 11 feet bss).
- S2. Neither the Russian Peat Borer nor the Hand Corer requires a power supply. In contrast, the Vibrocorer requires a three-phase, 230- or 440-volt, 50- to 60-hertz power supply, which is a sampler limitation if the power supply fails.
- S3. The Russian Peat Borer collected representative core samples of consolidated sediment in discrete depth intervals. Visual observations indicated that these samples were relatively uncompressed. The reference samplers collected relative compressed core samples of both consolidated and unconsolidated sediments from the sediment surface downward. In addition, in moderate and deep depth intervals, samples collected by the reference samplers may be of questionable representativeness because of core shortening and core compression.
- S3. In the samples collected by the Russian Peat Borer, sediment stratification was preserved for consolidated sediment but not for unconsolidated sediment. Sediment stratification was preserved for both consolidated and unconsolidated sediments in the samples collected by the reference samplers.
- S4. Based on their materials of construction and engineering designs, both the Russian Peat Borer and reference samplers are considered to be sturdy.
- S5. The Russian Peat Borer and its support equipment are not expected to be available in local retail stores. Similarly, the primary components of the Hand Corer and Vibrocorer are not expected to be available in local retail stores; extension rods for the Hand Corer may be locally available.

## Chapter 10 References

- Aaby, B., and G. Digerfeldt. 1986. "Sampling Techniques for Lakes and Bogs." Chapter 8 in *Handbook of Holocene Palaeoecology and Palaeohydrology*. B.E. Berglund, Editor. John Wiley & Sons, New York.
- Analytical Software. 1996. Statistix® for Windows. Version 2.0. Tallahassee, Florida.
- ASTM. 1998. "ASTM Standards in Building Codes." Volume 3. C 962-D 2940.
- Belokopytov, I.E., and V.V. Beresnevich. 1955. "Giktorf's Peat Borers." *Torfyanaya Promyfhlennost*. Number 8. Pages 9 and 10.
- Blomqvist, S. 1991. "Quantitative Sampling of Soft-Bottom Sediments: Problems and Solutions." *Marine Ecology Progress Series*. Volume 72. Pages 295 through 304.
- Cincy Tool Rental. 1999. "Electric Tools." On-Line Address: <http://www.cincytool.com/cgi-bin/hackmail4.cgi?electric>. Accessed on August 4.
- Downing, J.A. 1984. "Sampling the Benthos of Standing Waters." Chapter 4 in *Manual on Methods for the Assessment of Secondary Productivity in Fresh Waters*. J.A. Downing and F.H. Rigler, Editors. Blackwell Scientific Publications. Oxford, England.
- Environment Canada. 1994. "Guidance Document on Collection and Preparation of Sediment for Physicochemical Characterization and Biological Testing." Environmental Protection Series. Report EPS 1/RM/29. December.
- EPA. 1996. "Test Methods for Evaluating Solid Waste." Volumes 1A through 1C. SW-846. Third Edition. Update III. OSWER. Washington, DC. December.
- EPA. 1999. "Sediment Sampling Technologies Demonstration Plan." ORD. Washington, DC. April.
- Faegri, K., and J. Iversen. 1989. *Textbook of Pollen Analysis*. Knut Faegri, Peter Emil Kaland, and Knut Krzywinski, Editors. Fourth Edition. Pages 60 through 63.
- Falls Tool Rental. 1999. "Power Tool Rental Rates." On-Line Address: <http://www.fallstoolrental.com/powertools.html>. Accessed on August 4.
- Gilbert, R. 1987. *Statistical Methods for Environmental Pollution Monitoring*. Van Nostrand Reinhold Company, Inc. New York.
- Hazco. 1999. *Equipment Management Program Price List*. Dayton, Ohio.
- Jowsey, P.C. 1966. "An Improved Peat Sampler." *New Phytologist*. Volume 65. Pages 245 through 248.
- Means. 1999. *Environmental Remediation Cost Data—Unit Price*. Kingston, Massachusetts.
- Tetra Tech. 1999a. Record of Telephone Conversation Regarding Sampler Costs. Between Amy Stephen, Environmental Engineer, and Will Young, President and Owner, ARI. August 9.

---

Tetra Tech. 1999b. Record of Telephone Conversation Regarding Delrin®. Between Eric Monschein, Environmental Scientist, and DuPont Technical Support Staff. August 10.

Tetra Tech. 1999c. "Sediment Sampling Technologies Data Evaluation Report." Prepared for ORD, EPA. October.

## Appendix A Developer's Claims for the ARI Russian Peat Borer

This appendix was written to comment on ARI's recent participation in the EPA SITE demonstration of the Russian Peat Borer. First, ARI would like to extend its thanks to the EPA and Tetra Tech for a job well done. As a technology developer and business owner, ARI cannot stress enough the importance of such verification programs in its efforts to simplify current sediment sampling methods. ARI hopes the information herein can help field technicians choose a proper sediment sampler, understand the demonstration sampling problems encountered, and be aware of options available for use with the Russian Peat Borer.

ARI constructs several sediment sampling devices that fall into two basic groups: side-filling, chambered samplers and end-filling, core tube samplers. Customers often ask ARI to compare and contrast these two groups in order to select the best sampler for a specific sampling scenario. Below are some important points to consider when a sediment sampler is chosen.

### 1. ARI Russian Peat Borer, a Side-Filling, Chambered Sampler

#### Advantages

- Simple design: the ARI Russian Peat Borer contains one moving part.

- Quality of samples: the close-open-close design produces uncompressed and undisturbed samples with a quality rivaled only by freeze-coring techniques.
- Discrete point sampling: the sampler is capable of recovering intact, consecutive core profiles to a depth of 100 feet bss.
- Versatility: the ARI Russian Peat Borer was the only sampler participating in the demonstration to collect samples in all areas and target depth intervals identified in the demonstration plan. The Russian Peat Borer has been successfully used in wetlands, bogs, lakes, and estuaries.
- History: the sampler has been used extensively for detailed paleoecological analyses including studies of microfossil sequencing, annual laminations, and paleomagnetism.
- Time: ARI Russian Peat Borer samples can be recovered and sectioned in a fraction of the time required for samples collected using end-filling, core samplers. Collected material is available for immediate inspection, sectioning, and archiving.
- Cost: a complete ARI Russian Peat Borer is priced competitively as compared to most core

Appendix A was written solely by ARI. The statements presented in this appendix represent the developer's point of view and summarize the claims made by the developer regarding the ARI Russian Peat Borer. Publication of this material does not represent the EPA's approval or endorsement of the statements made in this appendix; performance assessment and economic analysis results for the ARI Russian Peat Borer are discussed in the body of this ITVR.



samplers meeting similar depth and volume requirements.

- Portability: the ARI Russian Peat Borer is lightweight, ergonomic, and suitable for one-person operation on a small sampling platform. Minimal training or support equipment is required for its operation.

Disadvantages

- Sampler operation: the ARI Russian Peat Borer is limited to deployment on extension rods to a maximum depth of 100 feet bss.
- Cross-contamination: the sampler’s cover plate (fin) is exposed to sediments in various horizons during deployment. Deposits near the cover plate must be suspected of contamination and discarded. However, the rest of the sample can be used for analysis. Gross decontamination of the sampler is required to reduce cross-contamination between samples.
- Coupling and uncoupling extension rods: this process may be difficult after the threaded couplers are tightened by the twisting action of the sampler in compact sediment.

2. ARI End-Filling, Core Samplers (Gravity Corers, Percussion Corers, and Piston Corers)

Advantages

- The samplers allow transportation and preservation of intact core samples.
- The samplers allow precise, incremental core extruding and sectioning.
- The samplers allow *in vitro* incubations to assess biochemical oxygen demand, benthic carbon, and methane and ammonia diagenesis.

- The samplers allow pressurized core squeezing and pore water sampling.

Disadvantages

- Piston corers can recover discrete samples only under certain conditions and with considerable difficulty.
- Core shortening may occur. Inferior sample quality and possible intermittent sampling may lead to serious misinterpretations of sediment stratification and contaminant concentrations.
- Sample smearing and swirling may occur as a result of use of core catchers.
- Cross-contamination may occur, particularly during core extrusion. Deposits near the core tube wall must be suspected of contamination and discarded.
- Expendables are costly.

During the demonstration, S2A2 presented several interesting sampling problems because of its very compact wetland deposits. Three intact, consecutive sediment profiles were recovered in the 9- to 11-foot bss depth interval before sampling was terminated because of partial extension rod failure and excessive work requirements for sampler deployment. Both of these problems were associated with stress created by slide-hammering, particularly upon retrieval of the sampler from compact sediment.

ARI deep-water extension rods (see below) were employed in all demonstration areas because they are lightweight and ergonomic. They are moderately priced and particularly well suited for intensive sampling at deep sites. After three of five samples were recovered in the 9- to 11-foot bss depth interval in S2A2, ARI noticed that the stainless-steel rivets used to fasten internal, threaded bushings to the aluminum extensions began to distort and

Appendix A was written solely by ARI. The statements presented in this appendix represent the developer’s point of view and summarize the claims made by the developer regarding the ARI Russian Peat Borer. Publication of this material does not represent the EPA’s approval or endorsement of the statements made in this appendix; performance assessment and economic analysis results for the ARI Russian Peat Borer are discussed in the body of this ITVR.

dislodge because of excessive upward forces created by the slide-hammer mechanism. Also, considerable twisting force was applied to rotate the core tube 180 degrees (to the closed position), which probably contributed to rivet failure. The rivets were reset, and the rods performed well at the remaining sampling sites. Use of ARI magnesium-zirconium extension rods (see below) would be necessary for intensive sampling of the compact deposits found in S2A2.

Use of proper extension rods is a key element when employing the ARI Russian Peat Borer, and care must be taken when the rods are chosen. When sampling deep or compact deposits, one should be prepared to pay a premium price for extension rods that are designed to endure such conditions. Heavy pounding with a slide-hammer, particularly during retrieval, puts tremendous stress on threaded couplers. Also, the clockwise turning of the core tube in dense material requires considerable force, thus tightening the threaded couplers. As a result, uncoupling may require use of pipe and strap wrenches. Listed below are several types of extension rods currently available for deploying the ARI Russian Peat Borer.

#### 1. ARI Standard Extension Rods

- Aluminum hollow bar construction: 2.5 centimeters (cm) in diameter with 7/8-inch-diameter, stainless-steel, coarse-threaded couplers
- Standard lengths: 1.0 and 2.0 meters (m)
- Function and advantages: general sampling of lakes, wetlands, and bogs at shallow depths; suitable for moderately compact sediments
- Maximum sampling depth: 33 feet bss
- Cost: \$45 per 1-m length

#### 2. ARI Deep-Water Extension Rods

- Aluminum hollow bar construction: 4.2 cm in diameter with 7/8-inch-diameter, stainless-steel, coarse-threaded couplers
- Standard lengths: 1.0, 2.0, 3.0, and 6.0 m
- Function and advantages: deeper water deployments; lightweight, buoyant, larger diameter for easy turning without "T"-handle, increased rigidity, suitable for moderate slide-hammer deployments, suitable for moderately compact sediments
- Maximum sampling depth: 67 feet bss
- Cost: \$75 per 1-m length

#### 3. ARI Magnesium-Zirconium Extension Rods

- Magnesium-zirconium hollow bar construction: 4.5 cm in diameter with machined, coarse-threaded, acme-type couplers; rods couple together in approximately four revolutions
- Standard length: 2.0 m
- Function and advantages: deep water sampling, suitable for heavy slide-hammer deployments, cold weather sampling (through ice), suitable for very compact sediments, suitable for extreme duty; rigidity, easy coupling and uncoupling
- Maximum sampling depth: 100 feet bss
- Cost: \$110 per 1-m length

Appendix A was written solely by ARI. The statements presented in this appendix represent the developer's point of view and summarize the claims made by the developer regarding the ARI Russian Peat Borer. Publication of this material does not represent the EPA's approval or endorsement of the statements made in this appendix; performance assessment and economic analysis results for the ARI Russian Peat Borer are discussed in the body of this ITVR.

Considerable work was required to recover samples in the 9- to 11-foot bss depth interval in S2A2. The slide-hammer mechanism was undersized (10 lb, 50 cm in height) and insufficient for sampling the compact sediment in this interval. Simple modifications, including increasing the weight and height of the assembly, may aid in driving and removing the sampler under similar conditions. Winches and electric rotary hammers are workable options but are unnecessary in most applications.

Soft, organic sediment encountered in S2A1 also presented some interesting problems with respect to sampling the water-sediment interface. The ARI Russian Peat Borer is a side-filling, chambered-type sampler that mechanically retains sediment in the core tube upon retrieval. A very thin slot that is present between the cover plate and core tube to allow free rotation of the core

tube may cause some leaking and washout of interface samples. Of course, the best way to avoid this problem is to deploy the sampler deeper and minimize collection of water at the interface. An option derived from the literature is installation of a watertight, rubber “wiper seal” on the cover plate, which could reduce leaking.

Since 1986, ARI has been proud to be involved in hundreds of sediment sampling projects in over 35 countries. Based on experience and good advice from customers, ARI focuses on two matters with regard to sediment samplers: simplicity and sample quality. Considering the time and money spent on sample analyses, it is clear that recovery of clean, uncompressed, undisturbed sediment samples is essential to any investigation using sediment for depositional and historical reconstruction.

Appendix A was written solely by ARI. The statements presented in this appendix represent the developer’s point of view and summarize the claims made by the developer regarding the ARI Russian Peat Borer. Publication of this material does not represent the EPA’s approval or endorsement of the statements made in this appendix; performance assessment and economic analysis results for the ARI Russian Peat Borer are discussed in the body of this ITVR.

## Appendix B

### Performance and Cost of the Ekman Grab

The EPA conducted a demonstration of an innovative sediment sampler known as the Russian Peat Borer, a core sampler designed and fabricated by ARI of Lemhi, Idaho. The demonstration was conducted under the EPA SITE Program at two sites during the last week of April and first week of May 1999. The purpose of this demonstration was to obtain reliable performance and cost data on the Russian Peat Borer in order to (1) achieve a better understanding of the sampler's capabilities relative to conventional sediment samplers and (2) provide an opportunity for the sampler to enter the marketplace and compete with conventional samplers without long delays.

In addition to the Russian Peat Borer and the reference samplers, a conventional grab sampler was included in the demonstration because grab samplers are commonly used to collect surficial sediment in order to assess the horizontal distribution of sediment characteristics. The Ekman Grab, a commonly used sampler, was chosen for the demonstration. Performance and cost data collected for the Ekman Grab are not intended to be compared to those for the Russian Peat Borer but rather are presented in this appendix as supplemental information.

Specifically, this appendix describes the Ekman Grab that was demonstrated (Section B.1), two demonstration sites (Section B.2), demonstration approach (Section B.3), performance of the Ekman Grab (Section B.4), and references used to prepare this appendix (Section B.5).

#### **B.1 Description of the Ekman Grab**

The Ekman Grab is a "box" sampler whose bottom end collects sediment as the sampler penetrates the sediment. The sampler is designed to collect samples of soft, finely divided sediment that is free of vegetation, stones, and

other coarse debris. A technical description, general operating procedures, and advantages and limitations of the Ekman Grab are presented below.

##### ***B.1.1 Sampler Description***

Components of the Ekman Grab selected for the demonstration included (1) two stainless-steel scoops; (2) two stainless-steel springs attached to four scoop buttons; (3) two stainless-steel scoop cables; (4) a stainless-steel messenger; (5) a 3/16-inch-diameter, braided, polyester line or 5-foot-long, galvanized-steel extension handle; (6) a release mechanism consisting of a stainless-steel strike pad and two stainless-steel pins; and (7) two hinged, overlapping, stainless-steel lids (see Figure B-1).

Optional accessories include a 10-foot-long extension handle and weights that can be fastened to either side of the Ekman Grab. Top screens designed to prevent sediment from escaping from the top of the Ekman Grab are also available.

In water depths up to 10 feet, the Ekman Grab can be manually deployed using the extension handle. In water up to 60 feet deep and with low velocity, the sampler can be deployed using the polyester line and messenger. During sampler deployment, the two lids at the top of the sampler open to allow water to pass through the sampler in order to minimize bow wave formation, thus minimizing disturbance of the sediment. Once the sampler is deployed to the desired sampling location, the release mechanism is actuated using the extension handle or the messenger on the polyester line. Once actuated, the mechanism releases the scoop cables, allowing the springs to close the scoops and collect a sediment sample. During

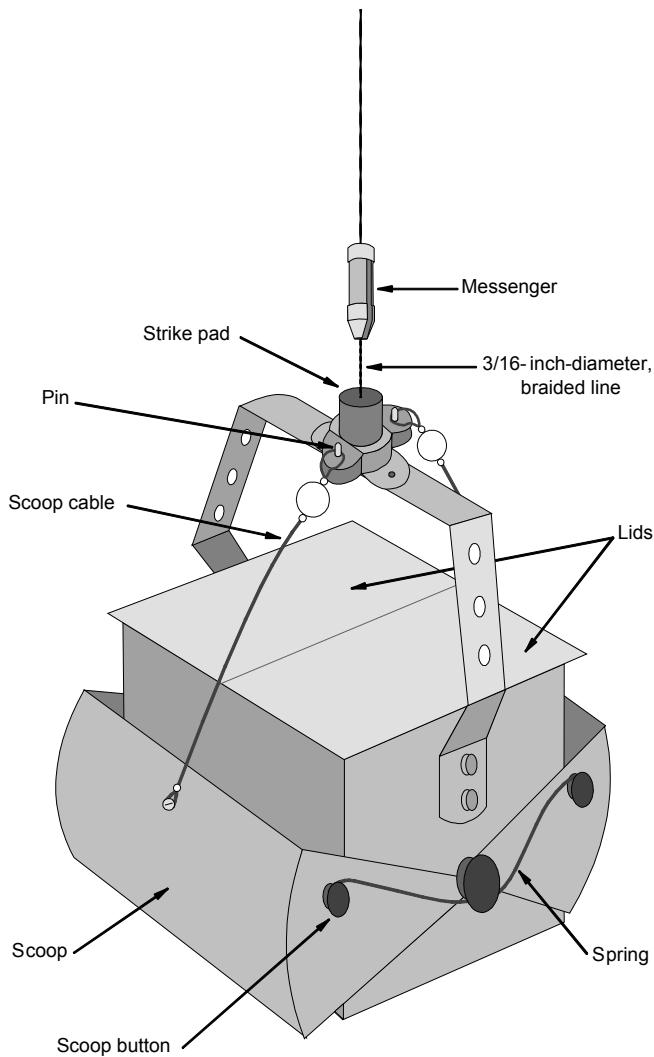

Figure B-1. Ekman Grab.

sampler retrieval, the lids automatically close to minimize sample washout.

The Ekman Grab is available in many sizes; however, for this demonstration, the standard-size Ekman Grab was chosen because of its ability to collect a sample volume that met the demonstration objectives while generating relatively little IDW. The standard-size Ekman Grab contains a 6-inch-long, 6-inch-wide, and 6-inch-high sample chamber with a volume of 3,460 mL. The area below the chamber created by the two scoops when closed constitutes an additional 630 mL. The fully assembled Ekman Grab, not including the extension handle, weighs about 10 lb.

### B.1.2 General Operating Procedures

The Ekman Grab can be manually operated by one person from a sampling platform or while wading in shallow water. Prior to sampler deployment, each of the two springs must be manually attached to the two scoop buttons on either side of the sampler. Also, before the Ekman Grab is lowered into the water, each scoop cable must be manually hooked to one of the two pins in order to hold the sampler in an open position. During and after sampler preparation for deployment, care must be used to avoid catching any body parts such as fingers or feet between the scoops.

The sampler can be manually lowered to the sediment surface using the extension handle or polyester line. In either case, the speed of sampler deployment needs to be controlled in order to avoid bow wave formation. If the polyester line is used, the sampler should not be allowed to fall freely for a significant distance. The sampler should be manually lowered to the sediment surface and then slightly raised before it is released; this procedure allows the weight of the sampler to control sediment penetration.

Once the sampler penetrates the sediment, the release mechanism is actuated using the extension handle or by placing the messenger on the polyester line and allowing it to slide down the line to the strike pad. When the strike pad is depressed, the pins are lowered, the scoop cables are released, and the springs close the scoops to collect a sediment sample. After the scoops are fully closed, the Ekman Grab should be raised slowly from the sediment and then raised steadily to the water surface.

There are several ways to process grab samples collected using the Ekman Grab. Upon removal of the sampler from the water, the grab sample may be discharged into a bucket or bowl. Another way of processing the sample is to keep the scoops closed and open the lids on top of the sampler; then small-diameter tubes can be inserted into the top portion of the sampler to collect subsamples.

### B.1.3 Advantages and Limitations

An advantage of the Ekman Grab is that it is easy to operate, requiring minimal skills and training. Sampler assembly and collection procedures can be learned in the



field with a few practice attempts. In addition, a written SOP typically accompanies the sampler when it is procured. The sampler can be operated by one person in shallow (wading) and deep water depths because of its lightness (10 lb, not including the weight of the extension handle). Sampler operation is simple because the sampler does not require complete disassembly and reassembly after each sampling attempt. Only the scoops have to be opened in order to retrieve the sediment sample. The sampler also requires no support equipment.

Another advantage of the Ekman Grab is that during sampler deployment, the two lids at the top of the sampler open to allow water to pass through the sampler and to minimize the bow wave formation, thus minimizing disturbance of the sediment. The sampler's scoops are designed to overlap in the closed position in order to minimize sample loss during sampler retrieval. In addition, the release mechanism and pivoting scoops are designed to minimize sediment disturbance when a sample is collected.

A limitation of the Ekman Grab is that because of its lightness, the sampler may not be able to penetrate consolidated sediment if the sampler is deployed by gravity penetration with a polyester line. In addition, small stones or vegetation may become caught between the scoops, causing the scoops to remain in the open position during sampler retrieval, resulting in partial or complete loss of the sample. Also, during and after sampler preparation for deployment, care must be used to avoid catching any body parts such as fingers or feet between the scoops.

## **B.2 Description of the Demonstration Sites**

The Ekman Grab was demonstrated at two sites in EPA Regions 1 and 5. At the Region 1 site, Ekman Grab sampling was conducted in one sampling area (S2A1) that represented lake conditions and had a water depth of about 18 feet. At the Region 5 site, Ekman Grab sampling was conducted in two areas. One area (S1A1) was in a river mouth and had a water depth of about 5 to 6 feet. The other area (S1A2) was in a freshwater bay along a river and had a water depth of about 2 feet.

Additional information on demonstration site and area characteristics and the sampling platforms used is provided in Chapter 3 of the ITVR.

## **B.3 Demonstration Approach**

This section presents the demonstration objectives, design, and field sampling and measurement procedures, for the Ekman Grab.

### ***B.3.1 Demonstration Objectives***

The demonstration had both primary and secondary objectives. Primary objectives were critical to the technology evaluation and were intended to produce quantitative results regarding technology performance. Secondary objectives provided information that was useful but did not necessarily produce quantitative results regarding technology performance.

As stated in Section 4.1 of the ITVR, the primary objectives for the demonstration were as follows:

- P1. Evaluate whether the sampler can consistently collect a specified volume of sediment
- P2. Determine whether the sampler can consistently collect samples in a specified depth interval
- P3. Assess the sampler's ability to collect multiple samples with consistent physical or chemical characteristics, or both, from a homogenous layer of sediment
- P4. Evaluate whether the sampler can collect a representative sample from a "clean" sediment layer that is below a contaminated sediment layer
- P5. Assess the sampler's ability to be adequately decontaminated between sampling areas
- P6. Measure the time required for each activity associated with sample collection (sampler setup, sample collection, sampler disassembly, and sampler decontamination)



P7. Estimate costs associated with sample collection activities (sampler, labor, IDW disposal, and support equipment costs)

Primary objective P4 was not addressed for the Ekman Grab because this sampler is not designed in such a way that it can be evaluated under P4. The secondary objectives for the demonstration were as follows:

- S1. Document the skills and training required to properly operate the sampler
- S2. Evaluate the sampler’s ability to collect samples under a variety of site conditions
- S3. Assess the sampler’s ability to collect an undisturbed sample
- S4. Evaluate the sampler’s durability based on its materials of construction and engineering design
- S5. Document the availability of the sampler and spare parts

### B.3.2 Demonstration Design

Samples were collected using the Ekman Grab to obtain supplemental performance and cost data. Table B-1 summarizes the demonstration design for collecting grab samples. Sediment samples were collected using the Ekman Grab only in the 0- to 4-inch bss depth intervals in S1A1, S1A2, and S2A1. The Ekman Grab is designed to collect surficial sediment samples in areas that are largely free of vegetation. According to the findings of the predemonstration investigation, most of the surficial material in S2A2 was composed of decomposed leaves and wood chips. Therefore, grab samples were not collected in S2A2. The approach for addressing the primary objectives using the Ekman Grab was generally the same as that for the Russian Peat Borer presented in Section 4.2 of the ITVR. Differences in the approach for the Ekman Grab are discussed below.

- Primary objective P1 was generally addressed as described for the Russian Peat Borer. The volume of sediment collected was noted. However, measurement of core lengths was not appropriate for the Ekman Grab and was not conducted.

**Table B-1. Ekman Grab Demonstration Design**

Demonstration Area	Target Sampling Depth Interval (inches bss)	Primary Objective	Sampling Parameter (Matrix)	Volume Required per Sample
S1A1 (river mouth)	0 to 4	P1 Volume P2 Depth interval P3 Consistent samples from a homogenous layer P6 Sample collection time	PSD and volume (sediment)	250 mL
S1A2 (freshwater bay)	0 to 4	P1 Volume P2 Depth interval P5 Decontamination P6 Sample collection time P7 Cost	PCBs and volume (sediment) PCBs (final rinsate)	250 mL 1 L
S2A1 (lake)	0 to 4	P1 Volume P2 Depth interval P3 Consistent samples from a homogenous layer P5 Decontamination P6 Sample collection time P7 Cost	Arsenic, PSD, and volume (sediment) Arsenic (final rinsate)	250 mL 500 mL

Notes:

- bss = Below sediment surface
- L = Liter
- mL = Milliliter
- PCB = Polychlorinated biphenyl
- PSD = Particle size distribution

- Primary objective P2 was generally addressed as described for the Russian Peat Borer. The volume of sediment collected and the approximate sampler penetration depth were noted. However, measurement of core lengths was not appropriate for the Ekman Grab and was not conducted.
- Primary objective P3 was addressed as described for the Russian Peat Borer except that sample collection was limited to the 0- to 4-inch bss depth intervals in S1A1 and S2A1.
- Primary objectives P5, P6, and P7 were addressed in the 0- to 4-inch bss depth intervals in S1A2 and S2A1 as described for the Russian Peat Borer. P6 was also addressed in the 0- to 4-inch bss depth interval in S1A1.

Secondary objectives S1, S2, and S3 were addressed for the Ekman Grab in all three demonstration areas because no additional sampling was required to address them. Secondary objectives S4 and S5 were not area-dependent; they were addressed for the Ekman Grab based on information provided by the sampling technician as well as observations of sampler performance during the demonstration. The approach for addressing each secondary objective was the same as that for the Russian Peat Borer presented in Section 4.2 of the ITVR.

### ***B.3.3 Field Sampling and Measurement Procedures***

Using the Ekman Grab, sediment samples were collected in S1A1 for PSD analysis, in S1A2 for PCB analysis, and in S2A1 for PSD and arsenic analyses. The sampling locations in each of these demonstration areas are presented in Figure B-2. Additional information on these areas and the sampling platforms used is presented in Chapter 3 of the ITVR. Table B-2 lists the target sampling depth interval, planned numbers of investigative samples, and analytical parameters for each demonstration area and provides the rationale for their selection. In general, the rationale for choosing the number of samples to be collected in each area was based on the objectives to be addressed, the analyses to be conducted to address one or more objectives, the time required to collect samples, and the cost of each analysis. When five samples were to be collected in a sampling area, samples were collected in the four corners and center of the area; when ten samples were

to be collected in a sampling area, the additional five samples were collected at locations randomly distributed throughout the area.

Many of the field measurements made to support the primary objectives were simple, standard measurements and do not require additional explanation. These measurements included the volume of IDW generated, number of sampling technicians, number of sampling attempts per location, volume of sediment collected, time required for sample collection activities, sampling area grid size, and water velocity. However, several field measurements were made to address demonstration-specific requirements, and additional explanation of these measurements is warranted to enhance understanding of the sampler performance results presented in Section B.4. Information regarding sample preparation, sampler decontamination, and measurement of the time required to conduct sample collection activities (sampler setup, sample collection, sampler disassembly, and sampler decontamination) is presented in Section 4.3 of the ITVR.

The depth of Ekman Grab deployment was measured after the sampling technician had lowered the sampler to the sediment surface. Once the technician identified the location of the sediment surface using the sampler, a mark was made on the extension handle or polyester line with reference to a fixed point (the boat side or floor). For extension handle applications, another mark was made higher on the extension handle indicating the depth to which the sampler should be pushed in order to collect a sediment sample in the target sampling depth interval. The sampler was pushed to this depth, and a sample was collected. For polyester line applications, the depth of sampler deployment was dictated by gravity penetration. Once the sampling technician had lowered the sampler to the sediment surface using the polyester line, he allowed the sampler to penetrate the sediment by its own weight. The depth of sampler deployment was then measured by making another mark on the polyester line with reference to the fixed point.

Field and laboratory QC checks for the demonstration are discussed in Sections 4.3 and 4.4 of the ITVR, respectively. Section 4.4 of the ITVR also presents the laboratory sample preparation and analysis methods. Table B-3 identifies the planned numbers of sediment and equipment rinsate samples. Acceptance criteria and associated corrective actions for field QC checks are

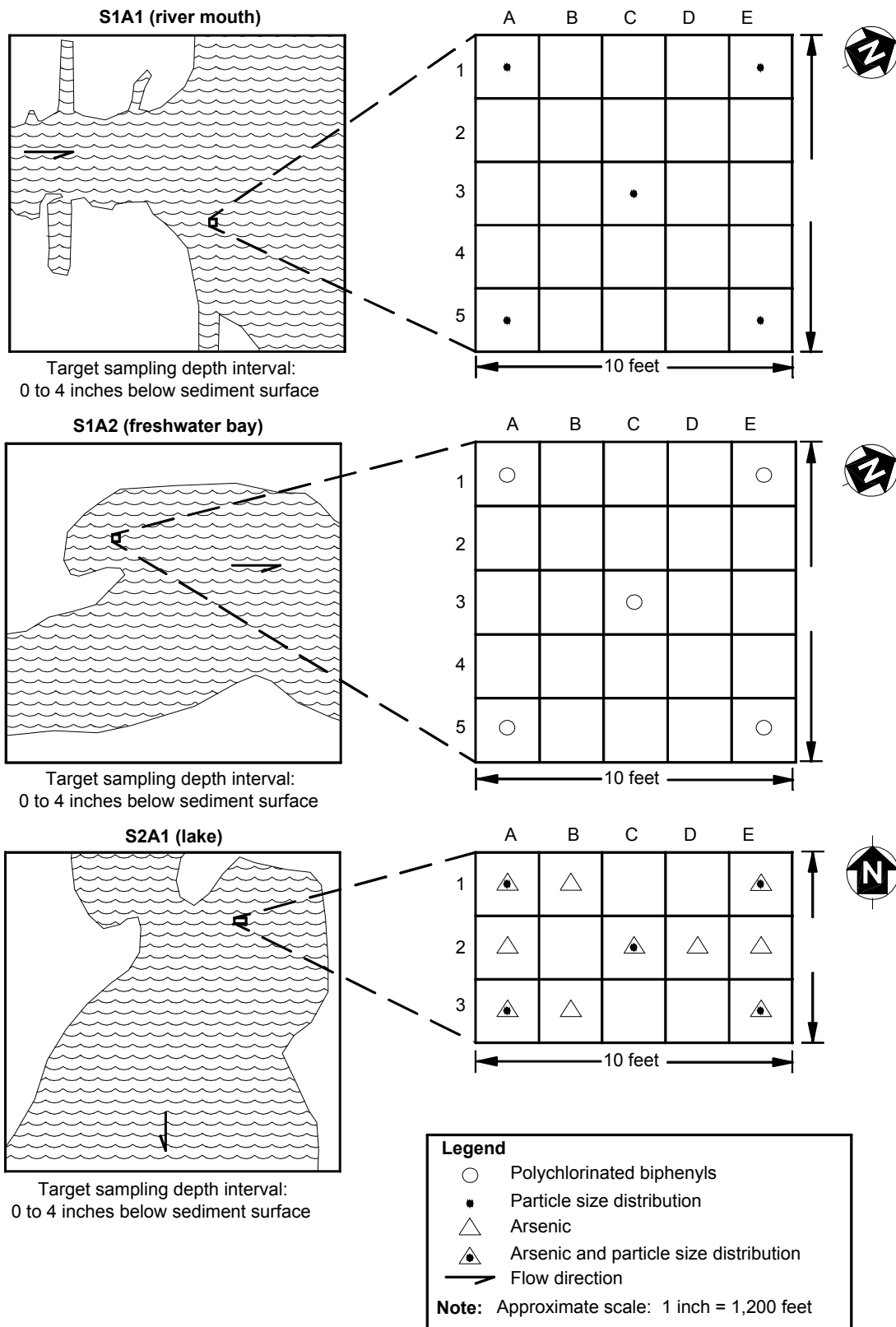

Figure B-2. Sampling locations for Ekman Grab demonstration.

**Table B-2. Rationale for Sampling Approach**

Demonstration Area	Target Sampling Depth Interval (inches bss)	Number of Investigative Samples <sup>a</sup> (Analytical Parameter)	Matrix	Rationale
S1A1 (river mouth)	0 to 4	5 (PSD)	Sediment	Determine whether an Ekman Grab could collect multiple samples from a homogenous layer of sediment (primary objective P3) with consistent characteristics
S1A2 (freshwater bay)	0 to 4	5 (PCBs)	Sediment	Determine whether an Ekman Grab could be adequately decontaminated (primary objective P5)
		1 (PCBs)	Equipment rinsate	Determine whether an Ekman Grab could be adequately decontaminated (primary objective P5)
S2A1 (lake)	0 to 4	10 (Arsenic) 5 (PSD)	Sediment	Determine whether an Ekman Grab could collect multiple samples from a homogenous layer of sediment (primary objective P3) with consistent characteristics
		1 (Arsenic)	Equipment rinsate	Determine whether an Ekman Grab could be adequately decontaminated (primary objective P5)

Notes:

- bss = Below sediment surface
- PCB = Polychlorinated biphenyl
- PSD = Particle size distribution

<sup>a</sup> The number of investigative samples varied depending on the analytical parameters and the objectives addressed in each demonstration area. Ten investigative samples were collected and analyzed for arsenic to address primary objective P3. However, only five investigative samples were collected and analyzed for PSD to address primary objective P3 because the variability associated with PSD is less than that associated with arsenic concentrations.

presented in the demonstration plan (EPA 1999). A summary discussion of whether the field and laboratory QC procedures generated scientifically valid and legally defensible data that met the demonstration objectives is presented in Section B.4.3.

**B.4 Performance of the Ekman Grab**

This section describes the performance of the Ekman Grab based on the primary objectives (Section B.4.1) and secondary objectives (Section B.4.2); this section also discusses the data quality of the demonstration results for the Ekman Grab (Section B.4.3).

**B.4.1 Primary Objectives**

This section discusses the performance results for the Ekman Grab based on the primary objectives specified in Section B.3.1. To address these primary objectives, samples were collected in three different areas: (1) S1A1, a river mouth; (2) S1A2, a small, freshwater bay; and (3) S2A1, a lake. Samples were collected only in the 0- to 4-inch bss depth interval in these areas because the Ekman

Grab is capable of collecting surficial sediment only. The numbers of investigative and QC samples collected in each area, sediment sample volumes required, and sample analytical parameters are presented in Table B-3.

During the demonstration, because the water depth in S1A1 and S2A1 exceeded the length of the extension handle (5 feet), the sampling technician deployed the Ekman Grab by gravity penetration using a polyester line. In S1A2, where the water depth was about 2 feet, the sampler was deployed with the 5-foot-long extension handle. The sampling technician was provided an opportunity to practice sample collection at each demonstration area until he felt confident enough to initiate demonstration sampling.

The demonstration results for the Ekman Grab under primary objectives P1 and P2 were evaluated using the Wilk-Shapiro test to determine whether the results were normally distributed. Because most of the data sets were not normally distributed, the Wilk-Shapiro test was used in an attempt to evaluate whether the results followed a lognormal distribution. The test revealed that the results

**Table B-3. Ekman Grab Sample Matrix**

Demonstration Area	Target Sampling Depth Interval (inches bss)	Analytical Parameter	Sediment Samples				Equipment Rinsate Samples		
			Investigative Samples	MS/MSD Samples <sup>a</sup>	Field Triplicate Samples <sup>b</sup>	Laboratory Analyses	Equipment Rinsate Samples	Field Duplicate Samples <sup>c</sup>	Laboratory Analyses
S1A1 (river mouth)	0 to 4	PSD	5	NA	1	7	NA	NA	0
S1A2 (freshwater bay)	0 to 4	PCBs	5	1	2	11	1	1	2
S2A1 (lake)	0 to 4	Arsenic	10	2	3	20	1	1	2
		PSD	5	NA	1	7	NA	NA	0

**Notes:**

- bss = Below sediment surface
- MS/MSD = Matrix spike/matrix spike duplicate
- NA = Not applicable
- PCB = Polychlorinated biphenyl
- PSD = Particle size distribution

- <sup>a</sup> MS/MSD samples were collected for PCB and arsenic analyses and were designated in the field. MS/MSD samples were not collected for equipment rinsate samples because the additional volume required for the analysis may have diluted any contamination present to concentrations below laboratory detection limits. Sediment MS/MSD samples did not require additional sample volume.
- <sup>b</sup> Field triplicate sediment samples were collected by filling three sample containers with homogenized sediment. A sufficient volume of sediment for field triplicate samples was collected as described in the approach for addressing primary objective P1 in Section 4.2 of the innovative technology verification report. Field triplicate samples were submitted for analysis as blind samples.
- <sup>c</sup> Field duplicate equipment rinsate samples were collected by filling one additional container for PCB or arsenic analysis. Field duplicate samples were submitted for analysis as blind samples.

either were not lognormally distributed or could not be tested for lognormality because the results contained values equal to zero. For these reasons, the Student’s t-test, a parametric test, was not used to perform the hypothesis testing; the Wilcoxon signed rank test, a nonparametric test, was used as an alternative to the Student’s t-test. As described in Section 6.1 of the ITVR, Statistix<sup>®</sup> was used to perform statistical evaluations of the demonstration results (Analytical Software 1996). Appendix C provides details on the statistical methods used for data evaluation.

**B.4.1.1 Ability to Consistently Collect a Specified Volume of Sediment**

Primary objective P1 involved evaluating the Ekman Grab’s ability to consistently collect a specified volume of sediment. This objective was addressed by comparing (1) the actual number of sampling attempts required to collect a specified volume of sediment to the expected

number of attempts (rounded to the nearest higher integer) at each sampling location and (2) the actual volume of sediment collected in each attempt to the calculated sampler volume (design volume). The expected number of attempts was determined by dividing the specified sample volume by the design volume. The results of these comparisons are summarized below.

**Number of Sampling Attempts Required**

Tables B-4 and B-5 present the expected and actual number of sampling attempts for the Ekman Grab in S1A1 and S1A2 and in S2A1, respectively. Initially, the Wilcoxon signed rank test was used to determine whether the difference between the expected and actual number of attempts was statistically significant. However, in two of the three areas, there were too few locations where the expected number of attempts differed from the actual number to perform the test.



**Table B-4. Comparison of Expected and Actual Number of Sampling Attempts for Ekman Grab at Site 1**

Location	Number of Attempts in S1A1 (River Mouth)		Number of Attempts in S1A2 (Freshwater Bay)	
	Expected	Actual	Expected	Actual
1A	1	4	1	1
1E	1	1	1	1
3C	1	1	1	1
5A	1	1	1	1
5E	1	2	1	1
Total	5	9	5	5

**Table B-5. Comparison of Expected and Actual Number of Sampling Attempts for Ekman Grab in S2A1 (Lake)**

Location	Number of Attempts in S2A1	
	Expected	Actual
1A	1	1
1B	1	2
1E	1	2
2A	1	1
2C	1	1
2D	1	1
2E	1	2
3A	1	1
3B	1	1
3E	1	1
Total	10	13

Regarding the number of sampling attempts required to collect the specified volume, the Ekman Grab performed well in all three areas. As shown in Tables B-4 and B-5, the actual number of attempts equaled the expected number of attempts at 15 of 20 locations. In S1A1, Location 1A was the only location where the actual number of attempts (four) exceeded the expected number (one) by more than one attempt. In two of the four attempts at Location 1A, only one scoop was closed after the messenger was released, and the sediment sample was lost through the open scoop.

Much of the sampler’s overall success in terms of number of sampling attempts required can be attributed to the design volume for the Ekman Grab (about 2,900 mL for the 0- to 4-inch bss depth interval, including the volume of the scoops) being much greater than the specified sediment sample volumes, which ranged from 250 to 1,000 mL. Consequently, a sampling attempt with low

recovery compared to the design volume could still collect the specified volume of sediment.

**Volume of Sediment Collected**

The volume of sediment collected by the Ekman Grab in each sampling attempt was divided by the corresponding design volume, and the resulting ratio was multiplied by 100 to estimate the PSR. The RSD of the PSRs was calculated to evaluate the ability of the Ekman Grab to consistently collect a specified volume of sediment; if the sampler were to consistently recover an identical volume of sediment in every attempt, the RSD would equal zero. Both PSR and RSD results should be considered to properly evaluate the sampler’s performance because a low RSD, which indicates that the sampler’s performance was consistent, may be based on consistently low PSRs. Table B-6 presents the PSR summary statistics (range, mean, and RSD) for all three areas. Figure B-3 presents PSRs for the Ekman Grab in S1A1, S1A2, and S2A1.

The Ekman Grab performed well in S1A2 but had difficulty in S1A1 and S2A1. As shown in Table B-6, for S1A2, PSRs ranged from 100 to 145 with a mean PSR of 127. The RSD of the PSRs for S1A2 (13 percent) compares favorably to the 30 percent RSD guideline discussed in Section 6.1.1 of the ITVR. On the other hand, as shown in Figure B-3, 5 of 9 attempts in S1A1 and 3 of 13 attempts in S2A1 had PSRs in the 0 to 20 range. These low recoveries were due to the failure of one or both scoops to close after the messenger was released or to incomplete sampler penetration of the specified depth interval. Unlike S1A2, where the sampler was deployed with an extension handle, the sampler was deployed by gravity penetration using a polyester line in S1A1 and S2A1. As a result, the sampling technician had relatively poor control of the depth of sampler penetration. As



**Table B-6. Percent Sample Recovery Summary Statistics for Ekman Grab**

Demonstration Area	Actual Number of Attempts	PSR Range <sup>a</sup>	Mean PSR	RSD (%)
S1A1 (river mouth)	9	0 to 40	16	103
S1A2 (freshwater bay)	5	100 to 145	127	13
S2A1 (lake)	13	0 to 71	38	65

Notes:

PSR = Percent sample recovery  
 RSD = Relative standard deviation

<sup>a</sup> PSRs exceeding 100 resulted from pushing the sampler beyond the specified depth interval because of difficulty in accurately assessing the location of the sediment, the volumetric measurement error associated with the presence of void spaces when the sediment was transferred to a graduated container, or both.

shown in Table B-6, RSDs of 103 and 65 percent that exceeded the 30 percent RSD guideline were observed for S1A1 and S2A1, respectively, indicating that the Ekman Grab did not consistently collect its design volume.

In summary, the Ekman Grab performed well with regard to the number of attempts required, but did not perform well with regard to consistently collecting its design volume. The actual number of attempts equaled the expected number of attempts at 15 of 20 locations. However, for S1A1 and S2A1, low mean PSRs (16 and 38, respectively) and high RSDs (103 and 65 percent, respectively) were observed, indicating low and inconsistent recoveries. For S1A2, a much lower RSD (13 percent) was observed. In addition, all the PSRs for sampling attempts in S1A2 were 100 or greater.

**B.4.1.2 Ability to Consistently Collect Sediment in a Specified Depth Interval**

Primary objective P2 involved evaluating the Ekman Grab’s ability to consistently collect sediment in a specified depth interval by comparing actual and target core lengths for each attempt. The Ekman Grab does not collect a core, but to facilitate its comparison to the other samplers, the actual depth interval sampled in a given attempt was calculated based on the Ekman Grab’s design volume and the volume of sediment collected.

The Ekman Grab’s box chamber is 6 inches tall and can hold about 580 mL of sediment per inch. The scoop chamber has a triangular cross section; is approximately 1.5 inches tall in the middle; and can hold about 105 mL in the bottom one-third, about 210 mL in the middle

one-third, and about 315 mL in the top one-third, which amounts to a total volume of about 630 mL. Therefore, if the Ekman Grab collected 2,100 mL of sediment in a given attempt, the sampling depth interval is 0 to 4 inches bss because the 1.5-inch-tall scoop chamber holds 630 mL, and the remaining 1,470 mL would fill approximately 2.5 inches of the box chamber at 580 mL per inch. However, the height of the scoop chamber was not accounted for during demonstration sampling, and the sampling technician tried to push the box chamber to a depth of 4 inches bss in each attempt. Consequently, the target sediment thickness in each area was actually 5.5 inches instead of 4 inches, which corresponds to a sample volume of approximately 2,900 mL.

Table B-7 presents the number of attempts in which the actual sediment thickness equaled the target sediment thickness, target sediment thicknesses, and mean actual sediment thicknesses. Initially, the Wilcoxon signed rank test was to be used to determine whether differences between the actual and target sediment thicknesses were statistically significant. However, the Wilcoxon signed rank test revealed that the test results for many of the primary objective P2 data sets were inconsistent with the conclusions reached in comparing the actual and target sediment thicknesses for the reasons described in Section 6.1 of the ITVR. Therefore, P2 was addressed by evaluating (1) the number of attempts in which the actual sediment thickness equaled the target sediment thickness and (2) the difference between the target sediment thickness and the mean actual sediment thickness.

The Ekman Grab did not perform well in any of the three areas. As shown in Table B-7, sediment thicknesses

Figure B-3. Percent sample recoveries for Ekman Grab in S1A1 (river mouth), S1A2 (freshwater bay), and S2A1 (lake).

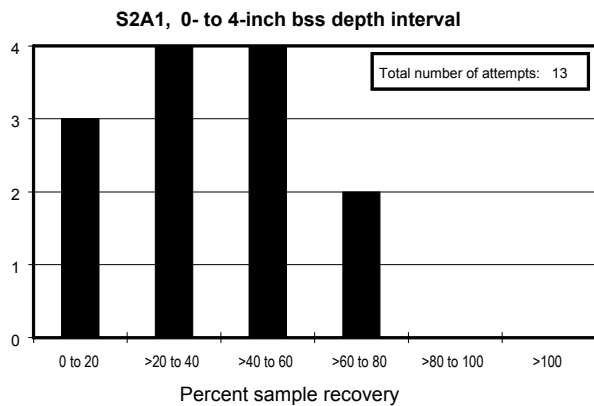
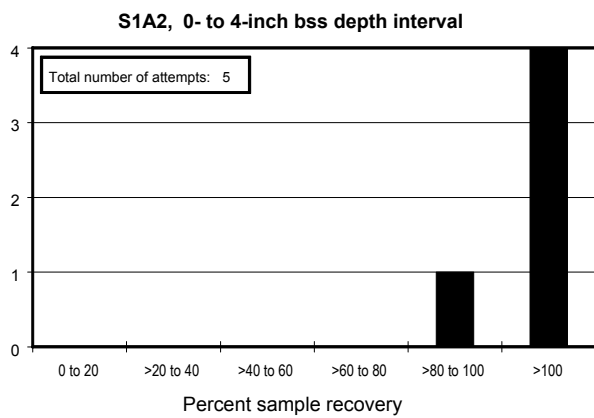
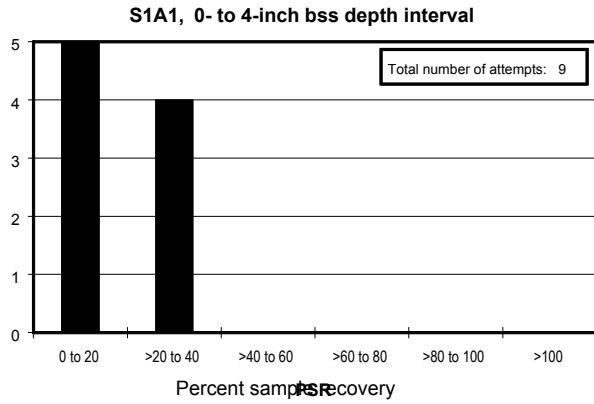

Notes:

bss = Below sediment surface

Percent sample recoveries exceeding 100 resulted from pushing the sampler beyond the specified depth interval because of difficulty in accurately assessing the location of the sediment surface, the volumetric measurement error associated with the presence of void spaces when the sediment was transferred to a graduated container, or both.

collected by the Ekman Grab equaled the target sediment thicknesses in only 1 of 27 attempts. Attempts in S1A1 and S2A1 generally had low recoveries (0 to 40 percent in S1A1 and 0 to 71 percent in S2A1), which resulted in low mean actual sediment thicknesses of 1.0 and 2.5 inches, respectively. In S1A2, the mean actual sediment thickness of 6.5 inches exceeded the target sediment thickness of 5.5 inches. Although the Ekman Grab sampled the entire target sediment thickness in all 5 attempts, in 4 of the 5 attempts in S1A2, the actual sediment thickness exceeded the target sediment thickness by 1 inch on average. Because of the nature of the sampler, the portion of the sediment sample corresponding to the 5.5- to 6.5-inch bss depth interval could not be separated from that corresponding to the target depth interval. Based on demonstration results, the Ekman Grab did not demonstrate an ability to consistently collect sediment in the specified depth interval.

#### **B.4.1.3 Ability to Collect Multiple Samples with Consistent Physical or Chemical Characteristics, or Both, from a Homogenous Layer of Sediment**

Primary objective P3 involved evaluating the Ekman Grab's ability to collect multiple samples with consistent physical or chemical characteristics, or both, from a homogenous layer of sediment. This objective was addressed by calculating the RSD values for the S1A1 and S2A1 sample analytical results. Based on the predemonstration investigation results, the 0- to 4-inch bss depth intervals in these areas were determined to be homogenous in terms of their physical characteristics, and the S2A1 depth interval was determined to be homogenous in terms of its chemical characteristics.

Figure B-4 presents the Ekman Grab sample analytical results for S1A1 and S2A1. Although no outliers were found in the arsenic and PSD results for the samples collected by the Ekman Grab, the sampler was evaluated only on its ability to collect multiple samples with consistent physical characteristics; this approach was used to be consistent with the evaluations of the innovative and reference samplers discussed in Sections 6.1.3 and 7.1.3, respectively. Also, the Ekman Grab sample arsenic concentrations for S2A1 varied over a wide range (53 to 240 mg/kg), indicating that the area may not be chemically homogenous despite the lack of statistical outliers. The

**Table B-7. Comparison of Target and Actual Sediment Thickness Data for Ekman Grab**

Demonstration Area	Number of Attempts in Which Actual Sediment Thickness Equaled Target Sediment Thickness/Total Attempts	Target Sediment Thickness (inches)	Mean Actual Sediment Thickness (inches)
S1A1 (river mouth)	0/9	5.5	1.0
S1A2 (freshwater bay)	1/5	5.5	6.5
S2A1 (lake)	0/13	5.5	2.5

RSDs were calculated based on the PSD analytical results for all locations sampled in S1A1 and S2A1.

Table B-8 presents PSD summary statistics (range, mean, and RSD) calculated for the Ekman Grab samples and field triplicates relevant to primary objective P3. As stated in Section 6.1.3 of the ITVR, RSDs calculated for the PSD results were compared to the laboratory acceptance criterion of 15 percent for field triplicates. When the RSD for all samples was greater than 15 percent, it was compared to the measured RSD for the field triplicates, which were prepared by first homogenizing and then subsampling the sediment collected in a given location and area. An RSD for all samples that is less than the RSD for field triplicates may be more attributable to the laboratory’s analytical procedure or the sample homogenization procedure implemented in the field, or both, for the sediment sampled than to the sampler’s ability to collect physically consistent samples. However, PSD parameters with means less than 10 percent were not evaluated in this manner because at low levels, the analytical method is not as precise; as a result, it will generate high RSD values and may not reveal whether multiple samples with consistent physical characteristics have been collected.

As shown in Table B-8, the RSDs for silt results for both S1A1 and S2A1 were below the 15 percent laboratory acceptance criterion. The RSD for the sand result for S1A1 was also below the laboratory acceptance criterion, but the sand result RSD for S2A1 (17 percent) was 2 percentage points above the laboratory acceptance criterion and above the measured RSD for field triplicates (8 percent). Therefore, some of the variation in the sand results may be attributable to the Ekman Grab’s ability to collect samples with consistent physical characteristics. However, the variation in the sand results for S2A1 was not considered to be significant because it was only 2 percentage points greater than the laboratory acceptance

criterion. The mean clay results for samples collected in both S1A1 and S2A1 were less than 10 percent and were not evaluated using the criterion. However, the clay results fell in a tight range (0 to 2 and 0 to 5 percent in S1A1 and S2A1, respectively).

In summary, the Ekman Grab met primary objective P3 criteria except for a 2 percentage point exceedance in the RSD for sand results for S2A1. Therefore, it was concluded that the Ekman Grab was able to collect multiple samples with consistent physical characteristics.

**B.4.1.4 Ability to be Adequately Decontaminated**

Primary objective P5 involved evaluating the Ekman Grab’s ability to be adequately decontaminated. This objective was addressed by collecting equipment rinsate samples after sampler decontamination activities in S1A2 and S2A1. These areas were chosen because they contained high concentrations of PCBs and arsenic, respectively. If the Ekman Grab were adequately decontaminated, the analytical results for the equipment rinsate samples would be below the laboratory’s reporting limits. To ensure that the water used to decontaminate the sampler was not contaminated, decontamination water blanks were also analyzed. Contaminant concentrations in both the equipment rinsate samples and decontamination water blanks were below the laboratory reporting limits for PCBs (1 part per billion) and arsenic (10 parts per billion). Thus, the Ekman Grab demonstrated the ability to be adequately decontaminated.

**B.4.1.5 Time Requirements for Sample Collection Activities**

Primary objective P6 involved evaluating the Ekman Grab’s time requirements for sample collection activities. These requirements were evaluated in S1A1, S1A2, and S2A1. One technician conducted sampler setup, sample

**S1A1**

<b>Location 1A</b> Sand: 83% Silt: 17% Clay: 0%				<b>Location 1E</b> Sand: 84% Silt: 14% Clay: 2%
		<b>Location 3C</b> Sand: 84% Silt: 15% Clay: 0%		
<b>Location 5A</b> Sand: 85% Silt: 15% Clay: 0%				<b>Location 5E</b> Sand: 86% Silt: 13% Clay: 1%

**S2A1**

<b>Location 1A</b> Arsenic: 110 mg/kg Sand: 39% Silt: 55% Clay: 5%	<b>Location 1B</b> Arsenic: 87 mg/kg			<b>Location 1E</b> Arsenic: 200 mg/kg Sand: 33% Silt: 57% Clay: 2%
<b>Location 2A</b> Arsenic: 240 mg/kg		<b>Location 2C</b> Arsenic: 110 mg/kg Sand: 42% Silt: 53% Clay: 4%	<b>Location 2D</b> Arsenic: 160 mg/kg	<b>Location 2E</b> Arsenic: 130 mg/kg
<b>Location 3A</b> Arsenic: 53 mg/kg Sand: 52% Silt: 46% Clay: 0%	<b>Location 3B</b> Arsenic: 110 mg/kg			<b>Location 3E</b> Arsenic: 89 mg/kg Sand: 48% Silt: 51% Clay: 0%

Notes:

mg/kg = Milligram per kilogram

The particle size distribution results for a given sample may not total 100 percent because of rounding or because some sediment did not pass through a U.S. Standard No. 4 sieve and was classified as gravel rather than sand, silt, or clay.

Figure B-4. Ekman Grab sample analytical results for S1A1 (river mouth) and S2A1 (lake).

**Table B-8. Particle Size Distribution Summary Statistics for Ekman Grab**

Demonstration Area	Parameter	Number of Samples	Range (%)	Mean (%)	RSD (%) (All Samples)	RSD (%) (Field Triplicates)
S1A1 (river mouth)	Sand	5	83 to 86	84	1	1
	Silt	5	13 to 17	15	10	8
	Clay	5	0 to 2	1	128	173
S2A1 (lake)	Sand	5	33 to 52	43	17	8
	Silt	5	46 to 57	53	8	4
	Clay	5	0 to 5	2	104	35

Note:

RSD = Relative standard deviation

collection, sampler disassembly, and sampler decontamination in each of the three demonstration areas. The amounts of time required to complete these activities are shown in Table B-9. The time measured for sample collection activities did not include the time taken for mobilization, demobilization, and maneuvering the sampling platforms to sampling locations because these activities were not sampler-specific; they were either site- or weather-related.

Sampler setup times for the Ekman Grab ranged from 1 minute in S1A1 and S2A1 to 4 minutes in S1A2. The Ekman Grab was operated using a polyester line in S1A1 and S2A1 because the water depth was greater than the length of the extension handle available during the demonstration. In S2A1, the sampler arrived with the polyester line used to lower the sampler already attached; therefore, the setup time for S2A1 was estimated to be equal to the setup time for S1A1. An extension handle was used instead of the polyester line in S1A2, which required additional sampler setup time.

Sample collection times for the Ekman Grab ranged from 8 to 40 minutes during the demonstration. Sample collection required 0.5 to 2 minutes per attempt in S1A1 and S1A2 but 1.5 to 3.5 minutes per attempt in S2A1. Additional time was required in S2A1 because it was the first area sampled and because the water depth was 18 feet.

Sampler disassembly times for the Ekman Grab ranged from 1 to 3 minutes during the demonstration. Sampler disassembly required 3 minutes in S1A2. In S1A1, the disassembly time was estimated to be equal to the sampler setup time. Because a disassembly time of less than

1 minute was recorded in S2A1, the time for sampler disassembly in this area was conservatively rounded up to 1 minute.

Decontamination of the Ekman Grab required 22 minutes in S1A2 and 13 minutes in S2A1; sampler decontamination time was not evaluated in S1A1. Decontamination of the extension handle used in S1A2 accounts for the difference in decontamination times between this area and S2A1.

A technician familiar with the Ekman Grab would be expected to require 1 to 4 minutes for sampler setup, 0.5 to 2 minutes per attempt for sample collection, about 3 minutes for sampler disassembly, and 15 to 20 minutes for sampler decontamination. However, these activities might take longer, depending on the number of extension handles used at a given location. Furthermore, when sediment sampling activities are planned, the time required for mobilization, demobilization, and setting up and positioning the sampling platform would have to be considered in addition to the times presented above.

**B.4.1.6 Costs Associated with Sample Collection Activities**

Primary objective P7 involved estimating costs associated with Ekman Grab sample collection activities in S1A2 and S2A1. Because characteristics of these two areas are different, the sampling activities in these areas were expected to provide a range of costs involved in conducting sediment sampling using the Ekman Grab. For example, during the demonstration in S1A2, the average PCB concentration was about 310 parts per billion, and the water depth was about 2 feet. On the other hand, in S2A1,



**Table B-9. Time Required to Complete Sampling Activities for Ekman Grab**

Activity	Time Required (minutes)		
	S1A1 (River Mouth)	S1A2 (Freshwater Bay)	S2A1 (Lake)
Sampler setup	1	4	1
Sample collection	10	8	40
Sampler disassembly	1	3	1
Sampler decontamination	Not evaluated	22	13
<b>Total</b>	<b>12</b>	<b>37</b>	<b>55</b>

the average arsenic concentration was 120 mg/kg, and the water depth was about 18 feet.

The issues and assumptions discussed in Section 8.1 of the ITVR apply to this section as well except that unused sediment in S2A1 was assumed to be a hazardous waste. During the demonstration, the average arsenic concentration in the samples collected using the Ekman Grab was 120 mg/kg. Arsenic-contaminated wastes with TCLP extract concentrations greater than 5 mg/L must be disposed of as hazardous waste (40 CFR 261). Based on the average arsenic concentration and the dilution factor (20) associated with the TCLP, the TCLP extract concentration for the sediment waste generated during the demonstration was estimated to be about 6 mg/L. Therefore, unused sediment in S2A1 was assumed to be a hazardous waste.

This section presents information on sampler, labor, IDW disposal, and support equipment costs for the Ekman Grab as well as a summary of these costs. Table B-10 presents these costs.

**Sampler Cost**

In S1A2, the Ekman Grab was used with one 5-foot extension handle. The Ekman Grab and extension handle costs were \$304 and \$131, respectively. The total sampler cost for S1A2 was estimated to be \$435.

In S2A1, the Ekman Grab was used with one messenger and polyester line. The Ekman Grab and messenger costs were \$304 and \$52, respectively. The polyester line cost less than \$10 and therefore was not included in the estimate. The total sampler cost for S2A1 was estimated to be \$356.

**Labor Cost**

In S1A2, the time for sampler setup, sample collection, sampler disassembly, and sampler decontamination totaled 37 minutes or about 1 hour for one technician. In this area, five investigative samples for PCB analysis were collected using the Ekman Grab. Table B-3 presents additional information on the total number of samples collected. The labor cost for sampling in S1A2 was estimated to be \$34.

In S2A1, the time for sampler setup, sample collection, sampler disassembly, and sampler decontamination totaled 55 minutes or about 1 hour for one technician. In this area, ten investigative samples for arsenic analysis and five investigative samples for PSD analysis were collected using the Ekman Grab. Table B-3 presents additional information on the total number of samples collected. The labor cost for sampling in S2A1 was estimated to be \$34.

**IDW Disposal Cost**

Sampling in S1A2 generated IDW consisting of 15 L of unused sediment. The cost for disposal of one 55-gallon drum of nonhazardous waste is \$182.

Sampling in S2A1 generated IDW consisting of 7 L of unused sediment. The cost for disposal of one 55-gallon drum of hazardous waste is \$196.

**Support Equipment Cost**

Support equipment used during Ekman Grab sampling in S1A2 and S2A1 included a crescent wrench and a Phillips-head screwdriver. The costs of these items were not included in the estimate because a field sampling team would already have such tools as part of its field sampling gear.

**Table B-10. Ekman Grab Cost Summary**

Item	Quantity	Unit Cost (\$)	Total Cost (\$)
<b>S1A2 (Freshwater Bay) Costs</b>			
Sampler			
Ekman Grab	1 unit	304	304
Extension handle	1 unit	131	131
Labor	1 hour	34	34
IDW disposal	1 55-gallon drum	182	182
Support equipment	Not applicable	Not applicable	0
<b>Total<sup>a</sup></b>			<b>\$650</b>
<b>S2A1 (Lake) Costs</b>			
Sampler			
Ekman Grab	1 unit	304	304
Messenger	1 unit	52	52
Labor	1 hour	34	34
IDW disposal	1 55-gallon drum	196	196
Support equipment	Not applicable	Not applicable	0
<b>Total<sup>a</sup></b>			<b>\$590</b>

Notes:

IDW = Investigation-derived waste

<sup>a</sup> The total dollar amount is rounded to the nearest \$10.

### Summary of Ekman Grab Costs

In summary, for the Ekman Grab, the costs to collect the numbers of samples listed in Table B-3 were estimated to be \$650 and \$590 for S1A2 and S2A1, respectively. Most of the costs were associated with the purchase of samplers (about 67 percent for S1A2 and 60 percent for S2A1) and IDW disposal (about 28 percent for S1A2 and 33 percent for S2A1).

#### B.4.2 Secondary Objectives

This section describes the performance results for the Ekman Grab based on the secondary objectives specified in Section B.3.1. The secondary objectives were addressed based on observations of Ekman Grab performance during the demonstration.

##### B.4.2.1 Skill and Training Requirements for Proper Sampler Operation

The Ekman Grab is easy to operate, requiring minimal skills and training. Sampler assembly and sample

collection procedures can be learned in the field with a few practice attempts. In addition, a written SOP accompanies the sampler when it is procured. The sampler can be operated by one person in shallow (wading) and deep water depths because of its lightness (10 lb, not including the weight of the extension handle). Sampler operation is simple because the sampler does not require complete disassembly and reassembly after each sampling attempt. Only the scoops or lids have to be opened in order to retrieve the sediment sample. The sampler requires no support equipment unless a sampling platform is needed.

During the demonstration, minimal strength and stamina were required to deploy the sampler into and retrieve it from the 0- to 4-inch bss depth interval in S1A1, S1A2, and S2A1. Previous sediment sampling experience is beneficial in selecting the most appropriate optional accessories (such as the extension handle length or weight attachments) for a given Ekman Grab application. Previous sediment sampling experience is also beneficial for accurately assessing the location of the sediment

surface using the sampler, as is the case with other samplers.

#### **B.4.2.2 Ability to Collect Samples Under a Variety of Site Conditions**

The Ekman Grab demonstrated the ability to collect sediment samples under all conditions encountered during the demonstration, which included a variety of sampling platforms, water depths, sediment depths, and sediment compositions. During the demonstration, the range of platforms used included an 18-foot-long, 4-foot-wide Jon boat in S1A2; a sturdier, 30-foot-long, 8-foot-wide pontoon boat in S2A1; and the EPA GLNPO *Mudpuppy* in S1A1. Because the sampler does not require electricity or a tripod-mounted winch for deployment, sampler operation was feasible from any location on the sampling platforms used.

Because of the lightness of the sampler and extension handle (when needed), water depth had no significant impact on the sampling technician's ability to deploy and retrieve the sampler. In S1A2, the sampler was deployed and retrieved using a 5-foot-long extension handle because the water depth was about 2 feet. In S1A1 and S2A1, where water depths were about 6 and 18 feet, respectively, the sampler was deployed and retrieved using the polyester line and messenger. As with other samplers, the Ekman Grab's ability to accurately assess the location of the sediment surface decreases with increasing water depth and turbidity. Because of the significant water depth and turbidity in S1A1 and S2A1 and the significant turbidity in S1A2, the sampling technician could not see the sediment surface from the sampling platforms. An underwater video camera may have enabled the sampling technician to accurately assess the location of the sediment surface in these areas (Blomqvist 1991).

Water velocity had an impact on the sampling technician's ability to deploy the sampler when gravity penetration was used. As mentioned above, the sampler was deployed in S1A1 and S2A1 using the polyester line and messenger. During a few sampling attempts in each area, the current carried the sampler at least 1 foot beyond the desired sampling location near the sediment surface. The average water velocity in S1A1 and S2A1 was  $\leq 0.07$  ft/s and  $< 0.05$  ft/s, respectively. In S1A2, where the average water velocity was less than 0.05 ft/s, the sampler was deployed with a 5-foot-long extension handle because the water

depth was only 2 feet. Because use of the extension handle provided more control during positioning of the sampler, water velocity had no significant impact on the sampling technician's ability to properly deploy the sampler.

The sampler was able to collect surficial sediment samples in all three demonstration areas. However, the sampler exhibited a few limitations related to sediment composition. As discussed in Section B.4.1.2 for primary objective P2, the Ekman Grab performed poorly in terms of its ability to consistently collect sediment samples in a specified depth interval. In S1A1 and S2A1, low sediment recoveries were attributed to the failure of one or both of the scoops to close after the messenger was sent. In addition, in these areas, the sampling technician was unable to push the sampler into the sediment because the sampler was attached only to the polyester line. Therefore, the sampler may not have fully penetrated the target depth interval because the weight of the sampler may not have been adequate to overcome the degree of sediment compaction in these areas. In S1A2, the mean actual sediment sample thickness exceeded the target sediment sample thickness. The excessive sample thickness can be attributed to the sampling technician's pushing the sampler beyond the specified depth interval because of his difficulty in accurately assessing the location of the sediment surface using the sampler.

#### **B.4.2.3 Ability to Collect an Undisturbed Sample**

During the demonstration, as was expected given the nature of the sampler, the Ekman Grab did not consistently collect sediment samples in which the sediment stratification was preserved. Specifically, in S1A1 and S2A1, sediment stratification was not preserved. When the samples collected in these areas were discharged into stainless-steel bowls, the samples were unable to retain their form because of their high water content; as a result, sediment from different layers was allowed to mix. However, in S1A2, where the water content in the 0- to 4-inch bss depth interval was relatively low and the sediment contained a relatively high clay content, the samples were able to retain their form after discharge, and the sediment stratification was preserved.

The disturbance associated with bow wave formation near the water-sediment interface was not likely to be significant in S1A2 because the speed of sampler

deployment was controlled by the use of the extension handle. However, in S1A1 and S2A1, the sampler was deployed using the polyester line; the sampler had to be dropped in order to allow gravity penetration into the target depth interval. As a result, the opportunity for bow wave formation was greater in these areas. However, because of the water depth and turbidity in both areas, the sampling technician was unable to observe whether bow wave formation occurred.

#### **B.4.2.4 Durability Based on Materials of Construction and Engineering Design**

As described in Section B.1.1, the Ekman Grab components are made of either stainless steel or galvanized steel. Based on observations made during the demonstration, the Ekman Grab is a sturdy sampler; none of the sampler components was damaged or required repair or replacement during the demonstration.

#### **B.4.2.5 Availability of Sampler and Spare Parts**

As mentioned above, no primary component of the Ekman Grab was damaged or required replacement during the demonstration. Had a primary sampler component (excluding the polyester line) required replacement, it would not have been available in a local retail store. Replacement components may be obtained from the developer by overnight courier in 2 days or less, depending on the location of the sampling site. The polyester line, which may need occasional replacement, should be available locally.

### ***B.4.3 Data Quality***

The overall QA objective for the demonstration was to produce well-documented data of known quality. The TSAs conducted to evaluate data quality did not reveal any problems that would make the demonstration data unusable. The scope of these TSAs is described in Sections 4.3 and 4.4 of this ITVR.

This section briefly discusses the data quality of demonstration results for the Ekman Grab; more detailed information is provided in the DER (Tetra Tech 1999). Specifically, the data quality associated with the field measurement activities is discussed first, followed by the data quality associated with the laboratory analysis activities.

#### **B.4.3.1 Field Measurement Activities**

Field measurement activities conducted during the demonstration included measurement of the time associated with sample collection activities, water velocity, water depth, volume of IDW, volume of sediment collected in a given sampling attempt, and depth of sampler deployment. Of these measurement parameters, specific acceptance criteria were set for the precision associated with the time and water velocity measurements only (EPA 1999). All time and water velocity measurements made during the demonstration met their respective criteria (see Table 6-7). Of the remaining parameters, some difficulties were encountered in measuring the volume of sediment collected in a given sampling attempt and the depth of sampler deployment, which are discussed below.

To measure the volume of sediment collected in a given sampling attempt, the sediment sample was transferred into a 2-L container graduated in increments of 20 mL. The container was tapped on a hard surface to minimize the presence of void spaces in the sample, the sample surface was made even using a spoon, and the volume of the sample was measured. However, because the void spaces could not be completely eliminated, the volumetric measurements are believed to have a positive bias that resulted in overestimation of PSRs. Because the total volume of the void spaces could not be measured, its impact on the PSR results could not be quantified.

The depth of sampler deployment was measured with reference to the sediment surface. To identify the location of the sediment surface, the sampling technician lowered the sampler into the water and used the bottom end of the sampler to feel the sediment surface. Subsequently, the technician used an extension rod to drive the sampler into the sediment to a depth that he estimated to be appropriate to collect a sediment sample or used a polyester line to allow the sampler to penetrate the sediment by gravity. Regardless of the method used to deploy the sampler, the technician could not control the depth of sampler deployment precisely; when the extension rod was used, the actual depth of sampler deployment exceeded the target depth of deployment by up to 2 inches, and when the polyester line was used, the sampler did not fully penetrate the target depth interval. Because of the nature of the Ekman Grab, when the actual depth of penetration was more than the target depth of penetration (as indicated

by the volume of sediment sampled), the portion of the sediment sample associated with the excessive depth of penetration could not be removed from the sampler before the sediment volume was measured; consequently, the PSR results had a positive bias that could not be quantified.

#### B.4.3.2 Laboratory Analysis Activities

The laboratory analyses conducted for the demonstration included the following: (1) PCB, arsenic, and PSD analyses of sediment samples and (2) PCB and arsenic analyses of equipment rinsate samples. To evaluate the data quality of the laboratory analysis results, field-generated QC samples, PE samples, and laboratory QC check samples were analyzed. The field-generated QC samples included the field replicates and temperature blanks described in Section 4.3 of this ITVR. The PE samples and laboratory QC check samples are described in Section 4.4. The acceptance criteria for the QC samples are presented in Table 6-7.

All temperature blanks and field replicates subjected to PCB and arsenic analyses met the acceptance criteria, indicating that the sample homogenization procedure (field replicates) and sample preservation procedure (temperature blanks) implemented in the field met the demonstration requirements. However, as stated in Section B.4.1.3, in a few cases the results of field triplicate sample analyses for PSD did not meet the acceptance criterion. Despite the failures to meet the acceptance criterion, the PSD results are considered to be valid for the reasons detailed in Section B.4.1.3.

The PE sample results for both the PCB and arsenic analyses met the acceptance criteria, indicating that the analytical laboratory accurately measured both PCBs and arsenic.

The analytical results for all laboratory QC check samples except the following met the acceptance criteria: (1) MS/MSD samples for analysis for PCBs in the sediment matrix and (2) equipment rinsate samples for PCB analysis. These issues and their likely impact on data quality are discussed below.

For the sediment matrix, in all MS/MSD samples analyzed for PCBs, Aroclor 1016 was recovered at levels higher than the upper limit of the acceptance criterion, indicating a positive bias in the PCB results for sediment samples. However, the analytical laboratory had no problem meeting the acceptance criteria for control samples such as BS/BSDs. For this reason, the failure to meet the acceptance criterion for MS/MSD sample analysis was attributed to matrix interference. The MS/MSD spiking compounds (Aroclors 1016 and 1260) were selected based on the Aroclors detected during the predemonstration investigation and as recommended in SW-846 Method 8082.

Also for the sediment matrix, in one out of three MS/MSD pairs analyzed for PCBs, Aroclor 1260 was recovered at a level less than the lower limit of the acceptance criterion in the MS sample, but the recovery in the associated MSD sample was acceptable. Because the investigative samples contained only Aroclor 1242, of the two spiking compounds used to prepare the MS/MSD samples, only the Aroclor 1016 recoveries were considered to be relevant based on the PCB congener distribution; the Aroclor 1260 recoveries were not considered to be relevant. Therefore, the low recovery associated with Aroclor 1260 had no impact on data quality.

In all equipment rinsate samples analyzed for PCBs, decachlorobiphenyl (the surrogate) was recovered at levels lower than the lower limit of the acceptance criterion, indicating a negative bias in the PCB results for equipment rinsate samples. However, the analytical laboratory had no problem meeting the acceptance criteria for control samples such as PE samples and deionized water blanks. For this reason, the failure to meet the surrogate recovery acceptance criterion for the equipment rinsate sample analysis was attributed to matrix interference.

## B.5 References

- Analytical Software. 1996. Statistix<sup>®</sup> for Windows. Version 2.0. Tallahassee, Florida.
- Blomqvist, S. 1991. "Quantitative Sampling of Soft-Bottom Sediments: Problems and Solutions." *Marine Ecology Progress Series*. Volume 72. Pages 295 through 304.



---

EPA. 1999. "Sediment Sampling Technologies Demonstration Plan." ORD. Washington, DC. April.

Tetra Tech. 1999. "Sediment Sampling Technologies Data Evaluation Report." Prepared for ORD, EPA. October.



## Appendix C Statistical Methods

This appendix summarizes two statistical methods used in evaluating the Russian Peat Borer demonstration results: the Wilk-Shapiro test for evaluating whether data are normally or lognormally distributed (Section C.1) and the Wilcoxon signed rank test for evaluating whether two data sets are statistically different (Section C.2). Section C.3 lists references used to prepare this appendix. Examples of the use of the two tests are included in each test description. Both tests were performed using Statistix<sup>®</sup> developed by Analytical Software of Tallahassee, Florida (Analytical Software 1996).

### C.1 Wilk-Shapiro Test

The Wilk-Shapiro test is an effective method for testing whether a data set has been drawn from an underlying normal distribution. Furthermore, by conducting the test on the logarithms of the data, it is an equally effective way of evaluating the hypothesis of a lognormal distribution. This test was used to determine whether the demonstration results followed either the normal or lognormal distribution in order to use a parametric test, such as the Student's t-test, for evaluating the results for primary objectives P1, P2, and P4. The Wilk-Shapiro test results indicated that the data sets for P1, P2, and P4 were generally not normally distributed or could not be tested for lognormality because the results contained values that were equal to zero. Therefore, the Wilcoxon signed rank test, a nonparametric test for paired samples that makes no assumptions regarding the distribution, was used as an alternative to the Student's t-test.

For a given data set, the Statistix<sup>®</sup> software package first counts the number of values in the data set and then

generates the same number of expected values as if the data were perfectly, normally distributed. The expected values are generated using a standard normal distribution function (a standard normal distribution has a mean of 0 and a variance of 1). Both the actual and expected values are ranked in numerical order and plotted; the actual values (ordered data) are plotted on the y-axis, and the expected values (rankits) are plotted on the x-axis. The package performs a linear regression analysis and calculates the square of the correlation coefficient, also known as the approximate Wilk-Shapiro normality statistic (W). The W values can range from 0 to 1; 0 indicates no correlation between actual and expected values, and 1 indicates perfect correlation between actual and expected values.

The W values calculated for each data set were compared to critical W values corresponding to various significance levels ( $\alpha$ ) and sample sizes (Gilbert 1987). If the W value for a given data set was greater than the critical value listed for the corresponding sample size at  $\alpha=0.05$ , the data were assumed to be normally distributed. The examples discussed below illustrate this test.

Table C-1 presents two example data sets for primary objective P2 that were tested for normality. Figures C-1 and C-2 provide Statistix<sup>®</sup> Wilk-Shapiro test outputs for these data sets. The calculated W values for S1A2 and S2A2 were 0.9509 and 0.6740, respectively. At  $\alpha=0.05$ , the critical W values for S1A2 and S2A2 were 0.818 and 0.905, respectively. Because the calculated W value for S1A2 was greater than the critical W value, the S1A2 data for primary objective P2 were considered to be normally distributed. The opposite was true for S2A2 data.

**Table C-1. Data Sets for Example Wilk-Shapiro Test Calculations**

Demonstration Area	Depth Interval (inches bss)	Core Length (inches)																	
		7	3	8	7	8	5	11	6										
S1A2 (freshwater bay)	12 to 32	7	3	8	7	8	5	11	6										
S2A2 (wetland)	4 to 12	1.5	8	0	1	0	0	0	0	0	2.5	0	0	0	0	7	4	8	8

Note:

bss = Below sediment surface

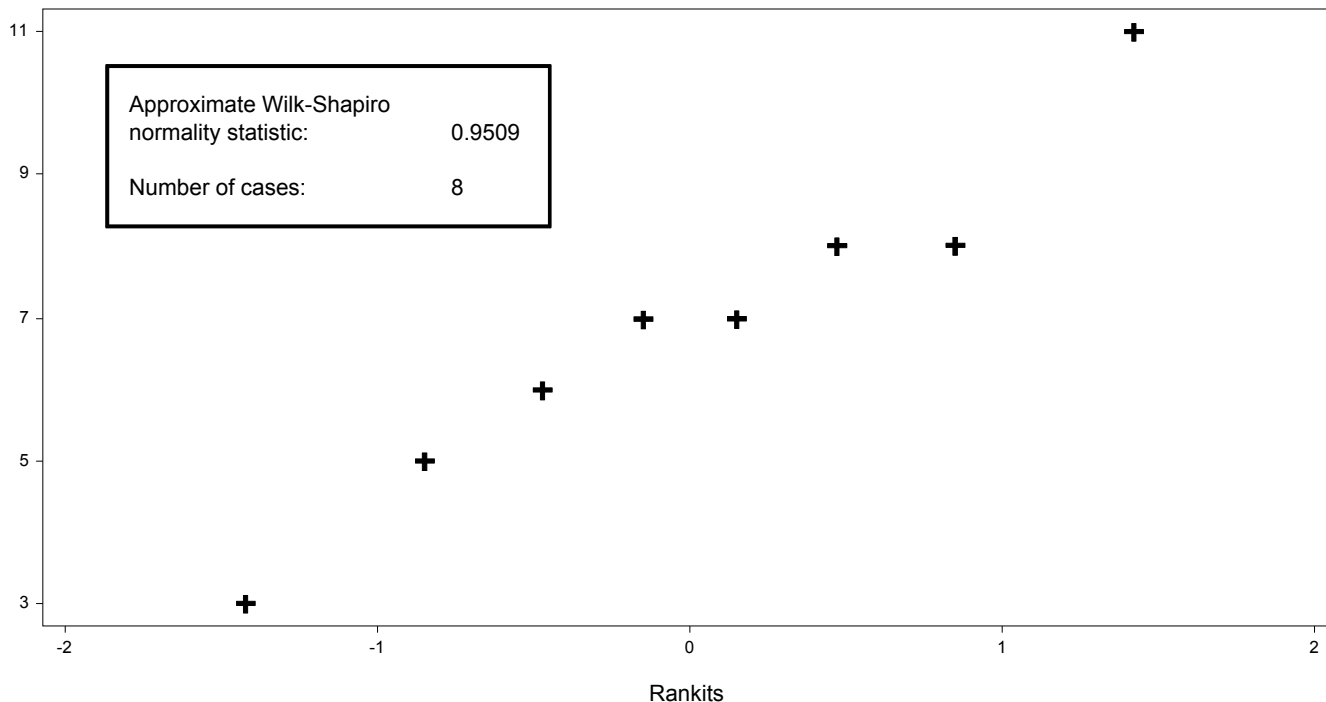

**Figure C-1. Wilk-Shapiro test plot for core length measurements in S1A2 (freshwater bay).**

### C.2 Wilcoxon Signed Rank Test

The Wilcoxon signed rank test is a nonparametric test for paired samples that makes no assumptions regarding the distribution of data. This test was selected to evaluate the demonstration results for primary objectives P1, P2, and P4 as an alternative to the paired Student’s t-test, which was originally prescribed in the demonstration plan under the assumption that the demonstration results would be normally or lognormally distributed. The Wilcoxon signed rank test was selected for evaluating the project data because the Wilk-Shapiro test indicated that most of

the data sets were neither normally nor lognormally distributed.

The primary limitation of the Wilcoxon signed rank test is that it lacks the power of the Student’s t-test because it does not consider the magnitude of the difference between sample pair results. For example, the test cannot distinguish the difference between one pair in which the expected core length was 8 inches and the actual core length was 7.5 inches and another pair in which the expected and actual core lengths were 8 and 0 inches, respectively. Instead, the test first evaluates how many pairs in a given data set have positive, negative, or zero differences and then uses this information to test the

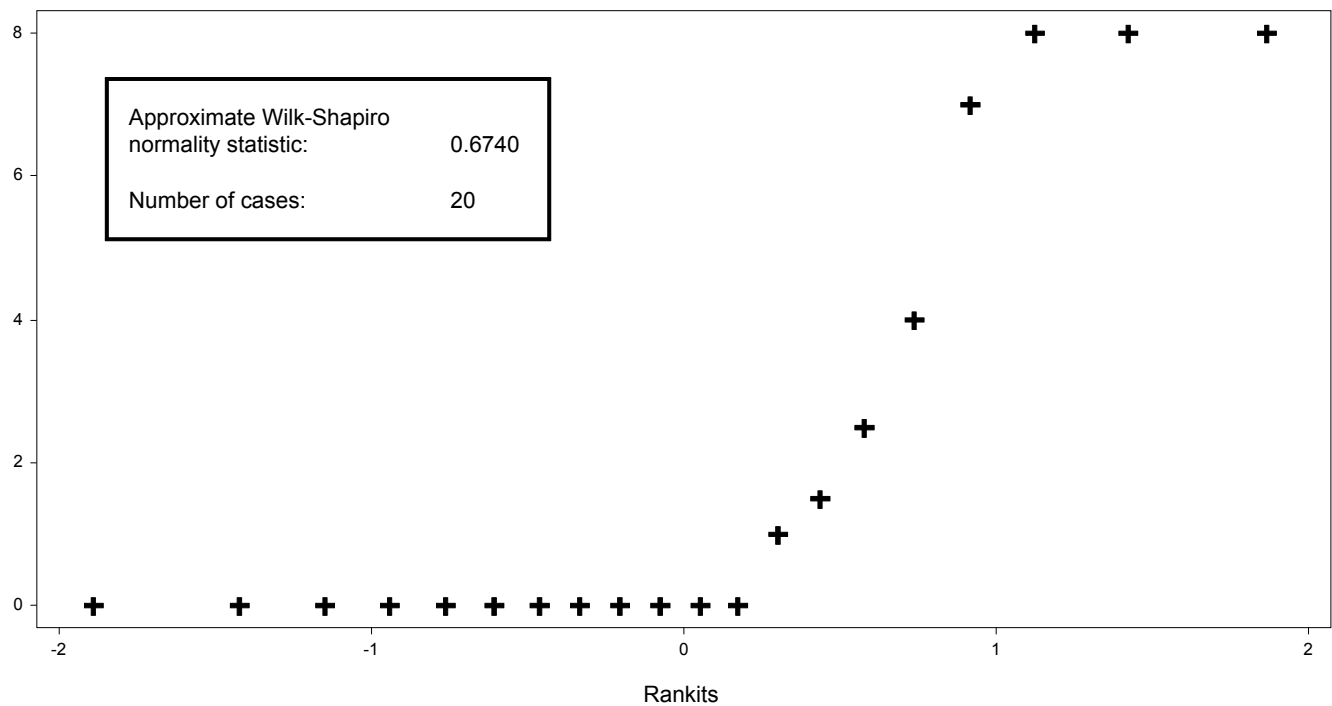

Figure C-2. Wilk-Shapiro test plot for core length measurements in S2A2 (wetland).

hypothesis. In addition, the test ignores cases in which the expected and actual core lengths are the same.

The Wilcoxon signed rank test was performed using the Statistix<sup>®</sup> software package, which calculated the probability value (p-value) at which the null hypothesis was true. The p-value was compared to an  $\alpha$  of 0.05 to determine whether the null hypothesis should be accepted or rejected. If the p-value exceeded  $\alpha$ , it was concluded that the mean difference for the paired results was not statistically significant; otherwise, it was concluded that the difference was statistically significant.

Several conclusions drawn from the Wilcoxon signed rank test results for primary objectives P1 and P2 did not seem to be correct based on the magnitude of the differences observed for sample pairs in a given data set. However, the results for primary objective P4 were evaluated using this test because no such problem was observed. To illustrate this point, example calculations are presented below.

Table C-2 and Figure C-3 provide the primary objective P1 Hand Corer sample data set for the 4- to 12-inch bss

depth interval in S2A2 and the corresponding Statistix<sup>®</sup> output for the Wilcoxon signed rank test, respectively. The test calculated a one-tailed p-value of 0.0625, indicating that the difference between the expected and actual number of attempts was not statistically significant (the null hypothesis was that the mean difference between the expected and actual values equals zero). Because the expected and actual values differed for four of the five sample pairs and particularly for the second pair, the difference was in fact considerable. Therefore, the conclusion drawn from the Wilcoxon signed rank test appears to be incorrect.

Table C-2. Hand Corer Sample Data for 4- to 12-Inch Below Sediment Surface Depth Interval in S2A2 (Wetland)

Expected Number of Attempts	Actual Number of Attempts
1	2
1	12
1	3
1	2
1	1

**4- to 12-inch below sediment surface depth interval**

STATISTIX FOR WINDOWS		8/3/99, 4:44:45 PM
WILCOXON SIGNED RANK TEST FOR S2A2_4_12 - G		
SUM OF NEGATIVE RANKS		0.0000
SUM OF POSITIVE RANKS		10.000
EXACT PROBABILITY OF A RESULT AS OR MORE EXTREME THAN THE OBSERVED RANKS (1 TAILED P-VALUE)		
		0.0625
NORMAL APPROXIMATION WITH CONTINUITY CORRECTION		
		1.643
TWO-TAILED P-VALUE for NORMAL APPROXIMATION		
		0.1003
TOTAL NUMBER OF VALUES THAT WERE TIED	2	
NUMBER OF ZERO DIFFERENCES DROPPED	1	
MAX. DIFF. ALLOWED BETWEEN TIES	0.00001	
CASES INCLUDED	4	MISSING CASES 6

**Figure C-3. Statistix® output for Hand Corer sample data for S2A2 (wetland).**

Table C-3 and Figure C-4 provide the primary objective P4 Hand Corer and Russian Peat Borer sample data for the 10- to 30-inch bss depth interval in S2A1 and the corresponding Statistix® output for the Wilcoxon signed rank test, respectively. The test calculated a two-tailed p-value of 0.6103, indicating that the difference between the two sets of arsenic results was not statistically

significant (the null hypothesis was that the mean difference between the innovative and reference sampler sample analytical results for the clean layer equals zero). Because the arsenic results for the Russian Peat Borer samples were greater than those for the Hand Corer samples in 7 of the 10 pairs and less in 3 of the 10 pairs, the conclusion drawn from the Wilcoxon signed rank test appears to be correct.

**Table C-3. Hand Corer and Russian Peat Borer Sample Data for 10- to 30-inch Below Sediment Surface Depth Interval in S2A1 (Lake)**

Sampler	Arsenic Concentrations (milligrams per kilogram)									
Hand Corer	24	8.5	16	8.3	9.7	13	7.2	7.2	8.2	52
Russian Peat Borer	12	9	29	10	18	10	14	11	9.9	11

**10- to 30-inch below sediment surface depth interval**

STATISTIX FOR WINDOWS	8/19/99, 3:19:04 PM
WILCOXON SIGNED RANK TEST FOR REFERENCE - IS1	
SUM OF NEGATIVE RANKS	-33.000
SUM OF POSITIVE RANKS	22.000
EXACT PROBABILITY OF A RESULT AS OR MORE EXTREME THAN THE OBSERVED RANKS (1 TAILED P-VALUE)	
	0.3262
NORMAL APPROXIMATION WITH CONTINUITY CORRECTION	
	0.510
TWO-TAILED P-VALUE for NORMAL APPROXIMATION	
	0.6103
TOTAL NUMBER OF VALUES THAT WERE TIED	2
NUMBER OF ZERO DIFFERENCES DROPPED	0
MAX. DIFF. ALLOWED BETWEEN TIES	0.00001
CASES INCLUDED 10	MISSING CASES 2

Figure C-4. Statistix® output for Hand Corer and Russian Peat Borer sample data for S2A1 (lake).

**C.3 References**

Analytical Software. 1996. Statistix® for Windows. Version 2.0. Tallahassee, Florida.

Gilbert, R. 1987. *Statistical Methods for Environmental Pollution Monitoring*. Van Nostrand Reinhold Company, Inc. New York, New York.