

US EPA ARCHIVE DOCUMENT

April 2005
05/20/WQPC-WWF
EPA 600/R-05/099

Environmental Technology Verification Report

Stormwater Source Area
Treatment Device

Stormwater Management, Inc.
StormScreen[®] Treatment System

Prepared by



NSF International

Under a Cooperative Agreement with
 EPA U.S. Environmental Protection Agency

ET ✓ ET ✓ ET ✓

Environmental Technology Verification Report

Stormwater Source Area Treatment Device

**Stormwater Management, Inc.
StormScreen[®] Treatment System**

Prepared by:
NSF International
Ann Arbor, Michigan 48105
and
Scherger Associates
Ann Arbor, Michigan 48105

Under a cooperative agreement with the U.S. Environmental Protection Agency

Raymond Frederick, Project Officer
ETV Water Quality Protection Center
National Risk Management Research Laboratory
Water Supply and Water Resources Division
U.S. Environmental Protection Agency
Edison, New Jersey 08837

April 2005

THE ENVIRONMENTAL TECHNOLOGY VERIFICATION PROGRAM



U.S. Environmental Protection Agency



NSF International

ETV Joint Verification Statement

TECHNOLOGY TYPE:	STORMWATER TREATMENT TECHNOLOGY	
APPLICATION:	SUSPENDED SOLIDS AND ROADWAY POLLUTANT TREATMENT	
TECHNOLOGY NAME:	THE STORMWATER MANAGEMENT STORMSCREEN® TREATMENT SYSTEM	
TEST LOCATION:	GRIFFIN, GEORGIA	
COMPANY:	STORMWATER MANAGEMENT, INC.	
ADDRESS:	12021-B NE Airport Way Portland, Oregon 97220	PHONE: (800) 548-4667 FAX: (503) 240-9553
WEBSITE:	http://www.stormwaterinc.com	
EMAIL:	mail@stormwaterinc.com	

NSF International (NSF), in cooperation with the U.S. Environmental Protection Agency (EPA), operates the Water Quality Protection Center (WQPC), one of six centers under the Environmental Technology Verification (ETV) Program. The WQPC recently evaluated the performance of the Stormwater Management StormScreen® (StormScreen) manufactured by Stormwater Management, Inc. (SMI). The system was installed in a city-owned right-of-way near downtown Griffin, Georgia. Paragon Consulting Group (PCG) performed the testing.

EPA created ETV to facilitate the deployment of innovative or improved environmental technologies through performance verification and dissemination of information. The goal of the ETV Program is to further environmental protection by accelerating the acceptance and use of improved and more cost-effective technologies. ETV seeks to achieve this goal by providing high quality, peer-reviewed data on technology performance to those involved in the design, distribution, permitting, purchase, and use of environmental technologies.

ETV works in partnership with recognized standards and testing organizations; stakeholder groups, which consist of buyers, vendor organizations, and permittees; and with the full participation of individual technology developers. The program evaluates the performance of innovative technologies by developing test plans that are responsive to the needs of stakeholders, conducting field or laboratory tests (as appropriate), collecting and analyzing data, and preparing peer-reviewed reports. All evaluations are conducted in accordance with rigorous quality assurance protocols to ensure that data of known and adequate quality are generated and that the results are defensible.

TECHNOLOGY DESCRIPTION

The following description of the StormScreen was provided by the vendor and does not represent verified information.

The StormScreen is a device that removes trash, debris, and large suspended particulates at high flow rates. The StormScreen consists of an inlet bay, cartridge bay, and outlet bay, housed in a 16-ft by 8-ft precast concrete vault. The inlet bay serves as a grit chamber and provides for flow transition into the cartridge bay, where the water is screened and discharged through flumes to the outlet bay and the outlet pipe.

The StormScreen is equipped with 20 cartridges (four discharge flumes with five cartridges per flume). The cartridges are equipped with screens with a standard opening size of 2.4 mm. The cartridges screen water by combining direct screening with many of the hydraulic aspects of the siphonic, radial-flow cartridge system patented by SMI. Water in the cartridge bay passes through the cartridge screen and into a tube in the center of the cartridge. When the center tube fills, a float valve opens and a check valve on top of the cartridge closes, creating a siphon that draws water through the screens. The treated water drains into the discharge flume to the outlet bay, where it exits the system through the discharge pipe. The system resets when the cartridge bay is drained and the siphon is broken. Screened solids accumulate in the debris sump in the cartridge bay. Each cartridge has a design flow capacity of 0.5 cfs (224 gpm), so the unit as a whole has a design flow capacity of 10 cfs (4,488 gpm).

Flows exceeding the capacity of the StormScreen are diverted by an SMI StormGate™ installed upstream of the StormScreen. The StormGate™ has a field-adjustable weir in a precast cylindrical concrete vault. Flows with a depth lower than the weir elevation are diverted to the StormScreen, while flows with a depth greater than the weir elevation are discharged to a bypass pipe. The weir at this installation was set at an elevation to direct a 10 cfs flowrate to the StormScreen.

SMI claims that the StormScreen will function at design flow when up to 85 percent occluded, and will remove all particles greater than 2.4 mm in diameter. The StormScreen performance for pollutant removal is dependent on site conditions, sediment loading, particle size distribution, and environmental variables.

VERIFICATION TESTING DESCRIPTION

Methods and Procedures

The test methods and procedures used during the study are described in the *Test Plan for The Stormwater Management StormScreen, TEA-21 Project Area, Griffin, Georgia* (NSF International and PCG, June 2003) (test plan). The City of Griffin requires that all storm drain systems be sized to pass peak flows from a 25-yr storm without causing surface flooding. For a 25-yr storm, a 5.42-min time of concentration was determined for the drainage basin, generating a peak runoff of 46.80 cfs. The rational method was used to calculate the peak flows for the system.

Verification testing consisted of collecting data during a minimum of fifteen qualified events that met the following criteria:

- The total rainfall depth for the event, measured at the site, was 0.2 in. (5 mm) or greater;
- Flow through the treatment device was successfully measured and recorded over the duration of the runoff period;
- There was a minimum of six hours between qualified sampling events; and
- Visual observations were noted for the inlet bay, cartridge chamber, and effluent chamber.

The ETV protocol for stormwater treatment technologies does not include any specific quantitative measurements for technologies, such as the StormScreen, claiming trash and debris removal. The only approach for verification of this type of technology is to use visual observations by the testing organization, documented with photographs and field observations logs. This information along with basic flow data is the basis for evaluating technologies claiming trash and debris removal.

Automated flow monitoring equipment was installed to measure the total flow entering the StormGate™, and the treated flow exiting the StormScreen. In addition to the flow data, visual observations of the inside of the unit and operation and maintenance (O&M) data were recorded.

VERIFICATION OF PERFORMANCE

Verification testing of the StormScreen lasted approximately nine months, and fifteen events were evaluated.

Test Results

The fifteen events used for this verification test covered a wide range of storms with total rainfall amounts varying from 0.22 in. to 3.06 in. The storms also varied in peak intensity from 0.12 in./hr to 21.6 in./hr. Some storms were short and intense, while others were longer and less intense. The precipitation data for the fifteen rain events are summarized in Table 1.

Table 1. Rainfall and StormScreen Performance Data Summary

Event Number	Start Date	Start Time	Rainfall Amount (in.)	Rainfall Duration (hr:min)	Runoff Volume (ft ³) ¹	Peak Flow Rate (gpm)		Volume Bypassed (Percent of Inlet Flow)
						Inlet	Outlet	
1	05/21/03	16:35	2.16	12:25	29,000	3,780	320	20
2	06/03/03	05:50	0.40	03:40	3,610	2,580	380	0 ²
3	07/03/03	17:10	0.45	00:15	4,210	1,630	160	62
4	08/12/03	17:10	0.22	00:10	2,020	1,590	360	15
5	09/04/03	13:50	0.22	01:30	2,170	630	520	0 ²
6	09/22/03	14:45	3.06	06:15	30,800	3,730	410	69
7	10/07/03	23:30	0.53	06:10	4,660	1,450	340	24
8	10/26/03	10:10	0.28	09:30	2,750	890	350	0 ²
9	11/05/03	15:45	0.74	01:55	6,350	2,430	340	69
10	11/19/03	01:25	1.52	03:20	15,600	5,250	590	74
11	11/27/03	15:55	0.74	06:30	9,520	550	540	0 ²
12	12/10/03	02:20	0.54	04:05	6,200	430	300	0 ²
13	12/14/03	00:20	0.34	02:20	4,230	1,160	140	63
14	01/05/04	13:10	0.47	05:35	4,970	1,210	250	69
15	01/17/04	20:35	0.44	04:45	4,290	630	320	0

¹ Runoff volume was measured at the inlet monitoring point.

² Some water may have bypassed. However, the elevation/level data at the inlet indicate bypass did not occur since the water level did not exceed the weir elevation. Volume differences are most likely due either to possible outlet meter negative bias or inlet meter positive bias during surcharge conditions.

The flow data and observations indicated that the maximum flow through the StormScreen during the verification testing was considerably lower than the design flow capacity. In at least nine events, some bypass occurred at runoff flowrates less than the anticipated design capacity of the StormScreen unit. The flow data from the StormScreen outlet shows that the unit was typically treating between 150 to 250 gpm when the system was flowing at a steady rate. Each event had a peak discharge rate (typically 300 to 600 gpm) that was higher than the steady rate, but still significantly below the design flow capacity of 4,488 gpm (10 cfs). These peak rates were preceded or followed by periods of time (5 to 30 min) when the unit was running at a fairly steady rate as it processed the water that had entered and accumulated in the StormScreen and StormGate™. The StormScreen appeared to process more water when the levels in the StormGate™ were higher, indicating more water was entering the StormScreen.

An accumulation of trash and debris was observed in the cartridge bay after every event. Furthermore, sediment and a hydrocarbon sheen were observed in the fore bay and cartridge bay after most events. The cartridge hoods were covered with sediment and debris, and the estimated sediment depth continued to increase over the nine months that flow measurements and observations were collected. By the end of the test, the screens were occluded by a significant quantity of organic detritus and fine clay.

After the verification testing was complete, SMI conducted a test on the StormScreen to try to determine why the design flowrates were not achieved during the ETV study. The first was conducted at the time the StormScreen was cleaned out, in the presence of the testing organization (TO) and NSF. It involved thorough cleaning of cartridges for one of the four discharge flumes, and running potable water into the cartridge bay. The maximum flowrate through the cleaned discharge flume was approximately 0.8 cfs (360 gpm), or 3.2 cfs (1,440 gpm) for four discharge flumes. This peak flow rate is greater than any peak rates measured during verification test, but is significantly lower than SMI's rated peak flow capacity of 10 cfs (4,488 gpm). However, the potable water supply was shut off at the request of the City of Griffin before the water in the vault reached the maximum elevation where the flume would discharge at its maximum flowrate.

An additional study was performed by SMI on a StormScreen installed at their Portland, Oregon, facility. This study was conducted with no oversight by the TO or NSF; therefore, the findings do not represent ETV-verified data. The study first established a relationship between the discharge rate and the water elevation in the cartridge bay. Then, clean water was pumped into the StormScreen cartridge bay at the design flow rate. A detailed description of the testing procedures and results is included in the vendor comments section of the verification report.

Based on the findings of the ETV test and the vendor's subsequent studies, the occlusion of the cartridge screens by organic detritus and fine clay apparently resulted in the decrease in the StormScreen's flow capacity at this installation. SMI concluded that a more frequent maintenance schedule, including cleaning the cartridge screens, would have been required to achieve a higher flow capacity for this application.

System Operation

The StormScreen was installed on May 9, 2002, prior to the planned start of ETV verification testing, and operated for one year prior to the start of verification testing. The StormScreen was cleaned in February 2003 after nine months of operation and prior to the start of the verification test in May 2003. There were no apparent mechanical problems with the unit.

On May 13, 2004, SMI, under the supervision of PCG, conducted a thorough cleanout of the StormScreen, including an assessment of all the retained solids. The assessment revealed that 4,020 lb (wet weight) were retained. The retained material had a mean moisture content of 71% by weight, resulting in a calculated dry weight total of 1,160 lb of retained solids.

Quality Assurance/Quality Control

NSF personnel completed a technical systems audit during testing to ensure that the testing was in compliance with the test plan. NSF also completed a data quality audit of 100% of the test data to ensure that the reported data represented the data generated during testing. In addition to QA/QC audits performed by NSF, EPA personnel conducted an audit of NSF's QA Management Program.

Original signed by
Sally Gutierrez September 2, 2005
 Sally Gutierrez Date
 Director
 National Risk Management Laboratory
 Office of Research and Development
 United States Environmental Protection Agency

Original signed by
Thomas Stevens September 7, 2005
 Thomas G. Stevens, P.E. Date
 Program Manager
 ETV Water Quality Protection Center
 NSF International

NOTICE: Verifications are based on an evaluation of technology performance under specific, predetermined criteria and the appropriate quality assurance procedures. EPA and NSF make no expressed or implied warranties as to the performance of the technology and do not certify that a technology will always operate as verified. The end user is solely responsible for complying with any and all applicable federal, state, and local requirements. Mention of corporate names, trade names, or commercial products does not constitute endorsement or recommendation for use of specific products. This report is not an NSF Certification of the specific product mentioned herein.

Availability of Supporting Documents
 Copies of the *ETV Verification Protocol, Stormwater Source Area Treatment Technologies Draft 4.1, March 2002*, the verification statement, and the verification report (NSF Report Number 05/20/WQPC-WWF) are available from:
 ETV Water Quality Protection Center Program Manager (hard copy)
 NSF International
 P.O. Box 130140
 Ann Arbor, Michigan 48113-0140
 NSF website: <http://www.nsf.org/etv> (electronic copy)
 EPA website: <http://www.epa.gov/etv> (electronic copy)
 Appendices are not included in the verification report, but are available from NSF upon request.

Notice

The U.S. Environmental Protection Agency (EPA) through its Office of Research and Development has financially supported and collaborated with NSF International (NSF) under a Cooperative Agreement. The Water Quality Protection Center (WQPC), operating under the Environmental Technology Verification (ETV) Program, supported this verification effort. This document has been peer reviewed, reviewed by NSF and EPA, and recommended for public release. Mention of trade names or commercial products does not constitute endorsement or recommendation by the EPA.

Foreword

The following is the final report on an Environmental Technology Verification (ETV) test performed for NSF International (NSF) and the United States Environmental Protection Agency (EPA). The verification test for the Stormwater Management, Inc. StormScreen[®] Treatment System was conducted at a testing site in Griffin, Georgia, maintained by the City of Griffin Public Works and Stormwater Department.

The EPA is charged by Congress with protecting the Nation's land, air, and water resources. Under a mandate of national environmental laws, the Agency strives to formulate and implement actions leading to a compatible balance between human activities and the ability of natural systems to support and nurture life. To meet this mandate, EPA's research program is providing data and technical support for solving environmental problems today and building a science knowledge base necessary to manage our ecological resources wisely, understand how pollutants affect our health, and prevent or reduce environmental risks in the future.

The National Risk Management Research Laboratory (NRMRL) is the Agency's center for investigation of technological and management approaches for preventing and reducing risks from pollution that threaten human health and the environment. The focus of the Laboratory's research program is on methods and their cost-effectiveness for prevention and control of pollution to air, land, water, and subsurface resources; protection of water quality in public water systems; remediation of contaminated sites, sediments, and groundwater; prevention and control of indoor air pollution; and restoration of ecosystems. NRMRL collaborates with both public and private sector partners to foster technologies that reduce the cost of compliance and to anticipate emerging problems. NRMRL's research provides solutions to environmental problems by: developing and promoting technologies that protect and improve the environment; advancing scientific and engineering information to support regulatory and policy decisions; and providing the technical support and information transfer to ensure implementation of environmental regulations and strategies at the national, state, and community levels.

This publication has been produced as part of the Laboratory's strategic long-term research plan. It is published and made available by EPA's Office of Research and Development to assist the user community and to link researchers with their clients.

Contents

Verification Statement	VS-i
Notice	i
Foreword	ii
Contents	iii
Figures	iv
Tables	v
Abbreviations and Acronyms	vi
Chapter 1 Introduction	1
1.1 ETV Purpose and Program Operation	1
1.2 Testing Participants and Responsibilities	1
1.2.1 U.S. Environmental Protection Agency	2
1.2.2 Verification Organization	2
1.2.3 Testing Organization	3
1.2.4 Analytical Laboratories	4
1.2.5 Vendor	4
1.2.6 City of Griffin—Verification Testing Site	5
Chapter 2 Technology Description	6
2.1 Treatment System Description	6
2.1.1 StormGate	7
2.2 Screening Process	8
2.3 Product Specifications	9
2.4 Operation and Maintenance	10
2.5 Technology Application and Limitations	10
2.6 Performance Claim	10
Chapter 3 Test Site Description	11
3.1 Location and Land Use	11
3.2 Stormwater Conveyance System and Receiving Water	14
3.3 Rainfall and Peak Flow Calculations	14
3.4 StormGate and StormScreen Installation	15
Chapter 4 Sampling Procedures and Analytical Methods	16
4.1 Introduction	16
4.2 Sampling Events and Qualification Criteria	17
4.3 Constituent Selection	17
4.4 Visual Observations	17
4.5 Flow Measurement	17
4.6 Precipitation Measurement	18
4.6.1 Methods	18
4.6.2 Field Procedures	18
4.7 Operation and Maintenance Parameters	18
Chapter 5 Monitoring Results and Discussion	20
5.1 Monitoring Results—Flow and Rainfall Data	20
5.1.1 Flow Verification	27
5.2 Observations of StormScreen Performance—Trash and Debris Removal	28
5.3 Operation and Maintenance	37
5.4 Trash, Debris, and Solids Removal	38

5.4.1	Weight of Solids Removed	38
5.4.2	TCLP Results	40
Chapter 6	QA/QC Results and Summary	42
6.1	Laboratory Data QA/QC	42
6.1.1	Precision	42
6.1.2	Accuracy.....	43
6.2	Field Flow Measurements	44
6.3	Quality Assurance Reports.....	44
Chapter 7	Vendor-Supplied Information	45
7.1	Testing Equipment	45
7.2	Stage/Discharge Relationship Test without Float Valves.....	47
7.2.1	Procedure.....	47
7.2.2	Results	48
7.3	Stage/Discharge Relationship Test with Float Valves.....	49
7.3.1	Procedure.....	49
7.3.2	Results	49
7.4	Conclusion.....	50
Chapter 8	References	51
Glossary	52
Appendices	54
A	SMI Design and O&M Guidelines	54
B	Verification Test Plan	54
C	Standard Operating Procedure for Solids Cleanout.....	54
D	Event Hydrographs and Rain Distribution.....	54
E	Observation Forms and Photographs.....	54
F	Analytical Data Reports with QC	54

Figures

Figure 2-1.	Schematic of a StormScreen Treatment System.....	6
Figure 2-2.	Schematic of the StormGate.....	8
Figure 2-3.	StormScreen cartridge.....	9
Figure 3-1.	Drainage basin map with contours for StormScreen.....	12
Figure 3-2.	As-built drawing of StormScreen and storm drain system.....	13
Figure 5-1.	Inlet and StormScreen outlet hydrographs, May 21-22, 2003.....	23
Figure 5-2.	Inlet and StormScreen outlet hydrographs, September 4, 2003.....	24
Figure 5-3.	Inlet and StormScreen outlet hydrographs, December 10, 2003.....	25
Figure 5-4.	Photographs from flow test.....	28
Figure 5-5.	Example StormScreen field observation form.....	31
Figure 5-6.	StormScreen photographs, May through August 2003.....	32
Figure 5-7.	StormScreen photographs, August through September 2003.....	33
Figure 5-8.	StormScreen photographs, September through October 2003.....	34
Figure 5-9.	StormScreen photographs, November 2003.....	35
Figure 5-10.	StormScreen photographs, January 2004.....	36
Figure 7-1.	StormScreen testing and demonstration system.....	46

Figure 7-2. Electrically actuated control valve and in-line flowmeter.	46
Figure 7-3. Effluent bay of StormScreen testing vault, showing rectangular discharge flume and 8-in return pipe to reservoir.	47
Figure 7-4. StormScreen stage versus flow relationship without float valves.	48
Figure 7-5. StormScreen stage versus flow relationship with float valves.	50

Tables

Table 3-1. Rainfall Amount (in.)	14
Table 3-2. Rainfall Intensities (in/hr).....	14
Table 3-3. Calculated Peak Flowrates (cfs)	15
Table 3-4. Calculated Peak Flowrates (cfs) Using Time of Concentration	15
Table 4-1. Testing Method, Detection Limit, and Holding Time for TCLP and Metals.....	19
Table 5-1. Rainfall Summary for Monitored Events	20
Table 5-2. Runoff and Treated Water Volume Summary.....	21
Table 5-3. Event Maximum Flowrate and Maximum Level	22
Table 5-4. Summary of Field Observations.....	30
Table 5-5. Percent Solids of Solids Removed from StormScreen.....	40
Table 5-6. TCLP Results for Cleanout Solids	41
Table 6-1. Analytical Precision Summary	43
Table 6-2. Summary of Replicate Percent Solids Results	43
Table 6-3. Laboratory Control Sample Results	44

Abbreviations and Acronyms

ASI	Analytical Services, Inc.
BMP	Best Management Practice
cfs	Cubic feet per second
EPA	U.S. Environmental Protection Agency
ETV	Environmental Technology Verification
ft ²	Square feet
ft ³	Cubic feet
gal	Gallon
gpm	Gallon per minute
hr	Hour
in.	Inch
kg	Kilogram
L	Liter
lb	Pound
NRMRL	National Risk Management Research Laboratory
mg/L	Milligram per liter
mm	Millimeter
NSF	NSF International
O&M	Operations and maintenance
PCG	Paragon Consulting Group
QA	Quality assurance
QC	Quality control
SMI	Stormwater Management, Inc.
SOP	Standard Operating Procedure
TCLP	Toxicity Characteristics Leaching Procedure
TO	Testing Organization
VO	Verification Organization (NSF)
WQPC	Water Quality Protection Center

Chapter 1

Introduction

1.1 ETV Purpose and Program Operation

The U.S. Environmental Protection Agency (EPA) has created the Environmental Technology Verification (ETV) Program to facilitate the deployment of innovative or improved environmental technologies through performance verification and dissemination of information. The goal of the ETV program is to further environmental protection by substantially accelerating the acceptance and use of improved and more cost-effective technologies. ETV seeks to achieve this goal by providing high-quality, peer-reviewed data on technology performance to those involved in the design, distribution, permitting, purchase, and use of environmental technologies.

ETV works in partnership with recognized standards and testing organizations; stakeholder groups, which consist of buyers, vendor organizations, and permittees; and with the full participation of individual technology developers. The program evaluates the performance of innovative technologies by developing test plans that are responsive to the needs of stakeholders, conducting field or laboratory testing (as appropriate), collecting and analyzing data, and preparing peer-reviewed reports. All evaluations are conducted in accordance with rigorous quality assurance protocols to ensure that data of known and adequate quality are generated and that the results are defensible.

NSF International (NSF), in cooperation with the EPA, operates the Water Quality Protection Center (WQPC). The WQPC evaluated the performance of the Stormwater Management, Inc. StormScreen[®] Treatment System (StormScreen), a stormwater treatment system designed to remove trash, debris, and large particulates from wet weather runoff.

It is important to note that verification of the equipment does not mean that the equipment is “certified” by NSF or “accepted” by EPA. Rather, it recognizes that the performance of the equipment has been determined and verified by these organizations for those conditions tested by the testing organization (TO).

1.2 Testing Participants and Responsibilities

The ETV testing of the StormScreen was a cooperative effort among the following participants:

- U.S. Environmental Protection Agency
- NSF International
- Paragon Consulting Group, Inc. (PCG)
- Analytical Services, Inc. (ASI)
- Stormwater Management, Inc. (SMI)
- City of Griffin, Georgia

The following is a brief description of the ETV participants and their roles and responsibilities.

1.2.1 U.S. Environmental Protection Agency

The EPA Office of Research and Development, through the Urban Watershed Branch, Water Supply and Water Resources Division, National Risk Management Research Laboratory (NRMRL), provides administrative, technical, and quality assurance guidance and oversight on all ETV WQPC activities. In addition, EPA provides financial support for operation of the Center and partial support for the cost of testing for this verification.

EPA was responsible for the following:

- Review and approval of the verification test plan;
- Review and approval of the verification report;
- Review and approval of the verification statement; and
- Post the verification report and statement on the EPA website.

The key EPA contact for this program is:

Mr. Ray Frederick, ETV WQPC Project Officer
(732) 321-6627
email: Frederick.Ray@epamail.epa.gov

U.S. EPA, NRMRL
Urban Watershed Management Research Laboratory
2890 Woodbridge Avenue (MS-104)
Edison, New Jersey 08837-3679

1.2.2 Verification Organization

NSF is the verification organization (VO) administering the WQPC in partnership with EPA. NSF is a not-for-profit testing and certification organization dedicated to public health, safety, and protection of the environment. Founded in 1946 and located in Ann Arbor, Michigan, NSF has been instrumental in the development of consensus standards for the protection of public health and the environment. NSF also provides testing and certification services to ensure that products bearing the NSF name, logo and/or Mark meet those standards.

NSF personnel provided technical oversight of the verification process. NSF provided review of the test plan and was responsible for the preparation of the verification report. NSF contracted with Scherger Associates to provide technical advice during the project and assist with preparation of the verification report. NSF's responsibilities as the VO include:

- Review and comment on the test plan;
- Review quality systems of all parties involved with the TO, and qualify the TO;
- Oversee TO activities related to the technology evaluation and associated laboratory testing;
- Conduct an onsite audit of test procedures;

- Provide quality assurance/quality control (QA/QC) review and support for the TO;
- Oversee the development of the verification report and verification statement; and
- Coordinate with EPA to approve the verification report and verification statement.

Key contacts at NSF are:

Mr. Thomas Stevens, Program Manager
(734) 769-5347
email: stevenst@nsf.org

Mr. Patrick Davison, Project Coordinator
(734) 913-5719
email: davison@nsf.org

NSF International
789 North Dixboro Road
Ann Arbor, Michigan 48105
(734) 769-8010

Mr. Dale A. Scherger, P.E., Technical Consultant
(734) 213-8150
email: daleres@aol.com

Scherger Associates
3017 Rumsey Drive
Ann Arbor, Michigan 48105

1.2.3 Testing Organization

The TO for the verification testing was Paragon Consulting Group, Inc. (PCG) of Griffin, Georgia. The TO was responsible for ensuring that the testing location and conditions allowed for the verification testing to meet its stated objectives. The TO prepared the test plan; oversaw the testing; and managed and reported on the data generated by the testing. TO employees set test conditions, and measured and recorded data during the testing. The TO's Project Manager provided project oversight and reviewed the draft verification report.

PCG had primary responsibility for all verification testing, including:

- Coordinate all testing and observations of the StormScreen in accordance with the test plan;
- Contract with the analytical laboratory and any other subcontractors necessary for implementation of the test plan;
- Provide needed logistical support to the subcontractors, as well as establish a communication network, and schedule and coordinate the activities for the verification testing;
- Manage, evaluate, interpret, and report on data generated during the verification testing; and
- Review the draft verification report.

The key personnel and contacts for the TO are:

Ms. Courtney Nolan, Project Manager
(770) 412-7700
email: cnolan@pcgeng.com

Mr. Brian DeLony, Project Engineer
(770) 412-7700
email: bdelony@pcgeng.com

Paragon Consulting Group
118 North Expressway
Griffin, Georgia 30223

1.2.4 Analytical Laboratories

Analytical Services, Inc. (ASI), located in Norcross, Georgia, analyzed the sediment samples collected during the system cleanout at the end of the verification test.

The key analytical laboratory contact is:

Ms. Christin Ford
(770) 734-4200
email: cford@ASI.com

Analytical Services, Inc.
110 Technology Parkway
Norcross, Georgia 30092

1.2.5 Vendor

Stormwater Management, Inc. (SMI) of Portland, Oregon, is the vendor of the StormScreen, and was responsible for supplying a field-ready system. Vendor responsibilities include:

- Provide the technology and ancillary equipment required for the verification testing;
- Provide technical support during the installation and operation of the technology, including the designation of a representative to conduct onsite inspections during monitoring to ensure the technology is functioning as intended;
- Provide descriptive details about the capabilities and intended function of the technology;
- Review and approve the test plan; and
- Review and comment on the draft verification report and draft verification statement.

The key contact for SMI is:

Mr. James Lenhart
(800) 561-1271
email: jiml@stormwaterinc.com

Stormwater Management, Inc.
12021-B NE Airport Way
Portland, Oregon 97220

1.2.6 City of Griffin—Verification Testing Site

Verification of the StormScreen was completed in conjunction with a Georgia Department of Transportation TEA-21 project. Installation of the system and flow meters used in the verification was provided by the TEA-21 project. The StormScreen was located within the right-of-way on the west side of Fifth Street in Griffin, Georgia. A private contractor, Site Engineering, Inc, installed the system.

The key contact for City of Griffin Public Works and Stormwater Department is:

Mr. Brant Keller, Director
(770) 229-6424
email: bkeller@cityofgriffin.com

Public Works and Stormwater Department
City of Griffin
134 North Hill Street
Griffin, Georgia 30224

Chapter 2 Technology Description

The following technology description was supplied by the vendor and does not represent verified information.

2.1 Treatment System Description

The components installed at this testing site included a StormScreen and a StormGate™ Separator (StormGate). The StormGate was installed upstream of the StormScreen and included a field-adjustable weir, which was set to divert flows up to 10 cubic feet per second (cfs) to the StormScreen. Flows greater than 10 cfs would bypass the StormScreen and discharge to the overflow pipe that reconnected with the storm sewer system downstream of the StormScreen. The performance of the StormGate was not included as part of this verification. Additional technical information on the StormGate is provided in Section 2.2.1.

The StormScreen is a structural system that removes trash, debris, and larger suspended particulate at high flow rates by combining direct screening with many of the hydraulic aspects of the patented siphonic, radial-flow cartridge system. This particular system configuration consists of 20 cartridges, each designed to treat a peak flow of 0.5 cfs (225 gallons per minute), providing a total system treatment capacity of 10 cfs. A schematic of a typical StormScreen is shown in Figure 2-1. The StormScreen consisted of an inlet bay, cartridge bay, and outlet bay, housed in a 16-foot by 8-foot precast concrete vault. The inlet bay serves as a grit chamber and provides for flow transition into the cartridge bay, where the water is screened through the screen cartridges and discharged through flumes to the outlet bay and the outlet pipe.

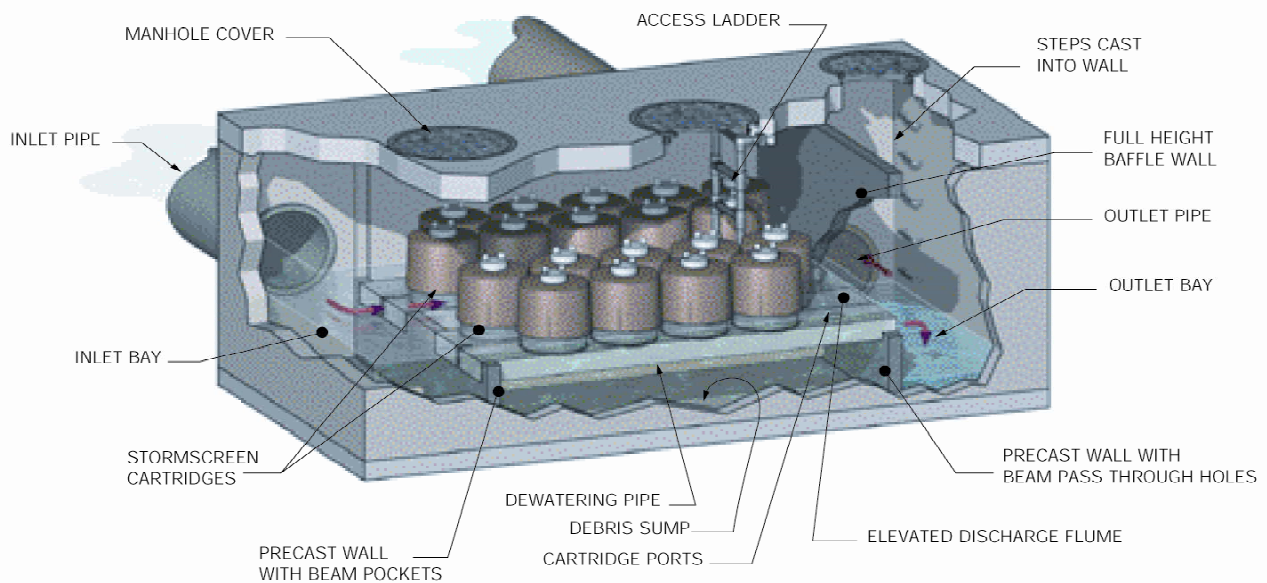

Figure 2-1. Schematic of a StormScreen Treatment System.

A primary feature of the StormScreen is that the use of a screen allows for a much higher treatment rate per cartridge. The StormScreen provides treatment by direct screening through the StormScreen cartridges and by settling within the concrete vault. The standard cartridge screen has a pore opening of 2.4 mm (2,400 microns), which ensures the capture of all solids of greater size. Settling provides some removal of particles smaller than 2.4 mm.

All captured solids are collected in a large sump area on the floor of the vault, located below an elevated discharge flume that supports the cartridges. This sump may be equipped with a dewatering mechanism to provide for ease of maintenance.

The modular design of the StormScreen allows for a variety of system configurations. The system may be designed with a high-flow diversion system (such as the StormGate described above) or, in some special cases, the system may be placed directly on the stormwater conveyance line.

It is also possible to combine the StormScreen with the Stormwater Management StormFilter[®] for a two-stage treatment system, offering higher end treatment of suspended sediments and dissolved pollutants at lower flows, and trash and debris removal at higher flows.

2.1.1 StormGate

The StormGate is a system installed upstream of the StormScreen. It is designed to bypass high-energy flows that exceed the StormScreen, or a similar treatment system's, design capacity. A schematic of a typical StormGate is shown in Figure 2-2.

High flows can reduce the effectiveness of water quality facilities by resuspending sediments and flushing captured floatables, which causes a concentrated pulse of pollutants to be sent to downstream waterways. To minimize the occurrence of pulsing, a high-flow bypass can be installed upstream of water quality or pretreatment facilities to direct the high flow away from the treatment system. The StormGate uses a field-adjustable weir to direct polluted low flows to stormwater treatment systems, while allowing extreme flows to bypass the systems. The StormGate provides tighter control over system hydraulics than other high-flow bypass methods, as changes can be made to the weir elevation once actual field elevations are established or if future design flows change.

The StormGate is provided as a complete manhole or vault unit that installs directly into an existing sewer system. The StormGate installed at the test site on the west side of Fifth Street in Griffin, Georgia, is a standard 48-inch diameter manhole unit connected to the existing 36-inch diameter pipe. SMI provides information on the sizing, construction, and operation of the StormGate in a technical bulletin. This information is presented in Appendix A.

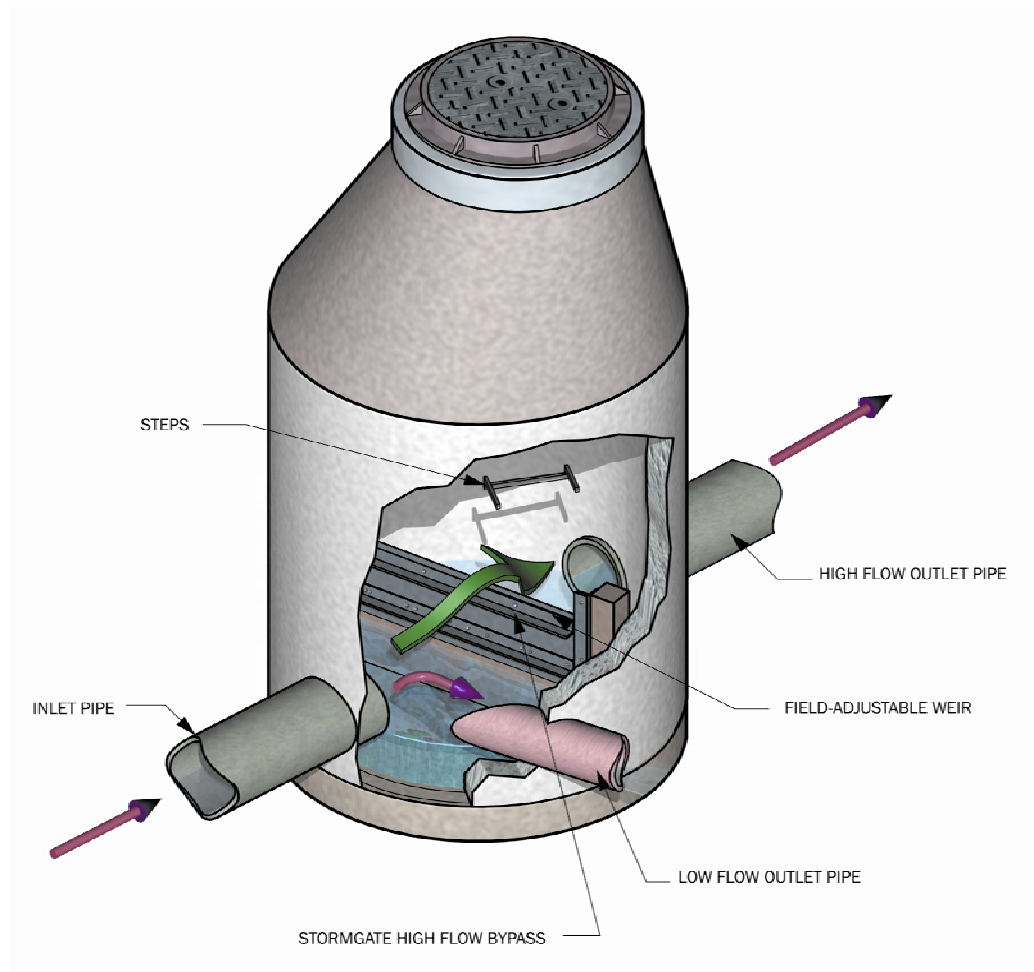

Figure 2-2. Schematic of the StormGate.

2.2 Screening Process

The StormScreen’s screening process works by passing stormwater through 22 gage stainless steel screens having 2.4 mm pore openings and 42 pores per square inch. Each cartridge has a surface area of 7.5 square feet. A diagram identifying the cartridge screen components is shown in Figure 2-3.

Stormwater enters the cartridge bay through the flow spreader, where it ponds. Air in the cartridge is displaced by the water and purged from within the cartridge hood through the one-way check valve located on top of the cap. The water infiltrates through the screen assembly and into the center tube. Once the center tube fills with water, a float valve opens and the water in the center tube flows into the under-drain manifold, located beneath the cartridge. This causes the check valve to close, initiating a siphon that draws stormwater through the cartridge and screen. The siphon continues until the water surface elevation drops to the elevation of the hood’s scrubbing regulators. When the water drains, the float valve closes and the system resets.

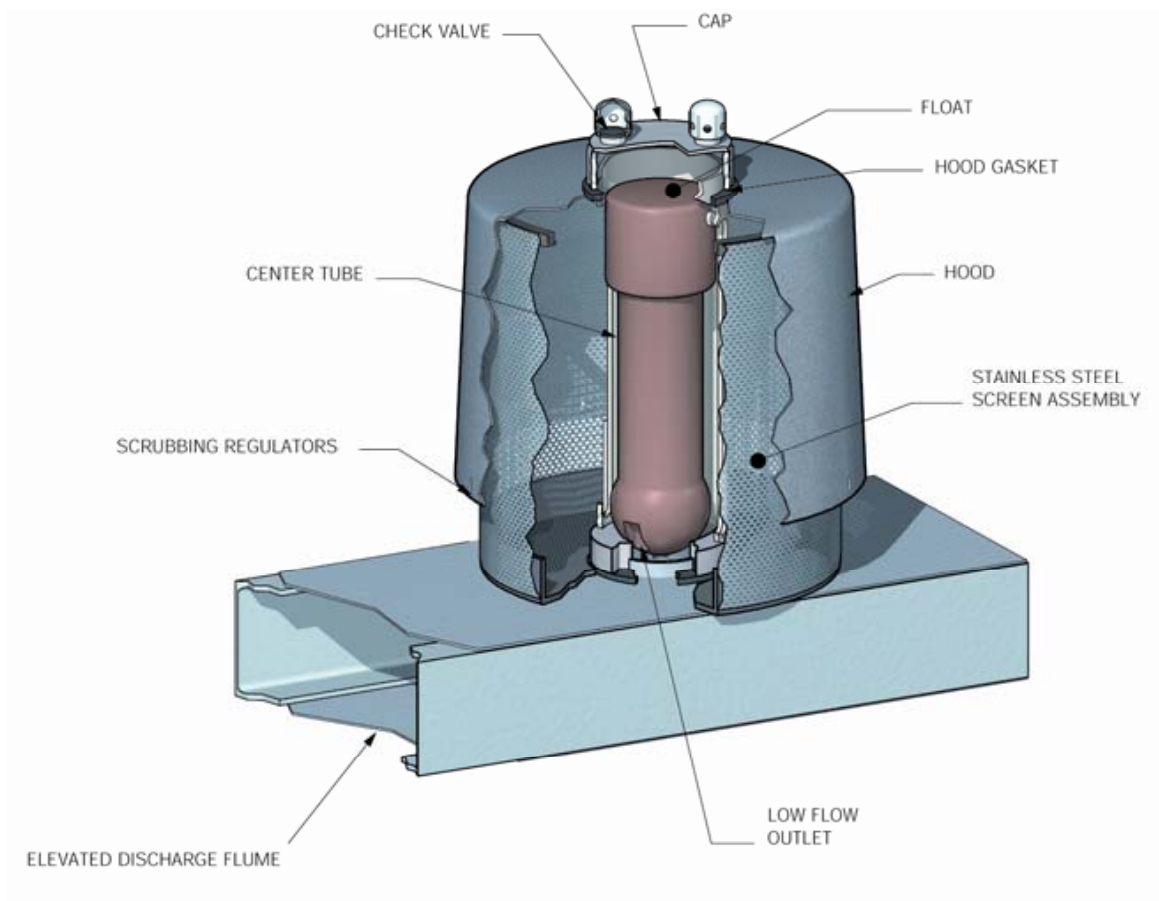

Figure 2-3. StormScreen cartridge.

2.3 Product Specifications

StormScreen:

- Housing – Precast concrete vault
- Dimensions – 16 feet long x 8 feet wide
- Number of Screen Cartridges – 20
- Peak Hydraulic Treatment Capacity – 10 cfs
- Sediment Storage – 5.6 cubic yards
- Sediment Chamber Size – 16 feet by 8 feet

Warranty–All merchandise is warranted against any defect in materials or workmanship provided by SMI, providing a claim is made in writing within one year from the date of delivery of merchandise to the purchaser. SMI’s obligation on any claim is limited to replacement or repair of the defective materials at SMI’s premises. Except as noted above, SMI is not liable for any loss, injury, or damages to persons or property resulting from failure or defective operation of any merchandise furnished.

2.4 Operation and Maintenance

According to SMI, the StormScreen should be cleaned if approximately one foot of trash and debris or sediment is observed in the debris sump. The large, loose debris and trash can be removed using a pole with a grapple or net on the end. Water and accumulated sediment can be removed with mobile vactor (vacuum) equipment. The cartridges should be checked for abnormalities on the cartridge screen at this time. SMI recommends regular inspections of the system to ensure that the system is operating properly.

The drainage structures and systems upstream of the treatment system should also be maintained to ensure they are functioning properly. An Operation and Maintenance (O&M) Guideline is available from SMI and is presented in Appendix A. The O&M Guideline also provides a written procedure for cleaning the system on an annual basis, however, the vendor has recently changed this recommendation to cleaning on a quarterly basis.

2.5 Technology Application and Limitations

The StormScreen is flexible in terms of the flow it can treat. By varying the holding tank size and number of cartridges, the treatment capacity can be modified to accommodate runoff from various size watersheds. The StormScreen can be used to treat stormwater runoff in a wide variety of sites throughout the United States. For jurisdictional authorities, the system offers high levels of solids and debris removal and improved water quality. The StormScreen may be used for development, roadways, and specialized applications. Typical development applications include parking lots, commercial and industrial sites, and high-density and single-family housing. Typical development applications also include maintenance, transportation, and port facilities.

All screening systems are effective as a gross pollutant trap. Gross pollutant traps are utilized to capture litter, trash, debris, coarse sediments, and some oils. These gross pollutants, typically removed by physical separation, are transported by conveyance systems as bed load, suspended load, or floatables. Screening systems are not recommended for the removal of fine sediments, although finer particles attached to larger particles will be found and thus removed. Screening systems do not contain a soluble pollutant removal mechanism (such as cation exchange), and thus are not recommended for the removal of soluble metals. Additionally, absorbent inserts should be considered for the capture of petroleum hydrocarbons that are entrained.

2.6 Performance Claim

SMI claims that the StormScreen will function at design flow when up to 85 percent occluded, and will remove all particles greater than 2.4 mm in diameter. The StormScreen performance for pollutant removal is dependent on site conditions, sediment loading, particle size distribution, and environmental variables.

Chapter 3 Test Site Description

3.1 Location and Land Use

The StormScreen was located on the western side of Fifth Street at 33° 14' 51.5400" latitude/ 84° 15' 38.2680" longitude. The system was installed on property located within the public right-of-way.

Figure 3-1 identifies the drainage basin area, the location of the system, and the contours of the area. The drainage area for the StormScreen consists of approximately 7.3 acres, approximately 330 feet of storm drain lines, and five storm inlets. No detention areas are located within the drainage basin, and there are no open ditches upstream of the installation location. The majority of the drainage basin area consists of paved roadways, parking areas, and buildings. Retail businesses, school facilities, a bank, and an automotive service station are located in the drainage area. Small portions of the drainage area are landscaped or lawn. Taylor Street has moderate to heavy traffic volume and Fifth Street has moderate traffic volume. Aside from service station material, no major storage or use of hazardous materials or chemicals exist in the area. Figure 3-2 is an as-built drawing of the StormScreen and ancillary equipment.

The main contaminant sources within the drainage area are created by vehicular traffic, typical urban commercial land use, and atmospheric deposition. Trash and debris accumulate on the surface and enter the stormwater conveyance system through large openings in the street inlets, sized to accommodate the large storm flows that can occur in this part of Georgia.

No planned or ongoing maintenance activities (street sweeping or catch basin cleaning) are routinely completed for the installation location. City personnel stated that maintenance activities are typically performed only in emergencies. No street cleaning or other conveyance system maintenance was performed during the verification test period. There are no other stormwater best management practices (BMPs) within the drainage area.

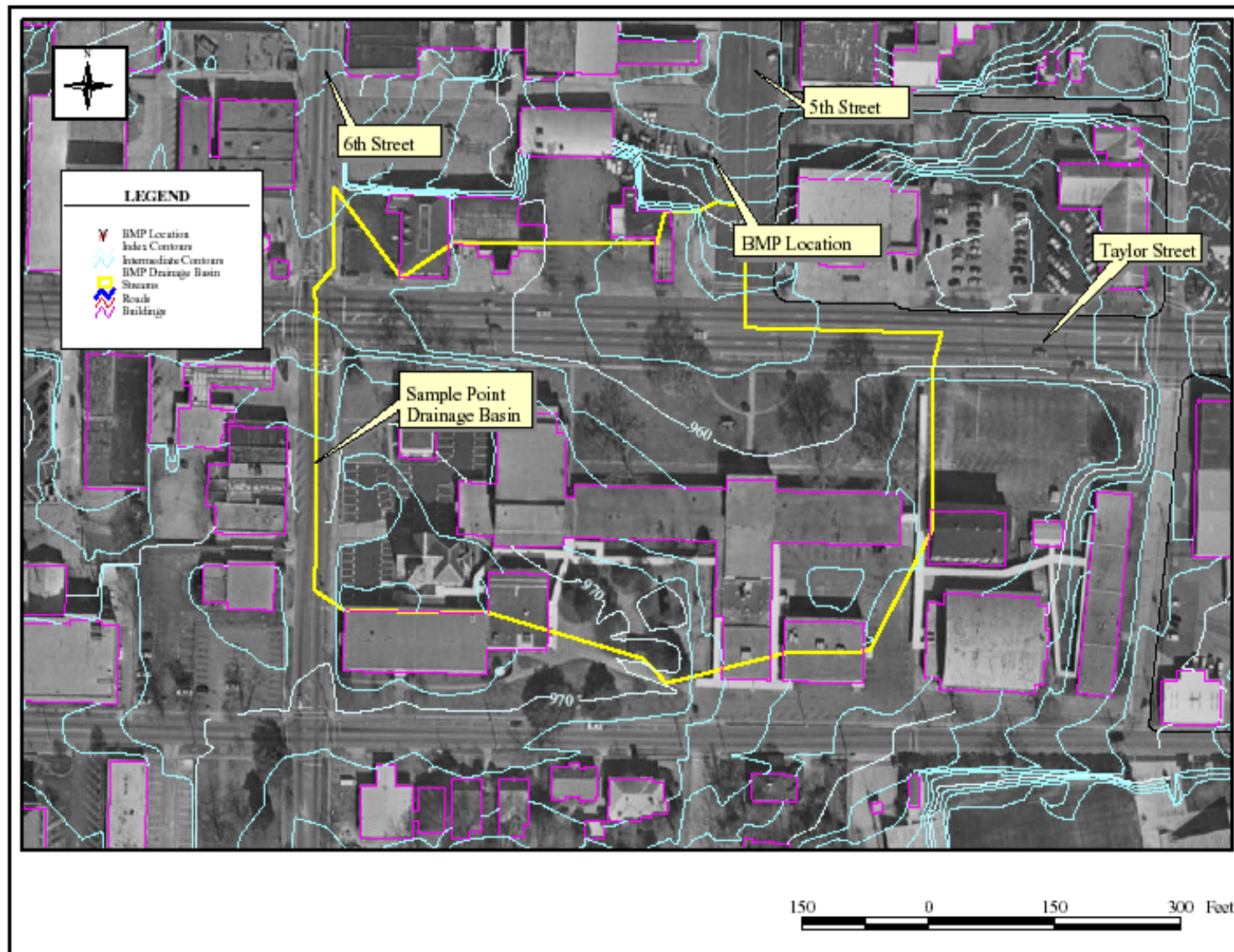

Figure 3-1. Drainage basin map with contours for StormScreen.

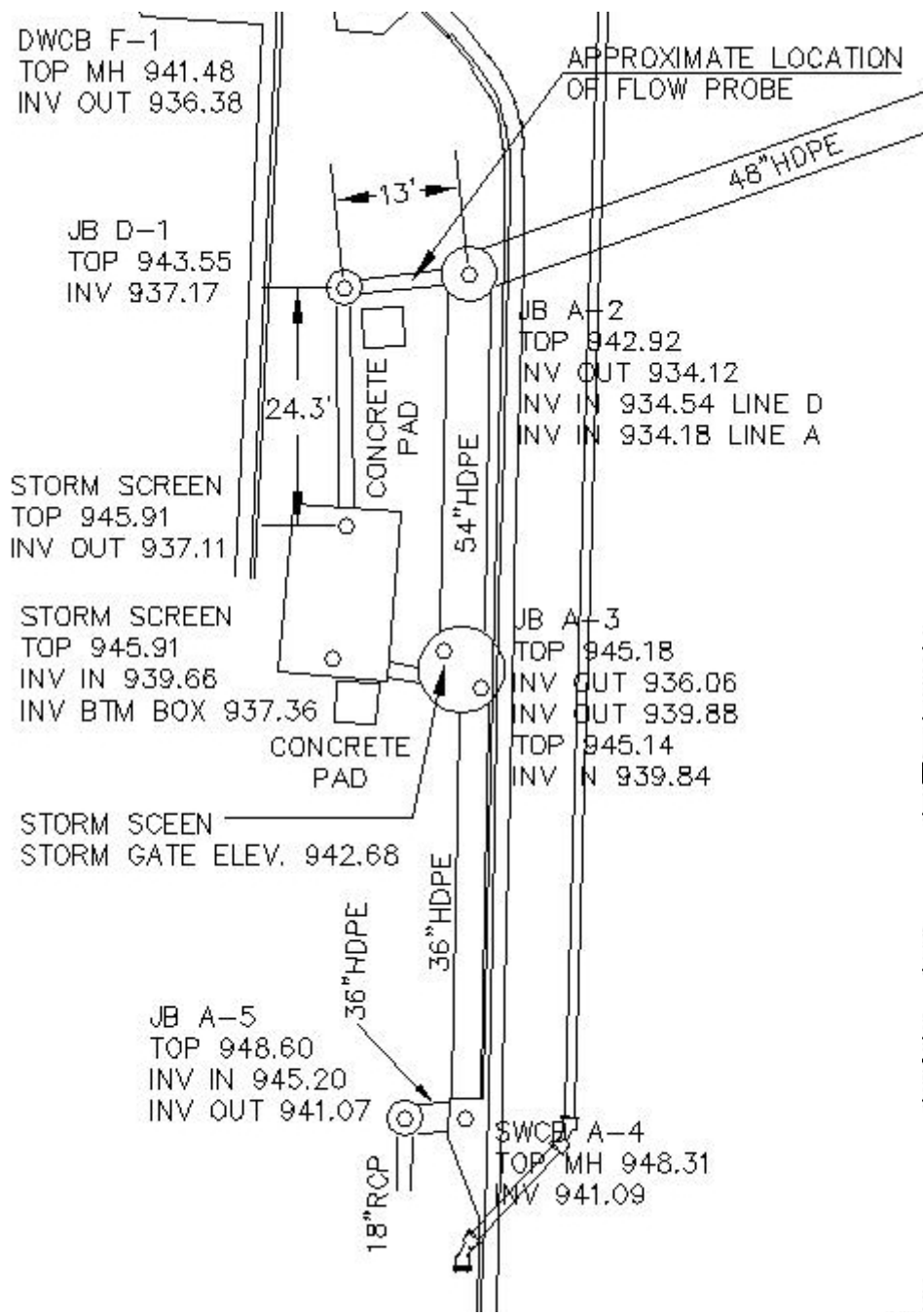

Figure 3-2. As-built drawing of StormScreen and storm drain system.

3.2 Stormwater Conveyance System and Receiving Water

The entire drainage area is served by an underground storm sewer collection system. The water is collected from the surface through standard inlet structures and is conveyed via 36- and 48-inch pipes in an easterly direction. The 36-inch pipe is connected to the StormGate. None of the stormwater runoff from the drainage basin area is treated prior to the StormScreen. Downstream from the StormScreen outlet and the bypass from the StormGate the pipe size increases to 48 inches. The combined flow, plus new incoming stormwater, then flows approximately 800 feet and enters a detention pond. The water then exits the pond to a storm pipe, where it ultimately flows into Grape Creek, approximately two-thirds of a mile from the StormScreen site.

3.3 Rainfall and Peak Flow Calculations

The rainfall amounts for the one-, two-, ten-, and twenty-five-year storms for the drainage area are presented in Table 3-1. Table 3-2 presents the intensities, in inches per hour, calculated for the given rainfall amounts. These data were utilized to generate the peak flowrates shown in Table 3-3. Table 3-4 presents the peak flow calculated using the time of concentration for the drainage basin. The City of Griffin requires that all storm drain systems be designed to accommodate the 25-year storm. A 5.42-minute time of concentration was determined for the basin, generating a peak runoff of 46.80 cfs for the 25-year storm event. The rational method was used to calculate the peak flows for the system.

Table 3-1. Rainfall Amount (in.)

Duration	1-year	2-year	10-year	25-year
30 minutes	0.99	1.19	1.58	1.81
1 hour	1.36	1.61	2.10	2.40
2 hours	1.68	2.00	2.62	2.98
12 hours	2.67	3.12	3.96	4.44
24 hours	2.87	3.36	4.32	4.80

Source: National Oceanographic and Atmospheric Administration, 2000

Table 3-2. Rainfall Intensities (in/hr)

Duration	1-year	2-year	10-year	25-year
30 minutes	1.98	2.38	3.16	3.61
1 hour	1.36	1.61	2.10	2.40
2 hours	0.84	1.00	1.31	1.49
12 hours	0.22	0.26	0.33	0.37
24 hours	0.12	0.14	0.18	0.20

Table 3-3. Calculated Peak Flowrates (cfs)

Duration	1-year	2-year	10-year	25-year
30 minutes	12.19	14.59	19.37	22.12
1 hour	8.33	9.87	12.87	14.71
2 hours	5.16	6.13	8.03	9.13
12 hours	1.36	1.59	2.02	2.27
24 hours	0.73	0.86	1.10	1.23

Table 3-4. Calculated Peak Flowrates (cfs) Using Time of Concentration

Duration	1-year	2-year	10-year	25-year
5.42 minutes	25.56	30.26	40.47	46.80

3.4 StormGate and StormScreen Installation

The StormGate and StormScreen were installed in May 2002. The StormGate was connected directly to the existing 36-inch storm sewer pipe under the roadway. The StormScreen was installed next to the roadway in the right-of-way. An 18-inch pipe was used to connect the two systems. The StormGate low-flow outlet pipe was placed at a slope of 0.07 ft/ft, and sized to more than handle the 10-cfs maximum design flow of the StormScreen. The overflow (bypass) from the StormGate was a 54-inch pipe that connected to a downstream manhole where treated water from the StormScreen was combined with any bypass water. The flow-control weir height was set by SMI after installation was complete. The discharge from the StormScreen (treated water) entered an 18-inch pipe that reconnected with the existing stormwater sewer system at a newly installed manhole. An as-built drawing showing all inlet and outlet elevations is presented in Appendix A. Based on the system elevations and the weir elevation, bypass would occur when water level reached approximately 32 inches of depth at the exit point of the 36-inch inlet pipe to the StormGate. Based on the diameter and slope of the two StormGate outlet pipes (low flow to treatment [18-inch], high flow to bypass [54-inch]) and the StormScreen outlet pipe (18-inch), all installed pipes were oversized compared to the anticipated design treatment capacity (10 cfs) of the 20-cartridge StormScreen.

Chapter 4

Sampling Procedures and Analytical Methods

4.1 Introduction

Performance of a stormwater treatment technology is characterized by how effective it is in removing targeted stormwater runoff constituents, pollutants, and contaminants. Most of the ETV testing programs under the WQPC include the collection of water samples from the inlet and outlet of treatment technologies and the analysis for chemical constituents. These data are then used to evaluate the performance of the technology by comparing the concentrations of various constituents before and after treatment. Further, the wet-weather protocols usually include summing the loads over fifteen or more events and evaluating the overall reduction in pollutant loads for all sampling events. The selection of constituents, such as suspended solids, metals, nutrients, and petroleum hydrocarbons, is based on the specific performance claims made by the vendor.

In the case of the StormScreen, the primary claim is the removal of trash, debris, and particles greater than 2.4 mm in diameter. The ETV Technology Panel discussed various methods to quantify trash and debris removal, but after many hours of discussion concluded that there are currently no acceptable standard methods for quantitatively measuring trash, debris, and very large particle removal performance. Therefore, the ETV protocol for stormwater treatment technologies does not include any specific quantitative measurements for technologies claiming trash and debris removal. The only approach for verification of this type of technology is to use visual observations by the testing organization, documented with photographs and field observations logs. This information along with basic flow data is the basis for evaluating technologies claiming trash and debris removal.

Given the history of the protocol development and input from the ETV Technology Panel, the verification test for the StormScreen consisted of observing and documenting that trash and debris are removed from the influent to the StormScreen. The observations were designed to determine if trash, debris, and large particles are captured in the system, and to verify that the system continues to operate properly after several storms have occurred, and trash, debris, and large solids have accumulated within the vault. At the end of the verification test, as described herein, the StormScreen was cleaned and the weight of the accumulated residuals was measured. This quantitative data was collected to provide an estimate of the amounts of materials that were collected using this type of system in this application.

The verification test plan presents the details on the approach used to verify the StormScreen. This plan, *Environmental Technology Verification Test Plan For Stormwater Management, Inc., StormScreen, TEA-21 Project Area, City of Griffin, Spalding County, Georgia*, NSF, June 2003, is presented in Appendix B along with all attachments. An overview of the key procedures used for this verification is presented below.

4.2 Sampling Events and Qualification Criteria

Fifteen qualified sampling events were observed and documented for this verification test. An event is deemed qualified when it meets the following criteria:

- The total rainfall depth for the event, measured at the site, is 0.2 inches (5 mm) or greater;
- Flow is successfully measured and recorded over the duration of the runoff period;
- Visual observations are noted in the fore bay, cartridge chamber, and effluent chamber; and
- There must be a minimum of six hours between qualified sampling events; that is, there will be a minimum of six hours between the termination of measured effluent flow during one event and the start of measured influent to the stormwater technology during the subsequent rainfall event.

4.3 Constituent Selection

SMI requested that the system be evaluated based on the removal of trash, debris, and large particles greater than 2.4 mm in diameter. Therefore, as discussed in Section 4.1, no influent and effluent stormwater samples were collected or analyzed. All results were based on visual observation of the system. At the end of the verification test, the residuals that accumulated in the system were collected and tested for percent moisture and leachable heavy metals.

4.4 Visual Observations

Visual observations were conducted at the fore bay, cartridge bay, and effluent bay of the StormScreen. Photographs were taken of the fore bay area and cartridge chamber and of the effluent chamber to evaluate the removal capabilities of the system. A StormScreen observation form was completed for each qualified rain event. The TO field personnel did not physically enter the vault after rain events, so all measurements shown on the observation form are estimated measurements made from the surface.

4.5 Flow Measurement

Total flow measurements were taken in the main 36-inch storm sewer upstream of the StormGate using an American Sigma 950 flowmeter. Flow measurements were also taken downstream of the StormScreen utilizing another American Sigma 950 flowmeter. This effluent flow monitoring location was prior to the manhole where the bypass flow and treated effluent water combine. Both flowmeters were equipped with an American Sigma Submerged Level/Velocity Sensor. Flows were measured at five-minute intervals over the duration of an event. The flow monitoring equipment was installed, maintained, and calibrated according to the manufacturer's specifications. Attachment F of the test plan includes this information. PCG personnel were responsible for inspection and maintenance of the flowmeter equipment.

4.6 Precipitation Measurement

4.6.1 Methods

An automatic, electronic recording rain gauge was used to record rainfall depths at intervals of five minutes. The gauge, which utilized a tipping bucket for rainfall measurement, was connected to the automated sampler, which recorded rainfall depths in increments of 0.01 inch. This data was recorded in real time.

4.6.2 Field Procedures

The rain gauge was located within ten feet of the StormScreen. The gauge was calibrated in accordance with the manufacturer's instructions, and was inspected and cleared of any debris between events. The rainfall data was downloaded with a data transfer unit (DTU II) and transferred to a digital file for project use.

4.7 Operation and Maintenance Parameters

PCG maintained a record of activities associated with operating and maintaining the StormScreen during the testing period. A visual inspection of the system was made following each storm event. PCG technicians completed an inspection log, and noted any changes that appeared to occur in the operation of the system. In accordance with the recommended inspection schedule in the StormScreen O&M Guidelines (Appendix A), PCG inspected the StormScreen at least once every two to three months. No maintenance of the system was performed during the verification test. Sediment and trash did accumulate in the system, but did not exceed the one-foot depth that would trigger a cleanout, as specified in the O&M Guidelines.

At the end of the verification test, the trash, debris, and sediment were removed using shovels and buckets. This material was allowed to drain of freestanding water, and then an estimate of the volume of recovered material was made. The material was weighed to provide an estimate of the total weight of accumulated trash, debris, and sediment. A detailed Standard Operating Procedure (SOP), included in Appendix C, was prepared for this task.

A sample of the sediment collected from the bottom of the vault was obtained and sent to the laboratory for analysis. The analyses included percent solids and Toxicity Characteristic Leachate Procedure (TCLP) metals. Table 4-1 shows the parameter list and the QA/QC objectives.

Table 4-1. Testing Method, Detection Limit, and Holding Time for TCLP and Metals

Parameter	Method	Laboratory Reporting Limit (mg/L)	Bottle Type	Maximum Holding Time
TCLP	1311	NA	Glass/polyethylene	6 months
Metals on Leachate from TCLP:				
Arsenic	6010 B	0.2	Polyethylene	6 months
Barium	6010 B	0.5	Polyethylene	6 months
Cadmium	6010 B	0.01	Polyethylene	6 months
Chromium	6010 B	0.1	Polyethylene	6 months
Lead	6010 B	0.1	Polyethylene	6 months
Mercury	7470 A	0.002	Polyethylene	6 months
Selenium	6010 B	0.2	Polyethylene	6 months
Silver	6010B	0.1	Polyethylene	6 months

Note: Sediment/solids are leached in the TCLP test. Metals are run on the leachate generated from the TCLP. All methods referenced are EPA methods from SW-846, third revision. Laboratory accuracy target for all metals is 75–125 percent. Laboratory precision target for all metals is 25 percent.

Chapter 5 Monitoring Results and Discussion

The StormScreen is designed to remove trash, debris, and some large particulates from wet-weather flows. The test plan requires that photographs and visual observations be collected, rainfall amounts and flowrates monitored, and solids accumulation at the end of the verification test evaluated as part of the verification test. The results from these observations and measurements are presented in this section.

5.1 Monitoring Results—Flow and Rainfall Data

A recording rain gauge was located at the upstream monitoring location to record rainfall over the duration of storm events in five-minute increments. The fifteen events used for this verification test covered a wide range of storms, with total rainfall amounts varying from 0.22 inches to 3.06 inches. The storms also varied in intensity from 0.12 inches per hour (0.01 inches per five minutes) to 21.6 inches per hour (0.36 inches in five minutes). Some storms were short and intense, while others were of longer duration and lower intensity. Table 5-1 shows the rainfall amounts, duration, and volume of runoff measured for each of the fifteen events.

Table 5-1. Rainfall Summary for Monitored Events

Event Number	Start Date	Start Time	End Date	End Time	Rainfall Amount (in.)	Rainfall Duration (hr:min)	Runoff Volume (ft ³) ¹
1	05/21/03	16:35	05/22/03	05:00	2.16	12:25	29,000
2	06/03/03	05:50	06/03/03	09:30	0.40	03:40	3,610
3	07/03/03	17:10	07/03/03	17:25	0.45	00:15	4,210
4	08/12/03	17:10	08/12/03	17:20	0.22	00:10	2,020
5	09/04/03	13:50	09/04/03	15:20	0.22	01:30	2,170
6	09/22/03	14:45	09/22/03	21:00	3.06	06:15	30,800
7	10/07/03	23:30	10/08/03	05:40	0.53	06:10	4,660
8	10/26/03	10:10	10/26/03	19:40	0.28	09:30	2,750
9	11/05/03	15:45	11/05/03	17:40	0.74	01:55	6,350
10	11/19/03	01:25	11/19/03	04:45	1.52	03:20	15,600
11	11/27/03	15:55	11/27/03	22:25	0.74	06:30	9,520
12	12/10/03	02:20	12/10/03	06:25	0.54	04:05	6,200
13	12/14/03	00:20	12/14/03	02:40	0.34	02:20	4,230
14	01/05/04	13:10	01/05/04	18:45	0.47	05:35	4,970
15	01/17/04	20:35	01/18/04	01:20	0.44	04:45	4,290

¹ Runoff volume measured at the inlet monitoring point.

Flowrates were recorded in five-minute increments at the upstream station, the inlet to the StormGate, to monitor the flowrate and total runoff volume entering the storm sewer conveyance

system. A second monitoring station was located in the outlet line from the StormScreen to measure the flowrates and total volume of water treated. Table 5-2 shows the results of the flow monitoring for each event. Event hydrographs have been prepared for each event and are presented in Appendix D. Representative hydrographs from several selected events are shown in Figures 5-1, 5-2, and 5-3.

Table 5-2. Runoff and Treated Water Volume Summary

Date	Rainfall (in.)	Peak Flow Rate (gpm)		Calculated Bypass (gal)	Percent Bypassed	Runoff Coefficient at Inlet ¹
		Inlet	Outlet			
05/21/03	2.16	3,780	320	45,000	20	0.37
06/03/03	0.40	2,580	380	0	0	0.25
07/03/03	0.45	1,630	160	19,700	62	0.26
08/12/03	0.22	1,590	360	2,300	15	0.25
09/04/03	0.22	630	520	0 ²	0 ²	0.27
09/22/03	3.06	3,730	410	161,000	69	0.28
10/07/03	0.53	1,450	340	8,500	24	0.24
10/26/03	0.28	890	350	0 ²	0 ²	0.27
11/05/03	0.74	2,430	340	32,800	69	0.24
11/19/03	1.52	5,250	590	87,100	74	0.28
11/27/03	0.74	550	540	0 ²	0 ²	0.35
12/10/03	0.54	430	300	0 ²	0 ²	0.32
12/14/03	0.34	1,160	140	20,200	63	0.34
01/05/04	0.47	1,210	250	25,600	69	0.29
01/17/04	0.44	630	320	0 ²	0 ²	0.27

¹ Total volume of runoff at the inlet divided by the total volume of water on the falling the drainage area.

² Some water may have bypassed. However, the elevation/level data at the inlet indicate bypass did not occur, as level did not exceed the weir height. The volume difference is most likely due either to possible outlet meter negative bias or inlet meter positive bias during surcharge conditions.

Monitoring the flowrates and volumes at the inlet to the StormGate and the outlet of the StormScreen provides information to estimate the amount of water that bypassed the treatment system. Table 5-2 shows the estimated bypass flow for each event, based on the volumes recorded at the inlet and outlet flowmeters. The outlet volumes have been corrected to account for the initial filling of the vault. This is necessary since after a storm event ends the vault slowly releases water until all has been drained from the system. This volume of water is discharged at a slow flowrate that is not accounted for by the downstream flowmeter.

The data shows that for at least nine of the monitored events, bypass occurred at runoff flowrates less than the anticipated design capacity of the StormScreen. These results indicate that the treatment system, as configured, was not routinely capable of handling the design peak flowrates of 10 cfs (4,488 gpm). The typical peak flowrates measured at the outlet of the StormScreen range from 350 to 600 gpm, as shown in Table 5-3.

Table 5-3. Event Maximum Flowrate and Maximum Level

Date	Rainfall (in.)	Peak Flowrate (gpm)		Peak Level (in.)	
		Inlet	Outlet	Inlet	Outlet
05/21/03	2.16	3,780	320	36	2.2
06/03/03	0.40	2,580	380	32	2.5
07/03/03	0.45	1,630	160	35	1.4
08/12/03	0.22	1,590	360	33	2.4
09/04/03	0.22	630	520	9.6	3.0
09/22/03	3.06	3,730	410	37	2.6
10/07/03	0.53	1,450	340	34	2.3
10/26/03	0.28	890	350	13	2.4
11/05/03	0.74	2,430	340	34	2.3
11/19/03	1.52	5,250	590	38	3.2
11/27/03	0.74	550	540	13	2.9
12/10/03	0.54	430	300	24	2.0
12/14/03	0.34	1,160	140	31	1.2
01/05/04	0.47	1,210	250	33	1.8
01/17/04	0.44	630	320	24	2.1

StormScreen Upstream 999 Event: 5/22/03

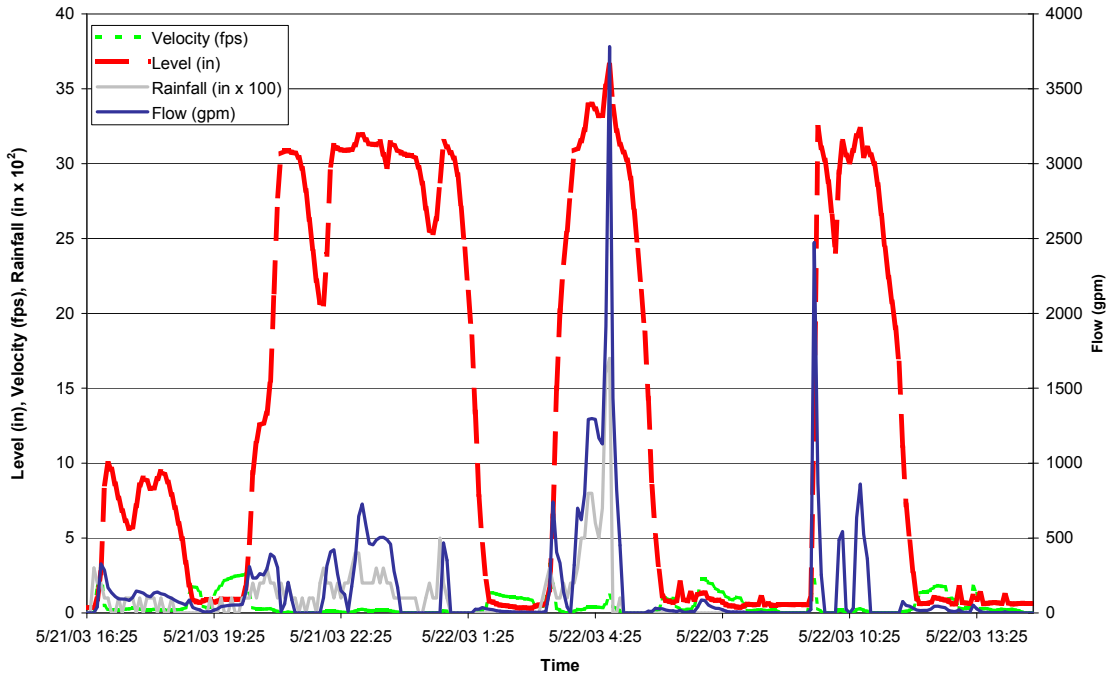

StormScreen Downstream May 22, 2003

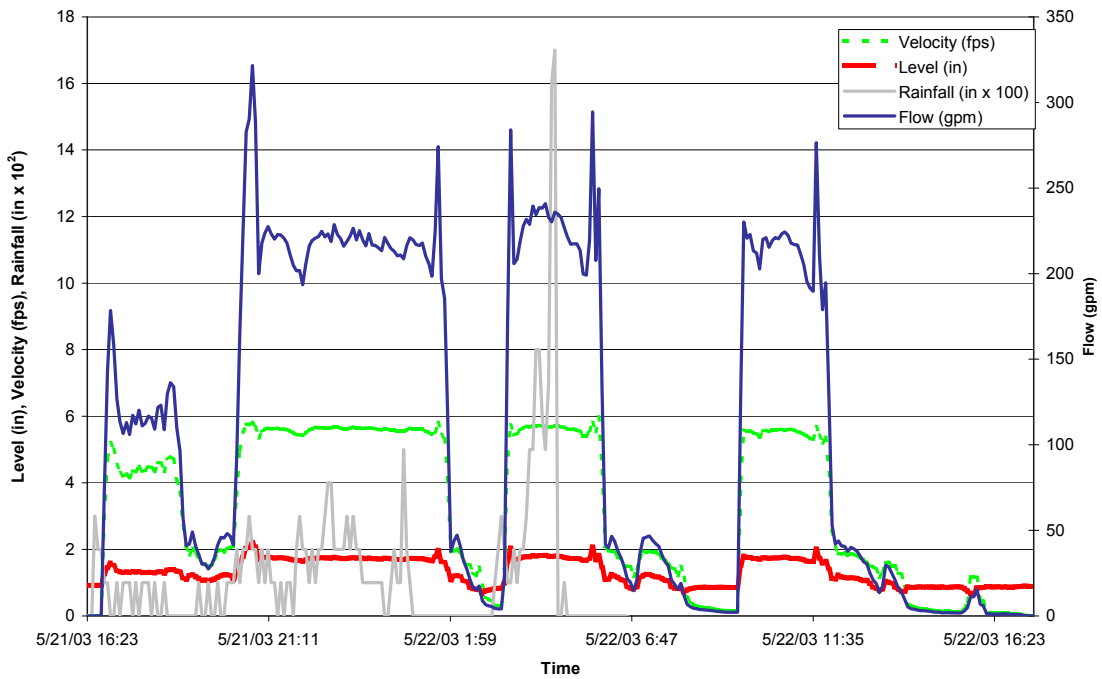
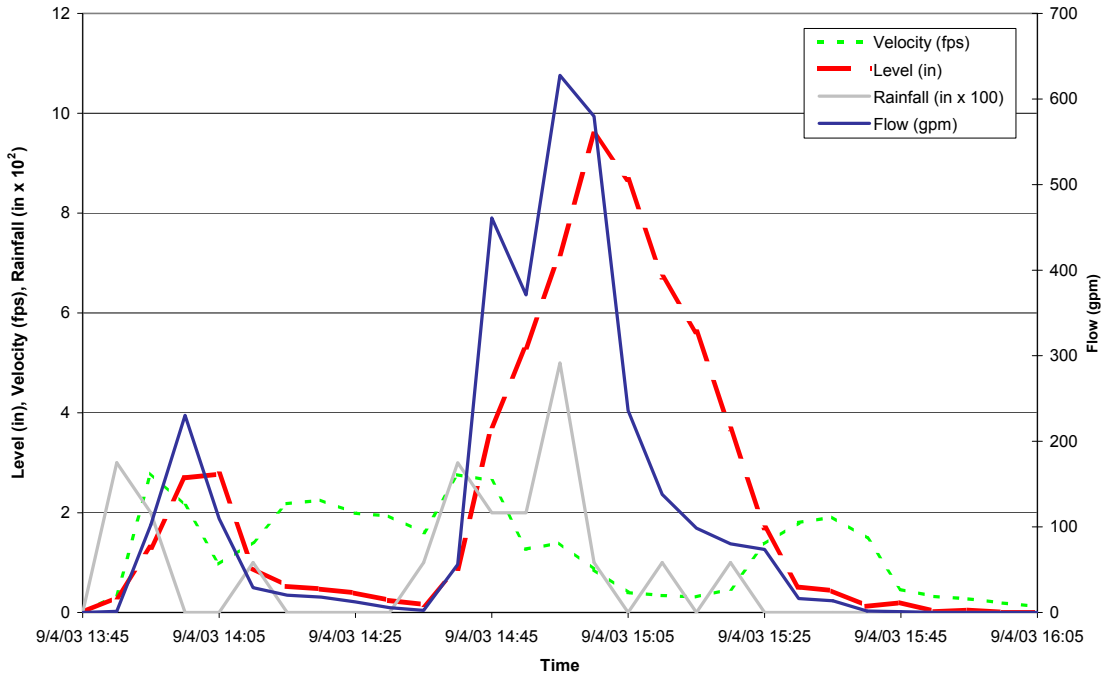

Figure 5-1. Inlet and StormScreen outlet hydrographs, May 21-22, 2003.

StormScreen Upstream September 4, 2003



StormScreen Downstream September 4, 2003

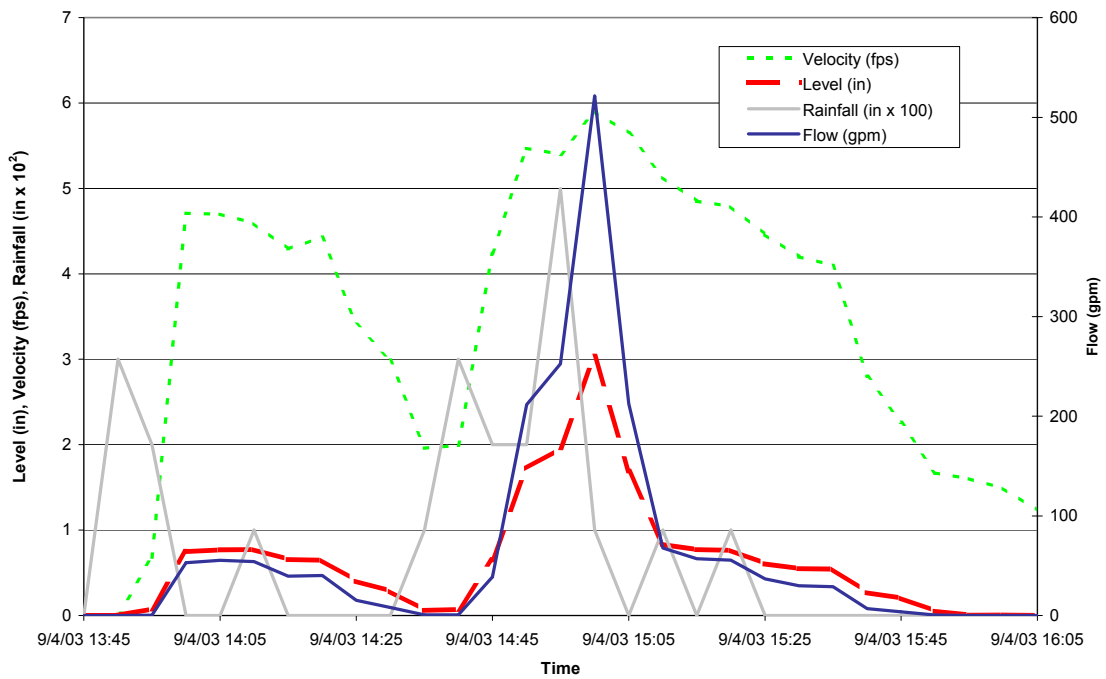
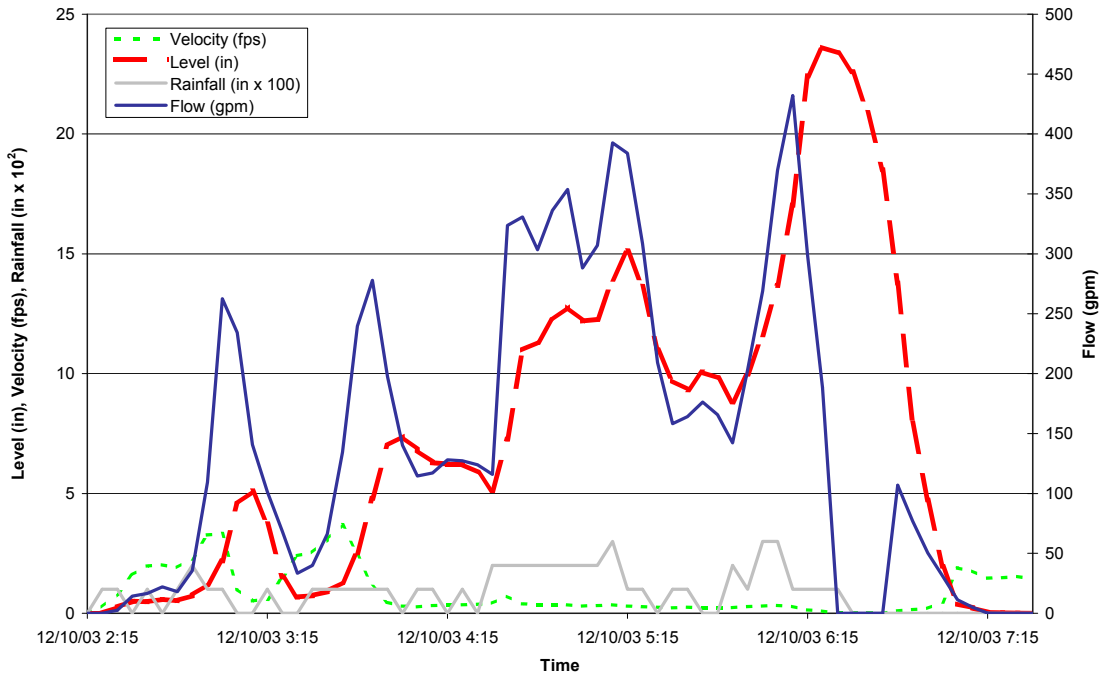

Figure 5-2. Inlet and StormScreen outlet hydrographs, September 4, 2003.

StormScreen Upstream December 10, 2003



StormScreen Downstream December 10, 2003

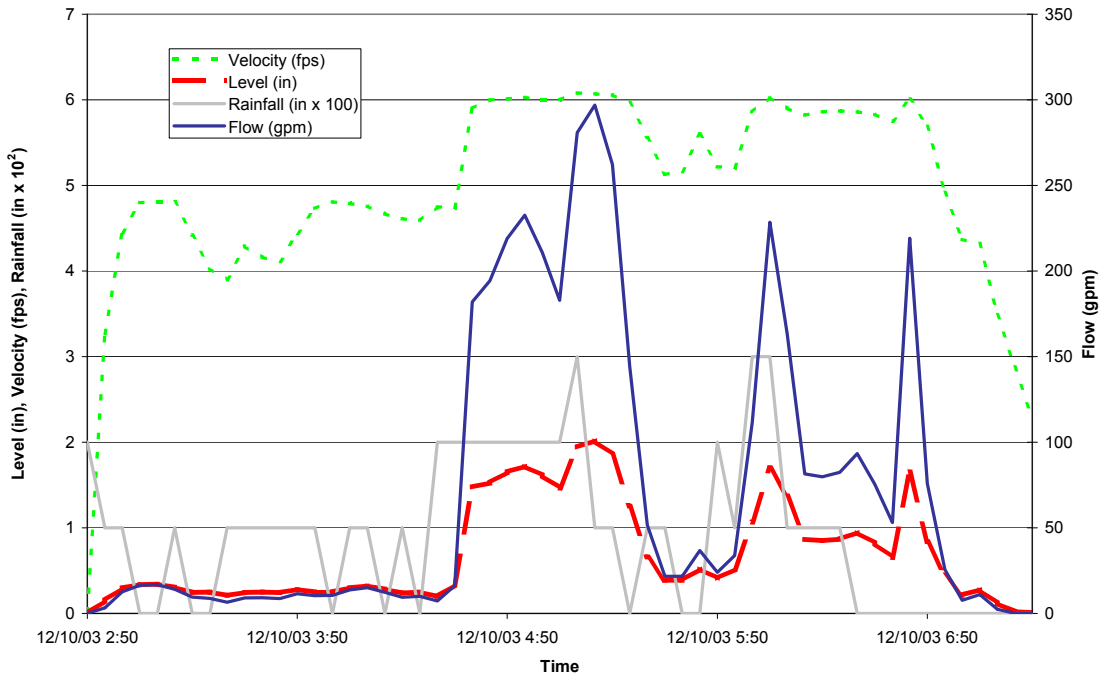

Figure 5-3. Inlet and StormScreen outlet hydrographs, December 10, 2003.

According to the specifications, the StormGate weir was set to divert all of the flow up to 10 cfs (4,488 gpm) to the StormScreen for treatment and bypass any higher flowrates over the weir to the bypass pipe. As flowrates began to exceed the maximum flow that could be treated in the StormScreen, water would begin to back up in the StormGate and the water level would rise. When the water level reached the top of the weir, excess water bypassed the StormScreen and entered the downstream storm sewer.

For this installation, the rising water level in the StormGate also caused the water level in the inlet pipe to rise at the location where the inlet level and velocity monitor was located. Thus, the water level in the inlet storm sewer pipe provided an indication of the water level in the StormGate and whether bypass water could flow over the weir. When the water level in the inlet pipe reached approximately 32 inches (2.67 ft), water would overflow the weir and bypass the system. Table 5-3 shows the peak flowrates for the inlet and outlet locations, and the peak level of water in the inlet and outlet pipes. The data shows that water levels exceeded 30 inches at the inlet station for ten storm events, with nine of the events showing evidence that some amount of bypass occurred. The five other events had water levels in the inlet pipe in the 9.6- to 24-inch range. For these five events, it does not appear that bypass occurred, given the fixed weir height and visual confirmation that the weir was intact, solid, and not leaking water. For three events, the flow balance was within 20 percent, which is within typical measurement error between flowmeters in this type of nonideal flow monitoring locations. For the two events that showed a large difference between the inlet and outlet total volume (11/27/03 and 12/10/03), it appears that a combination of the surcharged condition at the inlet monitoring locations (yielding possible positive bias at lower flows) and the high-velocity outlet location (yielding possible negative bias at low water levels, but high velocity) is the most likely source of the total volume difference. The peak flowrate from the StormScreen was similar to other events and the system should have been able to handle the flowrates for these events, even with the apparent reduced capacity from the original design capacity.

The flow data from the StormScreen outlet shows that the system was typically treating between 150 to 250 gallons per minute when the system was flowing at a steady rate. Each event had a peak discharge rate (typically 300 to 600 gpm) that was higher than the base rate. These peak rates were preceded or followed by periods of time (5 to 30 minutes) when the system was running at a fairly steady rate as it processed the water that had entered and accumulated in the cartridge bay, fore bay, and StormGate. The StormScreen did appear to process somewhat more water when the levels in the StormGate were higher, indicating more water was entering the StormScreen, possibly due to there being more head on the system.

The reason the cartridges were not capable of processing the design flowrate is not known. There would appear to be two possible explanations: either the cartridge design does not allow the screens to achieve full design discharge flowrate or rapid occlusion of the cartridges (possibly due to a heavy load of clay or organic material). The system was cleaned in February 2003 and the test started in May 2003. If occlusion was a contributing cause, it would have occurred between February and May. The peak flowrates during the verification test did not indicate additional deterioration of peak discharge rate as trash, debris, and other material accumulated in the cartridge bay.

There is no evidence that the reduced capacity of the cartridges was caused by hydraulic conditions upstream or downstream of the StormScreen. On the inlet side of the system, there was no apparent restriction in the 18-inch inlet pipe. Based on visual observations after each event, water elevations in the cartridge bay reached 60 to 75 inches, which is at least one foot above the top of the inlet pipe where it enters the StormScreen. The 18-inch discharge pipe did not have any apparent flow restriction that might cause water to back up into the vault. The maximum water elevation observed at the discharge pipe was five inches, indicating that water did not surcharge in the discharge pipe and back up into the outlet bay.

5.1.1 Flow Verification

The flow capacity data was reviewed with SMI, and they hypothesized that the reduction in the flow capacity through the system was the result of the cartridge screens becoming occluded. To test this theory, SMI sent a two-person crew, supervised by PCG and NSF personnel, to the site on December 2, 2004, to conduct additional testing.

The StormScreen is designed so that the cartridges discharge screened water into one of four flumes, which drains into the outlet bay. One series of cartridges that discharge to the same flume was thoroughly cleaned by removing the hoods and hand-scraping sediments from the screens. The vendor noted that the screens were occluded with a mat of organic detritus and clay. The cartridges were reassembled after cleaning. The vendor installed an area-velocity flow probe (ISCO 4150 flow logger with low profile) in the effluent pipe, and calibrated the depth probe prior to testing.

With permission from the city, PCG personnel attached a fire hose to a nearby hydrant, which was used to fill the StormScreen vault with water. The manhole covers were removed to observe the water in the vault. As the water elevation in the vault crested the discharge flumes, a baseline trickle flow passed through all four flumes. The area-velocity flow probe recorded this flow at 0.31 cfs (140 gpm), which was consistent with the background flowrate noted during most of the verified storm events.

The City of Griffin instructed PCG to shut off hydrant flow with between two and three inches left to reach design water elevation in the vault. As the water level in the vault dropped, the head differential within the cartridges with the cleaned screens caused the floats in the cartridges to rise, and a brief period of high flow occurred, peaking at 1.12 cfs (500 gpm) and lasting approximately 10 seconds. Unfortunately, the data storage interval of the flow monitor was set too high to register this peak in the hydrograph; however, the vendor photographed the high-flow discharge, shown in Figure 5-4. Because the driving head across the system never achieved design capacity, this test could not conclusively prove that the StormScreen could discharge at design flow. The observed peak and attached photos do, however, indicate that when the screens were cleared of debris, they were capable of discharging more water than the flows measured throughout the testing period.

This short test suggests that a clean system could discharge at least 0.8 cfs per flume or 3.2 cfs for the four-flume system used in the verification test, versus the maximum flowrate of 1.3 cfs

measured during the verification test. It would appear that the system did experience significant occlusion that reduced maximum flow capacity. However, it is also not clear that a completely clean system would achieve the maximum design capacity stated by SMI. Based on the apparent finding of rapid occlusion in the screens, SMI recommends that StormScreen applications with heavy leaf and organic loads have a frequent maintenance cycle. The maintenance cycle would be based on actual field observations.



(a) Flumes at trickle flow
(approximately 0.08 cfs each)

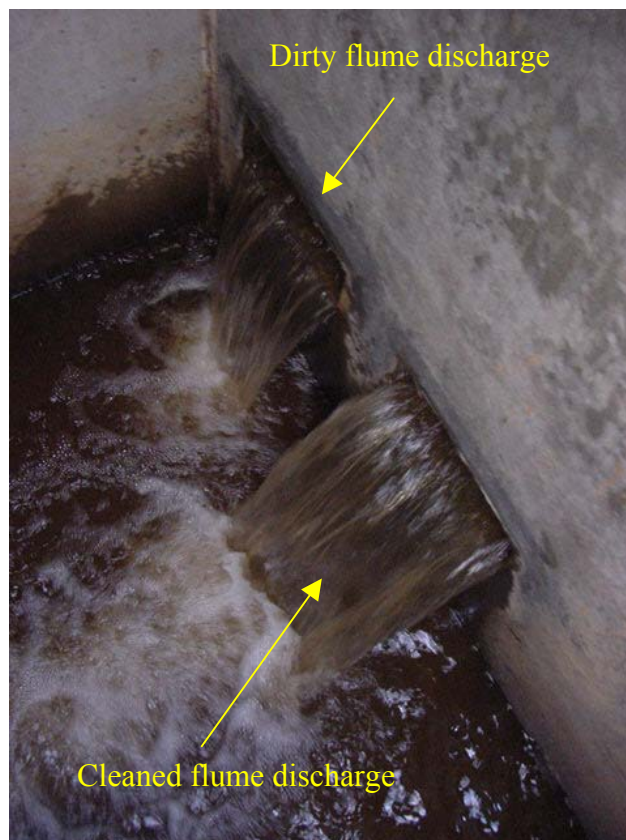

(b) Cleaned flume discharging at
approximately 0.8 cfs

Figure 5-4. Photographs from flow test.

5.2 Observations of StormScreen Performance—Trash and Debris Removal

As described in Section 4.1, there are limited options for quantitative measurement of trash and debris removal. The primary method for evaluating the performance of the StormScreen was by documenting visual observations following each event and taking photographs. The observation forms provided guidance regarding the types of material present and on the water depths that occurred in the system. Figure 5-5 shows an example of the observation form used for all events. A complete set of observation forms for all events is provided in Appendix E. Table 5-4 presents a summary of some of the key observations noted on the forms.

The StormScreen was effective in trapping and removing trash and debris that reached the system. Floating debris, leaves, and general trash (cups, paper, etc.) were clearly present in the system after each event, as shown in Figures 5-6, 5-7, and 5-8. The design of the vault and cartridges provided an effective barrier and these large materials were retained in the vault.

The StormScreen also collected large sediment particles and retained some oil and grease, based on visual observations. A sheen of oil was present in the fore bay and cartridge bay after most events, and the sediment in the fore bay and the cartridge bay slowly built up over time. As shown in Table 5-4, the estimated depth of sediment continued to increase over the nine months that observations and flow measurements were collected. More quantitative information is provided in Section 5.4 describing the cleanout performed at the end of the verification test.

In addition to the observation forms presented for all events, Appendix E includes photographs taken from each event. Field observations and photographs indicate StormScreen performed in accordance with the claim that it can remove trash, debris, and some large solids. There was no direct physical inspection performed of the screen condition under the hoods during the verification test, only visual inspection from the surface. Trash, debris, and solids were noted after all events, while the effluent bay was clear of trash and debris and only showed a slight buildup of sediment.

The accumulation of sediment and debris on the cartridges and in the sump does not appear to have resulted in a decrease in flow capacity over the course of the verification test. The data in Table 5-3 and the hydrographs show that the peak flowrates remained steady throughout the test period, so the decreased flow capacity does not appear to be related to the accumulation of solids during the verification test. The postverification test cleanout in May 2004 and the additional system flow check performed in December 2004 indicate that the cartridge screens had a significant accumulation of organic detritus and clay. The rate at which the organic detritus and clay accumulated on the screens is not known. It appears that the initial accumulation of material caused a significant loss of peak flowrate capacity, but the flow capacity decreased to a steady state where additional debris accumulation did not cause the flow to further decrease.

Table 5-4. Summary of Field Observations

Date	Debris Description Fore Bay	Debris Description Cartridge Bay	Sediment Depth in Fore Bay (in.)	Sediment Depth in Cartridge Bay (in.)	High Water Mark in Fore Bay (in.)	High Water Mark in Cartridge Bay (in.)
05/21/03	Mud, sand, leaves, misc. debris	Mud, sand, leaves, misc. debris	<0.25	<0.25	75	75
06/03/03	Mud, sand, leaves	Mud, sand, leaves	0.25	>0.25	75	75
07/03/03	Organic, misc. debris	Organic, misc. debris	<0.25	<0.25	60	60
08/12/03	Light leaves and bark	Light leaves and bark	0.5	0.5	75	75
09/04/03	Slight amount of debris	Little debris	0.5	0.5	60	60
09/22/03	Leaves, little debris	Leaves, little debris	0.5	0.5	60	60
10/07/03	Some debris, leaves and decaying organics	Some debris, leaves and decaying organics	0.5	0.5	60	60
10/26/03	Average debris, leaves and organics	Average debris, leaves and organics	>0.5	>0.5	60	60
11/05/03	Heavy debris, leaves and organics	Heavy debris, leaves and organics	>0.5	>0.5	75	75
11/19/03	Heavy debris, leaves and organics	Heavy debris, leaves and organics	>0.5	>0.5	75	75
11/27/03	Average debris, leaves and organics	Average debris, leaves and organics	>0.5	>0.5	75	75
12/10/03	Average debris, leaves and organics	Average debris, leaves and organics	10	>0.75	75	75
12/14/03	Average debris, leaves and organics	Average debris, leaves and organics	10	>0.75	75	75
01/05/04	Average debris, leaves and organics	Average debris, leaves and organics	5	0.5	75	75
01/17/04	Average debris, leaves and organics	Average debris, leaves and organics	10	0.5	75	75

Note: Miscellaneous debris, such as soda cans, cigarette butts, plastic cups, were present in all observations of the fore bay and cartridge bay.

StormScreen Observation Form				
Site: StormScreen	Location: 3rd St.	Date and Time: 7/3/03	Total Rainfall Depth (in.): 0.45	Average Duration of Storm (hr:mm): 2:40 (inlet and outlet)
Total System Estimated Average Influent (gal): 31,475		Estimated Average Bypass (gal): 24,280		Estimated Average Treated (gal): 7,195
Fore Bay Notes / Measurements		Cartridge Bay Notes / Measurements		Outlet Bay Notes / Measurements
Oil sheen presence and degree of: Slight oil sheen		Oil sheen presence and degree of: Slight		Oil sheen presence and degree of: None
Debris presence and description of: Organic (0.25" on wall & steps)		Debris presence and description of: Organic (0.25" on filters)		Debris presence and description of: None
Structural condition (leaks, cracks, etc.): Good		Structural condition (leaks, cracks, etc.): Good		Structural condition (leaks, cracks, etc.): Good
Current water depth (in.): 20 in.		Current water depth (in.): 20 in.		Current water depth (in.): 9 in.
High water mark (in.): 60 in.		High water mark (in.): 60 in.		High water mark (in.): 33 in.
Sediment depth (in.): <0.25 in.		Sediment deposition degree on cartridge hoods: < 0.25 in.		Sediment depth (in.): < 0.25 in.
Additional notes:		Additional notes:		Additional notes:

Figure 5-5. Example StormScreen field observation form.



(a) StormScreen vault, June 4, 2003



(b) StormScreen outlet bay, June 4, 2003



(c) StormScreen vault, August 12, 2003



(d) StormScreen vault, May 22, 2003

Figure 5-6. StormScreen photographs, May through August 2003.



(a) StormScreen inlet, September 4, 2003



(b) StormScreen vault, September 4, 2003



(c) StormScreen vault, August 12, 2003



(d) StormScreen vault, September 24, 2003

Figure 5-7. StormScreen photographs, August through September 2003.



(a) StormScreen outlet bay, September 24, 2003



(b) StormScreen vault, September 24, 2003



(c) StormScreen outlet bay, October 26, 2003



(d) StormScreen vault, October 8, 2003

Figure 5-8. StormScreen photographs, September through October 2003.



(a) StormScreen vault, November 5, 2003



(b) StormScreen vault, November 5, 2003



(c) StormScreen vault, November 5, 2003



(d) StormScreen vault, November 5, 2003

Figure 5-9. StormScreen photographs, November 2003.



(a) StormScreen outlet bay, January 7, 2004



(b) StormScreen vault, January 7, 2004



(c) StormScreen vault, January 17, 2004



(d) StormScreen vault, January 17, 2004

Figure 5-10. StormScreen photographs, January 2004.

5.3 Operation and Maintenance

The StormScreen was installed on May 9, 2002. It operated for one year prior to the start of the verification test and through the nine months of verification test without any apparent mechanical problems with the cartridges or any special maintenance requirements. Based on visual observation from the surface, the screens appeared to continue to function normally even when the cartridge hoods and vault contained debris and solids. No maintenance was performed during the verification test. The StormScreen and the screens in the cartridges were cleaned in February 2003 (after nine months of operation) prior to the start of the verification test, and again after the verification test in May 2004 (15 months of operation). The system design appears to be robust and capable of withstanding the environment presented by stormwater and stormwater conveyance systems. As discussed in Section 5.1, the system did not achieve the design flowrate of 10 cfs, but based on visual observations this did not appear to be caused by a buildup of trash and debris clogging the screens. Based on the post verification flow test (December 2004), it appears that screen performance was probably impacted by buildup of organic and clay materials between the February 2003 cleaning and the start of the test in May 2003.

SMI provides an Operations and Maintenance (O&M) Guideline Manual, included in Appendix A, which describes the cleanout procedures for the StormScreen. The procedures are clearly described and are similar to those used for cleaning the system at the end of the verification test. The normal cleanout should be easier and faster than the one used for the verification test, as detailed measurements of the weight of solids accumulated by the system are not normally needed for routine cleanout. A vactor truck can be used to remove the solids rather than the shovel and bucket/barrel approach described in Section 5.4.

SMI states that the StormScreen should require annual maintenance in normal service applications, but that cleaning may be needed six months after initial installation due to soil erosion on newly constructed sites. SMI also states that site-specific conditions, such as site activities (commercial, residential, and industrial locations will vary in pollutant loading) and stormwater pollutant source control practices (sweeping, covered solids storage, etc.) will impact cleaning frequency. SMI has indicated that based on the findings of this verification test, they recommend more frequent system checks and cleaning when large amounts of clay and organic detritus are present in the stormwater being treated by the system.

According to SMI's O&M Guideline, the following should be noted and recorded during inspection:

1. Visually inspect the inlet bay to make sure debris does not hinder water flow.
2. Inspect the filtration bay with a conventional dipstick to determine the depth of trash, debris, and sediment in the system. If one foot or more of either is measured, refer to the "Maintenance Methods" section.
3. Inspect for water. The filtration bay should be completely dewatered. If water has not drained down, refer to the "Maintenance Methods" section.
4. Inspect the structural integrity of the vault.

Based on over one year of observations and verification testing, these general guidelines seem reasonable for the StormScreen system in applications where large trash and debris are the primary pollutants present in the stormwater. Regular inspection is needed to ensure that the system is operating properly. However, while the cartridges and the overall system have a robust design to handle trash and debris, smaller particles, such as fine debris, clay, and organic matter trapped in the system appear to have the potential to cause clogging in the cartridges. In applications where these fine materials are present in large quantities, more frequent inspection and cleaning may be required. Quarterly or even monthly inspection and cleaning may be required in some applications. The actual type of material present in any specific location is often not known in advance. Therefore, in order to assess the actual types of materials present in a specific location and their impact on inspection and cleaning frequency requirements, it is recommended that inspection of the cartridges be performed monthly or quarterly during the first year of operation. The results of the more frequent inspections can then be used to determine the inspection and cleaning frequency required at a specific location.

It was not possible to challenge the StormScreen (after cleaning one set of screens on one flume) to maximum design flow (2.5 cfs per set or per flume) in the postverification flow test. This was because the City of Griffin ordered the water to be shut off before the vault was fully charged. This flow test did show that after cleaning, peak flowrates on the order of 1.12 cfs could be obtained from one set of screens. This peak flowrate is still well below the design rate of 2.5 cfs. Based on the findings of this verification test, it is not possible to verify that the StormScreen can, in fact, achieve the design flowrate with 85 percent occlusion of the screens. Given the uncertainty that the screens can achieve the full design flowrate, based on these test results, it is recommended that users check the design flowrate of the system after the initial installation when the screens are clean.

5.4 Trash, Debris, and Solids Removal

5.4.1 *Weight of Solids Removed*

At the end of the verification test, on May 12, 2004, a two-person SMI crew came to the site to clean the system under the observation of PCG. The work was completed in accordance with a Standard Operating Procedure (SOP) prepared by SMI (Appendix C). Griffin provided a two-person team with a vactor truck and a dump truck. The cleanout was somewhat more complicated than a normal maintenance procedure, as the goal was to collect as much of the solids as possible in order to determine the weight of solids retained in the system. As described below, it rained the day before the cleanout began, so it was necessary to dewater the system with a vactor truck before solids could be shoveled into buckets and raised to the surface.

The field report by the SMI field team on the StormScreen cleanout included the following observations and detail.

0835 AM: SMI arrived onsite and removed the manhole covers to inspect vault. Thunderstorms occurring the previous day had filled the vault, and the water level had drained down to just below the StormScreen flumes (approximately two feet). SMI

personnel awaited the arrival of Griffin and PCG personnel prior to proceeding with the cleanout.

0900 to 0930 AM: PCG arrived onsite. A City of Griffin dump truck arrived to collect and remove sediment, and a vactor truck came to remove liquid. The vactor crew removed the standing water by slowly lowering the truck's suction pipe to just below the standing water level in the cartridge bay and the fore bay. Some solids and floatables were removed during this process, but care was taken to minimize this loss.

0945 AM: A hired contractor set up forced air ventilation, and SMI tested the vault atmosphere prior to confined space entry. Initial readings showed high levels of combustibles, but it was determined that these were due to exhaust from the generator used to power the ventilation fan. The fan was repositioned away from the generator exhaust, and subsequent readings were negative.

1000 AM: Solids removal began according to the SOP, with deviations as listed:

- Due to excessive solids loading on the hoods of the StormScreen cartridges, cartridge inspection was carried out in the vault instead of at the surface as proposed in the SOP. Solids to be removed at the surface and added to the bulk solids were simply scraped to the vault floor. The cartridge screens did not appear to be occluded in excess of 85 percent, so the hoods were not removed. The hoods were agitated by knocking a shovel handle against them, causing trapped solids to fall out. Solids accumulation on the flumes and hood exteriors were scraped to the vault floor.
- 30-gallon polypropylene drums were used instead of 55-gallon drums. These were fitted with a rope and hoisted out of the vault using a forklift.
- The contents of the drum were removed and weighed in five-gallon increments using buckets.
- Solids were removed by shovel until the vault contents were reduced to 0.25 inch of slurry across the bottom of both vault bays. This was removed with the vactor truck.

As outlined in the SOP, a representative sample was collected in five-gallon buckets. One shovel of material was added to each bucket per barrel retrieved, resulting in three five-gallon buckets of sample. These buckets were mixed in an empty barrel, and split into subsamples for laboratory analyses. Three one-liter samples were taken for percent solids analysis, and one one-liter sample was analyzed for TCLP metals. Samples were sent to the analytical laboratory by PCG. An estimated 10 to 15 gallons of loose trash and debris (mostly soda cans and bottles, which did not contribute to the mass loading) were removed separately. The majority of the solids mass consisted of leaves and organic matter.

Rainfall was predicted for the afternoon of May 13, 2004, which would have created a hazardous work environment in the vault, and spoiled the solids assessment. To expedite the sediment removal and avoid damaging the polypropylene drums, the drums were removed when they were about two-thirds full. As a retrieved barrel was being weighed and emptied into the dump truck, the next barrel was lowered into the vault to be filled. This rapid-fire system allowed for a timely removal of solids, but prohibited an accurate estimate of volume. An estimated volume of 470

gallons or 63 cubic feet of wet sediment was removed during this process. The volume of solids was estimated by recording the volume of sediments in each container used to transport solids from the StormScreen to the dump truck. The volume of the weighed solids would have fit in one vactor truck if normal cleanout procedures had been used.

A total of 4,016 pounds of solids (wet weight basis) were removed during this cleanout. Samples of the solids were sent to the laboratory for percent solids analysis. The laboratory removed any excess freestanding water and performed a percent solids test on two different samples. One sample was split into three samples that were run in duplicate and the other sample was run in triplicate. The results are shown in Table 5-5. The average percent solid for the samples was 29 percent. Using this average value, it is estimated that approximately 1,160 pounds of solids (dry weight basis) was removed from the system.

Table 5-5. Percent Solids of Solids Removed from StormScreen

Sample Number	Sample Split Number	Percent Solids
Sample #1		19
Sample #1		17
Sample #1		23
Sample #1 Mean		20
Sample #2	Split #1	38
Sample #2	Split #1	36
Sample #2	Split #2	38
Sample #2	Split #2	40
Sample #2	Split #3	38
Sample #2	Split #3	39
Sample #2 Mean		38
Overall Mean		29

Sample #1 was run in triplicate; sample #2 was split into three samples and each sample run in duplicate.

5.4.2 TCLP Results

Samples of the solids removed from the vault were sent to the laboratory for TCLP metals analysis. These results shown in Table 5-6 indicate that any metals present in the solids were not leachable and the sediment was not hazardous. Therefore, it could be disposed of in a standard Subtitle D solid waste landfill or other appropriate disposal location. The solids collected in the StormScreen were taken to the local municipal landfill for disposal.

Table 5-6. TCLP Results for Cleanout Solids

Parameter	TCLP Result (mg/L)	Regulatory Hazardous Waste Limit (mg/L)
Arsenic	<2.5	5.0
Barium	0.5	100
Cadmium	<0.01	1.0
Chromium	<0.01	5.0
Lead	<0.1	5.0
Mercury	<0.005	0.2
Selenium	<0.5	1.0
Silver	<0.01	5.0

Chapter 6

QA/QC Results and Summary

QA/QC summary results are reported in this section, and the full laboratory QA/QC results and supporting documents are presented in Appendix F.

6.1 Laboratory Data QA/QC

The laboratory analyses for this verification test were TCLP analyses and metals testing on sediment samples, and percent solids analyses. ASI followed the QA procedures in the ASI QA/QC manual (Attachment I of Appendix B). The goal for the metals analyses was to achieve precision of 25 percent and accuracy of 75 to 125 percent for all metals being tested. Sediments were analyzed using EPA-approved methods as given in SW-846 or equivalent Standard Methods. Table 4-1 showed the test methods, bottle types, and reporting limits for these analyses.

6.1.1 Precision

Precision refers to the degree of mutual agreement among individual measurement and provides an estimate of random error. Analytical precision is a measurement of how far an individual measurement may deviate from a mean of replicate measurements. Precision is evaluated from analysis of field and laboratory duplicates and spiked duplicates. The standard deviation (SD), relative standard deviation (RSD), and/or relative percent difference (RPD) recorded from sample analyses are methods used to quantify precision.

Precision measurements were performed by the collection and analysis of duplicate samples. The relative percent difference (RPD) recorded from the sample analyses was calculated to evaluate precision. RPD is calculated using the following formula:

$$\%RPD = \left(\frac{|x_1 - x_2|}{\bar{x}} \right) \times 100\% \quad (6-1)$$

where:

x_1 = Concentration of compound in sample

x_2 = Concentration of compound in duplicate

\bar{x} = Mean value of x_1 and x_2

The laboratory analyzed matrix spike duplicates as part of the metals analyses. All of the data for the one dataset that apply to the test samples were within established limits. Results are shown in Table 6-1.

Table 6-1. Analytical Precision Summary

Parameter	Recovery Matrix Spike (Percent)	Recovery Matrix Spike Duplicate (Percent)	RPD (Percent)
Arsenic	106	105	1
Barium	99	98	1
Cadmium	93	92	1
Chromium	94	93	1
Lead	97	96	1
Mercury	93	94	1
Selenium	111	111	0
Silver	112	112	0

The percent solids/percent moisture analyses on the cleanout solids samples were performed in triplicate on sample #1. Sample #2 was split into three samples and each sample analyzed in duplicate. All results were within the data quality goal of 25 percent. Table 6-2 shows a summary of the results as reported by the laboratory.

Table 6-2. Summary of Replicate Percent Solids Results

Parameter	Sample Result Percent Solids	Duplicate Sample Percent Solids	RPD (Percent)
Sample 2-1	38	36	5.4
Sample 2-2	38	40	5.1
Sample 2-3	38	39	2.6

6.1.2 Accuracy

Accuracy is defined for water quality analyses as the difference between the measured value or calculated sample value and the true value of the sample. Spiking a sample matrix with a known amount of a constituent and measuring the recovery obtained in the analysis is a method of determining accuracy. Using laboratory performance samples with a known concentration in a specific matrix can also monitor the accuracy of an analytical method for measuring a constituent in a given matrix. Accuracy is usually expressed as the percent recovery of a compound from a sample. The following equation will be used to calculate percent recovery:

$$\text{Percent Recovery} = [(A_T - A_i) / A_s] \times 100\% \quad (6-2)$$

where:

A_T = Total amount measured in the spiked sample

A_i = Amount measured in the un-spiked sample

A_s = Spiked amount added to the sample

The laboratory ran a matrix spike and a spike duplicate for the metals sample from the TCLP. Table 6-3 shows the results of these analyses. All results were within the established data objective of 75 to 125 percent recovery. The laboratory also analyzed a lab control sample for accuracy. These results are also shown in Table 6-3 and are within the control limits.

Table 6-3. Laboratory Control Sample Results

Parameter	Recovery Lab Control Sample (Percent)	Recovery Lab Control Duplicate (Percent)	RPD (Percent)
Arsenic	106	106	0
Barium	101	100	1
Cadmium	100	99	1
Chromium	99	98	1
Lead	100	100	0
Mercury	97	88	10
Selenium	113	113	0
Silver	111	111	0

6.2 Field Flow Measurements

Flow measurement equipment was calibrated and maintained in accordance with the manufacturer's recommendations. Attachment F of the test plan (Appendix B) provides the flowmeter and sampler data acquisition operation and maintenance procedures. The flowmeters were set and checked following the procedures described by American Sigma. The rain gauge was inspected and cleaned as necessary after each rainfall to ensure proper operation.

6.3 Quality Assurance Reports

The laboratory-provided Quality Assurance Reports were submitted with each data package.

NSF performed a field audit in July 2003 and discussed all of the field procedures with PCG. The Field Observation Forms and recent photographs were reviewed and found to be complete. The ASI lab manager and project coordinator met with the team at PCG's office and the needs for QA reports discussed. The laboratory acknowledged that QC reports would be part of the lab reports submitted at the end of the verification test.

Chapter 7

Vendor-Supplied Information

The information and data contained in this section of the report is provided by the technology vendor, SMI, and has not verified by the Testing Organization or the Verification Organization.

This chapter summarizes two tests performed by Stormwater Management, Inc. at their Portland, Oregon headquarters. The purpose of the tests was to quantify the discharge from the StormScreen treatment system relative to driving head (the height of water above the StormScreen cartridge discharge point) and to demonstrate the ability to discharge water at the design flow rate in a full-scale application with clean water.

The tests were conducted to verify whether the diminished flow capacity conditions experienced during verification testing was a function of a design limitation associated with the StormScreen, or environmental conditions, such as pollutant loading. The testing procedures and data were not collected in accordance with the procedures outlined in the protocol or test plan.

7.1 Testing Equipment

Testing was performed at the Stormwater Management Inc. (SMI) testing and demonstration facility, located at their Portland, Oregon headquarters. This facility consists of a series of full-scale models from the SMI product line, a pumping and conveyance system, and a reservoir tank, which holds approximately 3,800 gallons. The StormScreen model at the facility contains four standard StormScreen cartridges mounted on a single aluminum discharge flume within a standard 6-ft by 12-ft concrete vault, as shown in Figure 7-1. Water discharged from the StormScreen vault through the discharge flume to the outlet bay, shown in Figure 7-3, where it was piped back to the reservoir tank. Water was pumped to the StormScreen from the reservoir via an eight-inch steel pipe by a 15-horsepower Berkeley centrifugal pump. Flow was restricted by a gate valve upstream of the StormScreen inlet pipe which was controlled by a Bray Series 70 electric actuator, as shown in Figure 7-2. Flow was monitored by a Data Industrial 200 Series impeller gage with a 1500 Series LCD readout. Stage was measured in inches relative to the top of the discharge flume.



Figure 7-1. StormScreen testing and demonstration system.



Figure 7-2. Electrically actuated control valve and in-line flowmeter.



Figure 7-3. Effluent bay of StormScreen testing vault, showing rectangular discharge flume and 8-in return pipe to reservoir.

7.2 Stage/Discharge Relationship Test without Float Valves

The purpose of this test was to quantify the discharge from the StormScreen relative to driving head in a full-scale application with no pollutant loading. The test data was collected with the following assumptions:

1. Flow through the StormScreen will be measured at steady state and will not account for the siphon effect that occurs during normal design applications.
2. Flow measurements will not account for possible backwater conditions caused by the structural design of the testing facility.

Both of these effects would serve to dampen the discharge through the system and negatively bias the measurable flow observed in this study. The results will therefore be a conservative estimate of the system's hydraulic performance capacity.

7.2.1 Procedure

The siphon function of the StormScreen cartridges was disabled by removing the float valves from the cartridge center tubes and loosening the top caps, opening the cartridges to atmospheric pressure. This allowed the flow through the system to be held at steady state throughout the range of water elevations from the base to the top of each cartridge relative to the discharge

flume. All screens were cleaned of debris, and trash usually left in the vault for demonstration purposes was removed.

Water was pumped to the StormScreen, and water elevation (stage) was measured in inches relative to the top of the discharge flume. Pumping was initiated at a very slow rate until the water level in the vault remained constant. Flow was then increased slightly in incremental steps by adjusting the control valve. Steady state was achieved at each step, and flow and stage were measured in two- to three-minute increments. Flow was increased in this manner until stage reached 16 inches. At this level, flow and stage were decreased and recorded in the same stepwise manner until the initial conditions were reached.

7.2.2 Results

The discharge results during rising were reduced to a per-cartridge basis, and compared to the water elevations in the StormScreen during rising and falling flow conditions. The results are plotted in Figure 7-4.

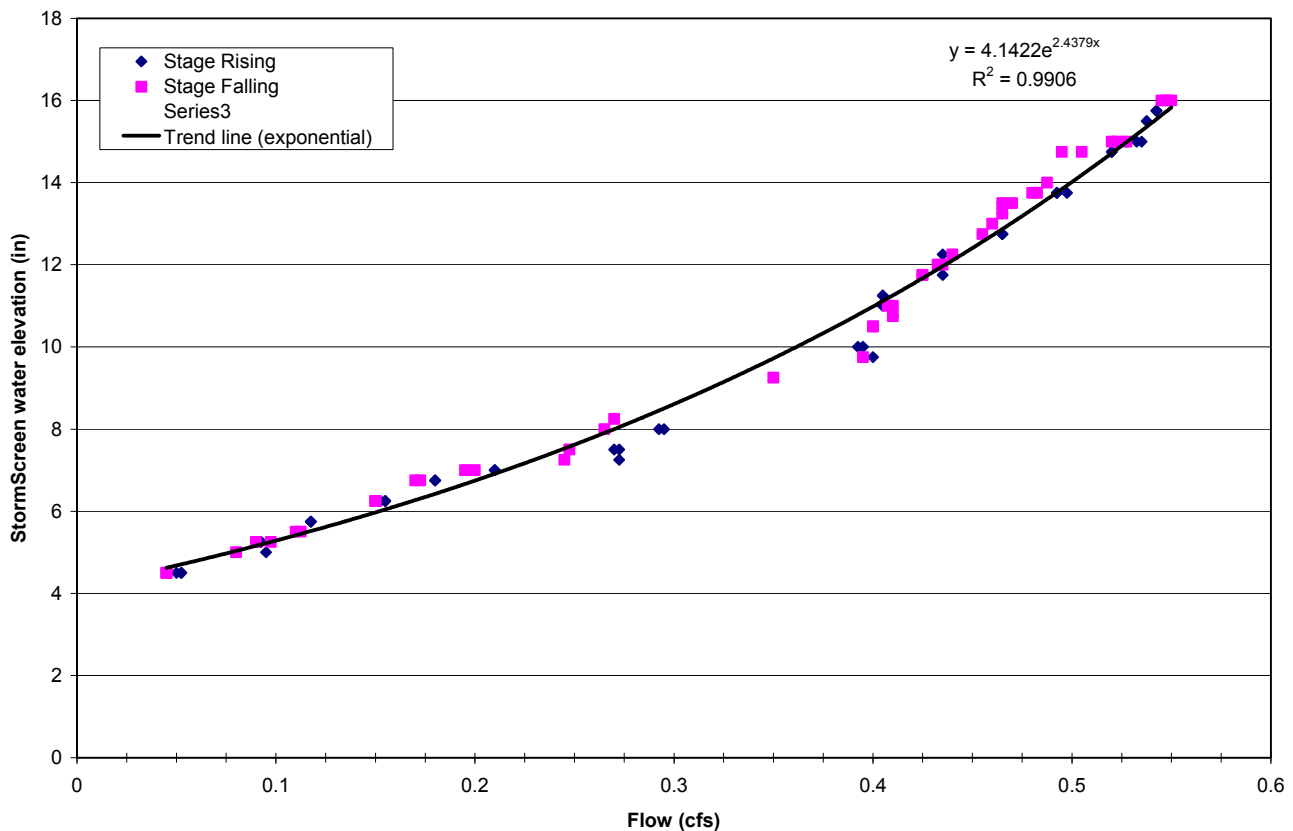

Figure 7-4. StormScreen stage versus flow relationship without float valves.

The plot shows that the 0.5 cfs per cartridge design discharge rate is achieved with a driving head of less than 15 inches. These results were obtained under steady-state conditions without the

siphon action created by the floats in the cartridges, and may have been influenced by minor backwater conditions in the StormScreen effluent bay. As both of these conditions would add negative bias to the observed results, this data should be viewed as a conservative estimate of the StormScreen cartridge clean water discharge potential.

7.3 Stage/Discharge Relationship Test with Float Valves

A second test was performed to demonstrate the ability of the StormScreen to discharge water at the design flow rate with the floats in the StormScreen cartridges. The objective of this test was to measure stage relative to the discharge flume at steady influent flow rates up to 0.5 cfs per cartridge (2 cfs for the four cartridges on the manifold). Constant or falling stage readings at the 2 cfs influent flow rate would indicate that water volume was discharging from the StormScreen at, or greater than, the influent flow rate.

7.3.1 Procedure

Prior to testing, the float valves were reinstalled in the cartridge center tubes and the top caps were secured. Stage was recorded in one-minute increments using an ISCO 6700-series automated sampler with a 750-series flow module. A low-profile area-velocity probe was calibrated and secured to the discharge flume to measure water elevation. Flow was recorded in two- to three- minute increments throughout the test. The times at which the floats raised were also noted.

Clean water was pumped into the StormScreen vault at an initial rate of 2-cfs for 20 minutes, causing the float valves to lift, reset, and lift again. Flow was then dropped to 1.5 cfs for about ten minutes. After float valves lifted again, flow was further reduced to 1 cfs for an additional 10 minutes. Flow was then increased to 2 cfs, and float valves were observed to lift and reset twice before flow was increased to 2.14 cfs and returned to 2 cfs over 20 minutes. Following the last lifting of float valves, flow was terminated.

7.3.2 Results

Results of the testing were plotted, as shown in Figure 7-5. Float valves in the cartridge center tubes restrict flow through the system until the water elevation relative to the cartridge base reaches about 19 inches, at which point the float buoyancy causes the float to lift, the valve to open, and the water discharge rapidly through the discharge flume until float valves reset. The initial peak stage measurement was understated due to the rapid initial filling of the vault relative to the one-minute data recording interval. Float reset occurs between approximately 9 and 11 inches. Small peaks seen up to 14:20 are due to noise associated with the calibration of the area/velocity probe.

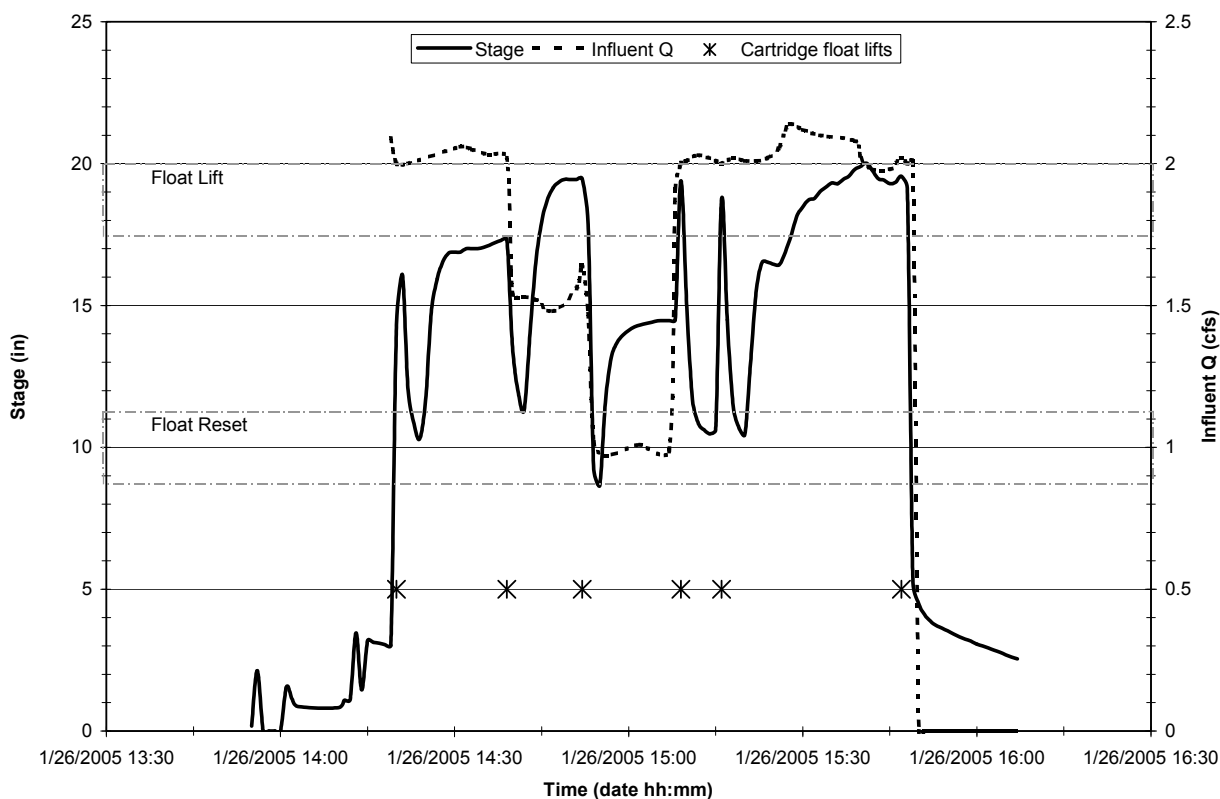

Figure 7-5. StormScreen stage versus flow relationship with float valves.

Due to slight differences in cartridge installation elevation, not every cartridge float reset to a closed position after all floats initially lifted. Thus, periods of near steady stage are observed during which peak flow is maintained by several cartridges while the remaining cartridges discharge only at the nominal “trickle” rate. Stage slowly rises during these periods until the final float(s) are lifted, at which point the stage drops rapidly. At no point did stage surpass the top of the cartridge hood (21 inches), even when the influent flow exceeded 2 cfs over a period of 15 minutes. The rapid stage decrease observed during the separate periods of 2 cfs influent flow demonstrates that the StormScreen float valves consistently lift and allow discharge in excess of the influent flow.

7.4 Conclusion

Based on the results of these tests, the four-cartridge StormScreen system was able to discharge at rates in excess of 0.5-cfs per cartridge. After lifting, floats did not interfere with or diminish the hydraulic capacity of the system. This is consistent with the results of the previous stage/discharge study under steady-state conditions and indicates that the StormScreen system, with no pollutant loading, meets its hydraulic performance claim of 0.5-cfs discharge per cartridge.

Chapter 8 References

1. NSF International and PCG, Inc. *Environmental Technology Verification Test Plan For Stormwater Management, Inc., StormScreen, TEA-21 Project Area, City of Griffin, Spalding County, Georgia*, June 2003.
2. NSF International. *ETV Verification Protocol Stormwater Source Area Treatment Technologies*. U.S. EPA Environmental Technology Verification Program; EPA/NSF Wet-weather Flow Technologies Pilot. March 2002 (v. 4.1).
3. National Oceanic and Atmospheric Association (2000). "Technical Paper No. 40 Rainfall Frequency Atlas of the United States."

Glossary

Accuracy—a measure of the closeness of an individual measurement or the average of a number of measurements to the true value and includes random error and systematic error.

Precision—a measure of the agreement between replicate measurements of the same property made under similar conditions.

Protocol—a written document that clearly states the objectives, goals, scope, and procedures for the study. A protocol shall be used for reference during vendor participation in the verification-testing program.

Quality Assurance Project Plan—a written document that describes the implementation of quality assurance and quality control activities during the life cycle of the project.

Residuals—the waste streams, excluding final effluent, which are retained by or discharged from the technology.

Wet-Weather Flows Stakeholder Advisory Group—a group of individuals consisting of any or all of the following: buyers and users of stormwater treatment and other technologies, developers and vendors, consulting engineers, the finance and export communities, and permit writers and regulators.

Standard Operating Procedure—a written document containing specific procedures and protocols to ensure that quality assurance requirements are maintained.

Technology Panel—a group of individuals with expertise and knowledge of stormwater treatment technologies.

Testing Organization—an independent organization qualified by the verification organization to conduct studies and testing of mercury amalgam removal technologies in accordance with protocols and test plans.

Vendor—a business that assembles or sells treatment equipment.

Verification—to establish evidence on the performance of stormwater treatment technologies under specific conditions, following a predetermined study protocol(s) and test plan(s).

Verification Organization—an organization qualified by USEPA to verify environmental technologies and to issue verification statements and verification reports.

Verification Report—a written document containing all raw and analyzed data, all QA/QC data sheets, descriptions of all collected data, a detailed description of all procedures and methods used in the verification testing, and all QA/QC results. The test plan(s) shall be included as part of this document.

Verification Statement—a document that summarizes the verification report reviewed and approved and signed by USEPA and NSF.

Verification Test Plan—a written document prepared to describe the procedures for conducting a test or study according to the verification protocol requirements for the application of a stormwater treatment technology. At a minimum, the test plan shall include detailed instructions for sample and data collection, sample handling and preservation, precision, accuracy, goals, and quality assurance and quality control requirements relevant to the technology and application.

Appendices

- A SMI Design and O&M Guidelines**
- B Verification Test Plan**
- C Standard Operating Procedure for Solids Cleanout**
- D Event Hydrographs and Rain Distribution**
- E Observation Forms and Photographs**
- F Analytical Data Reports with QC**