

US EPA ARCHIVE DOCUMENT

September 2003  
03/07/WQPC-SWP

# Environmental Technology Verification Report

## In-Drain Treatment Technologies Equipment Verification

### Hydro Compliance Management, Inc. Hydro-Kleen™ Filtration System

Prepared by



NSF International



Under a Cooperative Agreement with  
U.S. Environmental Protection Agency

ET ✓ ET ✓ ET ✓

THE ENVIRONMENTAL TECHNOLOGY VERIFICATION  
PROGRAM



U.S. Environmental  
Protection Agency



NSF International

**ETV Joint Verification Statement**

TECHNOLOGY TYPE:	CATCH BASIN INSERT	
APPLICATION:	IN-DRAIN TREATMENT TECHNOLOGY	
TECHNOLOGY NAME:	HYDRO-KLEEN™ FILTRATION SYSTEM	
TEST LOCATION:	ANN ARBOR, MICHIGAN	
COMPANY:	HYDRO COMPLIANCE MANAGEMENT, INC.	
ADDRESS:	912 NORTH MAIN STREET SUITE 100 ANN ARBOR, MICHIGAN 48104	PHONE: (800) 526-9629 FAX: (734) 332-7972
WEB SITE:	<a href="http://www.hydrocompliance.com">http://www.hydrocompliance.com</a>	
EMAIL:	<a href="mailto:hcm@hydrocompliance.com">hcm@hydrocompliance.com</a>	

NSF International (NSF) manages the Water Quality Protection Center (WQPC) under the U.S. Environmental Protection Agency's (EPA) Environmental Technology Verification (ETV) Program. NSF evaluated the performance of the Hydro Compliance Management, Inc. Hydro-Kleen™ Storm Water Filtration System, a catch basin insert designed to mitigate hydrocarbon, suspended solids, and metals concerns from storm water and human-generated surface runoff. Testing was completed at the NSF laboratory in Ann Arbor, Michigan.

EPA created the ETV Program to facilitate the deployment of innovative or improved environmental technologies through performance verification and dissemination of information. The goal of the ETV program is to further environmental protection by accelerating the acceptance and use of improved and more cost-effective technologies. ETV seeks to achieve this goal by providing high quality, peer reviewed data on technology performance to those involved in the design, distribution, permitting, purchase, and use of environmental technologies.

ETV works in partnership with recognized standards and testing organizations; stakeholder groups consisting of buyers, vendor organizations, and permittees; and with the full participation of individual technology developers. The program evaluates the performance of innovative technologies by developing test plans that are responsive to the needs of stakeholders, conducting field or laboratory tests (as appropriate), collecting and analyzing data, and preparing peer reviewed reports. All evaluations are conducted in accordance with rigorous quality assurance protocols to ensure that data of known and adequate quality are generated, and that the results are defensible.

## TECHNOLOGY DESCRIPTION

The following technology description is provided by the vendor and does not represent verified information.

The Hydro-Kleen™ Filtration System is a patented, multi-media filtration system with sedimentation containment and overflow bypass protection. The systems are designed to fit within existing catch basins in locations such as parking lots, truck bays, and other paved areas. They are also sometimes placed downstream from "hot spots" such as gas stations, parking lots, and other industrial/commercial sites with higher contaminant loadings. Each system is custom manufactured, for retrofit or specification, to fit specific catch basins or drain sumps. The tested system was designed to fit within an East Jordan Iron Works Model 5105 catch basin frame.

The Hydro-Kleen™ system consists of a stainless steel rim attached to a molded polyethylene housing, which is separated into two chambers. Water enters a sedimentation chamber, where heavy suspended solids and debris passing through the grate are collected, then passes through transition outlets along the top of the sedimentation chamber into the filtration chamber. The primary media in the filtration chamber is designed to remove hydrocarbons by adsorption to a hydrophobic cellulose material (Sorb-44). The secondary media in the chamber is a blend of activated carbon (AC-10) designed to remove most remaining hydrocarbons and a variety of other contaminants from the water. Treated water then passes through the bottom of the filtration chamber into the catch basin. In situations where the flow to the system exceeds the capacity of the filtration chamber (up to an equivalent of one-half inch of rain per hour), water is diverted through bypass outlets, preventing flooding or ponding at the catch basin. A complete description of the system is provided in the verification report.

## VERIFICATION TESTING DESCRIPTION

### *Methods and Procedures*

The testing methods and procedures employed during the study were outlined in the Verification Test Plan for Hydro Compliance Management, Inc. Hydro-Kleen™ Filtration System. The Hydro-Kleen™ system was placed in a specially designed testing rig to simulate a catch basin receiving surface runoff. The rig was designed to provide for controlled dosing and sampling, and to allow for observation of system performance.

The Hydro-Kleen™ system was challenged by a variety of hydraulic flow and contaminant load conditions to evaluate the system's performance under normal and elevated loadings. Two additional tests were conducted at the vendor's request to determine the media's hydrocarbon capacity at continuous flow, and to evaluate system performance at reduced suspended solids loading.

A synthesized wastewater mixture containing petroleum hydrocarbons (gasoline, diesel fuel, motor oil, and brake fluid), automotive fluids (antifreeze and windshield washer solvent), surfactants, and sediments (sand, topsoil and clay), was used to simulate constituents found in surface runoff from a commercial or industrial setting. Influent and effluent samples were collected and analyzed for several parameters, including total petroleum hydrocarbons (TPH), oil & grease (O&G), and total suspended solids (TSS). Complete descriptions of the testing and quality assurance/quality control (QA/QC) procedures are included in the verification report.

## PERFORMANCE VERIFICATION

### *System Installation and Maintenance*

The Hydro-Kleen™ system was found to be durable and easy to install, requiring no special tools. The vendor made several modifications to the system housing during installation, including changes to the rim and openings in the chambers of the housing. The modifications are described in the verification report, and the vendor has indicated they will be included in new systems.

Maintenance on the system during testing consisted of cleaning or replacing the filter media bags, and removing sediment and water collected in the sediment chamber. Maintenance took approximately 15 minutes, with the most difficult activity being removal of the storm grate cover. The filter media bags were observed to be slightly different in size and weight from bag to bag, but there was no indication that this impacted the performance of the system.

### ***Hydraulic Capacity***

The hydraulic capacity of the Hydro-Kleen™ system was determined using clean water, synthetic wastewater, and synthetic wastewater with spiked constituents. The capacity was identified as the greatest flow rate achieved before wastewater exited the system through the bypass holes. The testing determined the maximum treated effluent flow rates to be approximately 30 gallons per minute (gpm) with clean water, 22 gpm with synthetic wastewater, and 12 gpm with synthetic wastewater containing elevated (four times normal) constituent concentrations.

The influent flow rate was increased to the maximum flow attainable by the test rig (135 gpm) to determine if the Hydro-Kleen™ system would cause the catch basin to surcharge and flood the surface above the grate. The Hydro-Kleen™ system's bypass holes, which are designed to exceed the maximum hydraulic capacity of the catch basin grate, allowed the entire flow to pass with no surface flooding.

### ***Suspended Solids Removal***

Suspended solids removal efficiency for the system was measured three ways: (1) analytically, by comparing TSS concentrations sampled from the influent and treated effluent; (2) theoretically, by comparing the calculated concentration of suspended solids in the influent (mass of suspended solids fed into water divided by influent water volume) with the analytical concentration of solids in effluent TSS samples; and (3) by a mass balance comparing the dry weight of suspended solids added to the influent with the dry weight of suspended solids removed from the system (the two chambers and the media) during cleaning. The different methods yielded results with a high degree of variability.

The mean influent TSS concentration was 400 mg/L. The analytical method showed a mean removal efficiency of 51 percent, with a range of minus 60 to 100 percent. The theoretical method showed a mean efficiency of 82 percent, with a range of 55 to 100 percent. These efficiency calculations do not take into account the wastewater that bypassed filtration through the filter holes. The mass balance method showed removal efficiency by the system between 46 and 75 percent.

### ***Media Blinding/Bypass***

During most tests, the system showed evidence of filter media blinding and bypass of untreated influent before reaching the filter media's hydrocarbon capacity. The manufacturer's operation and maintenance (O&M) manual includes a procedure, when media blinding is observed, of removing the filter media bags from the housing, shaking them, and placing them back into the filtration chamber. This procedure was tested and a temporary elimination of bypass flows was observed; however, the filter media blinded off quickly when loading was resumed. This observation is shown graphically in Figure 1.

Tests conducted with varying influent hydrocarbon and TSS concentrations showed that the rate of blinding was significantly impacted by the combination of TSS and hydrocarbons in the influent. An additional test was run in which TSS and hydrocarbons were added to the influent for a day, followed by a day of dosing where the hydrocarbons were removed from the influent. When hydrocarbons were not injected into the synthetic wastewater, the rate of media blinding decreased and stabilized. When hydrocarbons were reintroduced to the influent, media blinding resumed at the same rate as in the initial period. No media blinding was observed during a test in which the influent wastewater was injected with hydrocarbons, but no TSS.

Filter media blinding can be related to the mass of hydrocarbon-impacted TSS entering the system. The testing demonstrated that every three pounds of hydrocarbon-impacted TSS treated by the system reduced the treated effluent flow rate by approximately 10 percent.

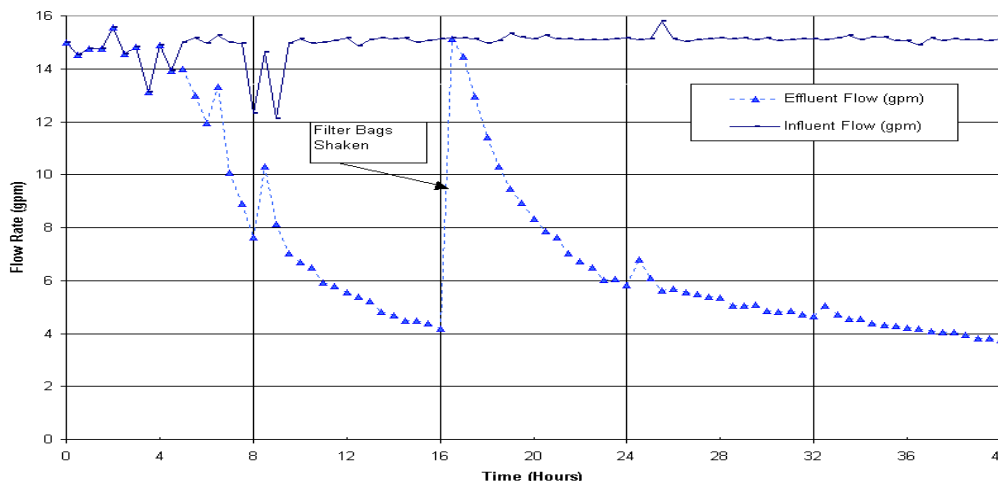

**Figure 1. Influent versus effluent flows following filter media maintenance.**

**Hydrocarbon Removal**

Hydrocarbon Reduction: Based on TPH and O&G analytical data, a comparison of influent and effluent samples collected during all test phases showed that a properly maintained Hydro-Kleen™ system was capable of reducing hydrocarbon concentrations in the treated effluent. The treatment efficiencies shown in Table 1 do not take into account the wastewater that bypassed filtration. The vendor recommends maintenance on the filter media bags whenever media blinding is observed; however, the test plan restricted maintenance events to evaluate the rate of media blinding. Details on media blinding rates are expressed further in the verification report.

**Table 1. Treatment Efficiency Measured by TPH and O&G**

Statistical measure	TPH			O&G		
	Influent (mg/L)	Effluent (mg/L)	Percent reduction	Influent (mg/L)	Effluent (mg/L)	Percent reduction
Average	48	13	77	62	13	78
Median	47	11	81	65	14	78
Maximum	88	22	95	126	19	97
Minimum	10	<10	32	7.8	5.5	29
Standard Deviation	24	3.8	0.2	31	4.6	0.2

Note: Statistical measures based on 17 sets of TPH samples and 15 sets of O&G samples.

Hydrocarbon Capacity: The hydrocarbon capacity test used a stock hydrocarbon solution (gasoline, diesel fuel, motor oil and brake fluid) having a density of 803 grams per liter (6.69 pounds/gallon). Approximately 28,800 L (7,600 gal) of water was fed to the test unit during the capacity test. The stock hydrocarbon solution was mixed into water to achieve a mean TPH concentration of 135 mg/L and a mean O&G concentration of 173 mg/L. The TPH removal efficiency at the start of the test was 82 percent, dropping to 30 percent at the end of the test. Based on the TPH data, the hydrocarbon capacity of the media was approximately 2,890 grams (6.36 pounds). The results for O&G followed a similar pattern,

with an initial removal efficiency of 84 percent and an ending removal efficiency of 22 percent. Based on the O&G data, the hydrocarbon capacity of the media was approximately 2,930 grams (6.45 pounds).

***Nutrient and Surfactant Treatment***

The Hydro-Kleen™ system was ineffective at treating nutrients (e.g., nitrates, ammonia, total Kjeldahl nitrogen) and surfactants (methylene blue active substances [MBAS]) in the wastewater, which was consistent with the vendor’s claims.

***Metals Treatment***

The vendor claims that the Hydro-Kleen™ system can treat organically bound metals, such as metals in used oil, but is ineffective at treating metals dissolved in an aqueous solution. The synthetic wastewater contained low concentrations of dissolved-phase metals, but no organically bound metals. Consistent with vendor claims, the testing showed the Hydro-Kleen™ system to be ineffective at removing metals.

***Quality Assurance/Quality Control***

During the testing, NSF personnel uninvolved with the test completed a technical systems audit to ensure that the testing was in compliance with the test plan. NSF also completed a data quality audit of at least 10 percent of the test data to ensure that the reported data represented the data generated during testing. In addition to QA/QC audits performed by NSF, EPA QA personnel conducted a quality systems audit of NSF's QA Management Program.

<i>Original signed by</i>		<i>Original signed by</i>	
<i>Lee A. Mulkey</i>	<i>10/23/03</i>	<i>Gordon Bellen</i>	<i>10/30/03</i>
_____ Lee A. Mulkey	_____ Date	_____ Gordon Bellen	_____ Date
Acting Director		Vice President	
National Risk Management Laboratory		Research	
Office of Research and Development		NSF International	
United States Environmental Protection Agency			

<i>Original signed by</i>		<i>Original signed by</i>	
<i>Gordon Bellen</i>	<i>10/30/03</i>	<i>Gordon Bellen</i>	<i>10/30/03</i>
_____ Gordon Bellen	_____ Date	_____ Gordon Bellen	_____ Date
Vice President		Vice President	
Research		Research	
NSF International		NSF International	

NOTICE: Verifications are based on an evaluation of technology performance under specific, predetermined criteria and the appropriate quality assurance procedures. EPA and NSF make no expressed or implied warranties as to the performance of the technology and do not certify that a technology will always operate as verified. The end user is solely responsible for complying with any and all applicable federal, state, and local requirements. Mention of corporate names, trade names, or commercial products does not constitute endorsement or recommendation for use of specific products. This report is not an NSF Certification of the specific product mentioned herein.

**Availability of Supporting Documents**

Copies of the Protocol for the Verification of In-Drain Treatment Technologies, April 2001, the verification statement, and the verification report (NSF Report #03/07/WQPC-SWP) are available from the following sources:

- ETV Water Quality Protection Center Program Manager (order hard copy)
  - NSF International
  - P.O. Box 130140
  - Ann Arbor, Michigan 48113-0140

- NSF web site: <http://www.nsf.org/etv> (electronic copy)
- EPA web site: <http://www.epa.gov/etv> (electronic copy)

(NOTE: Appendices are not included in the verification report, but are available from NSF upon request.)

September 2003

# Environmental Technology Verification Report

## Hydro Compliance Management, Inc. Hydro-Kleen™ Filtration System

Prepared for

NSF International  
Ann Arbor, Michigan  
and  
U.S. Environmental Protection Agency  
Edison, New Jersey

Prepared by

NSF International  
Ann Arbor, Michigan  
and  
Scherger Associates  
Ann Arbor, Michigan

September 2003



## Notice

The U.S. Environmental Protection Agency (EPA) through its Office of Research and Development has financially supported and collaborated with NSF International (NSF) under a Cooperative Agreement. This verification effort was supported by the Water Quality Protection Center operating under the Environmental Technology Verification (ETV) Program. This document has been peer reviewed and reviewed by NSF and EPA and recommended for public release.

## Foreword

The following is the final report on an Environmental Technology Verification (ETV) test performed for NSF International (NSF) and the United States Environmental Protection Agency (EPA). The verification test for the Hydro-Kleen™ Filtration System was conducted from February 10 through March 17, 2003, at NSF Headquarters in Ann Arbor, Michigan.

The U.S. Environmental Protection Agency (EPA) is charged by Congress with protecting the Nation's land, air, and water resources. Under a mandate of national environmental laws, the Agency strives to formulate and implement actions leading to a compatible balance between human activities and the ability of natural systems to support and nurture life. To meet this mandate, EPA's research program is providing data and technical support for solving environmental problems today and building a science knowledge base necessary to manage our ecological resources wisely, understand how pollutants affect our health, and prevent or reduce environmental risks in the future.

The National Risk Management Research Laboratory (NRMRL) is the Agency's center for investigation of technological and management approaches for preventing and reducing risks from pollution that threaten human health and the environment. The focus of the Laboratory's research program is on methods and their cost-effectiveness for prevention and control of pollution to air, land, water, and subsurface resources; protection of water quality in public water systems; remediation of contaminated sites, sediments and ground water; prevention and control of indoor air pollution; and restoration of ecosystems. NRMRL collaborates with both public and private sector partners to foster technologies that reduce the cost of compliance and to anticipate emerging problems. NRMRL's research provides solutions to environmental problems by: developing and promoting technologies that protect and improve the environment; advancing scientific and engineering information to support regulatory and policy decisions; and providing the technical support and information transfer to ensure implementation of environmental regulations and strategies at the national, state, and community levels.

This publication has been produced as part of the Laboratory's strategic long-term research plan. It is published and made available by EPA's Office of Research and Development to assist the user community and to link researchers with their clients.

## Contents

Verification Statement .....	VS-i
Notice .....	ii
Foreword .....	iii
Contents .....	iv
Figures .....	vi
Tables .....	vii
Acronyms and Abbreviations .....	viii
Acknowledgements .....	ix
Chapter 1 Introduction .....	1
1.1 ETV Purpose and Program Operation .....	1
1.2 Testing Participants and Responsibilities .....	1
1.2.1 U.S. Environmental Protection Agency .....	2
1.2.2 NSF International—Verification Organization (VO) .....	2
1.2.3 NSF International Laboratory—TO .....	3
1.2.4 Vendor .....	4
1.3 Verification Testing Site .....	4
Chapter 2 Hydro-Kleen™ Equipment Description and Operating Processes .....	5
2.1 Equipment Description .....	5
2.1.1 Modifications to Unit Provided for Testing .....	6
2.2 Hydro-Kleen™ Filtration System Capabilities and Claims .....	6
Chapter 3 Verification Testing Procedures .....	8
3.1 Testing Objectives .....	8
3.2 Test Equipment .....	8
3.2.1 Laboratory Test Instrumentation .....	10
3.2.1.1 Water Flow Monitoring/Control .....	10
3.2.1.2 Constituent Feed Devices .....	11
3.2.2 Synthetic Wastewater .....	12
3.3 Laboratory Analytical Constituents .....	13
3.4 General Test Procedures .....	14
3.4.1 Clean Test Rig and Unit .....	15
3.4.2 Install New Filter Media .....	15
3.4.3 Weigh Constituent Stock Solutions and Set Constituent Feed Rates .....	15
3.4.4 Set Flow Condition .....	15
3.4.5 Record Flow Data .....	15
3.4.6 Collect Samples .....	15
3.4.7 Conclude Testing .....	16
3.4.8 System Component Operation and Maintenance Performance .....	16
3.5 Test Phases Specified in the VTP .....	16
3.5.1 Phase I - Performance under Intermittent Flow Conditions .....	17
3.5.1.1 Procedure .....	17
3.5.1.2 Sample Collection .....	17
3.5.1.3 Flow Monitoring .....	17
3.5.2 Phase II – Determination of the Capacity of the Unit .....	17

3.5.2.1	Procedure .....	17
3.5.2.2	Sample Collection.....	18
3.5.2.3	Flow Monitoring .....	18
3.5.3	Phase III – Performance under Varied Hydraulic and Concentration Conditions ....	18
3.5.3.1	Procedure .....	18
3.5.3.2	Sample Collection.....	19
3.5.3.3	Flow Monitoring .....	19
3.5.4	Phase IV– Contaminant Capacities at High Hydraulic Throughput .....	19
3.5.4.1	Procedure .....	19
3.5.4.2	Sample Collection.....	19
3.5.4.3	Flow Monitoring .....	19
3.6	Additional Tests Not Specified in the VTP .....	20
3.6.1	Hydrocarbon Capacity Test (Phase V).....	20
3.6.1.1	Procedure .....	20
3.6.1.2	Sample Collection.....	20
3.6.1.3	Flow Monitoring .....	20
3.6.2	Reduced Constituent Concentrations Tests .....	20
3.6.2.1	Procedure .....	21
3.6.2.2	Sample Collection.....	21
3.6.2.3	Flow Monitoring .....	21
3.7	Installation and Operation & Maintenance Observations .....	21
3.7.1	Residue Management .....	21
3.7.2	Operation & Maintenance Procedures .....	22
Chapter 4	Verification Testing Results and Discussion .....	23
4.1	Synthetic Wastewater Composition.....	23
4.1.1	Theoretical TSS Concentration.....	23
4.2	Synthetic Wastewater Laboratory Analytical Results .....	24
4.2.1	BTEX/MTBE and TOC Analysis Issue .....	25
4.3	Test Phases in VTP .....	26
4.3.1	Phase I - Performance under Intermittent Flow Conditions .....	26
4.3.1.1	Analytical Data .....	26
4.3.1.2	Flow Data .....	28
4.3.2	Phase II – Determination of the Capacity of the Unit.....	30
4.3.2.1	Analytical Data .....	30
4.3.2.2	Flow Data .....	31
4.3.3	Phase III – Performance under Varied Hydraulic and Concentration Conditions ....	31
4.3.3.1	Flow Data .....	32
4.3.3.2	Analytical Data .....	33
4.3.4	Phase IV– Contaminant Capacities at High Hydraulic Throughput .....	34
4.3.4.1	Analytical Data .....	35
4.3.4.2	Flow Data .....	36
4.3.5	Phases I-IV Data Summary and Discussion .....	36
4.4	Additional Test Phases.....	39
4.4.1	Hydrocarbon Capacity Test (Phase V).....	39
4.4.1.1	Flow Data .....	39
4.4.1.2	Analytical Data .....	40

4.4.2 Reduced Constituent Concentrations Tests ..... 41  
 4.4.2.1 Procedures, Flow Data and Discussion..... 41  
 4.4.3 Installation and Operation & Maintenance Findings ..... 43  
 4.4.3.1 Installation..... 43  
 4.4.3.2 Filter Media Bags..... 43  
 4.4.3.3 General O&M/System Cleanout ..... 44  
 4.4.3.4 Waste Material Characterization..... 45  
 4.5 Summary of Findings..... 46  
 4.6 Vendor Comments ..... 47  
 Chapter 5 Quality Assurance/Quality Control..... 50  
 5.1 Audits..... 50  
 5.2 Precision..... 50  
 5.2.1 Laboratory Precision Measurements..... 50  
 5.2.2 Field Precision Measurements ..... 52  
 5.3 Accuracy ..... 54  
 5.4 Representativeness..... 55  
 5.5 Completeness ..... 55  
 References ..... 57  
 Appendices..... 58  
 A Verification Test Plan with Operations and Maintenance Manual..... 58  
 B Laboratory Analytical Reports..... 58  
 C Testing Equipment Specifications. .... 58  
 D Audit Report..... 58  
 Glossary ..... 59

**Figures**

Figure 2-1. Schematic of Hydro-Kleen™ filtration system. .... 5  
 Figure 2-2. Hydro-Kleen™ drip lip modification..... 6  
 Figure 3-1. Testing rig schematic. .... 9  
 Figure 3-2. Catch basin grate on testing rig. .... 10  
 Figure 3-3. Sand and topsoil feeder. .... 11  
 Figure 4-1. Phase I influent vs. treated effluent flow rates and cumulative loss. .... 28  
 Figure 4-2. Phase III influent and effluent flow bar chart. .... 33  
 Figure 4-3. Theoretical TSS mass vs. bypass--Phases I, II, IV, and IV-R. .... 39  
 Figure 4-4. Phase V mass of hydrocarbon removed vs. mass fed. .... 40  
 Figure 4-5. Comparison of reduced constituent concentrations flow data with Phase I, II, and IV-R flow data. .... 42  
 Figure 4-6. Top of filtration chamber after Phase I (left) and Phase III (right) testing. .... 45

## Tables

Table 3-1. Synthetic Wastewater Mix Stock Concentrations .....	12
Table 3-2. Analytical Concentrations of Synthetic Wastewater Mix .....	14
Table 4-1. Constituent Feed Rate Summary .....	23
Table 4-2. Synthetic Wastewater Analytical Data Comparison .....	25
Table 4-3. Phase I Analytical Data Summary.....	27
Table 4-4. Phase I Flow Data Summary .....	29
Table 4-5. Phase II Analytical Data Summary .....	31
Table 4-6. Phase II Influent and Effluent Flow Summary.....	32
Table 4-7. Phase III Influent and Effluent Flow Summary .....	33
Table 4-8. Phase III Analytical Data Summary .....	34
Table 4-9. Phase IV-R Analytical Summary .....	35
Table 4-10. Phase IV-R Flow Data Summary .....	37
Table 4-11. TPH and O&G Treatment Efficiency Summary .....	37
Table 4-12. Comparison of Mean Analytical and Theoretical Influent TSS Concentrations.....	37
Table 4-13. Phase V Analytical Data Summary .....	40
Table 4-14. Dry Weight of Filter Media Bags Before Testing .....	44
Table 4-15. Dry Weight of Sediment Retained by Hydro-Kleen™ System.....	46
Table 5-1. Duplicate Laboratory Sample RPD Summary .....	51
Table 5-2. Laboratory MS/MSD Data Summary.....	51
Table 5-3. Duplicate Field Sample RPD Summary .....	52
Table 5-4. Laboratory Control Sample Data Summary .....	54

## Acronyms and Abbreviations

BETX	Benzene, ethylbenzene, toluene, xylene
BMP	Best management practice
°C	Celsius degrees
COD	Chemical Oxygen Demand
DQI	Data Quality Indicators
EPA	U.S. Environmental Protection Agency
ETV	Environmental Technology Verification
g	Gram(s)
gal	Gallon(s)
gpm	Gallon(s) per minute
HCM	Hydro Compliance Management, Inc.
Kg	Kilogram(s)
L	Liters
LAS	Dodecylbenzenesulfonic acid
lb	Pound
MBAS	Methylene blue active substances
MTBE	Methyl-tertiary butyl ether
NRMRL	National Risk Management Research Laboratory
mg/L	Milligram(s) per liter
mL	Milliliter(s)
NSF	NSF International
NIST	National Institute of Standards and Technology
OBC	Oil-based constituents
O&G	Oil and grease
O&M	Operation and maintenance
QA	Quality Assurance
QC	Quality Control
RCRA	Resource Conservation and Recovery Act
RPD	Relative percent difference
S/T	Sand and topsoil
STPP	Sodium tripolyphosphate
TCLP	Toxicity characteristic leaching procedure
TKN	Total Kjeldahl nitrogen
TO	Testing Organization
TOC	Total organic carbon
TPH	Total petroleum hydrocarbons
TSS	Total suspended solids
VO	Verification Organization (NSF)
VTP	Verification test plan
WQPC	Water Quality Protection Center
WSC	Water-soluble constituents

## Acknowledgements

NSF International and Scherger Associates were responsible for all elements in the testing sequence, including test setup, calibration and verification of instruments, data collection and analysis, data management, data interpretation, and the preparation of this report.

NSF International  
789 N. Dixboro Road  
Ann Arbor, Michigan 48105  
Contact Person: Patrick Davison

Scherger Associates  
3017 Rumsey Drive  
Ann Arbor, Michigan 48105  
Contact Person: Dale Scherger

The vendor of the equipment is:

Hydro Compliance Management, Inc.  
912 North Main Street, Suite 100  
Ann Arbor, Michigan 48104  
Contact Person: David Woelkers

The Testing Organization thanks Sascha Reder and Salah Aridi of the NSF Hydraulics Laboratory for their many hours spent designing and preparing the test rig and their assistance during testing. Also, special thanks to Kerri LeVanseler, Ph.D., Karen Jones, Michael Richards, Kelly Kendall, Jaclyn Ratkowski, and Keith Dumas of the NSF Chemistry Laboratory for their assistance in developing the synthetic wastewater composition, analytical support, and sample container management. Thanks, too, to Walter Roudebush and Michael Movinski of TriMatrix Laboratories, Inc. who provided assistance with the analytical aspect of the testing program. Finally, thanks goes to Hydro Compliance Management's David Woelkers for his support throughout the test program.



# Chapter 1

## Introduction

### 1.1 ETV Purpose and Program Operation

The U.S. Environmental Protection Agency (EPA) has created the Environmental Technology Verification (ETV) Program to facilitate the deployment of innovative or improved environmental technologies through performance verification and dissemination of information. The ETV Program's goal is to further environmental protection by substantially accelerating the acceptance and use of improved and more cost-effective technologies. ETV seeks to achieve this goal by providing high-quality, peer-reviewed data on technology performance to those involved in the design, distribution, permitting, purchase, and use of environmental technologies.

ETV works in partnership with recognized standards and testing organizations (TOs); stakeholders groups that consist of buyers, vendor organizations, and permittees; and the full participation of individual technology developers. The program evaluates the performance of innovative technologies by developing test plans that are responsive to the needs of stakeholders, conducting field or laboratory tests (as appropriate), collecting and analyzing data, and preparing peer-reviewed reports. All evaluations are conducted in accordance with rigorous quality assurance/quality control (QA/QC) protocols to ensure that data of known and adequate quality are generated and that the results are defensible.

NSF International (NSF) operates the Water Quality Protection Center (WQPC) in cooperation with EPA. The Source Water Protection Area of the WQPC evaluated the performance of the Hydro Compliance Management, Inc. (HCM) Hydro-Kleen™ Stormwater Filtration System, which is an in-drain device designed to remove hydrocarbons, organically bound metals, sediments, and other organic chemical compounds from commercial or industrial runoff and wet weather flow. This document provides the verification test results for the HCM Hydro-Kleen™ Filtration Device.

It is important to note that verification of the equipment does not mean that the equipment is “certified” by NSF or “accepted” by EPA. Rather, it recognizes that the performance of the equipment has been determined and verified by these organizations for those conditions tested by the TO.

### 1.2 Testing Participants and Responsibilities

The ETV testing of the Hydro-Kleen™ Filtration Device was a cooperative effort between the following participants:

- EPA
- NSF
- Scherger Associates
- HCM

The following is a brief description of each ETV participant and their roles and responsibilities.

### **1.2.1 U.S. Environmental Protection Agency**

The EPA Office of Research and Development, through the Urban Watershed Branch, Water Supply and Water Resources Division, NRMRL, provides administrative, technical, and QA guidance and oversight on all ETV WQPC activities. This peer-reviewed document has been reviewed by NSF and EPA and recommended for public release.

The key EPA contact for this program is:

Mr. Ray Frederick, Project Officer, ETV Source Water Protection Program  
(732) 321-6627 e-mail: [Frederick.Ray@epamail.epa.gov](mailto:Frederick.Ray@epamail.epa.gov)

USEPA, NRMRL  
Urban Watershed Management Research Laboratory  
2890 Woodbridge Ave. (MS-104)  
Edison, NJ 08837-3679

### **1.2.2 NSF International—Verification Organization (VO)**

NSF is EPA's verification partner organization for administering the WQPC. NSF is a not-for-profit testing and certification organization dedicated to public health safety and the protection of the environment. Founded in 1946 and located in Ann Arbor, Michigan, NSF has been instrumental in the development of consensus standards for the protection of public health and the environment. NSF also provides testing and certification services to ensure that products bearing the NSF Name, Logo, or Mark meet those standards.

The NSF personnel and management who provided technical oversight of the verification process were separate from the NSF personnel who conducted the testing. An audit of the laboratory analytical and data gathering and recording procedures was conducted. NSF also provided review of the Verification Test Plan (VTP) and this Verification Report.

NSF's responsibilities as the VO include:

- Review and comment on the VTP;
- Review the quality systems of all parties involved with the TO and subsequently, qualify the TO;
- Oversee the TO activities related to the technology evaluation and associated laboratory testing;
- Carry out an on-site audit of test procedures;
- Oversee the development of a Verification Report and Verification Statement;
- Coordinate with EPA to approve the Verification Report and Verification Statement;
- Provide QA/QC review and support for the TO.

Key contacts at NSF for the VTP and program are:

Mr. Thomas Stevens, Program Manager  
(734) 769-5347 e-mail: [Stevenst@NSF.org](mailto:Stevenst@NSF.org)

Ms. Maren Roush, Project Coordinator  
(734) 827-6821 e-mail: [MRoush@NSF.org](mailto:MRoush@NSF.org)

NSF International  
789 Dixboro Road  
Ann Arbor, Michigan 48105  
(734) 769-8010

### ***1.2.3 NSF International Laboratory—TO***

The NSF Laboratory acted as the TO for the verification testing, with technical consultation provided by Scherger Associates. The NSF Hydraulic Laboratory has the space and large-scale equipment (tanks, pumps, etc.) to perform the testing on the Hydro-Kleen™ unit, and the NSF Analytical Laboratory has the equipment and experience to perform the analytical work for this VTP. Scherger Associates has experience in VTP development and execution and supported NSF personnel in these areas.

The TO provided all needed logistical support, established a communications network, and scheduled and coordinated activities of all participants. The TO was responsible for ensuring that the testing location and feed water conditions were such that the verification testing could meet its stated objectives. The TO prepared the VTP; oversaw the testing; managed, evaluated, interpreted, and reported on the data generated by the testing; and reported on the performance of the technology.

TO employees manufactured and prepared the testing rig, assured the required test conditions were met, and measured and recorded data during the testing. The TO's Project Manager provided oversight of the daily tests.

NSF provided the analytical laboratory services for the testing program, subcontracting with TriMatrix Laboratories, Inc. of Grand Rapids, Michigan (TriMatrix) for selected analytical services as specified later in this report.

The key personnel and contacts for the TO are:

#### NSF– Project Manager

Mr. Patrick Davison, Project Coordinator  
(734) 913-5719 e-mail: [davison@nsf.org](mailto:davison@nsf.org)

#### NSF– Laboratory Support

##### Hydraulics Laboratory Contact:

Mr. Sal Aridi, Group Leader  
(734) 769-8010, Ext. 2298 e-mail: [aridi@nsf.org](mailto:aridi@nsf.org)

##### Chemistry Laboratory Contact:

Dr. Kerri LeVanseler, Technical Manager  
(734) 769-8010, Ext. 2367 e-mail: [levanseler@nsf.org](mailto:levanseler@nsf.org)

**NSF - QA Support**

Ms. Theresa Uscinowicz, QA & Safety Specialist  
(734) 769-8010, Ext. 2257 e-mail: [uscinowicz@nsf.org](mailto:uscinowicz@nsf.org)

NSF International  
789 Dixboro Road  
Ann Arbor, Michigan 48105

**Scherger Associates**

Mr. Dale Scherger, Consultant  
(734) 213-8150 e-mail: [daleres@aol.com](mailto:daleres@aol.com)

Scherger Associates  
3017 Rumsey Drive  
Ann Arbor, MI 48105

**1.2.4 Vendor**

HCM is the vendor of the Hydro-Kleen™ Filtration System. The vendor was responsible for supplying a field-ready Hydro-Kleen™ unit and filter media, and was available during all tests to provide technical assistance as needed.

**Contact Information:**

David Woelkers, President  
(800) 526-9629 e-mail: [dwoelkers@hydrocompliance.com](mailto:dwoelkers@hydrocompliance.com)

Hydro Compliance Management, Inc.  
912 North Main Street, Suite 100  
Ann Arbor, MI 48104

**1.3 Verification Testing Site**

The verification testing was performed at NSF's headquarters in Ann Arbor, Michigan. The testing rig was set up in the NSF Hydraulics Laboratory, which is capable of performing a wide array of hydraulic tests and research programs. The Hydraulics Laboratory is equipped with water storage tanks of up to 10,000 gallons and pumps and pipes with adequate volume to provide a constant water supply of over 100 gpm (gallons per minute) for testing purposes.

Samples of the synthetic wastewater mixture used for testing were analyzed in the NSF Wet Chemistry and Trace Metals Laboratories, which are located in the same building as the Hydraulics Laboratory. The NSF Exposures Laboratory prepared sample bottles, labels, and preservatives for the ETV Program testing.

## Chapter 2

### Hydro-Kleen™ Equipment Description and Operating Processes

#### 2.1 Equipment Description

The Hydro-Kleen™ Filtration System is a patented multi-media filtration design that includes sediment containment and protection against surface flooding. Each unit of this in-drain treatment technology is manufactured to fit the specific catch basin or drain invert. Units are placed into existing catch basins by removing the grate/cover, inserting the unit into the basin, and replacing the cover. As water flows into the unit, the water is directed into a sedimentation chamber, which collects coarse sediment, solids, and debris passing through the inlet grate. Water then passes from a transition inlet at the top of the sedimentation chamber into the filtration chamber. The first media, Sorb-44, is a hydrophobic pulp material that absorbs hydrocarbons. The second media is an activated carbon (AC-10) that removes any remaining hydrocarbons in the water, but also may remove a variety of metals and other contaminants in the runoff. Water then passes through the bottom of the system and into the catch basin.

To provide overflow protection and ensure sufficient flow can pass through the catch basin or drain inlet during heavy runoff events, the unit is designed to bypass larger flows in order to eliminate flooding from backup. Figure 2-1 shows the Hydro-Kleen™ Filtration System.

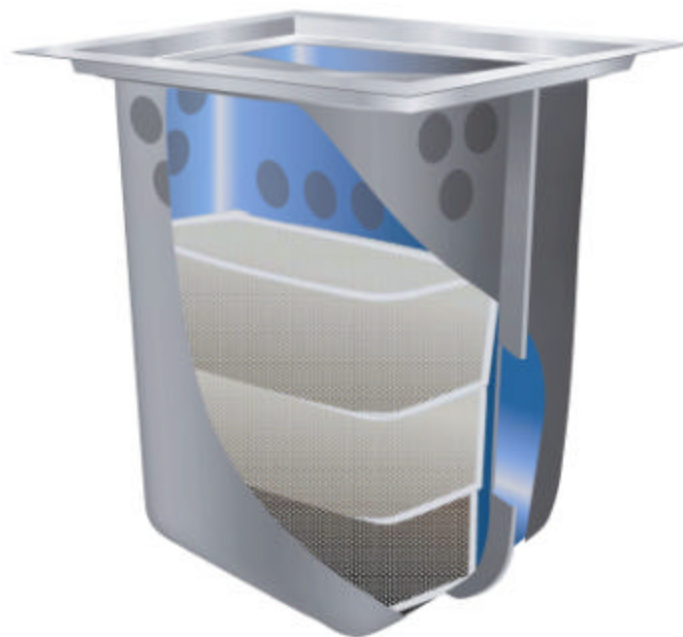
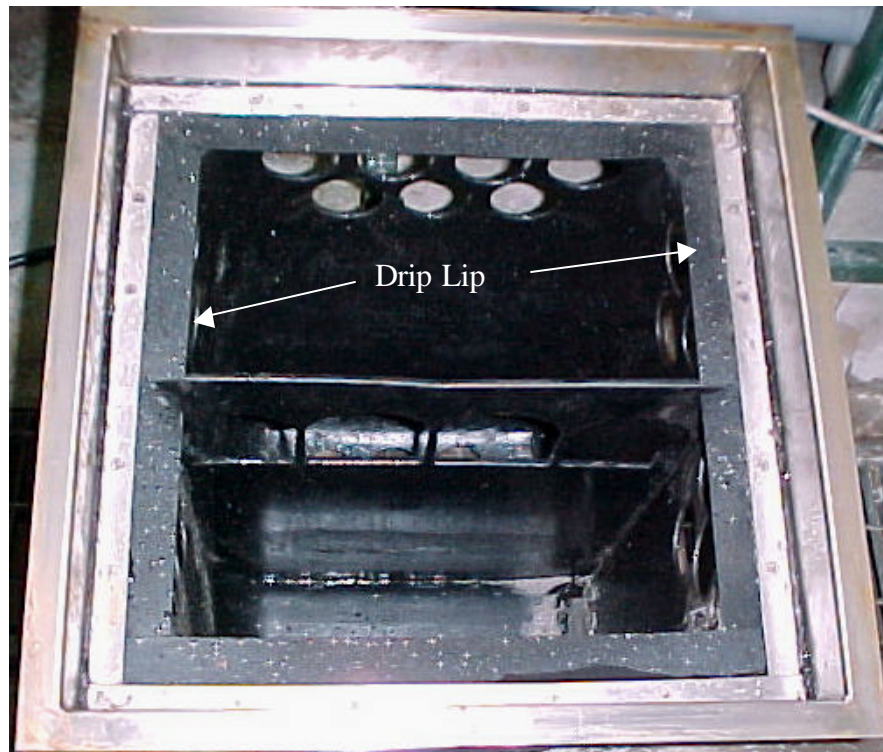

Figure 2-1. Schematic of Hydro-Kleen® filtration system.

### 2.1.1 Modifications to Unit Provided for Testing

After completion of the VTP and prior to testing, the vendor modified the Hydro-Kleen™ unit offered for testing. The first modification added a “drip lip,” which consists of a thin plastic brim inserted between the stainless steel flange and the body of the unit. The drip lip deflected water toward the middle of the sediment chamber to prevent water from channeling along the sides of the unit and through the bypass holes (see Figure 2-2).



**Figure 2-2. Hydro-Kleen™ drip lip modification.**

The second modification changed the transition inlet holes between the sedimentation chamber and the filtration chamber from round circles to a “keyhole” design. The four keyholes measured 4 in. wide by 4.75 in. tall, and the bottom of the keyhole was 16.25 in. from the bottom of the unit. This modification was done to allow water entering the filtration chamber and contacting the filter media to flow across a wider surface area, preventing uneven loading of contaminants into the filter media.

## 2.2 Hydro-Kleen™ Filtration System Capabilities and Claims

HCM claims Hydro-Kleen™ Filter Systems are an effective technology available for use with floor and area drains and storm water catch basins to trap solids and substantially reduce contaminant levels from storm water and other non-point source runoff. The unit is designed for application in typical storm water collection systems that have inlet drains and catch basins. The unit has the advantage that there are no utility requirements and no electronic or mechanical

control systems to fail. HCM also claims that when utilized with a regular maintenance program, the Hydro-Kleen™ unit is an effective best management practice (BMP) to assist governments and private business in meeting discharge permits and other water runoff requirements for protecting surface water quality.

The vendor claims it will typically treat all of the storm water entering the unit up to flows of approximately 50 gpm. Flow rates above this level will result in storm water bypassing the filter media and discharging directly to the collection system. The unit has the advantage of being fed by gravity from the drainage area rather than being installed in a collection system pipe. The unit is designed to bypass flows at a rate greater than the flow that can enter the catch basin or drain inlet through the grate, so head loss and flow restrictions will not cause collection system backups. The Hydro-Kleen™ unit does not require extensive installation because each unit is manufactured to fit the existing catch basin or drain into which it is inserted.

Treatment is limited to the capacity of the unit to trap contaminants. The unit must be maintained on a regular schedule to prevent saturation of the filter media by contaminants and blockage from solids and debris buildup. Removing the cover, vacuuming debris from the sedimentation chamber, and replacing the filters completes unit maintenance, which the vendor indicates takes less than 15 minutes to complete. The vendor recommends changing the filters every four to six months. Temporary maintenance can be done by removing debris accumulated on the filter media, shaking the filter media bags, and placing them back into the system. Removal of solids and debris may be needed more often depending on the location and season. For example, cleanout is recommended after a heavy leaf fall.

The vendor claims that the media from a typical drain system, such as that used for parking lots, outdoor maintenance areas, etc., can be disposed to Class II landfills because the media is non-leaching. Applications for other uses may require disposal with a licensed facility depending on the contaminant load.

## Chapter 3

### Verification Testing Procedures

#### 3.1 Testing Objectives

The objective of in-drain treatment system verification testing under the ETV *Source Water Protection Protocol for In-Drain Treatment Technologies* (February 2002) is to evaluate the contaminant removal performance and operational and maintenance performance of commercially available systems, following sound testing procedures and appropriate quality assurance and control.

The objective of this testing was to determine the performance attained by the Hydro-Kleen™ Filtration System when used to treat water containing a variety of contaminants resulting from human-generated flows. The contaminants include those present in maintenance areas, parking lots, gasoline stations, truck stops, and the "first flush" from storm water. The contaminants include sediments and automotive fluids.

The objective was achieved by implementing testing procedures presented in the protocol and VTP (Appendix A). A synthesized wastewater containing sediments, petroleum hydrocarbons, and surfactants was prepared to simulate contaminants at concentrations typically found in surface water runoff at a commercial or industrial setting. The treatment system was challenged under a variety of hydraulic loading conditions utilizing the synthetic wastewater. Influent and effluent samples collected from the unit were measured for various contaminants as determined by indicator tests (e.g., Chemical Oxygen Demand, Total Petroleum Hydrocarbons, Total Suspended Solids) and by chemical specific tests (e.g., benzene or toluene). The results were used to calculate removal efficiencies and system capacities, and to determine the system treatment effectiveness. Other parameters were monitored as secondary constituents to meet the ETV objective of providing an overall assessment of the technology that can be used by permit writers, buyers, and users of the technology.

The treatment system was also monitored for operation and maintenance characteristics, including the performance and reliability of the equipment and the level of operator maintenance required.

#### 3.2 Test Equipment

The Hydro-Kleen™ unit was placed in a specially designed testing rig that simulates a drain in a surface runoff condition. The testing rig controlled influent and effluent flow and constituent feed rates. The rig also provided for collection of influent and effluent liquid samples for laboratory analysis, and observation of performance conditions, such as bypass, in a simple and effective manner.

Figure 3-1 shows the process flow diagram and equipment configuration for the test setup. City water stored in a 10,000 gallon holding tank served as the main water feed. Oil-based constituents (OBC) (gasoline, diesel fuel, motor oil, and brake fluid) and water-soluble constituents (WSC) (windshield washer fluid, antifreeze, and surfactants), including clay, were stored in two-liter decanters and fed by variable-speed peristaltic pumps into the riser pipe



containing the water. The water, OBC, and WSC mixture poured into an open channel measuring 35.5 in. long by 11.75 in. wide. This is a slight deviation from the VTP, which indicated the OBC and WSC would be added to the water directly into the open channel. The modification was deemed necessary by the TO after preliminary tests and observations showed that injecting the constituents into the open channel did not provide adequate mixing to allow collection of a representative influent sample. A dry feeder above the channel dispensed sand and topsoil (S/T) into the water stream at controlled rates.

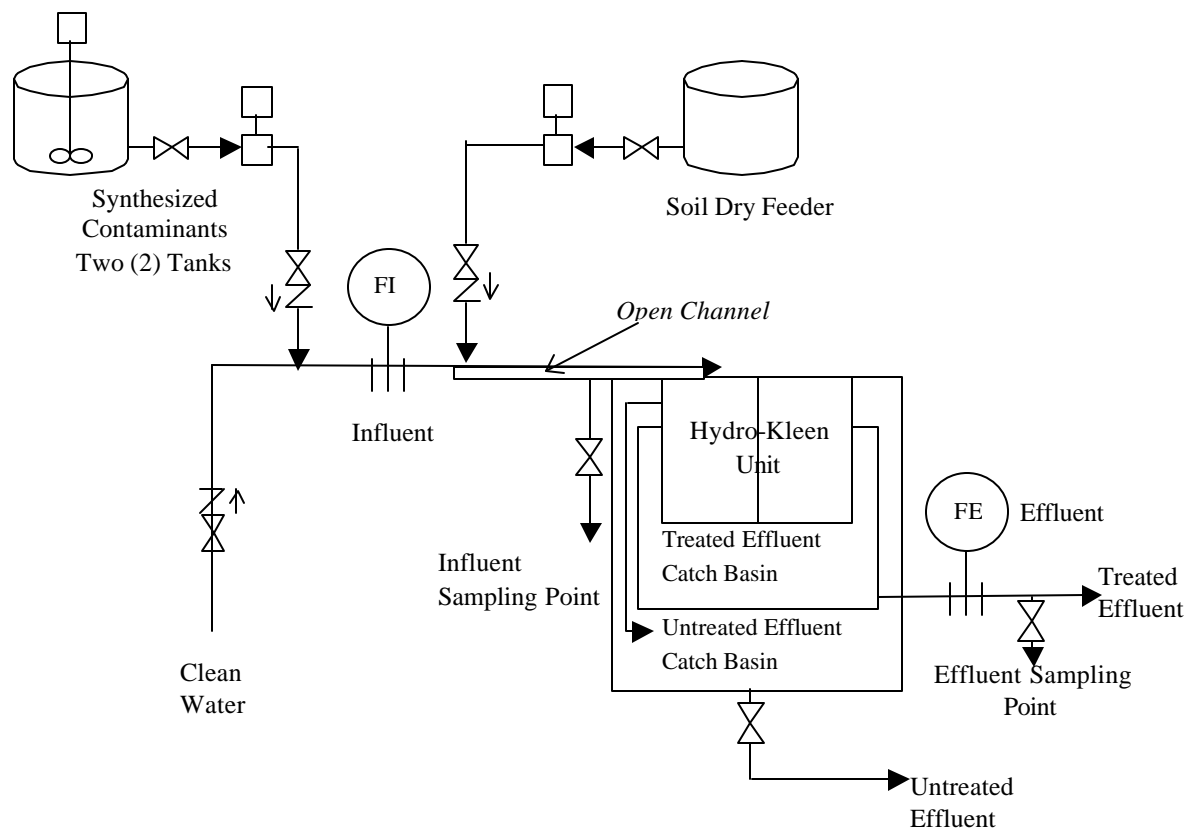

**Figure 3-1. Testing rig schematic.**

The water and constituent mixture flowed to the end of the open channel and dropped approximately six inches onto a round plastic tray measuring six feet in diameter (Figure 3-2). In the center of the round plastic tray were the storm grate and Hydro-Kleen™ unit. The end of the open channel was the influent sampling point. After the water flowed into the unit, the treated effluent was separated from the water that exited the unit through the bypass holes. The treated effluent was piped to a discharge point at the end of the pipe, where it flowed into a floor drain in the Hydraulic Laboratory. The end of the pipe was the treated effluent sampling point. Untreated bypass water was captured in a large plastic tub and discharged to the sanitary floor drain at a separate location.

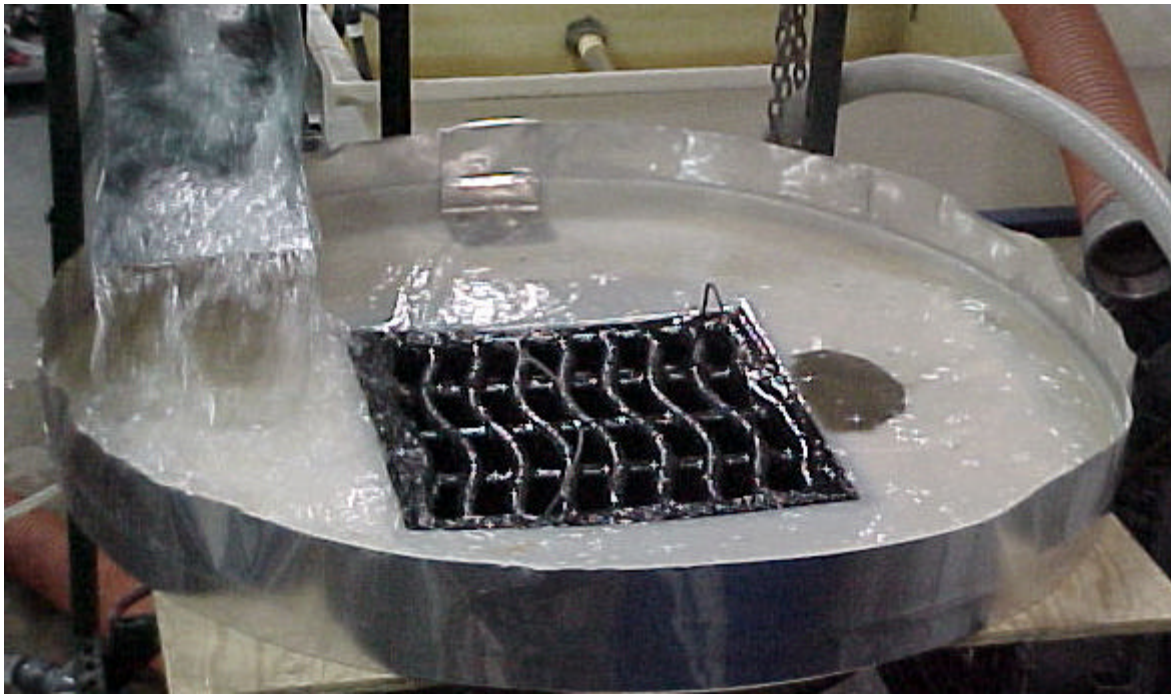

**Figure 3-2. Catch basin grate on testing rig.**

### **3.2.1 Laboratory Test Instrumentation**

#### **3.2.1.1 Water Flow Monitoring/Control**

The clean water feed for the synthetic wastewater mixture was potable water stored in a 10,000 gallon holding tank located in the NSF Hydraulics Laboratory. The water was pumped from the tank to the sampling rig using a five horsepower pump through two-inch galvanized steel piping and flexible tubing. A valve in the two-inch pipe was used to control the flow.

The influent flow piping was equipped with a paddle-wheel flow meter to measure flows greater than 30 gpm and a digital turbine flow meter to measure flows less than 30 gpm. Valves on the influent flow piping could be opened and closed as needed to direct water through the appropriate pipe and flow meter. The pipe transporting the treated effluent was equipped with a paddle-wheel flow meter.

The flow meters were calibrated after installation using catch-and-weigh methods. During testing, flow rates were monitored with the flow meters, and checked manually using catch-and-weigh techniques. This was especially important for effluent flow monitoring. Although the effluent flow meter calibration checks were within  $\pm 5$  percent, the effluent paddle-wheel flow meter frequently failed to operate properly, due either to constituents adhering to the paddle wheel or low effluent flow rates, resulting in a flow rate reported as zero gpm. When this occurred, effluent flow was measured exclusively by catch-and-weigh methods.

During certain test conditions, water exited the Hydro-Kleen™ system through the bypass holes. When this occurred, the bypass flow rate was calculated by subtracting the treated effluent flow rate from the influent flow rate.

The catch-and-weigh flow monitoring method was performed throughout setup and testing. The entire flow was collected in a five-gallon bucket over an interval timed with a stopwatch, and the water and bucket were weighed. The flow rate (gpm) was then calculated using the following equation:

$$\text{Flow} = \frac{(\text{Measured Weight} - \text{Weight of Bucket}) \times 0.1198 \text{ gal/Lb H}_2\text{O}}{\text{Time (min)}} \quad (3-1)$$

Equipment specifications for the equipment used during testing are in Appendix C.

### 3.2.1.2 Constituent Feed Devices

OBC and WSC constituents were fed into the water using variable-speed peristaltic pumps equipped with 0.062 in. inner diameter tubing. The pumps were calibrated prior to testing by pumping constituents into a graduated cylinder over a timed interval at monitored flow settings. The constituents were poured into two-liter decanters and weighed before and after each test. These weights were used to determine the feed rates for that particular test.

The S/T mixture was fed into the water stream using a storage hopper and a custom-made feeder (see Figure 3-3). The feeder consisted of a 25/64 in. drill bit through a threaded galvanized 2-in. to 1-in. reducer pipe fitting. The drill bit was turned by a variable-speed mixer motor. The feeder was calibrated prior to testing by weighing the S/T mixture passed through the feeder at monitored mixer settings over a timed interval.

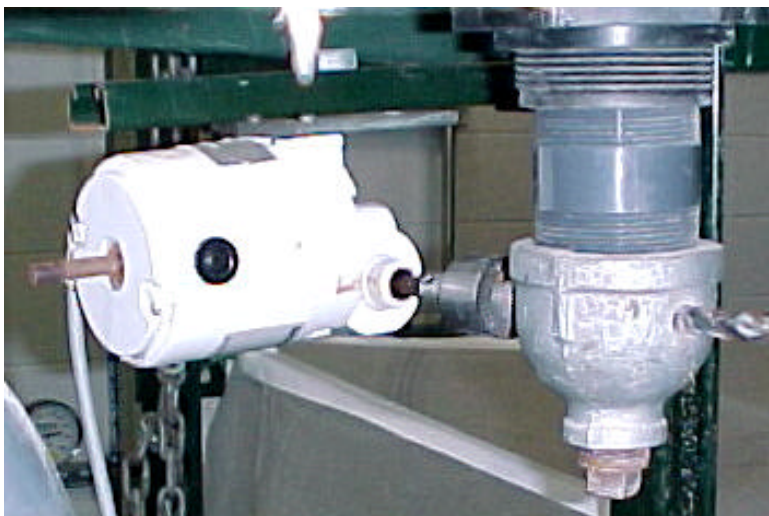

**Figure 3-3. Sand and topsoil feeder.**

### 3.2.2 Synthetic Wastewater

Synthetic wastewater was made by adding a mixture of gasoline, diesel fuel, motor oil, sand, topsoil, clay, antifreeze, and surfactants to the city water. The VTP specifies the synthetic wastewater mix is to contain the stock solutions as specified in Table 3-1.

**Table 3-1. Synthetic Wastewater Mix Stock Concentrations**

<b>Product or Material</b>	<b>Concentration in Water (mg/L)</b>
Regular unleaded gasoline	0.3
Truck diesel fuel	13.6
10W-30 motor oil	68
Brake fluid	3.4
Antifreeze (glycol based)	10
Dodecylbenzenesulfonic acid (LAS)	10
Sodium tripolyphosphate (STPP)	2
Windshield washer fluid	10
Standards soils	300

The following items were purchased to make the stock solutions:

- Regular unleaded gasoline and diesel fuel purchased at a local gas station and stored in plastic gasoline and diesel fuel containers;
- Valvoline<sup>®</sup> 10W30 Motor Oil
- Peak<sup>®</sup> 50/50 Antifreeze
- Meijer<sup>®</sup> Brand Window Wash solvent
- Prestone<sup>®</sup> Super Heavy Duty Brake Fluid
- KT Clays OM-4 Ball Clay
- Leisure Landscapes Play Sand
- Earthgro Topsoil
- Aldrich Sodium Tripolyphosphate (STPP)
- Aldrich Dodecylbenzenesulfonic acid (LAS)

The constituents were mixed to make the OBC and WSC stock solutions in the following ratios:

- OBC mixture (fed into the water at a rate of 0.1 mL OBC per liter of water):
  - 10 grams (g) motor oil
  - 2 g diesel fuel
  - 0.05 g gasoline
  - 0.5 g brake fluid
- WSC mixture:
  - 10 g windshield washer fluid
  - 10 g antifreeze
  - 10 g LAS

- 2 g STPP
  - Mixture diluted to 100 mL with tap water
- Clay/Water mixture (resulting in a volume of 1.3 L of mixture):
  - 1 L water
  - 930 g clay
- The WSC test solution was made by mixing 1.0 L of the WSC with 1.3 L of the clay/water mixture, and the resultant mixture was fed into the water at a flow rate of 0.23 mL WSC/Clay mixture per liter of water.
- S/T mixture:
  - S/T oven-dried at an approximate temperature of 160° F.
  - S/T passed through a No. 14 sieve to remove large particles.
  - Mix at a ratio of 70 percent sand and 30 percent topsoil (by weight).
  - Feed at a rate of 207 mg per liter of water

### 3.3 Laboratory Analytical Constituents

During the various testing phases, samples of the influent and effluent flows were collected for laboratory analysis. The VTP specified when samples were to be collected, the sample collection procedures, and preservation and analytical methods. Based on the unit's capabilities and the composition of the synthetic wastewater, the following list of targeted analytical constituents was selected, as outlined in the VTP:

- Total Petroleum Hydrocarbons (TPH)
- Benzene, Ethylbenzene Toluene, Xylene (BETX)
- Methyl Tertiary Butyl Ether (MTBE)
- Chemical Oxygen Demand (COD) - a common organic content indicator parameter
- Total Organic Carbon (TOC) - a common organic content indicator parameter
- Total Suspended Solids (TSS)

In addition to the primary target list, additional parameters or organic indicator tests can measure performance of the unit. Oil and Grease (O&G), a general organic compound test for petroleum-based materials, has been used for many years but is not as accurate and precise as other indicators. O&G was analyzed but on a less frequent basis.

The vendor claims the Hydro-Kleen™ unit will generally not remove inorganic soluble metals. However, if heavy metals are present as organic-bound material or are sorbed on the solids, some reduction can occur. While metals reduction might be expected in field applications of this unit, where vehicle washing of road grime may have these types of metals present, it is difficult to develop synthetic test water with these types of metal compounds. Therefore, the level of metals present in the synthetic wastewater was low, and metals were measured less frequently than the targeted contaminants. The additional constituent list included:

- O&G
- Metals: aluminum (Al), cadmium (Cd), chromium (Cr), copper (Cu), iron (Fe), lead (Pb), and zinc (Zn)

The protocol provides an additional list of possible constituents, including nutrients, surfactants, and total phenol, that are potential contaminants of concern to be analyzed as part of the test program. These secondary parameters were monitored in a few selected samples in order to provide “background” information. The vendor makes no claims regarding the nutrient reduction capability of the Hydro-Kleen™ unit and does not expect it to treat nutrients in the synthetic wastewater. The secondary constituents included:

- Total phosphorus
- Total Kjeldahl nitrogen (TKN)
- Ammonia nitrogen
- Surfactants (methylene blue active substances (MBAS))
- Total phenol

Based on preliminary testing conducted during preparation of the VTP, the synthetic wastewater had the concentrations summarized in Table 3-2:

**Table 3-2. Analytical Concentrations of Synthetic Wastewater Mix**

<b>Parameter</b>	<b>Concentration (mg/L)</b>
TPH	42
TOC	13
Oil & Grease	52
Benzene	0.002
Ethylbenzene	<0.001
Toluene	0.003
Total Xylenes	0.002
MTBE	<0.001
Total Phenols	0.003
Total Suspended Solids	300
Metals (Al, Cd, Cr, Cu, Fe, Pb, Zn)	2
Surfactants (MBAS)	12
COD	280
PO <sub>4</sub> -P	1
TKN	3
NH <sub>3</sub> -N	0.2

### 3.4 General Test Procedures

The procedures described in this section were conducted for each of the various test phases to be described in Section 3.5. Data and observations noted during testing were recorded in a bound project-specific notebook with sequentially numbered pages or bench sheets.

### **3.4.1 Clean Test Rig and Unit**

The test rig and Hydro-Kleen™ unit was cleaned and inspected prior to each test phase. Test rig cleaning consisted of washing sediments and constituents from the open channel, the tray, and the treated effluent piping. The affected areas were washed with a mixture of warm water and the STPP/LAS detergent and scrubbed with a sponge. The treated effluent piping was disassembled and scrubbed with a pipe brush. The Hydro-Kleen™ system was cleaned by first removing the catch basin grate and the system's diverter shield over the filtration chamber, then removing used filter media and vacuuming water and sediment from the settling chamber. After cleaning, the testing rig was reassembled and rinsed with clean water.

### **3.4.2 Install New Filter Media**

The TO installed new filter media for the Hydro-Kleen™ system supplied by the vendor in accordance with the vendor's operations and maintenance (O&M) instructions. Prior to installation, the filter media was weighed dry, then saturated with tap water and weighed wet. In addition, the activated carbon filter media bags were rinsed with tap water to remove the activated carbon dust. After the new filter media was installed, the system's diverter shield was installed over the filtration chamber, and the catch basin grate was reinstalled.

### **3.4.3 Weigh Constituent Stock Solutions and Set Constituent Feed Rates**

The OBC and WSC/clay solutions were poured into two-liter decanters and weighed prior to each test. Also, the S/T feeder was emptied, the S/T slated for testing was weighed, and the feeder was filled with the weighed S/T mixture. For tests in which the stock solutions required refilling during testing, the additional stock solutions were weighed prior to refilling the containers. The peristaltic pump and mixer dials were then set at the speed required for the particular test.

### **3.4.4 Set Flow Condition**

The influent and effluent totalizers were reset, or the current total flow volume and start time were noted on the bench sheet. The Gould Pump was turned on, water valves opened, and the influent flow meter was referenced to set the appropriate influent flow rate. The peristaltic pumps and mixer were turned on, and their dial settings were noted on the bench sheet. After 30-60 seconds, once flow stabilized, the effluent flow rate was noted on the bench sheet.

As testing commenced, the testing rig was regularly inspected to ensure that proper equipment functionality and flow rates were maintained. Corrective actions, if necessary, were completed and recorded in the notebook or on the bench sheet.

### **3.4.5 Record Flow Data**

Influent and effluent flow data were regularly monitored and recorded during testing. As previously noted, the effluent paddle-wheel flow meter occasionally failed to function properly. Therefore, the effluent flow rates were routinely calculated using the catch-and-weigh method outlined in Section 3.2.1.1.

### **3.4.6 Collect Samples**

Influent and effluent water samples were collected as outlined in the VTP. The influent and effluent sample locations were designed into the testing rig, and the same influent and effluent

sample location points were utilized throughout the tests. The VTP specified that samples be collected either after a specified volume of influent had passed through the unit (e.g., 5,000 gallons) or after a particular time had elapsed (e.g., four hours). The time and influent flow rate when samples were collected were recorded on the bench sheets.

### **3.4.7 Conclude Testing**

After the testing was complete, the constituent feed pumps were shut off and the influent water valve was closed to prevent additional influent flows. The time and final influent flow volume data were recorded on the bench sheet. The OBC and WSC decanters were weighed to determine the remaining contents, and the results were recorded on the bench sheet. In addition, the S/T feeder was emptied, and the residual contents were weighed and recorded on the bench sheet. The catch basin grate and diverter plate on the Hydro-Kleen™ unit were removed, the filter media bags were weighed, and the contents of the settling chamber (sediments and water) were vacuumed and weighed.

The testing time, influent and effluent flow rates, and constituent weights were then transferred to spreadsheets to verify the specific flow and constituent feed rates had been achieved and to conduct further data analysis.

### **3.4.8 System Component Operation and Maintenance Performance**

The overall system performance was measured both quantitatively and qualitatively throughout the testing program. Qualitative measures were assessed by observations of, and experience with, the unit during the setup and testing phases. Records were maintained on the ease and time of both installation and maintenance for cleanout and absorption medium replacement, and other operating observations. The unit was also monitored for solids or debris buildup, clogging of entry paths, and other related operational issues. The O&M manual provided by Hydro Compliance was reviewed for its specificity and completeness. These observations, experiences, records, and review were the basis for evaluating the system performance in terms of operation and maintenance.

## **3.5 Test Phases Specified in the VTP**

The system was tested under varying hydraulic load conditions to simulate typical conditions found in wash water applications (i.e., floor drains, catch basins, and drain inlets in streets, parking lots, etc.). The test phases were delineated in the protocol and VTP. The primary operational characteristics were tested to determine:

- Performance under intermittent flow conditions (Phase I);
- Performance under different hydraulic loadings, including peak flow (Phase II);
- Performance at different constituent loadings (Phase III); and
- Capacity of the unit to contain constituents during high-flow conditions (Phase IV).

The objectives, testing, sample collection, and flow monitoring procedures for each of the tests conducted as part of this ETV program are described in this section; the results and discussion are presented in Chapter 4. Although the testing phases are described sequentially, the protocol and VTP did not require that they be completed in consecutive order, and they were not.



### **3.5.1 Phase I - Performance under Intermittent Flow Conditions**

In Phase I, the system was operated to simulate actual in-drain treatment applications during intermittent loadings, at flow rates that are typical mean flow rates.

#### 3.5.1.1 Procedure

The test was started after the unit was cleaned and new filter media was installed. A constant flow rate of 15 gpm was set over the course of a five-day test, and the standard constituent loadings were used. Each twenty-four hour period consisted of an eight hour ON cycle, followed by a 16-hour OFF cycle. During the ON cycle, the unit received flow for 15 minutes, followed by a 15-minute period with no flow. The result was 16 flow periods in the eight hour ON cycle (two 15-minute flow periods per hour for eight hours).

#### 3.5.1.2 Sample Collection

Samples of both the influent and the effluent were collected by manual grab samples while the unit was receiving flow. Most parameters being monitored were from composite samples over the operating day, whereas BETX and MTBE were grab samples to comply with the EPA sampling method for these constituents. Samples for TSS and TPH analysis were collected manually on a flow-weighted basis (every 800 gallons of flow), and the individual grab samples were combined by the laboratory to generate a flow-weighted composite sample.

On the first and third day of testing, a special sampling program included one-hour composites (eight total) for TSS and COD.

#### 3.5.1.3 Flow Monitoring

Influent and effluent flow rates were monitored during each 15-minute run interval throughout the test period. Cumulative volumes processed during the test were monitored based on the flow rates and the totalizing flow meters.

### **3.5.2 Phase II – Determination of the Capacity of the Unit**

In Phase II, the system was run to “exhaustion” with respect to the capacity of the sorbent material to remove suspended solids or petroleum hydrocarbons.

#### 3.5.2.1 Procedure

The unit was operated under continuous flow conditions until either the unit plugged with solids and the synthetic wastewater exited the unit through the bypass holes, or the contaminant absorption capacity was exceeded.

The VTP called for utilizing the filter media used for the Phase I test if it was in good operating condition after Phase I. The system had new filter media installed and was cleaned prior to Phase II testing due to plugging that occurred during Phase I. In addition, the VTP identified the flow rate for this test to be 40 gpm, which was based on the vendor’s claim of maximum flow capacity of 50 gpm. The protocol specifies this test to be run at approximately 80 percent of the maximum rated flow capacity identified by the vendor, which for the Hydro-Kleen™ was 50 gpm. Phase III, Part 1, which was run before the Phase II test, identified a lower maximum flow capacity (approximately 23 gpm); therefore, for the purpose of the test, the flow rate was set at 18 gpm.

### 3.5.2.2 Sample Collection

Grab samples from the influent and effluent were collected for all testing parameters at the start and end of the test. Grab samples were also collected after 5,500 gallons of flow and were analyzed for TSS and COD.

### 3.5.2.3 Flow Monitoring

Flow rates were monitored a minimum of once per hour throughout the test period. Cumulative volumes processed during the test were monitored based on the flow rates and the totalizers on the flow meters. The flow and totalizer data were recorded on the bench sheets.

## 3.5.3 Phase III – Performance under Varied Hydraulic and Concentration Conditions

The objective of the Phase III testing was to determine the hydraulic capacity of the system and to evaluate whether constituent loading concentrations impacted the hydraulic capacity. Phase III had three distinct parts:

- Part 1: Hydraulic capacity with clean water
- Part 2: Hydraulic capacity with synthetic wastewater
- Part 3: Hydraulic capacity with spiked constituents

In Part 1, the test was performed with clean water only; none of the constituents outlined in Section 3.2.2 were used. In Part 2, the same test was performed with constituents added. In Part 3, the constituents were fed at a concentration four times greater than outlined in Section 3.2.2. The results of this test were used to establish the flow rates employed in Phase II and Phase IV testing.

### 3.5.3.1 Procedure

Parts 1, 2, and 3 of the test were conducted sequentially. The Part 1 test started with a cleaned system and new filter media, and the system was not cleaned until after the Part 3 test was complete.

Each of the three test parts were conducted using the same general procedure, with the primary differences being the inclusion and concentration of the synthetic wastewater constituents, and the collection of samples in Parts 2 and 3. The tests were started utilizing an influent flow rate of 20 gpm for a period of 15 minutes. During this time, the effluent was monitored to assess whether the system was capable of treating all the water or if a portion was passing through the bypass holes. After each 15-minute interval, the flow was increased in 10 gpm increments and maintained for the same 15-minute period. The process was repeated until flow began passing through the bypass holes. The maximum flow rate achieved, before bypass and after bypass, was recorded on the bench sheets.

During the Part 1 test, after achieving the maximum treated rate, the flow was increased further to challenge the bypass system to determine if the Hydro-Kleen™ system reduces the capacity of the drain and promotes surface flooding. Flow continued to be increased until either the bypass was at capacity, causing the unit to flood, or the maximum available fresh water rate of the testing rig (approximately 135 gpm) was reached.

### 3.5.3.2 Sample Collection

No samples were collected for laboratory analysis during the Part 1 test because no synthetic wastewater constituents were added to the water. During Parts 2 and 3, grab samples of the influent and effluent were collected at each flow rate condition (20, 30, 40, 50 gpm, etc.) until the maximum available feed water capacity was reached. All samples were analyzed for TSS and COD. Two sets of influent and effluent samples were collected for TPH, TOC, BTEX, and O&G analysis. One set was collected at the 20-gpm rate, and the second set was collected at the maximum flow rate achieved.

### 3.5.3.3 Flow Monitoring

For each of the three parts of this test, the influent and effluent flow rate was monitored for each 15-minute influent flow rate condition. The results were recorded on bench sheets.

## 3.5.4 *Phase IV– Contaminant Capacities at High Hydraulic Throughput*

To determine the influence on treatment efficiency of high hydraulic loads, the Phase IV test was a treatment capacity or “exhaustion test” similar to Phase II, except the unit was under higher hydraulic loads typical of a very large flow event.

### 3.5.4.1 Procedure

The unit was operated under continuous flow conditions until the unit plugged with solids or the contaminant absorption capacity was exceeded. The test was run after the unit was cleaned and new filter media had been installed.

The VTP identified the flow rate for this test to be 80 gpm. The protocol specifies that this test is to be run at a flow that is approximately 85 percent greater than the maximum rated flow capacity identified by the vendor, which for the Hydro-Kleen™ was 50 gpm. Phase III, Part 1, which was run before the Phase IV test, identified a lower maximum flow capacity; therefore, the flow rate was set at 42 gpm for this test.

### 3.5.4.2 Sample Collection

Samples were collected on a grab sample basis. Influent and effluent samples were collected at the start of the test and after every 10,000 gallons of water treated, and were analyzed for the primary constituents (TSS, COD). Samples of the influent and effluent were collected for TPH, BTEX, TOC, O&G, surfactants, TKN, ammonia, total phosphorus, total phenols, and metals at the start and end of the test.

### 3.5.4.3 Flow Monitoring

Flow rates were monitored a minimum of once per hour throughout the test period. Cumulative volumes processed during the test were monitored based on the flow rates and the totalizers on the flow meters. The flow and totalizer data were recorded on the bench sheets. Observations of the flow rates through the treatment unit and the bypass were used as the primary indicator that solids capacity had been reached. When flow rates in the treated effluent decreased by 25 percent or more for 30 minutes, capacity was considered to have been reached.

### 3.6 Additional Tests Not Specified in the VTP

After the four test phases were complete, additional tests not originally specified in the VTP were run. A hydrocarbon capacity test (designated as Phase V for this VTP, but currently not in the protocol) was conducted at the request of the vendor to determine the treatment capacity of the system when the system was challenged with a petroleum/water mixture only, (i.e., no WSC/clay or S/T was added to the synthetic wastewater mixture). Also, tests reducing the feed rates of the sediments and OBC were run to determine whether lowering the challenge concentrations would significantly impact the system performance.

#### 3.6.1 Hydrocarbon Capacity Test (Phase V)

The Phase V test was performed to eliminate the possible effects of the soils and the WSC on the system's hydrocarbon treatment capabilities.

##### 3.6.1.1 Procedure

The test was started after the unit was cleaned and new filter media was installed. The influent flow rate was set at 18 gpm to be comparable to the flow rates utilized for the Phase I (15 gpm) and the Phase II (18 gpm) tests. The OBC feeder was set at a rate 2.5 times higher than the rate established in Section 3.2.2 to expedite testing.

##### 3.6.1.2 Sample Collection

Samples were collected for a full suite of hydrocarbon analyses (TPH, O&G, BTEX/MTBE, TOC). Initially, only TOC samples were analyzed, and other samples were preserved and held pending the results of the TOC analysis. The TO anticipated that the TOC analyses would provide an indication of the concentration of hydrocarbons in the water.

Once TOC analytical results were received, a portion of the remainder of the samples were submitted for TPH, O&G, and BTEX/MTBE analysis, including samples for:

- Test startup, influent and effluent;
- Last sample before breakthrough, effluent only;
- First sample after breakthrough, effluent only; and
- Test shutdown, influent and effluent.

##### 3.6.1.3 Flow Monitoring

Flow rates were monitored a minimum of a once per hour throughout the test period. Cumulative volumes processed during the test were monitored based on the flow rates and the totalizers on the flow meters. The flow and totalizer data were recorded on the bench sheets.

#### 3.6.2 Reduced Constituent Concentrations Tests

The reduced constituent concentrations tests were conducted to determine whether lowering the concentrations of the synthetic wastewater constituents, especially the S/T and clay, would significantly impact performance of the unit.

During testing, the vendor raised a concern regarding the 300 mg/L solids concentration approved in the protocol and VTP. The protocol was written to reflect "real-world" conditions of runoff, but there are no generally recognized guidelines or mean TSS concentrations published

from which a TSS concentration could be set. After the VTP was approved with a TSS influent concentration of 300 mg/L, the vendor supplied data that proposed the TSS concentration should be no higher than 150 mg/L. The TO indicated the 300 mg/L TSS concentration would not be changed because the VTP had been approved, but agreed that the issue would be evaluated during testing, and if it appeared the TSS concentration was causing the filter media to blind off prematurely, additional testing at reduced TSS concentrations would be performed. The constituent reduction tests were therefore run with a target TSS influent concentration of approximately 150 mg/L to examine the difference this would have on the performance characteristics of the system.

#### 3.6.2.1 Procedure

The tests were performed in the same general manner as the Phase II tests, with the influent flow rate set at a continuous flow rate of 18 gpm, and the system cleaned and new filter media installed prior to testing.

The TO set the S/T feed rate to the lowest possible setting, and gauged the feed rate using the catch-and-weigh method to establish the S/T TSS theoretical concentration of approximately 120 mg/L at an 18 gpm flow. The clay concentration in the WSC/clay mixture was set to reflect the same ratios of clay to S/T in the challenge sediment (70 percent S/T, 30 percent clay). The OBC and WSC feed rates remained the same.

On the morning of the second day of the three-day test, the peristaltic pump tubing on the OBC feeder ruptured, but the TO continued the test without the OBC feed because the constituent reduction test focused primarily on the impacts of sediments, not petroleum hydrocarbons. On the third and final day of testing, the tubing was repaired, and the OBC solution was fed back into the synthetic wastewater.

#### 3.6.2.2 Sample Collection

TSS samples were collected from the effluent stream after 2,000 gallons, 6,500 gallons, 13,000 gallons, 20,000 gallons, and 27,600 gallons of influent entered the system.

#### 3.6.2.3 Flow Monitoring

Flow rates were monitored a minimum of a once per hour throughout the test period. Cumulative volumes processed during the test were monitored based on the flow rates and the totalizers on the flow meters. The flow and totalizer data were recorded on bench sheets.

### 3.7 Installation and Operation & Maintenance Observations

In addition to the various testing phases conducted on the Hydro-Kleen™ system, the VTP specifies that the TO review and evaluate the vendor's written installation and O&M procedures and claims as they pertain to the testing program.

#### 3.7.1 Residue Management

Residues, including sediment in the settling chamber and the filter media, were removed from the unit at the end of testing phases, as outlined in the VTP. Measurements included the volume and weight (wet and dry) of the filter media and the sediments collected within the unit. Waste materials, including the spent filter media and the accumulated sediments, were stored in the

NSF Hydraulics Laboratory pending completion of the test and characterization of the waste material.

Solid residues were collected from the sedimentation chamber in the unit. The sediment was removed using a wet/dry shop vacuum to simulate the typical removal system used in the field (vacuum truck). These solids were measured for wet weight and volume in order to evaluate the amount of solids removed from the unit on a volume throughput/loading basis. The solids were then left in open pans to air-dry to obtain a dry weight.

One representative composite sample of the spent activated carbon, Sorb-44, and sediment collected within the unit was analyzed for Toxicity Characteristic Leachate Procedure (TCLP) metals and organics.

### ***3.7.2 Operation & Maintenance Procedures***

The Hydro-Kleen™ unit was installed and operated by the TO during the test period. The vendor supplied an O&M manual, which was included as an appendix in the VTP (Appendix A) for reference.

The TO personnel maintained a logbook describing observations pertaining to the ease of installation, operation, and maintenance of the unit during the tests.

## Chapter 4 Verification Testing Results and Discussion

### 4.1 Synthetic Wastewater Composition

The protocol and VTP set forth a requirement that the TO maintain constituent feed rates in the synthetic wastewater of  $\pm 50$  percent of the target feed during the course of testing so that the system would be properly challenged. The TO monitored the constituent feed rates throughout testing utilizing the procedures outlined in Chapter 3. The weights of constituents added to the challenge water were used to calculate the constituent feed rates and are summarized in Table 4.1.

**Table 4-1. Constituent Feed Rate Summary**

Date	Test Phase	Constituent Flow Rates		
		OBC (mL/L)	WSC (mL/L)	S/T (mg/L)
2/11/03	III-2	0.11	0.12	203
2/14/03	III-3 <sup>a</sup>	0.56	0.17	1,250
2/17/03	I	0.12	0.22	308
2/18/03	I	0.12	0.15	276
2/19/03	I	0.11	0.23	246
2/20/03	I	0.12	0.16	207
2/21/03	I	0.12	0.20	225
2/24/03	I	0.12	0.16	176
2/26/03	IV <sup>b</sup>	0.12	0.00	254
2/27/03	IV-R <sup>b</sup>	0.10	0.15	194
3/4/03	V <sup>c</sup>	0.25	0.00	0
<b>Target Feed:</b>		<b>0.1</b>	<b>0.23</b>	<b>207</b>

Notes:

- a. The constituent feed rates for Phase III-3 were four times greater than the targeted feed rate.
- b. The Phase IV test had to be rerun (designated as Phase IV-R) due to a problem with the WSC feed.
- c. The Phase V test required high OBC and no WSC or S/T.

Generally, the OBC and S/T feed rate was slightly higher than targeted, and the WSC feed rate was slightly lower than targeted. The low WSC feed rate may be due in part to the clay occasionally clogging the tubing between the WSC decanter and the feed point. The low WSC feed rate was especially evident during the Phase IV test. There was difficulty maintaining the feed rate tolerances during Test Phase III-3, the test in which constituent feed rates increased by a factor of four.

#### 4.1.1 Theoretical TSS Concentration

As specified in Section 3.2.2, sediments (S/T and clay) were fed into the synthetic wastewater with mechanical pumps and dispensers. The sediment feed rates, along with the other

constituents, were carefully monitored during testing, and the weights of the constituents were recorded at the beginning and end of each test day. This monitoring program, in conjunction with the totalizer data from the influent flow monitor, allowed for a method of calculating the theoretical influent sediment (TSS) concentration separate from analytical methods. The theoretical TSS influent concentration was calculated for each test phase by using the S/T and WSC feed rates using the following equation:

$$\text{TSS}_{\text{theoretical}} = \text{S/T (mg/L)} + (93 \text{ mg/L} \times \% \text{ WSC}) \quad (4-1)$$

where :

$\text{TSS}_{\text{theoretical}}$  = Theoretical TSS concentration (mg/L)

S/T (mg/L) = Sand and topsoil constituent feed rate

93 mg/L = Target clay feed concentration

%WSC = Percent variance of actual WSC feed rate from target feed rate

This formula was used as a method of evaluating the TSS sample collection and laboratory test procedures as well as providing an additional method of ensuring the sediment feed rates were within the parameters established in the VTP.

#### 4.2 Synthetic Wastewater Laboratory Analytical Results

During testing, 45 influent samples were collected during the normal constituent feed conditions (Phase I, Phase I, Phase III-2, Phase IV-R) and analyzed for the various constituents specified in the VTP. Table 4-2 provides a comparison of the mean analytical results for these influent samples versus the analytical results for the synthetic wastewater mix specified in the VTP.

The mean synthetic wastewater data for the primary constituents were within the  $\pm 50$  percent guideline set forth in the protocol for the TPH, TSS, and COD samples. Furthermore, the correlation between TPH and O&G analyses remained consistent, although the indicator parameters TOC and COD were notably lower in the mean test samples as compared to the VTP samples.

The 400 mg/L mean TSS analytical concentration is considerably higher than the 300 mg/L VTP concentration, but still within the  $\pm 50$  percent guideline. The range of the TSS analytical concentrations for the influent samples was high, varying from 5 mg/L to 1,000 mg/L. Some TSS analytical data exhibited conditions exceeding QA/QC guidelines (see Chapter 5). Conversely, the mean theoretical TSS concentration (Equation. 4-1) was much lower than the corresponding analytical concentrations. Theoretical TSS concentrations had a mean of 295 mg/L and ranged from 240 mg/L to 396 mg/L. Therefore, although the mean analytical TSS concentration was higher than the 300 mg/L concentration specified in the VTP, the theoretical VTP concentration was very close to the 300 mg/L goal, and the overall objective for sediment loading concentrations was met.



**Table 4-2. Synthetic Wastewater Analytical Data Comparison**

Parameter	VTP Concentration (mg/L)	Mean Testing Concentration (mg/L)
<i>Targeted Constituent List:</i>		
TPH	42	48
TSS	300	400
COD	280	150
TOC	13	4.3
Benzene	0.002	0.003
Ethylbenzene	<0.001	0.005
Toluene	0.003	0.016
Total Xylenes	0.002	0.024
MTBE	<0.001	<0.001
<i>Additional Constituent List:</i>		
Oil & Grease	52	62
Metals	2	5
<i>Secondary Constituents:</i>		
Total Phenols	0.003	0.002
Surfactants (MBAS)	12	2.1
PO <sub>4</sub> -P	1	0.53
TKN	3	1.2
NH <sub>3</sub> -N	0.2	0.5

Note: The detection limit was used for calculating the mean testing concentration for data when the reported result was below detection limits.

The variances between the VTP and mean testing concentrations for the secondary parameters exceeded the ±50 percent guideline for most parameters, but the vendor makes no claims for the secondary parameters, and, in most cases, the synthetic wastewater constituents had the secondary constituents only at background concentrations. Therefore, the variation from the targeted concentrations is deemed to have no impact on meeting the testing objectives.

**4.2.1 BTEX/MTBE and TOC Analysis Issue**

During testing, the TO made an important observation regarding to the BTEX, MTBE, and TOC analyses. A comparison of the BTEX, MTBE, and TOC data showed no appreciable constituent reduction between influent and effluent samples, even though other hydrocarbon analytical data (especially TPH and O&G) from the same samples showed an appreciable constituent reduction between influent and effluent samples.

An investigation conducted by the TO identified the root cause of this issue to be related to the procedures outlined in the analytical method. BTEX, MTBE, and TOC samples were collected into 40 mL vials. The laboratory analytical procedure included drawing a 10-15 mL aliquot from the center of the vial with a syringe attached to an auto-sampling device in accordance with EPA-approved procedures. During sample collection, TO personnel noted that the hydrocarbon fraction tended to separate quickly and float on top of the water in the sample vials. The syringe

on the auto-sampling device, which draws the sample from the center of the vial, would not draw in the hydrocarbons floating on the top of the sample. Instead, the syringe would only draw a sample of the water with dissolved-phase hydrocarbons.

Based on this observation, the TO concluded that the BTEX, MTBE, and TOC data could not be relied upon to accurately represent the performance of the Hydro-Kleen™ system. The data is still available in the report appendices (Appendix B) but will not be referenced in the subsequent sections of this Verification Report.

### **4.3 Test Phases in VTP**

This section summarizes the analytical and flow data for the test phases specified in the VTP (Phases I through IV). The efficiency values reported in this section are a function of the total influent and treated effluent concentrations and do not take into account the effects of water bypassing the filter media.

#### **4.3.1 Phase I - Performance under Intermittent Flow Conditions**

As described in Section 3.5.1, the Phase I test took place over five consecutive days, eight hours per test day, with the flow alternating on and off for 15-minute time periods. The influent flow rate was set at 15 gpm throughout the test. The test was performed from Monday, February 17 to Friday, February 21, 2003.

##### **4.3.1.1 Analytical Data**

The TPH, O&G, COD, and TSS analytical data are summarized in Table 4.3. Most of the analytical data dedicated to hydrocarbon detection (TPH and O&G) show the Hydro-Kleen™ unit removed hydrocarbons in the treated effluent at a range of 70 to 90 percent. The hydrocarbon removal efficiencies did not decline over the course of the five-day test, which indicates that hydrocarbon breakthrough did not occur. The COD analytical data showed a change in the treated effluent with a much wider range (-30 to 72 percent) than either the TPH or O&G data. This may indicate the COD test, which was used as an indicator parameter for the presence of organic compounds, may not be a reliable test for this program.

On the third day of the five-day test, the TPH, O&G, and COD data show the influent hydrocarbon concentrations were 50 to 85 percent lower than the mean influent concentrations on the other four days. A review of the hydrocarbon feed data in Table 4-1 shows the OBC feed rate (0.11 mL/L) was slightly lower on the third day than on the other four days (0.12 mL/L each day). The corresponding effluent analytical data does not reveal an equivalent reduction, with no noticeable difference in effluent analytical concentrations on the third day as compared to the other four days. Subsequently, the third-day results show lower calculated removal efficiencies when compared with the other four days. These influent feed concentrations may be outliers rather than an indication of performance of the Hydro-Kleen™ system.

**Table 4-3. Phase I Analytical Data Summary**

<b>Analytical Test</b>	<b>Test Day (Sample Type)</b>	<b>Influent Concentration (mg/L)</b>	<b>Treated Effluent Concentration (mg/L)</b>	<b>Efficiency (Percent)</b>
TPH	1 (Grab)	87.8	22.3	75
	1 (Composite)	85.6	<10	88
	2 (Grab)	63.2	<10	84
	3 (Grab)	<10	<10	0
	3 (Dup.)	13.9	13.7	1
	3 (Composite)	33.8	<10	70
	3 (Dup. Composite)	20.2	13.7	32
	4 (Grab)	23.2	<10	78
	5 (Grab)	63.4	12.1	81
O&G	1 (Grab)	126	27.1	79
	2 (Grab)	76.8	7.7	90
	3 (Grab)	7.8	5.5	30
	3 (Dup. Grab)	13.9	16.6	-19
	4 (Grab)	27.7	6.7	76
	5 (Grab)	79.5	14	82
COD	1 (Avg. Composite)	310	87	72
	2 (Composite)	140	140	0
	3 (Avg. Composite)	91	99	-9
	4 (Composite)	200	60	70
	5 (Composite)	100	130	-30
TSS	1 (Avg. Composite)	550	80	85
	2 (Grab)	460	40	91
	3 (Avg. Composite)	620	69	90
	4 (Grab)	310	150	52
	5 (Grab)	300	73	76

The solids (TSS) analytical data showed a reduction in the treated effluent in a range of 52 to 91 percent. The daily influent grab (Days 2, 4, and 5) and composite (Days 1 and 3) TSS analytical concentrations ranged from 300 mg/L to 620 mg/L, and equaled or exceeded the 300 mg/L target influent concentration for each of the five test days. A comparison of the composites collected during Days 1 and 3 and the grab samples collected during Days 2, 4, and 5 did not yield significantly different results. This would indicate that either grab or composite samples could be used to evaluate the performance of the system.

The secondary constituents (phosphorus, TKN, ammonia, surfactants, and phenol) and metals showed no reduction in the treated effluent. However, the vendor makes no removal claims for the secondary constituents, and the synthetic wastewater did not include substances that would result in elevated nutrients or phenol concentrations. The vendor only makes claims for organically bound metals, such as metals that may be present in used oil. The metals in the

synthetic wastewater were not organically bound, and the results are consistent with the vendor's claims.

#### 4.3.1.2 Flow Data

During testing, real-time influent and effluent flow rates for each testing period were monitored using the flow monitors or the catch-and-weigh technique outlined in Section 3.2.1.1. The mean influent and effluent flow for the 15-minute testing periods were calculated by dividing the totalizer volume by the time period, or by multiplying the catch-and-weigh calculated flow rate by the time period. This flow data was noted on the bench sheet and maintained in a spreadsheet. The flow data is presented graphically in Figure 4-1 and in tabular form in Table 4-4.

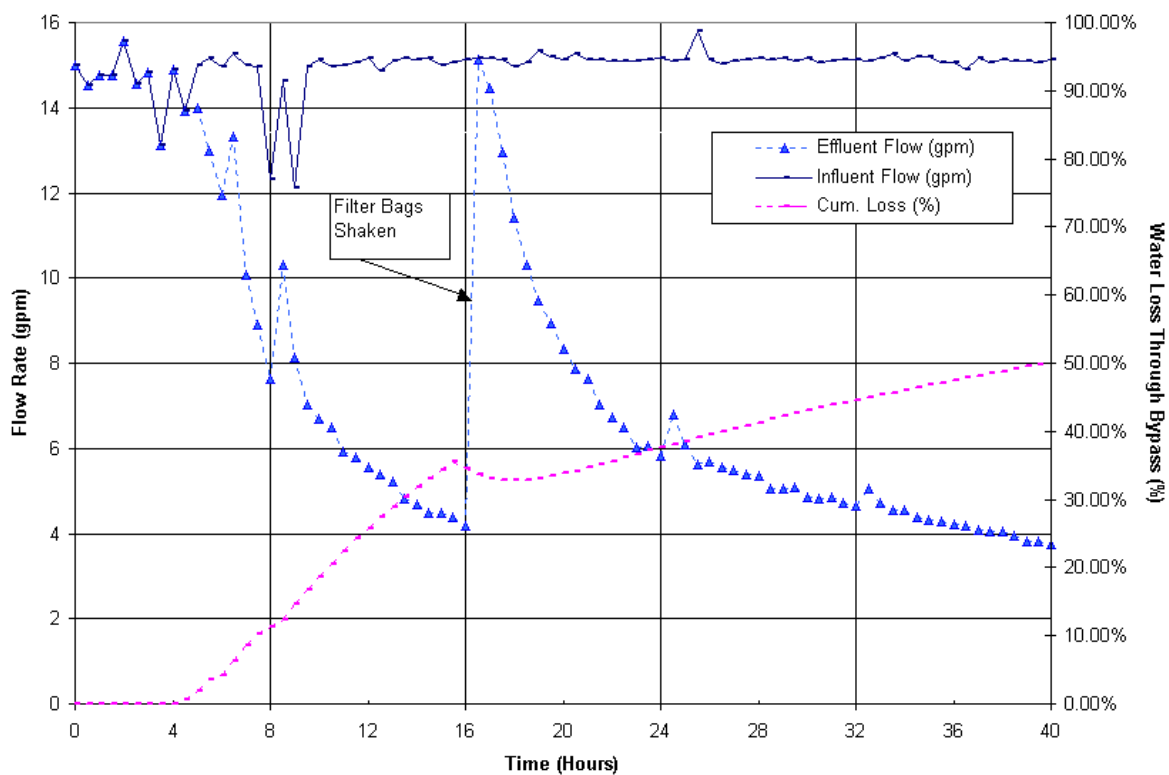

**Figure 4-1. Phase I influent vs. treated effluent flow rates and cumulative loss.**

The treated effluent flow rate mirrored the influent flow rate for the first five hours of testing, but then started dropping as the filter media began to blind off and a portion of the effluent was lost through the bypass holes. At the end of the 16<sup>th</sup> hour (second day), the TO, with approval from the vendor, performed maintenance on the filter media in accordance with the vendor's O&M procedures to attempt to improve flow. The filter bags were removed from the system, shaken, and placed back into the system. The maintenance helped briefly; at the beginning of the third

**Table 4-4. Phase I Flow Data Summary**

Hour	Influent Flow (gpm)	Effluent Flow (gpm)	Cumulative Influent (gal)	Cumulative Effluent (gal)	Cum. Loss (Pct.)	Hour	Influent Flow (gpm)	Effluent Flow (gpm)	Cumulative Influent (gal)	Cumulative Effluent (gal)	Cum. Loss (Pct.)
0.5	14.5	14.5	218	218	0	20.5	15.3	7.9	9,113	6,034	34
1	14.7	14.7	439	439	0	21	15.1	7.6	9,340	6,149	34
1.5	14.7	14.7	660	660	0	21.5	15.1	7.0	9,567	6,254	35
2	15.6	15.6	894	894	0	22	15.1	6.7	9,794	6,355	35
2.5	14.6	14.6	1,112	1,112	0	22.5	15.1	6.5	10,020	6,452	36
3	14.8	14.8	1,334	1,334	0	23	15.1	6.0	10,247	6,543	36
3.5	13.1	13.1	1,531	1,531	0	23.5	15.1	6.1	10,474	6,634	37
4	14.9	14.9	1,755	1,755	0	24	15.2	5.8	10,701	6,721	37
4.5	13.9	13.9	1,964	1,964	0	24.5	15.1	6.8	10,928	6,823	38
5	15.0	14.0	2,188	2,174	1	25	15.1	6.1	11,155	6,914	38
5.5	15.2	13.0	2,416	2,369	2	25.5	15.8	5.6	11,392	6,998	39
6	14.9	12.0	2,640	2,548	3	26	15.1	5.7	11,619	7,083	39
6.5	15.3	13.3	2,869	2,748	4	26.5	15.0	5.6	11,844	7,167	39
7	15.0	10.1	3,094	2,898	6	27	15.1	5.5	12,071	7,249	40
7.5	15.0	8.9	3,319	3,032	9	27.5	15.1	5.4	12,297	7,330	40
8	12.3	7.6	3,504	3,146	10	28	15.2	5.4	12,525	7,410	41
8.5	14.6	10.3	3,723	3,301	11	28.5	15.1	5.1	12,752	7,486	41
9	12.1	8.1	3,905	3,423	12	29	15.2	5.1	12,980	7,562	42
9.5	15.0	7.0	4,129	3,529	15	29.5	15.1	5.1	13,206	7,638	42
10	15.1	6.7	4,356	3,629	17	30	15.2	4.8	13,434	7,711	43
10.5	15.0	6.5	4,580	3,726	19	30.5	15.1	4.8	13,659	7,783	43
11	15.0	5.9	4,805	3,815	21	31	15.1	4.9	13,886	7,856	43
11.5	15.1	5.8	5,031	3,902	22	31.5	15.1	4.7	14,113	7,927	44
12	15.2	5.6	5,259	3,985	24	32	15.1	4.7	14,340	7,997	44
12.5	14.9	5.4	5,481	4,066	26	32.5	15.1	5.1	14,566	8,073	45
13	15.1	5.2	5,708	4,145	27	33	15.2	4.7	14,794	8,144	45
13.5	15.2	4.8	5,935	4,217	29	33.5	15.3	4.6	15,023	8,212	45
14	15.1	4.7	6,162	4,287	30	34	15.1	4.6	15,249	8,281	46
14.5	15.2	4.5	6,390	4,354	32	34.5	15.2	4.4	15,477	8,347	46
15	15.0	4.5	6,614	4,422	33	35	15.2	4.3	15,705	8,412	46
15.5	15.1	4.4	6,840	4,487	34	35.5	15.0	4.3	15,931	8,476	47
16	15.1	4.2	7,068	4,550	36	36	15.1	4.2	16,156	8,539	47
16.5	15.2	15.1	7,295	4,777	35	36.5	14.9	4.2	16,380	8,602	47
17	15.2	14.5	7,522	4,994	34	37	15.2	4.1	16,608	8,663	48
17.5	15.1	13.0	7,749	5,189	33	37.5	15.1	4.1	16,834	8,724	48
18	15.0	11.4	7,974	5,360	33	38	15.1	4.1	17,061	8,785	49
18.5	15.1	10.3	8,200	5,515	33	38.5	15.1	4.0	17,287	8,844	49
19	15.3	9.5	8,430	5,657	33	39	15.1	3.8	17,514	8,902	49
19.5	15.2	8.9	8,658	5,791	33	39.5	15.1	3.8	17,740	8,959	49
20	15.1	8.3	8,885	5,916	33	40	15.1	3.7	17,967	9,015	50

day of testing, the treated effluent flow recovered to the 15 gpm influent flow rate, but soon dropped off again. In addition, the flow rate through the filter media bags recovered slightly during the 16-hour overnight period in which the testing rig was not run. By the end of the five-day testing period, the treated effluent flow rate had diminished to less than four gpm, and approximately 50 percent of the total volume of water that had entered the system during the Phase I test had passed through the bypass holes instead of passing through the filter media.

The Hydro-Kleen™ system's design prevents water bypassing the system from undergoing treatment, with the possible exception of the heaviest sediments settling in the sediment chamber. For this reason, one can make the assumption that the synthetic wastewater bypassing the system has approximately the same constituent concentrations as the influent. In an actual catch basin, the treated effluent water would remix with the untreated bypass water. Therefore, to calculate a constituent removal efficiency of the system at a given time interval, the constituent removal efficiencies noted in Section 4.3.1.1 would have to be reduced by the percentage of influent bypassing the system.

#### **4.3.2 Phase II – Determination of the Capacity of the Unit**

As described in Section 3.5.2, in Phase II the system was run to “exhaustion” with respect to the capacity of the sorbent material to remove suspended solids or petroleum hydrocarbons. The unit was operated under continuous flow conditions at a constant flow rate of 18 gpm until the unit plugged with solids or the contaminant absorption capacity was exceeded. The VTP specified a flow rate of 40 gpm for this test, based on the vendor's claims that the system could treat water at a maximum flow rate of approximately 50 gpm. Phase III, which was completed prior to the start of Phase II, identified the maximum flow rate to be 23 gpm. Therefore, the TO adjusted the flow rate for this test, as outlined in the protocol, to 80 percent of the maximum flow.

##### **4.3.2.1 Analytical Data**

As specified in the VTP, complete sets of samples were collected at the start and end of the test. In addition, one intermittent set of samples were collected for COD and TSS analysis, as summarized in Table 4-5.

In general, the Hydro-Kleen™ system was 54 to 82 percent effective in removing hydrocarbons from the treated effluent, based on a review of the TPH and O&G data. Furthermore, the hydrocarbon efficiency did not diminish at the end of the test, indicating that hydrocarbon capacity of the filter media had not been exceeded. A review of the COD data shows a 31 to 34 percent removal efficiency at startup, and an 83 to 85 percent removal efficiency at the end of the test.

In three of the four influent TSS samples, the analytical concentration was 15 mg/L, 20 mg/L, and 72 mg/L, all well below the 300 mg/L target. A review of the feed rates in Table 4-1 shows the S/T and WSC/clay feed rates (-15 percent and -31 percent, respectively) were less than the target feed rates but were within the allowable  $\pm 50$  percent feed interval. The effluent TSS concentrations ranged from 8 mg/L to 80 mg/L, with the highest concentrations occurring at the start of the test and the lowest concentrations at the end.

**Table 4-5. Phase II Analytical Data Summary**

Analytical Test	Description	Influent Concentration (mg/L)	Treated Effluent Concentration (mg/L)	Efficiency (Percent)
TPH	Startup	63.6	11.3	82
	Startup (Dup.)	46.6	12.1	74
	7,000-Gal.	42.6	19.4	55
O&G	Startup	63.9	13.9	78
	Startup (Dup.)	68.9	17.2	75
	7,000-Gal.	64.5	19.4	70
COD	Startup	122	81	34
	Startup (Dup.)	100	69	31
	5,500-Gal.	133	19	85
	7,000-Gal.	130	22	83
TSS	Startup	485	72	85
	Startup (Dup.)	72	80	-11
	5,500-Gal.	15	22	-47
	7,000-Gal.	20	8	60

Similar to Phase I, the secondary constituents (phosphorus, TKN, ammonia, surfactants, and phenol) and metals showed no reduction in the treated effluent. As explained in Section 4.3.1.1, these findings are consistent with the vendor’s claims.

4.3.2.2 Flow Data

During testing, real-time influent and effluent flow rates for each testing period were monitored using the flow monitors and the catch-and-weigh technique outlined in Section 3.2.1.1. Flow data were noted on the bench sheet and maintained in a spreadsheet. The flow data are presented in Table 4-6.

The system was able to treat all the influent for approximately the first 80 minutes of the test, but then the filter media began blinding off and bypassing. The protocol indicated the test could be completed once bypass was observed. The test was stopped after 7,410 gallons of influent had entered the system, and it was evident that continued testing would result in a further restriction in treated effluent flow.

**4.3.3 Phase III – Performance under Varied Hydraulic and Concentration Conditions**

As described in Section 3.5.3, Phase III testing focused on determining the unit’s hydraulic flow capacity and how well it handles spike loads of constituents. Phase III had three distinct parts:

- Part 1: Hydraulic capacity with clean water;
- Part 2: Hydraulic capacity with synthetic wastewater (regular constituent feed concentrations);
- Part 3: Hydraulic capacity with spiked constituents (four times constituent feed concentrations).

**Table 4-6. Phase II Influent and Effluent Flow Summary**

<b>Test Time (Minutes)</b>	<b>Influent Totalizer (gal)</b>	<b>Influent Flow (gpm)</b>	<b>Effluent Flow (gpm)</b>	<b>Bypass (Percent)</b>
0	0	18.0	18.6	0
35	625	17.8	17.9	0
65	1,170	18.2	18.8	0
86	1,550	18.2	18.0	1
120	2,150	18.0	16.1	11
135	2,420	18.0	15.4	14
155	2,780	18.0	14.7	18
180	3,230	18.0	14.5	20
200	3,585	18.0	14.1	22
230	4,120	18.0	13.1	28
250	4,475	18.0	12.7	29
270	4,830	18.0	12.1	33
310	5,540	18.0	11.8	35
340	6,075	17.8	11.2	37
370	6,610	18.0	10.8	40
396	7,075	18.0	10.4	43
415	7,410	18.0	10.1	44

The Phase III tests were performed first because the information gathered in Phase III would help set the flow rates in Phases II and IV.

4.3.3.1 Flow Data

In Phase III-1, clean water was used to determine the maximum hydraulic capacity of the system before water bypassed the unit and whether drain backup would occur, resulting in potential flooding of the catch basin. The test started at 20 gpm and ran for a minimum of 15 minutes. The flow rate was then increased at 10 gpm increments, and the test was rerun until bypass occurred. Test Phases III-2 and III-3 were identical to Phase III-1, with the exception that constituents were added to the clean water.

The flow data are summarized in Table 4-7 and is shown graphically in Figure 4-2. The data show the Hydro-Kleen™ system is capable of a throughput of approximately 30 gpm with clean water, after which the flow capacity is maximized and flow exits through the bypass holes. During Phase III-2, the maximum treated throughput rate dropped to 22.7 gpm, and stabilized as influent flow rates increased. During Phase III-3, the treated effluent throughput started at 12 gpm for the 20 gpm influent flow rate and dropped rapidly to a minimum flow of 3 gpm at 50 gpm influent flow. The VTP did not provide for cleaning the system during or between tests, so the system and filter media capacity was diminished by the constituents from each previous test occurrence.



**Table 4-7. Phase III Influent and Effluent Flow Summary**

Influent Flow (gpm)	Effluent Flow		
	Phase III-1	Phase III-2	Phase III-3
20	17.1	17.2	12.0
30	29.1	22.3	6.5
40	30.2	22.7	5.0
50	30.5	18.9	3.0
60	29.7	N/A	N/A
135	32.8	N/A	N/A

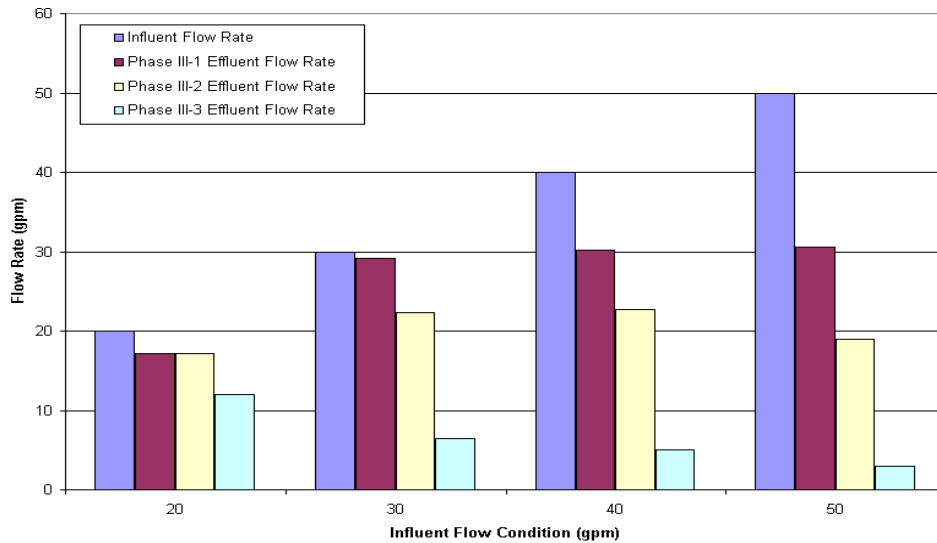

**Figure 4-2. Phase III influent and effluent flow bar chart.**

4.3.3.2 Analytical Data

Samples were collected during Phase III-2 and Phase III-3 testing at the 20 gpm, 30 gpm, 40 gpm and maximum flow (50 gpm) intervals. The analytical data are summarized in Table 4-8. For both Phase III-2 and III-3, the TPH and O&G data show a reduction in the treated effluent ranging from 64 to 96 percent, and the hydrocarbon reduction did not diminish over time, which would indicate that hydrocarbon capacity of the filter media had not been exceeded. The COD analytical data showed a reduction in the treated effluent with a much wider range (-53 to 80 percent) than either the TPH or O&G data. This may indicate that the COD test, which is an indicator parameter for the presence of organic compounds, may not be a reliable test for this program. The TSS analytical data also showed a reduction ranging from 53 to 100 percent in the treated effluent.

**Table 4-8. Phase III Analytical Data Summary**

Analytical Test	Test Phase	Flow Rate (gpm)	Influent Concentration (mg/L)	Effluent Concentration (mg/L)	Efficiency (Percent)
TPH	III-2	20	48.6	<10	90
	III-2	20 (Dup.)	75.1	<10	93
	III-2	50	63.3	<10	92
	III-3	20	125	44.4	65
	III-3	50	202	10.3	95
O&G	III-2	20	60.7	10.4	83
	III-2	20 (Dup.)	94.2	8.2	91
	III-2	50	77.3	12.1	84
	III-3	20	226	55.8	75
	III-3	50	457	12.9	97
COD	III-2	20	100	73	27
	III-2	20 (Dup.)	58	89	-53
	III-2	30	120	75	38
	III-2	40	60	48	20
	III-2	50	34	26	24
	III-3	20	800	380	53
	III-3	30	280	150	46
	III-3	40	320	89	72
	III-3	50	330	65	80
TSS	III-2	20	220	58	74
	III-2	20 (Dup.)	400	52	87
	III-2	30	240	68	72
	III-2	40	68	32	53
	III-2	50	5	8	-60
	III-3	20	630	180	71
	III-3	30	1,600	30	98
	III-3	40	1,600	150	91
	III-3	50	2,100	<2	100

**4.3.4 Phase IV– Contaminant Capacities at High Hydraulic Throughput**

As described in Section 3.5.4, in Phase IV the system was run to hydrocarbon capacity or solids exhaustion (similar to Phase II), except that the unit was under higher hydraulic loads typical of a very large flow event.

The unit was operated under continuous flow conditions at a constant flow rate of 42 gpm until the unit plugged with solids, or the contaminant absorption capacity was exceeded. The VTP specified a flow rate of 80 gpm, based on the vendor’s claims that the system could treat water at a maximum flow of approximately 50 gpm. Phase III identified a maximum flow rate of

23 gpm, so the flow rate for this test was run at approximately 42 gpm, as specified in the protocol to be 85 percent greater than the maximum flow.

During the first day, the TO observed the WSC feed system frequently plugged with clay, which prevented the WSC and clay from mixing with the synthetic wastewater. Based on this observation, the test was stopped and modifications and repairs were made to the WSC. The Hydro-Kleen™ system and test rig were cleaned, and the test was rerun the following day. During the second day, there were no problems with the WSC feeder.

#### 4.3.4.1 Analytical Data

As specified in the VTP, complete sets of samples were collected at the start and end of the Phase IV test. In addition, one intermittent set of samples were collected for COD and TSS analysis after 10,000 gallons of influent had been run. The Phase IV test was run twice, and two complete sets of samples were collected for analysis. However, the TPH, O&G, and BTEX/MTBE analyses were not run on the first set of startup samples because the first Phase IV test was invalidated. In order to differentiate between the two sets of Phase IV samples, the samples collected on the second day were named “Phase IV-R” (as in Ph-IV-R-Startup-Inf). The analytical data are summarized in Table 4-9.

**Table 4-9. Phase IV-R Analytical Summary**

Analytical Test	Description	Influent Concentration (mg/L)	Effluent Concentration (mg/L)	Efficiency (Percent)
TPH	Startup	34.8	11.9	66
	12,500 gal	39.6	18.5	53
O&G	Startup	76.8	17.0	78
	12,500 gal	62.1	15.8	75
COD	Startup	85	97	-14
	10,000 gal	130	90	31
	12,500 gal	92	85	8
TSS	Startup	65	70	-8
	10,000 gal	78	55	30
	12,500 gal	35	40	-14

In general, the Hydro-Kleen™ system was 53 to 78 percent effective at removing hydrocarbons from the treated effluent, based on a review of the TPH and O&G data. Furthermore, the hydrocarbon efficiency did not diminish substantially at the end of the test, indicating that hydrocarbon capacity of the filter media had not been exceeded. The TPH and O&G data do not correlate with the COD data, which show the system to be -14 percent efficient at startup, 31 percent efficient at 10,000 gallons, and 8 percent efficient at the end of the test.

In each of the three influent TSS samples, the analytical concentrations were substantially below the 300 mg/L target concentration (65 mg/L, 78 mg/L, and 35 mg/L). A review of the feed rates

in Table 4-1 shows the S/T and WSC/clay feed rates (-6 percent and -35 percent, respectively) were less than the target feed rates, but within the allowable  $\pm 50$  percent feed interval. The S/T, WSC/clay, and influent water feed rates yield a theoretical TSS concentration of 254 mg/L. The treated effluent TSS concentrations ranged from 40 mg/L to 70 mg/L, with the highest concentrations occurring at the start of the test and the lowest concentrations at the end.

Similar to the Phase I test results, the treated effluent showed no reduction of secondary constituent (phosphorus, TKN, ammonia, surfactants, and phenol) and metal concentrations. These findings are consistent with the vendor's claims, as discussed in Section 4.3.1.1.

#### 4.3.4.2 Flow Data

During testing, real-time influent and effluent flow rates for each testing period were monitored using the flow monitors and the catch-and-weigh technique outlined in Section 3.2.1.1. Flow data were noted on the bench sheet and maintained in a spreadsheet. The flow data for Phase IV-R are presented in Table 4-10.

The flow rates at the start of the Phase IV test exceeded the maximum flow capacity established in Test Phase III-2, but dropped fairly rapidly as the filter media filled with constituents and began blinding off.

#### 4.3.5 Phases I-IV Data Summary and Discussion

The flow and analytical data in the four test phases provided the following general observations:

- The Hydro-Kleen™ unit removed petroleum hydrocarbons from the challenge water. Based on efficiencies using 17 sets of TPH and 15 sets of O&G influent and effluent samples, the hydrocarbon treatment efficiency is presented in Table 4-11.
- The TOC and BTEX/MTBE analytical data were omitted from performance considerations because the analytical method was unable to properly extract a sample aliquot due to the presence of free product in the samples. The analytical method and equipment cannot properly analyze a sample with free product.
- The TSS influent analytical data showed a high degree of variance. The theoretical TSS concentration is likely a more reliable indicator of the sediment concentration in the influent. Also, TSS analytical concentrations tended to decrease as the influent flow rate increased. Table 4-12 summarizes the mean TSS analytical and theoretical concentrations and the degree of variance. This condition was anticipated for two primary reasons. First, the S/T do not mix homogeneously in the water, making it possible for uniform flow and feed conditions to result in an uneven distribution of S/T in the water. This was minimized by thoroughly mixing the influent and making the distance between the S/T dispensing location and the influent sample collection location as long as practical. Second, the TSS samples were collected into small (40 mL) containers. The TSS analysis consists of passing the entire sample through filter paper and comparing the mass of the filter paper before and after pouring the sample off. The laboratory specifically required a small sample container because larger sample volumes could blind off the filter paper prior to pouring off the entire sample.

**Table 4-10. Phase IV-R Flow Data Summary**

<b>Time (Minutes)</b>	<b>Influent Totalizer (gal)</b>	<b>Influent Flow (gpm)</b>	<b>Treated Effluent Flow (gpm)</b>	<b>Bypass (Percent)</b>
0	0	42	38.0	10
17	705	42	34.2	19
43	1,775	42	28.0	33
71	2,930	42	22.4	47
80	3,420	42	22.4	47
97	3,420	42	24.8	41
105	3,580	42	26.2	38
118	4,140	42	24.0	43
130	4,650	42	22.7	46
148	5,410	42	20.9	50
170	6,345	42	19.7	53
181	6,810	42	18.6	56
210	8,030	42	16.6	60
226	8,710	42	15.9	62
240	9,295	42	15.0	64
256	9,970	42	14.2	66
268	10,475	42	13.6	68
285	11,190	42	13.1	69
301	11,860	42	12.8	70
326	12,490	42	12.7	70

**Table 4-11. TPH and O&G Treatment Efficiency Summary**

<b>Statistic</b>	<b>TPH (Percent)</b>	<b>O&amp;G (Percent)</b>
Mean	77	78
Median	81	78
Maximum	95	97
Minimum	32	30
Standard Deviation	0.2	0.2

**Table 4-12. Comparison of Mean Analytical and Theoretical Influent TSS Concentrations**

<b>Phase</b>	<b>Mean TSS Analytical Concentration</b>	<b>Mean TSS Theoretical Concentration</b>	<b>Variance (Percent)</b>
I	553	330	68
II	149	240	-38
III-2	187	249	-25
III-3	1480	1320	12
IV-R	59	254	-77

- The metals data indicate the Hydro-Kleen™ system was not effective at treating the low concentrations of metals in the synthetic wastewater. The vendor claims to be able to remove only organically bound metals, such as metals present in used oil. It should be noted that the synthetic wastewater did not contain a constituent with organically bound metals or nutrients, and in many cases, the metals data were near or below the laboratory detection limits. Using data points at or below laboratory detection limits to calculate removal efficiencies can result in misleading data.
- The nutrient and surfactant data showed the Hydro-Kleen™ system was not effective at removing these constituents from the synthetic wastewater mixture. This observation is consistent with the vendor's claims.
- During each test phase, the Hydro-Kleen™ filter media blinded off before testing was completed and before hydrocarbon breakthrough (as noted by elevated TPH or O&G effluent analytical concentrations) was observed. This observation posed two concerns. First, a primary consideration for the effectiveness of hydrocarbon control BMP devices is to determine the hydrocarbon capacity of the filter media. Because the filter media physically blinded off before hydrocarbon capacity had been reached, this determination could not be made. Second, it was possible that the synthetic wastewater constituents, and in particular the composition and concentration of the S/T and clay, posed an unfair challenge for in-drain treatment devices.
- An evaluation of the theoretical TSS mass in the influent versus the percentage of influent water lost to bypass during test Phases I, II, IV, and IV-R showed the rate at which the filter media was blinding off was similar, as shown graphically in Figure 4-3. These four tests were each conducted with an theoretical TSS concentration goal of 300 mg/L, with the primary difference being the influent flow rate (gpm). The TO hypothesized that a similar condition could occur with a decreased theoretical TSS influent concentration, making it possible to estimate the rate of blinding off as a function of the mass, and not necessarily the concentration, of TSS in the influent.

Based on these findings, particularly the issues of blinding off and hydrocarbon breakthrough, the vendor and TO agreed to conduct two additional tests not specified in the protocol. The first test removed the WSC and S/T constituents from the synthetic wastewater, leaving only the OBC constituent, to determine the hydrocarbon capacity of the filter media. The second test repeated the Phase II test but reduced the S/T feed and the clay concentration in the WSC/clay mixture by approximately 50 percent. This test was conducted to test the hypothesis that the rate of media blinding off was a function of the mass, and not the concentration, of sediments in the influent.

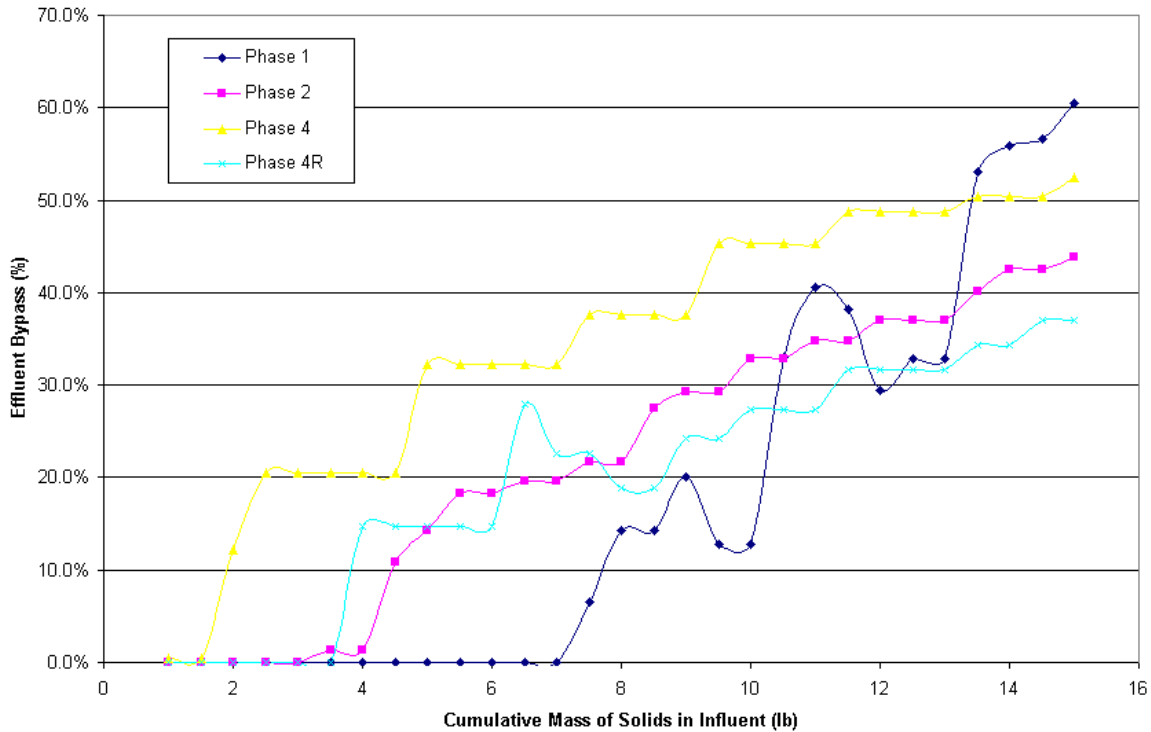

**Figure 4-3. Theoretical TSS mass vs. bypass--Phases I, II, IV, and IV-R.**

#### 4.4 Additional Test Phases

##### 4.4.1 Hydrocarbon Capacity Test (Phase V)

As described in Section 3.6.1, the Phase V test was designed to determine the hydrocarbon capacity of the filter media without the presence of the WSC and sediments in the synthetic wastewater. The hydrocarbon constituent concentration was increased to approximately 2.5 times the concentration used for the other test phases. The influent flow rate was set at a constant 18 gpm, and the test was performed on a continuous basis, until evidence of hydrocarbons in the effluent was observed and hydrocarbon removal had decreased to less than 35%. The density of the hydrocarbon stock solution was measured at 803 mg/mL. Based on the measured volume of stock solution fed during the capacity test, the concentration of hydrocarbons in the influent was approximately 217 mg/L. These data were used to calculate the mass of hydrocarbon in the influent water fed to the filter media.

##### 4.4.1.1 Flow Data

A total of approximately 7,600 gallons of synthetic wastewater flowed through the unit during the one-day test. No bypass conditions were observed.

4.4.1.2 Analytical Data

Influent and effluent samples were collected at the beginning (within the first 100 gallons of applied water) and end of the test, and analyzed for TPH, O&G, TOC, and BTEX/MTBE. Effluent samples were analyzed for O&G, TPH, and TOC, after 2,500 and 5,000 gal of water had passed through the unit. The laboratory data for the O&G and TPH analyses are summarized in Table 4-13 and presented graphically in Figure 4-4.

**Table 4-13. Phase V Analytical Data Summary**

Influent Volume (gal)	Influent Mass of HC <sup>(1)</sup> (lb)	Influent O&G (mg/L)	Influent TPH (mg/L)	Effluent O&G (mg/L)	Effluent TPH (mg/L)	O&G Reduction (Percent)	TPH Reduction <sup>(2)</sup> (Percent)
0	0	171	126	28.2	22.4	84	82
2,500	4.54	<i>173<sup>(3)</sup></i>	<i>135</i>	93.0	76.3	46	44
5,000	9.08	<i>173</i>	<i>135</i>	98.4	80.6	43	40
7,500	13.6	175	144	137	101	22	30

- Note: <sup>(1)</sup> Mass of HC in influent calculated based on the actual mass of HC fed from stock solution tank.  
<sup>(2)</sup> Based on influent and effluent concentrations.  
<sup>(3)</sup> The influent analytical results shown in *italics* are mean concentrations based on the samples analyzed at the beginning and end of the test.

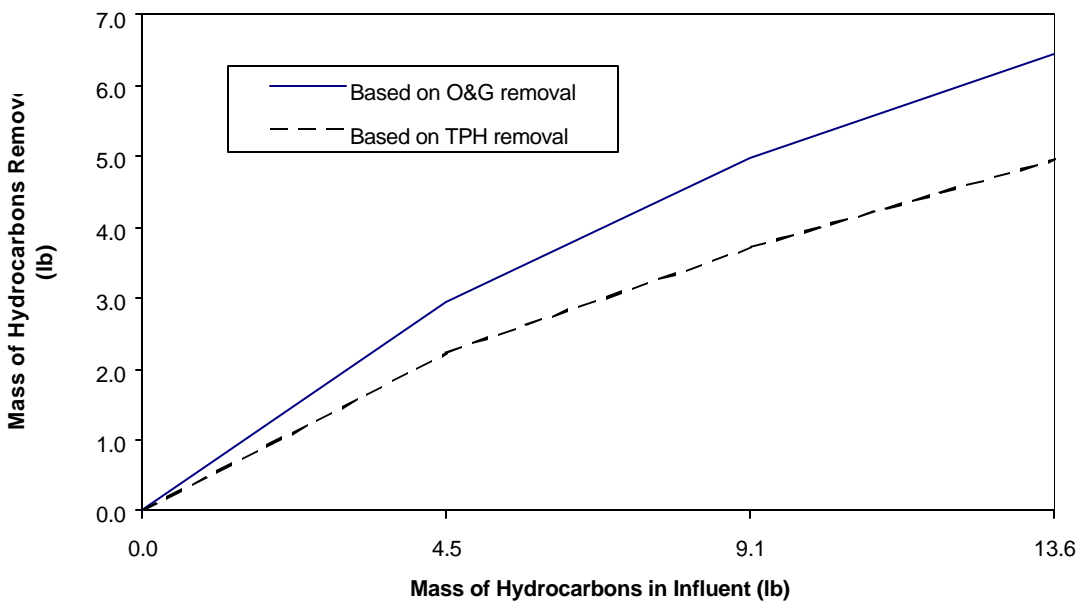

**Figure 4-4. Phase V mass of hydrocarbon removed vs. mass fed.**



The laboratory analytical data showed an 82 percent reduction in TPH concentrations and an 84 percent reduction in O&G concentrations at startup. At the next two sampling intervals (2,500 gallons and 5,000 gallons), the laboratory analytical data showed hydrocarbon removal ranging from 40 to 46 percent. At the 7,500-gallon testing interval, a strong visual presence of hydrocarbon breakthrough in the effluent (identified by observation of an oil sheen on the surface and presence of hydrocarbon odor) was noted, and the test was stopped. At this interval, the O&G analysis showed a 22 percent hydrocarbon reduction, and the TPH analysis showed a 30 percent hydrocarbon reduction.

The hydrocarbon reduction capability of the unit can be expressed as a mass of hydrocarbons removed, based on either O&G or TPH data. The O&G removal efficiency data was used in conjunction with the measured mass of HC fed to the unit to determine the pounds of HC removed and the capacity of the unit. The data shown in Figure 4-4, based on O&G data, is calculated by multiplying the mean O&G removal efficiency for each monitoring interval times the mass of hydrocarbon fed to the unit. The TPH data is calculated in a similar manner, except that the TPH concentrations had a mean of 78 percent of the O&G concentration. Therefore, the mass of hydrocarbons fed to the unit was adjusted by this factor to calculate the mass of TPH in the influent. The filter media capacity was calculated to be approximately 6.4 pounds of HC based on O&G, and 5.0 pounds based on TPH.

The data can also be used to estimate the volume of oil and grease (on a pure HC solution basis) that can be retained by the filter media. Using the density of the hydrocarbon constituent of 803 grams per liter (6.69 lb/gal), the filter media breakthrough capacity was calculated to be approximately 1.0 gal of HC as measured by O&G.

#### **4.4.2 Reduced Constituent Concentrations Tests**

As described in Section 3.6.2, the Reduced Constituent Concentrations tests were performed with lower TSS concentrations to determine if the TSS concentration established in the protocol and VTP had a significant impact on the Hydro-Kleen™ system, and to evaluate whether bypass could be expressed as a function of the mass, and not the concentration, of sediments in the influent.

##### **4.4.2.1 Procedures, Flow Data and Discussion**

The reduced constituent tests were run at a constant influent flow rate of 18 gpm. The S/T feeder was set to the lowest possible setting, and the clay concentration in the WSC was reduced to be proportional to the S/T feed rate.

Similar to the Phase II testing, the influent and treated effluent flow rates were periodically monitored and recorded on bench sheets. At the end of the day, the constituent containers were weighed to determine the mass of constituents added to the synthetic wastewater. These measurements indicated the theoretical TSS concentration was 239 mg/L, which was not substantially different from the other test phases. For this reason, this test was invalidated and stopped.

The TO performed an evaluation of the S/T feed equipment and determined that the testing had worn away some of the drill bit and galvanized reducer, which allowed a higher feed of S/T. The S/T feed equipment was rebuilt with a new drill bit and galvanized reducer, and one of the two drill bit flutes was plugged with silicone sealant.

The flow data for the second test are shown graphically, compared with the flow data mean of Phase I, II, and IV-R, in Figure 4-6.

The reduced constituent concentration tests were performed with a theoretical TSS concentration of 119 mg/L to 133 mg/L. Bypass was first observed after approximately 5,900 gallons of influent (with an approximate sediment load of 5.8 lb). On the second day of testing, after approximately 10,300 gallons of influent, a problem was noted with the OBC feeder plugging, and attempts were made to repair the feeder while continuing the test. At the end of the second day of testing, after approximately 13,700 gallons of influent (with an approximate sediment load of 13.5 lb), it was decided to eliminate the OBC feed from the synthetic wastewater because the Phase V test showed the OBC alone did not cause the filter media to physically blind. At this point, the treated effluent rate had diminished to approximately 12.5 gpm.

The testing resumed on the third day without the OBC feed. That morning, the treated effluent rate had recovered to 17.0 gpm, and was tapering off at a much slower pace than was observed during previous testing. At the end of this day of testing, the treated effluent rate was 12.9 gpm, which was greater than the flow rate of the day before, despite the additional mass of sediments that had entered the system. This finding led the TO to believe that a higher rate of blinding off results from a combination of the sediments and the hydrocarbons than from sediments alone.

The OBC feeder was repaired, and the test was resumed with the OBC feed on the fourth day. During this day of testing, the rate of filter media blinding was consistent with prior testing. This is represented in Figure 4-5 as the dashed line, which is a copy of the line after the OBC feed was resumed.

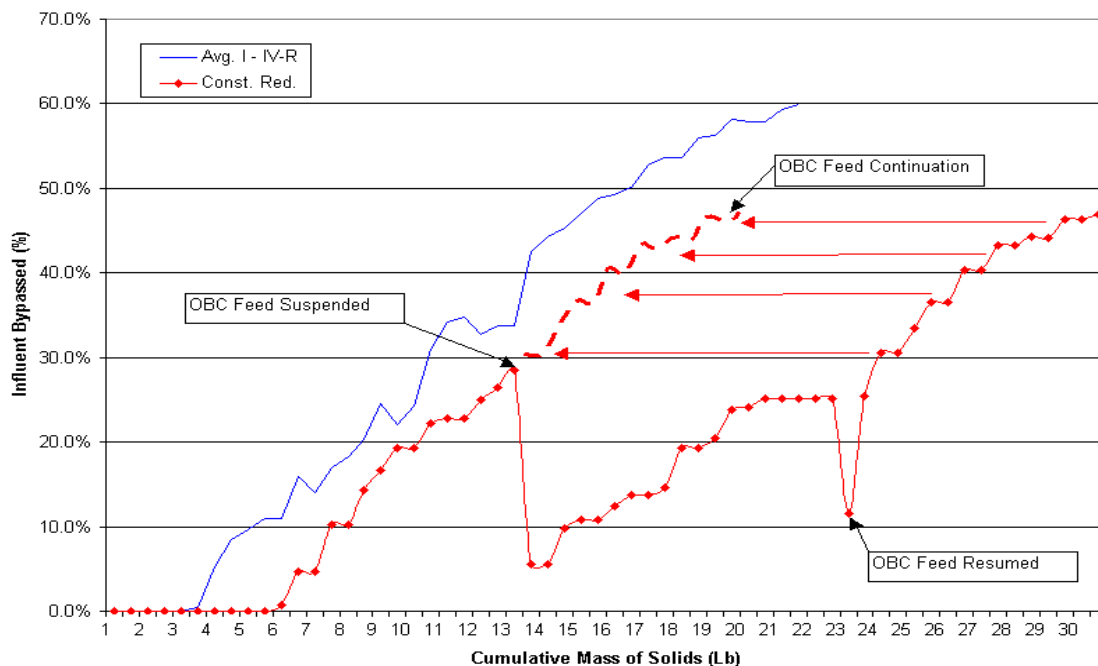

**Figure 4-5. Comparison of reduced constituent concentrations flow data with Phase I, II, and IV-R flow data.**

Based on these data, the reduced constituent concentrations test identified two important findings:

1. Hydro-Kleen™ blinding is most pronounced when a combination of hydrocarbons and sediments sorb to the filter media.
2. The Hydro-Kleen™ filter media blinded off with reduced theoretical TSS concentrations in a manner similar to tests conducted at higher theoretical TSS concentrations. This suggests the propensity for the filter media to blind can be represented as a function of the mass of sediment entering the unit. On average, during Phases I, II, and IV-R, every 3.1 lb (1.4 kg) of sediment entering the system would result in a 10 percent decrease in treated effluent flow. During the reduced constituent concentrations test, the initial bypass occurred after approximately six pounds of sediment entered the system, followed by a 10 percent decrease in flow for every 2.7 lb of sediment entering the system. Based on this information, it appears that for the sediment composition, concentrations, and influent flow rates used during this study, every three-pound addition of sediment in influent added to the system results in a reduction in treated effluent flow of approximately 10 percent.

#### **4.4.3 Installation and Operation & Maintenance Findings**

The TO performed O&M on the system as outlined in the vendor's written O&M procedures between test phases and as necessary during testing. O&M procedures and observations focused primarily on:

- Ease of installation;
- Weight of filter media bags, before and after testing;
- Clarity of written O&M procedures;
- Ease and time needed to clean unit and replace filter media; and
- Characteristics of waste materials.

##### 4.4.3.1 Installation

To evaluate the ease of installation of the Hydro-Kleen™ system, the TO installed the system in the test rig in accordance with the vendor's instructions for use in a catch basin. In general, the TO found the installation instructions were clear and the procedures were simple to follow.

Preliminary tests were run on the Hydro-Kleen™ system installed in the grate frame without the vendor-recommended silicone sealant between the stainless steel framing and the grate frame. Leakage was observed in the vicinity of the grate frame during these preliminary tests, but the extent of the leakage was not quantified. When the silicone sealant was applied, no leakage was observed. Based on this finding, sealing the Hydro-Kleen™ system to the grate frame in accordance with the vendor's instructions will minimize leakage.

##### 4.4.3.2 Filter Media Bags

The TO observed differences in the sizes and dry weights of the filter media bags from phase to phase. According to the vendor, the net weight of the carbon filter bags is supposed to be nine pounds. Two Sorb-44 bags are installed in the Hydro-Kleen™ system. The Sorb-44 media is much less dense than the carbon, and the vendor indicated the Sorb-44 bags are filled to an

uncompacted depth of approximately four inches, resulting in the bags weighing about two pounds each. Table 4-14 summarizes the weight of the bags used during testing.

**Table 4-14. Dry Weight of Filter Media Bags Before Testing**

Test Phase	Dry Sorb-44 Bags (lb)	Wet Sorb-44 Bags (lb)	Dry Carbon Bags (lb)	Wet Carbon Bags (lb)
I	4.4	6.3	11.3	17.1
II	3.5	8.7	7.0	12.4
III	4.9	7.4	8.7	14.1
IV	3.2	6.6	8.7	13.9
IV-R	3.5	5.1	8.6	13.9
V	4.3	11.9	9.1	13.6

The different filter bag weights had no apparent impact on the ease of installation or performance characteristics of the Hydro-Kleen™ system.

During installation of the new filter media bags prior to Phase II, one of the carbon filter bags split open at the seam between the cloth mesh and zipper, which is attached to the bag with a heat-activated adhesive. The bags should be handled with care during installation to prevent this from occurring.

The vendor recommends the filter media bags be installed “seam side up,” and indicates the seams are designed to fit snugly within the inner circumference of the filtration chamber. The filter media bags did fit snugly; however, the seams did not match the inner circumference exactly. In some cases, the seams were larger than the inner circumference, and puckering or wrinkling occurred. In other cases, the seams were slightly undersized, and did not reach the entire inner circumference. No correlation was observed between the filter bag size and performance characteristics or ease of O&M.

The filter media bags were saturated with tap water prior to testing and weighed prior to installation. When the carbon bag was saturated, carbon dust was observed coming out of the bag and the water turned a dark gray color. While this is typical of activated carbon, the dark gray water color could be an aesthetic consideration in an actual field application. The activated carbon dust cleared quickly and did not reappear once it was washed from the filter media.

#### 4.4.3.3 General O&M/System Cleanout

System cleanout consists of removing the storm grate and Hydro-Kleen™ diversion plate over the filter chamber, removing and replacing the filter media, vacuuming the settling chamber, and replacing the diversion plate and storm grate. During testing, the settling chamber was vacuumed with a wet/dry shop vacuum, and the procedure was found to be simple and straightforward. The most difficult task was removal of the heavy storm drain grate, which weighed approximately 180 lb, according to the vendor of the storm drain grate. A typical O&M session took approximately 15 minutes.

In the event of blinding off or bypass, the vendor recommends removing, shaking, and returning the filter media bags to the unit. This procedure was performed after the second day of Phase I

testing, and it was observed that this procedure does temporarily alleviate the blinding issue. However, once this was done, the used filter media blinded more quickly than new filter media.

Large volumes of sediments were observed on the filter media bags after high-flow testing events (Phase III and Phase IV), indicating that sediments do not settle in the settling chamber when flow rates exceed approximately 40 gpm. Figure 4-6 shows the inside of the Hydro-Kleen™ system after Test Phases I (low flow test) and III (high flow test), respectively.

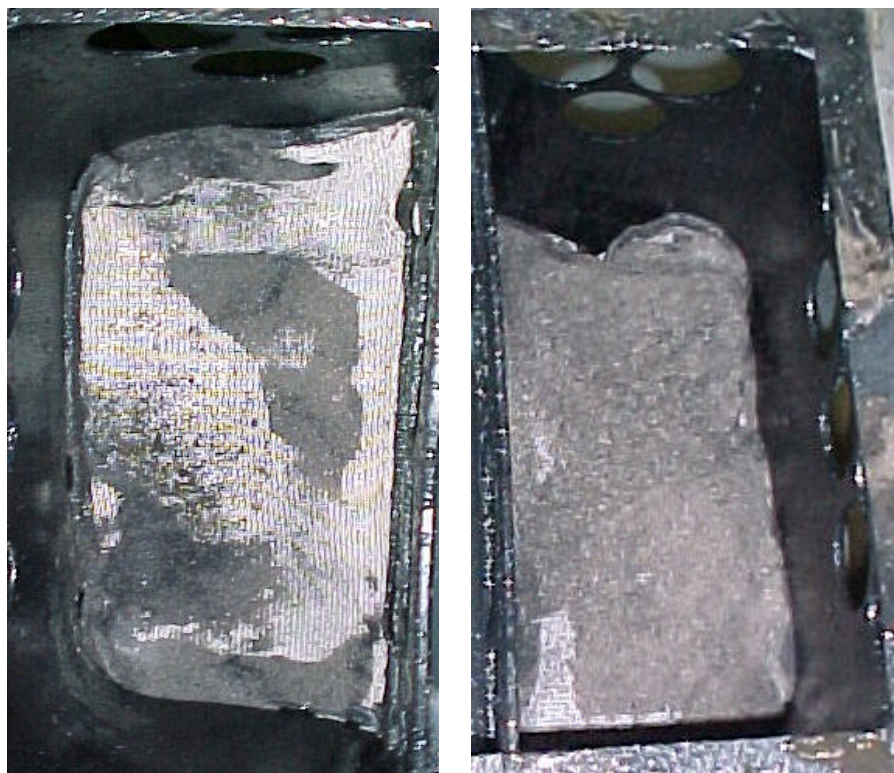

**Figure 4-6. Top of filtration chamber after Phase I (left) and Phase III (right) testing.**

Water would apparently seep out of the settling chamber through the riveted seam after approximately 24-48 hours of non-use. This may have a beneficial outcome in that reducing standing water sources can help control insect breeding.

#### 4.4.3.4 Waste Material Characterization

Waste material characterization focused on two primary areas: physical and chemical. Physical characterization determined the mass and volume of waste material generated during a cleanout session, while chemical characterization determined hazardous characteristics important in waste disposal considerations.

The filter media bags were weighed after the various testing phases. The Sorb-44 bags (approximately 3 to 5 lb dry) increased in wet weight to approximately 10 lb each, and the carbon bags (approximately 7 to 11 lb dry) weighed around 15 lb wet.

The contents of the settling chamber weighed between 60 and 85 pounds during cleanout, primarily dependent on the volume of water remaining inside. The liquid was decanted from the sediments of the settling chamber after Phases I, II, and IV-R, and the sediment was dried and weighed. The mass of the sediment retained by the unit can be compared to the mass of sediments in the synthetic wastewater, as shown in Table 4-15.

**Table 4-15. Dry Weight of Sediment Retained by Hydro-Kleen™ System**

Test Phase	Retained Sediment Dry Weight (lb)	Mass of Sediments in Synthetic Wastewater (lb)	Retention (Percent)
I	29.2	38.7	75
II	6.8	14.7	46
IV-R	13.0	27.0	48

The comparatively high retention rate in Phase I versus Phases II and IV-R would indicate that intermittent flow conditions promote solids settling and would, therefore, increase treatment efficiency as compared to continuous flow conditions. Additionally, the solids retention percentage, especially in the case of the Phase I data (75 percent), exceeded the cumulative bypass percentage (50 percent from Table 4-4). This would indicate that a portion of the solids (probably larger S/T particles) in the bypassed effluent were retained in the Hydro-Kleen™ unit. This condition was not as prominent in the Phase II and IV-R cumulative bypass (21 percent and 48 percent, respectively).

As waste materials were generated, representative composite samples of the spent filter media and recovered sediments were submitted for analysis for TCLP Resource Conservation and Recovery Act (RCRA) metals, copper and zinc, and TCLP Volatiles to determine if the waste materials were characteristically hazardous. The analytical results showed all TCLP analytes to be below detection limits except barium (0.25 mg/L) and zinc (1.84 mg/L). Based on these results, the waste was not characteristically hazardous, and the waste materials generated during this testing could be disposed at a Type II landfill, consistent with the vendor's claims. However, owners and operators of Hydro-Kleen™ units must make their own determination as to whether the waste materials being generated at their facilities are hazardous.

#### 4.5 Summary of Findings

A newly maintained Hydro-Kleen™ Filtration System is capable of reducing hydrocarbon and sediment concentrations in treated wastewater in a range of 50 to 95 percent, as measured by TPH and O&G analyses. The hydrocarbon treatment capabilities of the filter media decrease as a function of influent volume and constituent concentrations. The hydrocarbon treatment efficiency decreases to approximately 40 to 45 percent after approximately 2.5 L (0.7 gal) of hydrocarbons have been sorbed in the filter media, and the efficiency continues to decrease as the mass of hydrocarbons entering the system increases.

A Hydro-Kleen™ with new filter media can accept a hydraulic flow of approximately 20 to 30 gpm, without bypassing, depending on the concentration of contaminants in the wastewater. The maximum treated flow decreases as the sediment chamber and filter media trap contaminants, preventing water from flowing through the filter bags. This hydraulic flow rate is less than the 50 gpm flow rate claimed by the vendor.

In addition to hydrocarbon treatment, the Hydro-Kleen™ system was also capable of reducing suspended solids concentrations in the treated effluent. Sediment removal efficiency was measured three ways: (1) the TSS analytical method, (2) theoretical methods (measuring the mass of S/T and clay fed into the synthetic wastewater by the test rig), and (3) comparison of the dry weight of sediments in the influent to the dry weight of sediments removed from the system during cleaning. The different methods yielded results with a high degree of variance, with the analytical method producing the highest. The analytical method showed a mean sediment removal efficiency of 51 percent, with a range of -60 to 100 percent, while the theoretical method showed a mean efficiency of 82 percent, with a range of 55 to 100 percent in the treated effluent. These treatment efficiency calculations do not take into account the wastewater, which bypassed filtration through the filter holes. The removal efficiency from the total effluent (both treated and untreated) using the weighing method varied between 46 to 75 percent.

An important consideration in determining overall system efficiency is the propensity of contaminants to plug the filter media, resulting in untreated wastewater bypassing the filter media. Because there is no easy way to evaluate plugging of the filter media other than to visually inspect water passing through the bypass holes, frequent inspection and maintenance is vital to achieve and maintain high treatment efficiencies.

Filter media blinding, which is a function of the influent flow rate and hydrocarbon and sediment loading, can begin after as little as one pound of hydrocarbon-impacted sediments has entered the unit. The tendency of the system to blind is relatively low when either sediments or hydrocarbons enter the unit, but a combination of sediments and hydrocarbons results in the filter media plugging more rapidly. During this study, media blinding was observed at an approximate rate of 10 percent flow loss per three pounds of sediment in hydrocarbon- and sediment-impacted synthetic wastewater.

Although the vendor claims the Hydro-Kleen™ system is able to remove organically bound metals, the testing procedures were not able to create conditions to test this claim. The Hydro-Kleen™ did not demonstrate the ability to treat nutrients or surfactants in the wastewater, which is consistent with the vendor's claims.

O&M procedures are relatively simple and can be completed in approximately 15 minutes. Shaking and replacing the filter media bags, as recommended by the vendor, can help to temporarily restore the flow capacity to the system, but the shaken filter media will blind off quicker than new filter media.

#### **4.6 Vendor Comments**

Hydro Compliance Management, Inc. has reviewed this report and has prepared the discussion and conclusions contained in this section. The information presented in this section does not represent verified information.

As the initial participant to be verified against the EPA's ETV In-Drain Treatment Technology protocol, Hydro Compliance Management, Inc. had many of its claims for the Hydro-Kleen Filtration System verified. These include the technology's ability to remove substantial hydrocarbons and sediments from surface runoff. Hydro Compliance Management knew that the testing would be challenging to the technology and, as the first in-drain product to apply for and receive verification, that lessons would be learned in the process.

There were two main concerns for Hydro Compliance Management that arose during testing and are summarized in the verification report. The first was the flow rate of water through the media and the second was rapid clogging of the media. The Hydro-Kleen Filtration System experienced reduced treatment flow and substantial clogging during the ETV testing that Hydro Compliance Management had not observed in prior testing or in the field. Hydro Compliance Management has always strived to make supportable claims. Based on the results from the verification testing, Hydro Compliance Management arranged for further testing with Dr. Robert Pitt at the University of Alabama.

Upon completion of the ETV testing by NSF, Hydro Compliance Management sent a test unit to Dr. Pitt to determine flow rates and clogging characteristics of the treatment media. Dr. Pitt's report was finalized on October 27, 2003 and is available at [www.hydrocompliance.com/pitt-report](http://www.hydrocompliance.com/pitt-report). In summary, Dr. Pitt's report indicated that the Hydro-Kleen Filtration System was able to achieve a flow rate through the media up to 63 gpm without bypass. In addition, he did not observe clogging close to the degree that was seen in the ETV testing.

The main distinction between the ETV testing and Dr. Pitt's work is the type of particles used for clay sediment loadings. The ETV testing used OM-4 ball clay purchased from a modeling clay provider. Dr. Pitt utilized a different type of material. For the first test, he used a mixture containing 45% Si-Co-Sil 106 ground silica (available from U.S. Silica), 10% fine sand (sand blasting grade from Porter-Wagner), and 45% of a mixture of intermediate industrial abrasives (aluminum oxide). His report indicates that the "Si-Co-Sil had a particle size distribution centered around 5  $\mu\text{m}$  (U.S. Silica's specifications indicated 75% smaller than 45  $\mu\text{m}$ ), the fine sand was centered at about 300  $\mu\text{m}$ , and the abrasive mixture was evenly distributed between 10 and 80  $\mu\text{m}$ . The combination was very close to typical stormwater particle size distributions." (Pitt Hydro-Kleen Report, October 27, 2003, page 2). Dr. Pitt also conducted a second test using a mixture of 90% Si-Co-Sil 250 ground silica (50% passing 45  $\mu\text{m}$ ) and 10% of the fine sand.

Hydro Compliance Management discussions with several storm water experts indicated that the type of clay used in the ETV study would not typically be found in surface runoff. Further investigations by Hydro Compliance Management lead them to conclude that the type of clay utilized in the ETV testing caused a glue-like effect with the media and the hydrocarbon mix, resulting in the clogging problem and flow discrepancies between the ETV results and Dr. Pitt's results.

Overall, Hydro Compliance Management believes the verification was a success, and the testing verified the Hydro-Kleen's effectiveness as a hot-spot BMP for substantial capture of hydrocarbon and sediment constituents from surface runoff. As the only in-drain technology that has, to date, completed the rigorous ETV In-Drain testing, Hydro Compliance Management is



pleased that it was the initial participant, and looks forward to continuing to help improve the water quality of our receiving waters.

## Chapter 5

### Quality Assurance/Quality Control

The VTP included a Quality Assurance Project Plan (QAPP) with critical measurements identified and several QA/QC objectives established. The verification test procedures and data collection followed the QAPP, and summary results are reported in this section. The full laboratory QA/QC results and supporting documentation are presented in Appendices A, B and C.

#### 5.1 Audits

The VO conducted one audit of the NSF Hydraulics and Chemistry Laboratory during the verification test. The audit found that the field and laboratory procedures were generally being followed, and that the overall approaches being used were in accordance with the established QAPP. Recommendations for changes or improvements were made, and the responsible parties responded quickly to these recommendations. The audit report is presented in Appendix D.

#### 5.2 Precision

Throughout the verification test, the laboratory performed laboratory duplicates or matrix spike/matrix spike duplicates to monitor laboratory precision. Field duplicates were collected to monitor the overall precision of the sample collection and laboratory analyses. The VTP data quality objectives for precision were based on laboratory precision for the analyses. The VTP did not set field precision targets, as it was recognized that precision impacted by sampling and constituent mixtures would be highly constituent- and equipment-dependent.

The relative percent difference (RPD) recorded from the sample analyses was calculated to evaluate precision. RPD is calculated using the following formula:

$$\%RPD = \left( \frac{|x_1 - x_2|}{\bar{x}} \right) \times 100\%$$

where:

$x_1$  = Concentration of compound in sample

$x_2$  = Concentration of compound in duplicate

$\bar{x}$  = Mean value of  $x_1$  and  $x_2$

##### 5.2.1 Laboratory Precision Measurements

The laboratory performed laboratory duplicates (either duplicate aliquots or matrix spike/matrix spike duplicates) for COD, metals, phosphorus, MBAS, ammonia, TKN, and phenol. The precision for these parameters was good and within the control limits for the laboratory methods.

The laboratories also did duplicate analyses for O&G, TPH, TOC, BTEX, and TSS analyses. However, these duplicates are influenced by field sampling conditions, because separate sample bottles are required to perform each analysis. Therefore, the laboratory “duplicate” results or spiked duplicate results are on a duplicate sample taken in the field, as compared to duplicates

based on aliquots for the same sample bottle. The laboratory precision results are summarized in Tables 5-2 and 5-3. All of the data are presented in the Appendices to this report.

**Table 5-1. Duplicate Laboratory Sample RPD Summary**

Analyte	Number of Samples	Mean	Median	Maximum	Minimum	Standard Deviation	RPD Limits
O&G	4	12	12	19	4.0	6.5	0-25
TPH	4	20	14	47	3.0	19	0-30
TOC	3	5.5	1.4	14	1.1	7.4	0-20
COD	8	29	28	51	9.0	18	0-20
TSS	8	85	48	200	2.1	86	0-30

**Table 5-2. Laboratory MS/MSD Data Summary**

Analyte	Number of Samples	Mean	Median	Maximum	Minimum	Standard Deviation
Benzene	4	1.9	1.0	4.9	0.9	2.0
Ethylbenzene	4	3.2	3.2	6.5	0.0	2.8
MTBE	4	6.8	4.4	16	2.6	6.3
Toluene	4	3.3	3.1	6.2	0.9	2.8
Xylene	4	4.3	4.4	6.2	2.1	2.0
O&G	4	12	12	19	4.0	6.5
TPH	4	20	14	47	3.0	19
Aluminum	3	1.6	0.9	3.9	0.0	2.0
Cadmium	6	0.4	0.3	1.0	0.0	0.4
Chromium	6	8.0	7.6	14	4.5	3.3
Copper	6	4.6	5.1	9.2	0.5	3.3
Iron	5	2.6	2.6	6.5	0.0	2.3
Lead	6	0.7	0.8	1.4	0.0	0.6
Phosphate	3	0.0	0.0	0.0	0.0	0.0
Zinc	6	4.4	3.9	8.9	1.5	2.7
TOC	8	1.1	0.8	3.9	0.1	1.2
Phenol	7	6.9	4.5	15	0.6	6.0
MBAS	7	1.3	0.2	6.6	0.0	2.4
TKN	3	6.1	6.0	9.8	2.5	3.6
Ammonia	3	1.7	1.8	2.0	1.2	0.4

All of the TOC laboratory data was within the established precision limits, although this analysis may not have provided a true result for the samples, as discussed in this Section 5.5.

The COD, O&G, TPH, and TSS data showed lower precision, with some of the precision data outside the RPD limits that were based on laboratory precision. As stated above, these duplicate analyses rely on separate bottles taken in the field to provide samples for duplicates or matrix

spike/matrix spike duplicates. One TPH sample and two TSS samples exceeded the precision limits. For both TSS samples, the numbers were skewed by low and non-detected concentrations. In addition to sample duplicates, the laboratories analyzed laboratory control samples as part of the ongoing analysis process. The laboratory control samples were reviewed, and all methods were found to be in control (within established laboratory precision limits). Only one laboratory control sample (TPH) in the entire dataset was outside the set laboratory acceptance window. Laboratory procedures, calibrations, and data were audited and found to be in accordance with the published methods and good laboratory practice.

### 5.2.2 Field Precision Measurements

Field duplicates were collected for all constituents during the verification test. These samples were collected using separate samples and bottles and sent to the laboratories as individual samples. Summaries of the field duplicate data are presented in Table 5-3.

**Table 5-3. Duplicate Field Sample RPD Summary**

Analyte	Number of Samples	Mean	Median	Maximum	Minimum	Standard Deviation	Precision Ranges
Aluminum	4	34	15	100	4.9	46	0-30
Benzene	6	48	13	150	0.0	66	0-20
Cadmium	4	17	9.1	50	0.0	24	0-30
COD	7	46	35	140	16	42	0-20
Chromium	4	49	44	86	22	32	0-30
Copper	4	17	14	40	0.0	20	0-30
Ethylbenzene	6	52	32	130	2.4	52	0-20
Iron	4	6.3	4.6	16	0.0	7.7	0-30
MBAS	4	15	12	27	10	8.0	0-20
MTBE	6	0.0	0.0	0.0	0.0	0.0	0-20
Ammonia	4	1.0	1.0	2.2	0.0	1.2	0-10
O&G	6	42	34	100	7.5	33	0-25
Lead	4	49	46	100	0.0	43	0-30
TKN	4	12	11	29	0.0	12	0-20
TOC	5	4.6	4.0	12	0.0	4.6	0-20
Toluene	6	56	30	150	0.0	62	0-20
Phosphorus	4	17	20	29	0.0	12	0-10
TPH	8	26	31	50	0.0	18	0-30
Phenol	4	30	0.0	120	0.0	60	0-20
TSS	8	67	41	150	9.2	61	0-30
Xylene	6	52	33	130	4.7	50	0-20
Zinc	4	41	29	100	5.0	44	0-30

Several of the testing parameters showed poor precision for the field duplicates. Many of the high RPD deviations, including BTEX, metals, nutrients, and surfactants, are influenced by duplicate sample concentrations being very close to the method detection limits. When this occurs, low absolute differences between duplicate sample data can result in large calculated RPD values.

Four of the eight TSS duplicate sets exceeded 30 percent RPD. This is likely due to the inability of the S/T fed into the synthetic wastewater to disperse homogeneously and/or the difficulty of collecting samples in a small (40 mL) sample vial from a continuous stream of water flowing at a rate of several gallons per minute. This limitation was recognized and taken into consideration during the design of the testing procedures. Preliminary testing had shown that if large bottles were used, the sand settled to the bottom of the bottle and was not represented in the laboratory analysis even with vigorous shaking of the bottle. Therefore, small bottles were used for sampling TSS, and the entire content of the bottle was filtered. While this solved the laboratory analysis issue, it presented the problem that field duplicates taken in small bottles could vary due to variation in the dry feeder on a minute-by-minute basis. Therefore, while influent analysis was included in the test plan, the influent TSS (and TPH, O&G, and other parameters) was also monitored based on the weight of material feed to the unit. By utilizing the redundant method of calculating the theoretical TSS using the weights of the solids feed by the feeder and the volumes of the influent water, the influent concentration of the water could be calculated for each period of testing.

Three of the six O&G sample sets exceeded the 25 percent RPD precision range. For each of these sets of samples, the O&G concentrations were near or below analytical detection limits. Even though the RPD is high, the data is reasonable given the low concentration found in the samples.

Five of the eight TPH sample sets exceeded the 30 percent RPD precision range. Of these, two datasets were for results at or below detection limits. One duplicate was an influent sample on the third day of Phase I testing, when there was an apparent issue with the hydrocarbon feeder (based on other analytical data), and the other two were influent samples from other testing phases. These high RPDs may be due to oil-based feeder not dispensing hydrocarbons homogeneously on a continuous basis. Also, while there was vigorous mixing of the influent water at the point of sample collection, many of hydrocarbons are not soluble and therefore samples may have contained varying amounts of insoluble hydrocarbons at any given time.

The design of the sampling program anticipated that precision might be low for some of the constituents due to the nature of the water being tested. The sampling plan included collection of several aliquots over time to make composite samples. The data evaluation also was based on mean data collected over a large volume of flow and long time periods. This approach was used to help mitigate minute-by-minute changes that might occur in the water, particularly in the influent water. Also, the careful monitoring of the total volume of water used and the total mass of constituents fed to the system provided a basis for calculating influent concentration. The sampling techniques and laboratory procedures were carefully reviewed before and during the test. The procedures used were in accordance with best sampling practice, and the laboratory methods and procedures were found to be performed in accordance with the published methods.

### 5.3 Accuracy

Method accuracy was determined and monitored using a combination of matrix spikes and laboratory control samples (known concentration in blank water) depending on the method. Recovery of the spiked analytes was calculated and monitored during the verification test. Accuracy was in control throughout the verification test. Table 5-4 show a summary of the laboratory control sample recovery data.

**Table 5-4. Laboratory Control Sample Data Summary**

Analyte	Number of Samples	Mean	Median	Maximum	Minimum	Standard Deviation	QC Limits
Benzene	9	96.1	96.0	105	89.0	5.1	80-120
Ethylbenzene	9	101	101	114	93.0	7.0	80-120
MTBE	9	113	110	126	107	7.4	80-120
Toluene	9	107	106	112	104	2.9	80-120
Xylene	9	100	99.0	111	90.0	7.3	80-120
Cadmium	3	106	106	106	106	0.3	70-130
Chromium	3	103	104	105	102	1.7	70-130
Copper	3	103	102	106	100	3.0	70-130
Iron	3	93.0	93.0	96.9	89.2	3.9	70-130
Lead	3	100	101	101	99.1	1.1	70-130
Zinc	3	110	110	112	106	3.0	70-130
TOC	17	96.5	97.5	100	88.9	3.2	80-120
Phenol	2	103	103	110	96.6	9.3	70-130
MBAS	6	88.8	91.6	104	72.5	12	50-150
TKN	2	92.5	92.5	109	76.0	23	70-130
Ammonia	2	110	110	113	108	3.2	70-130
COD	8	97.7	96.7	109	86.7	6.9	80-120
TSS	7	102	99.4	125	88.7	12	N/A
TPH	6	81.3	85.5	87.0	69.0	7.9	64-132
O&G	5	84.0	83.0	94.0	78.0	6.0	78-114

All the samples were within the quality control limits with the exception of one MTBE sample, which exceeded its laboratory control sample limit. This does not raise a concern, because all other MTBE samples collected during testing were below detection limits.

The balance used for TSS analysis was calibrated routinely with weights that were National Institute of Standards and Technology (NIST) traceable. Calibration records were maintained by the laboratory and inspected during the on site audits. The temperature of the drying oven was also monitored using a thermometer that was calibrated with a NIST-traceable thermometer.

## 5.4 Representativeness

The field procedures were designed to ensure that representative samples were collected of both influent and effluent wastewater. Supervisor oversight and audits provided assurance that procedures were being followed. As discussed earlier, the challenge in sampling wastewater is obtaining representative samples. The data indicated that while individual sample variability might occur, the long-term trend in the data was representative of the concentrations in the wastewater, and redundant methods of evaluating key constituent loadings in the wastewater were utilized to compensate for the variability of the laboratory data.

The laboratories used standard analytical methods and written standard operating procedures for each method to provide a consistent approach to all analyses. Sample handling, storage, and analytical methodology were reviewed during the on-site and internal audits to verify that standard procedures were being followed. The use of standard methodology, supported by proper quality control information and audits, ensured that the analytical data were representative of the actual wastewater conditions.

## 5.5 Completeness

The VTP set a series of goals for completeness. During the startup and verification testing, flow data were collected for each day at a minimum of once per hour for Phases II, IV, and V, and once per active flow setting for Phases I and III. The flow records are 100 percent complete. In addition, the constituent weight data gathered before, during, and after each test phase are also 100 percent complete.

Four scheduled analyses had to be omitted from the testing program. The first influent composite sample for COD analysis on the first day of Phase I testing was not collected, but the corresponding effluent sample was collected and analyzed. Though the effluent COD sample was analyzed in accordance with proper laboratory analytical procedures, it was omitted because there was not a corresponding influent COD sample for comparison. On the third day of Phase I sampling, an influent composite sample was collected for TOC analysis while the corresponding effluent sample was collected for COD analysis. Though the analyses were conducted in accordance with proper laboratory analytical procedures, the data were omitted from the testing program because the results could not be correlated. This results in four omitted data points from a total of 751 data points, resulting in 99.5 percent completeness, which exceeds the 80 percent completeness goal for this program.

The BTEX/MTBE and TOC analytical samples were all collected and analyzed in accordance with the Test Plan. However, it was discovered that, due to the free product (insoluble hydrocarbons) in the sample containers, the analyses were not representative of the actual constituents in the sample. These analyses are performed by placing the 40 mL sample container on an auto-sampler device. The samples sit in the auto-sampler, which allows the hydrocarbons to separate and float to the surface. The sample for analysis is obtained by puncturing the septum on the sample container with a needle and drawing a sample from near the bottom of the container. Therefore, the sample only represents the soluble fraction of the hydrocarbon present. Given the inability of the auto-sampling devices to collect a representative aliquot from a heterogeneous sample, the data could not be used to evaluate the performance of the Hydro-Kleen™ unit. This results in the elimination of 229 data points that could have been used to evaluate the performance of the unit, and would result in 69.5 percent completeness. The TOC

data were being collected as an indicator parameter for tracking breakthrough and unit operation. TPH and O&G were the key parameters for evaluating the system hydrocarbon removal performance. Therefore, the lack of TOC data did not impact the verification of performance for TPH and O&G.

This analytical issue necessitates a protocol modification to eliminate the BTEX/MTBE and TOC sampling program, because representative samples cannot be analyzed using currently available methods. This was the first study completed under this protocol, and part of its function was to evaluate various aspects of the protocol. This analytical issue will also impact “real-world” databases for storm water monitoring and other similar environmental monitoring program. If the samples contain floating hydrocarbons, the TOC and BTEX results will not accurately measure these non-aqueous phase liquid materials.



## References

- (1) NSF International, *Protocol for the Verification of In-Drain Treatment Technologies*, Ann Arbor, MI, April 2001.
- (2) NSF International, *Verification Test Plan For Hydro Compliance Management, Inc. Hydro-Kleen™ Filtration System*, Ann Arbor, MI, February 2002.
- (3) United States Environmental Protection Agency: *Environmental Technology Verification Program - Quality and Management Plan for the Pilot Period (1995 – 2000)*, USEPA/600/R-98/064. Office of Research and Development, Cincinnati, OH, 1998.
- (4) NSF International, *Environmental Technology Verification – Source Water Protection Technologies Pilot Quality Management Plan*, Ann Arbor, MI, 2000.
- (5) United States Environmental Protection Agency: *Methods and Guidance for Analysis of Water*, EPA 821-C-99-008, Office of Water, Washington, DC, 1999..
- (6) United States Environmental Protection Agency: *Methods for Chemical Analysis of Water and Wastes*, EPA 600/4-79-020, revised March 1983. .
- (7) United States Environmental Protection Agency: *Test Methods for Evaluating Solid Waste: Physical/Chemical Methods 3rd ed - 4 vols.*, November 1986. Final Update IIB and Proposed Update III, January 1995.
- (8) APHA, AWWA, and WEF: *Standard Methods for the Examination of Water and Wastewater, 20<sup>th</sup> Edition*, Washington, DC, 1998.
- (9) United States Environmental Protection Agency: *USEPA Guidance for Quality Assurance Project Plans, USEPA QA/G-5*, USEPA/600/R-98-018, Office of Research and Development, Washington, DC, 1998.
- (10) United States Environmental Protection Agency, *Guidance for the Data Quality Objectives Process, USEPA QA/G-4*, USEPA/600/R-96-055, Office of Research and Development, Washington, DC, 1996.

## Appendices

- A Verification Test Plan with Operations and Maintenance Manual.
- B Laboratory Analytical Reports.
- C Testing Equipment Specifications.
- D Audit Report.

**NOTE: Appendices are not included in this report. Appendices are available from NSF International upon request.**

## Glossary

**Accuracy** - a measure of the closeness of an individual measurement or the mean of a number of measurements to the true value and includes random error and systematic error.

**Bias** - the systematic or persistent distortion of a measurement process that causes errors in one direction.

**Commissioning** – the installation of the in-drain removal technology and start-up of the technology using test site wastewater.

**Comparability** – a qualitative term that expresses confidence that two data sets can contribute to a common analysis and interpolation.

**Completeness** – a qualitative term that expresses confidence that all necessary data have been included.

**Precision** - a measure of the agreement between replicate measurements of the same property made under similar conditions.

**Protocol** – a written document that clearly states the objectives, goals, scope, and procedures for the study. A protocol shall be used for reference during vendor participation in the verification testing program.

**Quality Assurance Project Plan** – a written document that describes the implementation of quality assurance and quality control activities during the life cycle of the project.

**Residuals** – the waste streams, excluding final effluent, that are retained by or discharged from the technology.

**Representativeness** - a measure of the degree to which data accurately and precisely represent a characteristic of a population parameter at a sampling point, a process condition, or environmental condition.

**Source Water Protection Stakeholder Advisory Group** - a group of individuals consisting of any or all of the following: buyers and users of in-drain removal and other technologies, developers and vendors, consulting engineers, the finance and export communities, and permit writers and regulators.

**Standard Operating Procedure** – a written document containing specific procedures and protocols to ensure that quality assurance requirements are maintained.

**Technology Panel** - a group of individuals with expertise and knowledge of in-drain treatment technologies.

**Testing Organization** – an independent organization qualified by the Verification Organization to conduct studies and testing of mercury amalgam removal technologies in accordance with protocols and Test Plans.

**Vendor** – a business that assembles or sells in-drain treatment equipment.

**Verification** – to establish evidence on the performance of in-drain treatment technologies under specific conditions, following a predetermined study protocol(s) and test plan(s).

**Verification Organization** – an organization qualified by EPA to verify environmental technologies and to issue verification statements and verification reports.

**Verification Report** – a written document containing all raw and analyzed data, all quality assurance/quality control (QA/QC) data sheets, descriptions of all collected data, a detailed description of all procedures and methods used in the verification testing, and all QA/QC results. The test plan(s) shall be included as part of this document.

**Verification Statement** – a document that summarizes the Verification Report reviewed and approved and signed by EPA and NSF.

**Verification Test Plan** – a written document prepared to describe the procedures for conducting a test or study according to the verification protocol requirements for the application of in-drain treatment technology. At a minimum, the test plan shall include detailed instructions for sample and data collection, sample handling and preservation, precision, accuracy, goals, and QA/QC requirements relevant to the technology and application.