

US EPA ARCHIVE DOCUMENT

Environmental Technology Verification Report

Paint Overspray Arrestor
Koch Filter Corporation
Duo-Pak 650

US EPA ARCHIVE DOCUMENT

Prepared by



Research Triangle Institute

Under a Cooperative Agreement with



U.S. Environmental Protection Agency



Environmental Technology Verification Report

Paint Overspray Arrestor

Koch Filter Corporation Duo-Pak 650

Prepared by

Kathleen Owen
James Hanley
Jack Farmer

Air Pollution Control Technology Program
Research Triangle Institute
Research Triangle Park, NC 27709-2194

EPA Cooperative Agreement CR 826152-01-2

EPA Project Manager: Theodore G. Brna
Air Pollution Prevention and Control Division
National Risk Management Research Laboratory
Research Triangle Park, NC 27711

March 2000

Notice

This document was prepared by the Research Triangle Institute (RTI) under Cooperative Agreement No. CR826152-01-2 with the U.S. Environmental Protection Agency (EPA). The document has been subjected to EPA's peer and administrative reviews and has been approved for publication. Mention of corporation names, trade names, or commercial products does not constitute endorsement or recommendation for use of specific products.

Availability of Verification Statement and Report

Copies of the public Verification Statement and Verification Report are available from the following:

1. **Research Triangle Institute**

P.O. Box 12194
Research Triangle Park, NC 27709-2194

Web site: <http://etv.rti.org/apct/index.html>
or <http://www.epa.gov/etv> (*click on partners*)

2. **USEPA / APPCD**

MD-4
Research Triangle Park, NC 27711

Web site: <http://www.epa.gov/etv/library.htm> (*electronic copy*)
<http://www.epa.gov/ncepihom/>

Abstract

Paint overspray arrestors (POAs) were evaluated by the Air Pollution Control Technology (APCT) pilot of the Environmental Technology Verification (ETV) Program. The performance factor verified was the particle filtration efficiency as a function of size for particles smaller than 10 μm . The APCT ETV Program developed a generic verification protocol for testing filtration efficiency that is based on EPA Method 319. The protocol was developed by RTI, reviewed by a technical panel of experts, and approved by EPA. The protocol addresses several issues that Method 319 does not cover, including periodic testing, acquisition of POAs for testing, and product definition. A Test/Quality Assurance Plan was prepared which addresses the test procedure and quality assurance and quality control requirements for obtaining verification data of sufficient quantity and quality to satisfy the data quality objectives.

RTI performed tests on Koch's Duo-Pak 650 during the period October 6-8, 1999. Filter efficiencies were determined. For ready comparison, the filtration efficiency requirements of the National Emission Standards for Hazardous Air Pollutants (NESHAP) are tabulated with the test results. The results indicate that the Duo-Pak 650 met the NESHAP requirements for existing sources.

Table of Contents

	<u>Page</u>
Verification Statement	i
Notice	vii
Availability of Verification Statement and Report	viii
Abstract	ix
List of Figures	xi
List of Tables	xi
List of Abbreviations and Acronyms	xii
Acknowledgments	xiii
Section 1. Introduction	1
Section 2. Verification Test Description	1
2.1. Selection of Paint Overspray Arrestors for Testing	3
Section 3. Description of Arrestor	3
Section 4. Verification of Performance	3
4.1. Quality Assurance	3
4.2. Results	3
4.3. Limitations and Applications	4
Section 5. References	4
Appendix A. Description of the Test Rig and Methodology	A-1
Appendix B. Certificates of Calibration	B-1
Appendix C. Fractional Efficiency Data Sheets	C-1

List of Figures

	<u>Page</u>
Figure 1. Photograph of the Koch Duo-Pak 650 paint overspray arrestor	iii
Figure 2. Triplicate solid-phase particle removal efficiency curves for Koch Duo-Pak 650 paint overspray arrestor	7
Figure 3. Average of the solid-phase particle removal efficiency curves for Koch Duo-Pak 650 paint overspray arrestor.	8
Figure 4. Triplicate liquid-phase particle removal efficiency curves for Koch Duo-Pak 650 paint overspray arrestor	9
Figure 5. Average of the liquid-phase particle removal efficiency curves for Koch Duo-Pak 650 paint overspray arrestor	10
Figure A-1. Schematic illustration of the fractional efficiency test rig	A-2

List of Tables

Table 1. Existing Sources: Liquid-Phase Challenge Aerosol Particles	iv
Table 2. Existing Sources: Solid-Phase Challenge Aerosol Particles	iv
Table 3. New Sources: Liquid-Phase Challenge Aerosol Particles	iv
Table 4. New Sources: Solid-Phase Challenge Aerosol Particles	iv
Table 5. Test Series	2
Table 6. Summary of Solid-Phase Test Results	5
Table 7. Summary of Liquid-Phase Test Results	6
Table 8. Summary of Pressure Drop Measurements	11
Table A-1. Physical and Aerodynamic Sizing Channels for the Calibration and Test Aerosols	A-6

List of Abbreviations and Acronyms

APCT	Air Pollution Control Technology
APPCD	Air Pollution Prevention and Control Division
ASME	American Society of Mechanical Engineers
cfm	cubic feet per minute
cm	centimeter
Diam.	Diameter
DQO	data quality objective
EPA	U.S. Environmental Protection Agency
ETV	Environmental Technology Verification
fpm	feet per minute
ft ³	cubic foot
g	gram
Geo.	geometric
HEPA	high efficiency particulate air
ID	inside diameter
in.	inch
kW	kilowatt
L	liter
mL	milliliter
mm	millimeter
m/s	meters per second
NESHAP	National Emission Standards for Hazardous Air Pollutants
OPC	optical particle counter
Pa	pascal
POA	paint overspray arrestor
PSL	polystyrene latex
QA	quality assurance
RTI	Research Triangle Institute
s or sec	second
µm or um	micrometer

Acknowledgments

RTI acknowledges the support of all those who helped plan and conduct the verification activities. In particular, we would like to thank Ted Brna, EPA Project Manager, and Paul Groff, EPA Quality Manager, of EPA's National Risk Management Research Laboratory in Research Triangle Park, NC. Finally we would like to acknowledge the assistance and participation of David Koch and Mike Snow of Koch.

For more information on the Paint Overspray Arrestor Verification Testing, contact

James Hanley
Research Triangle Institute
P.O. Box 12194
Research Triangle Park, NC 27709-2194
(919) 541-5811

For more information on the Koch Duo-Pak 650, contact

David Koch and Mike Snow
Koch Filter Corporation
P.O. Box 3186
Louisville, KY 40201-3138
(502) 634-4796

SECTION 1 INTRODUCTION

The U.S. Environmental Protection Agency (EPA) has created the Environmental Technology Verification (ETV) Program to facilitate the deployment of innovative or improved technologies through performance verification and information dissemination. The ETV Program is intended to assist and inform those involved in the design, distribution, permitting, and purchase of environmental technologies.

The U.S. EPA's partner in the Air Pollution Control Technology (APCT) Program is Research Triangle Institute (RTI). The APCT Program, with the full participation of the technology developer, develops plans, conducts tests, collects and analyzes data, and reports findings. The evaluations are conducted according to a rigorous protocol and quality assurance and quality control oversight. The APCT Program verifies the performance of commercial-ready technologies used to control air pollutant emissions, with an emphasis on technologies for controlling particulate matter, volatile organic compounds, nitrogen oxides, and hazardous air pollutants. The Program develops standardized verification protocols and test plans, conducts independent testing of technologies, and prepares verification test reports and statements for broad dissemination.

SECTION 2 VERIFICATION TEST DESCRIPTION

The paint overspray arrestor was tested in accordance with the APCT "Generic Verification Protocol for Paint Overspray Arrestors"¹ and the "Test/QA Plan for Paint Overspray Arrestors."² This protocol incorporates all requirements of EPA Method 319: Determination of Filtration Efficiency for Paint Overspray Arrestors. Method 319³ is part of the National Emission Standards for Hazardous Air Pollutants (NESHAP) for Aerospace Manufacturing and Rework Facilities.⁴ The protocol also includes requirements for quality management, quality assurance, procedures for product selection, auditing of the test laboratories, and reporting format.

Filtration efficiency was computed from aerosol concentrations measured upstream and downstream of an arrestor installed in a laboratory test rig. The aerosol concentrations upstream and downstream of the arrestors were measured with an aerosol analyzer that simultaneously counts and sizes the particles in the aerosol stream. The aerosol analyzer covered the particle diameter size range from 0.3 to 10 μm in a series of contiguous sizing channels. Each sizing channel covered a narrow range of particle diameters. For example, channel 1 covered from 0.3 to 0.4 μm , channel 2 from 0.4 to 0.5 μm , and channel 15 from 7 to 10 μm . Using the ratio of the downstream to upstream particle counts for each channel, the filtration efficiency was computed for each of the sizing channels.

The upstream and downstream aerosol measurements were made while a test aerosol was injected into the air stream upstream of the arrestor [ambient aerosol is first removed from the upstream air with high efficiency particulate air (HEPA) filters on the inlet of the test rig]. This test aerosol spanned the particle

size range from 0.3 to 10 µm and provided a sufficient upstream concentration in each of the sizing channels to allow accurate calculation of filtration efficiencies up to 99%.

The following series of tests were performed at a face velocity of 120 fpm (0.61 m/s):

- C Three arrestors were tested using a liquid-phase aerosol challenge,
- C Three arrestors were tested using a solid-phase aerosol challenge,
- C Seven “no-filter” control tests (one performed prior to each arrestor and reference filter test),
- C One HEPA filter control test, and
- C One reference filter control test.

The test series is exhibited in Table 5. Additional details on the test procedure are provided in Appendix A.

TABLE 5. TEST SERIES

RTI Test No.	TYPE OF TEST				Challenge Aerosol
	No-Filter	Test Arrestor	HEPA Filter	Reference Filter	
10069904	X				Solid-Phase
10069905				X	
10069906	X				
10069907		X			
10069908	X				
10079901		X			
10079902	X				
10079903		X			
10059902			X		
10079904	X				Liquid-Phase
10079905		X			
10079906	X				
10089901		X			
10089902	X				
10089903		X			

2.1 SELECTION OF PAINT OVERSPRAY ARRESTORS FOR TESTING

The test arrestors (Duo-Pak 650) were supplied to the test laboratory directly from the manufacturer with a letter from David Koch, General Sales Manager, attesting that the arrestors were selected randomly from the existing inventory, were manufactured to the specified bill of materials for this product, and were treated as any order.

SECTION 3 DESCRIPTION OF ARRESTOR

As shown in Figure 1 (page iii), the Koch Duo-Pak 650 is a three pocket bag filter with nominal dimensions of 24 x 24 x 15 in. (0.61 x 0.61 x 0.38 m). The media is off-white upstream and light blue-green downstream. The 1.5 x 3 in. label is sewn onto the arrestor and is white with blue lettering. The label states Koch DUO-PAK 650, Koch Filter Corporation, Louisville, KY 40208. There is no label indication of the flow direction or filter orientation, so the industry standard orientation with the bags extended horizontally in the direction of the airflow and the individual bags side-by-side, as opposed to stacked vertically, was used in the tests.

SECTION 4 VERIFICATION OF PERFORMANCE

4.1 QUALITY ASSURANCE

The verification tests were conducted in accordance with an approved Test/Quality Assurance (QA) Plan.² The EPA Quality Manager conducted an independent assessment of the test laboratory in August 1999 and found that the test laboratory was being operated as specified in the Test/QA Plan. Additionally, APCT Quality Assurance staff have reviewed the results of this test and have found that the results meet data quality objectives in the Test/QA Plan. Certificates of Calibration for the optical particle counter and the airflow reference devices are provided in Appendix B.

4.2 RESULTS

Tables 6 and 7 and Figures 2 through 5 summarize the fractional filtration efficiency measurements for the solid- and liquid-phase tests. Upstream and downstream particle count data for each test are provided in Appendix C.

The initial (new condition) pressure drop across each test arrestor at the 120 fpm (0.61 m/s) test velocity [for a flowrate of 480 cfm (0.23 m³/s)] is shown in Table 8. The pressure drop across the tested arrestors ranged from 0.08 to 0.10 in. H₂O (20 to 25 Pa) for each of the six arrestors tested.

Tables 1-4 (page iv) present the filtration efficiency requirements of the Aerospace NESHAP and the corresponding efficiencies measured for the tested arrestor system. The test results indicate that the tested arrestor met the requirements listed in Tables 1 and 2 for existing sources but not those listed in Tables 3 and 4 for new sources.

4.3 LIMITATIONS AND APPLICATIONS

This verification report addresses two aspects of paint overspray arrestor performance: filtration efficiency and pressure drop. Users of this technology may wish to consider other performance parameters such as service life and cost when selecting a paint overspray arrestor for their use.

In accordance with the generic verification protocol, this Verification Statement is applicable to paint overspray arrestors manufactured between the publication date of the Verification Statement and 12 months thereafter.

As stated in Section 1.3 of Method 319³, "for a paint arrestor system or subsystem which has been tested by this method, adding additional filtration devices to the system or subsystem shall be assumed to result in an efficiency of at least that of the original system without additional testing."

SECTION 5 REFERENCES

1. Generic Verification Protocol for Paint Overspray Arrestors, Research Triangle Institute, Research Triangle Park, NC, August 1999.
2. Test/QA Plan for Paint Overspray Arrestors, Research Triangle Institute, Research Triangle Park, NC, February 1999.
3. Method 319: Determination of Filtration Efficiency for Paint Overspray Arrestors. *Code of Federal Regulations*, Appendix A to 40 CFR Part 63.
4. National Emission Standards for Hazardous Air Pollutants for Aerospace Manufacturing and Rework Facilities. *Code of Federal Regulations*, Title 40, Part 63, Subpart GG (40 CFR 63.741).

TABLE 6. SUMMARY OF SOLID-PHASE TEST RESULTS

		Filtration Efficiency (%) at Indicated Size Range														
OPC Channel Number		1	2	3	4	5	6	7	8	9	10	11	12	13	14	15
Min. Diam. (um)		0.45	0.59	0.73	0.80	1.02	1.44	1.86	2.28	2.85	3.13	4.25	5.66	7.07	7.77	9.88
Max. Diam. (um)		0.59	0.73	0.80	1.02	1.44	1.86	2.28	2.85	3.13	4.25	5.66	7.07	7.77	9.88	14.10
Geo. Mean Diam (um)		0.52	0.66	0.77	0.90	1.21	1.64	2.06	2.55	2.98	3.65	4.91	6.33	7.41	8.76	11.81
Koch Duo-Pak 650																
Run #1	10069907	33	41	45	48	56	64	72	76	79	83	90	94	96	97	99
Run #2	10079901	34	41	45	49	57	66	72	77	80	84	90	94	97	98	99
Run #3	10079903	33	42	45	49	56	65	71	77	78	84	89	94	96	97	99
Average		33	41	45	49	56	65	72	77	79	84	90	94	96	98	99
Interpolated Efficiency Values (%) for Existing Source Criteria:																
	2.60 um (> 10% required):	77														
	5.00 um (> 50% required):	90														
	8.10 um (> 90% required):	97														
Interpolated Efficiency Values (%) for New Source Criteria:																
	0.70 um (> 75% required):	43														
	1.10 um (> 85% required):	53														
	2.50 um (> 95% required):	76														
HEPA Filter Control Test (applicable to both solid and liquid phase conditions)																
Run #1	10059902	100	100	100	100	100	100	100	100	100	100	100	100	100	100	100
Reference Filter QA Test																
Current	10069905	-1	1	3	2	3	4	7	8	10	13	23	37	48	61	78
Baseline	07279902	0	0	0	0	1	0	3	5	3	10	20	40	54	65	81
Difference		-1	1	3	2	2	4	3	3	7	3	3	-3	-6	-4	-4
Acceptable (<10%)		yes	yes	yes	yes	yes	yes	yes	yes	yes	yes	yes	yes	yes	yes	yes
"No Filter" Control Tests																
		Penetration For Each Size Range														
Run #1	10069906	1.00	1.00	1.01	1.00	1.00	1.00	1.02	0.99	1.00	1.00	0.99	0.95	0.94	0.89	0.83
Run #2	10069908	1.00	1.00	0.99	1.00	1.00	1.01	1.01	1.00	1.00	1.00	0.99	0.94	0.99	0.92	0.85
Run #3	10079902	1.00	1.01	1.01	1.00	1.01	1.03	1.01	1.00	0.98	1.01	0.98	0.96	0.89	0.83	0.76

TABLE 7. SUMMARY OF LIQUID- PHASE TEST RESULTS

		Filtration Efficiency (%) at Indicated Size Range														
OPC Channel Number		1	2	3	4	5	6	7	8	9	10	11	12	13	14	15
Min. Diam. (um)		0.28	0.37	0.47	0.52	0.66	0.94	1.22	1.51	1.88	2.07	2.83	3.77	4.71	5.18	6.60
Max. Diam. (um)		0.37	0.47	0.52	0.66	0.94	1.22	1.51	1.88	2.07	2.83	3.77	4.71	5.18	6.60	9.43
Geo. Mean Diam (um)		0.32	0.418	0.49	0.58	0.78	1.07	1.36	1.68	1.97	2.42	3.26	4.21	4.94	5.85	7.89
Koch Duo-Pak 650																
Run #1	10079905	24	29	31	32	37	43	49	59	61	67	78	87	91	94	97
Run #2	10089901	24	28	27	30	35	41	48	56	58	66	78	87	92	96	98
Run #3	10089903	22	28	29	31	35	41	49	57	61	66	79	87	92	96	98
Average		23	29	29	31	36	41	49	58	60	66	78	87	92	96	98
Interpolated Efficiency Values (%) for Existing Source Criteria:																
2.20 um (> 10% required):		63														
4.10 um (> 50% required):		86														
5.70 um (> 90% required):		95														
Interpolated Efficiency Values (%) for New Source Criteria:																
0.42 um (> 65% required):		29														
1.00 um (> 80% required):		40														
2.00 um (> 95% required):		61														
"No Filter" Control Tests		Penetration For Each Size Range														
Run #1	10079904	1.00	0.99	1.01	0.99	1.00	1.01	0.99	0.98	0.99	1.00	0.99	0.95	0.89	0.83	0.66
Run #2	10079906	1.00	0.98	0.97	0.98	1.00	1.01	1.01	1.00	0.99	1.01	1.01	1.01	0.99	1.01	0.94
Run #3	10089902	0.99	1.01	1.00	1.00	1.00	1.00	1.01	1.01	1.01	1.01	1.02	1.02	0.99	1.00	0.87

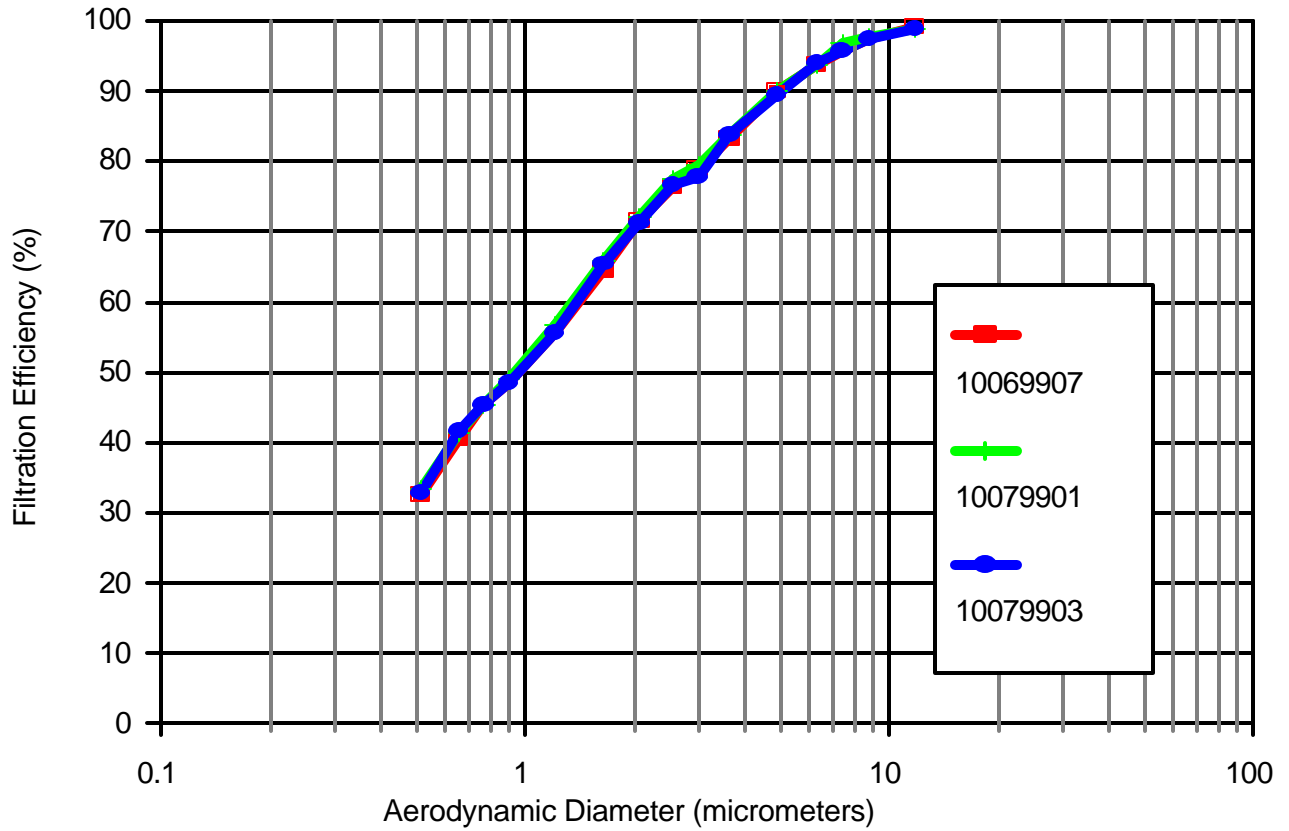

Figure 2. Triplicate solid-phase particle removal efficiency curves for the Koch Duo-Pak 650 paint overspray arrestor.

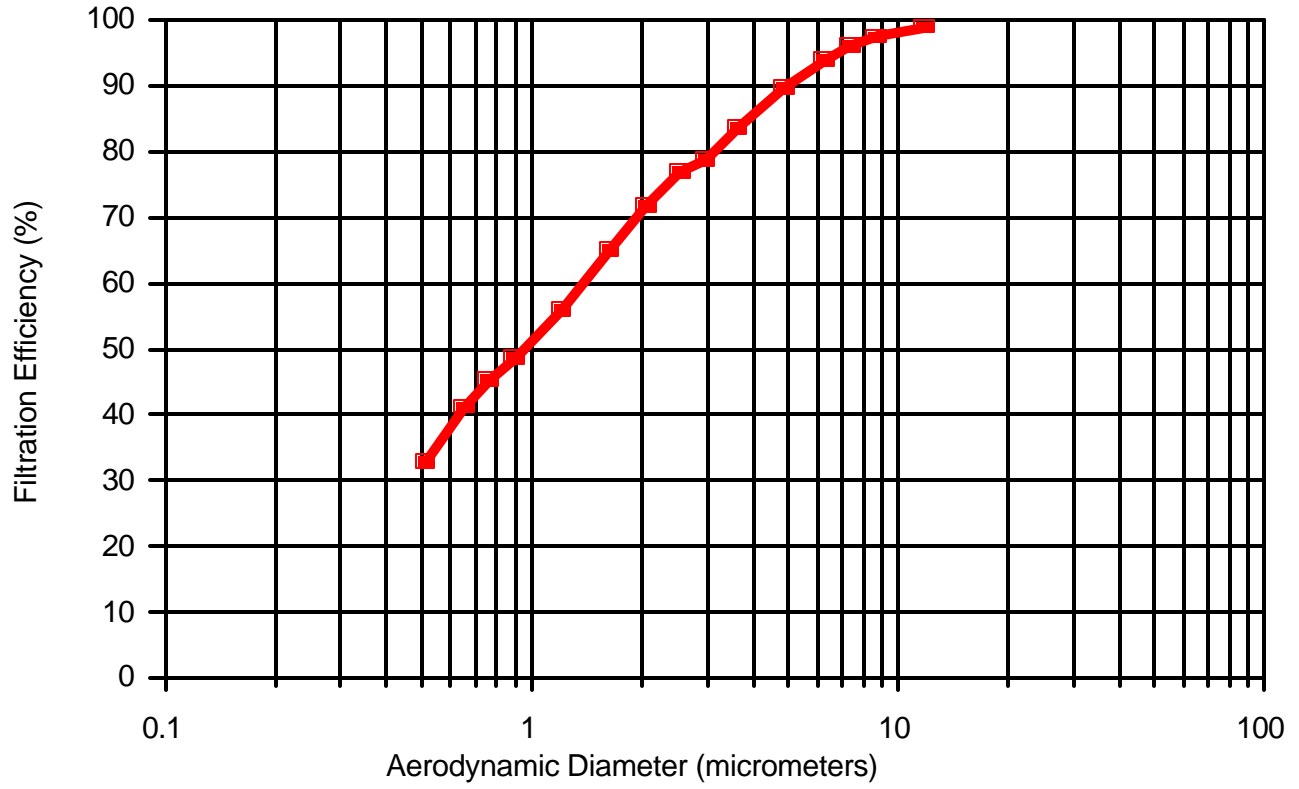

Figure 3. Average of the solid-phase particle removal efficiency curves for the Koch Duo-Pak 650 paint overspray arrestor.

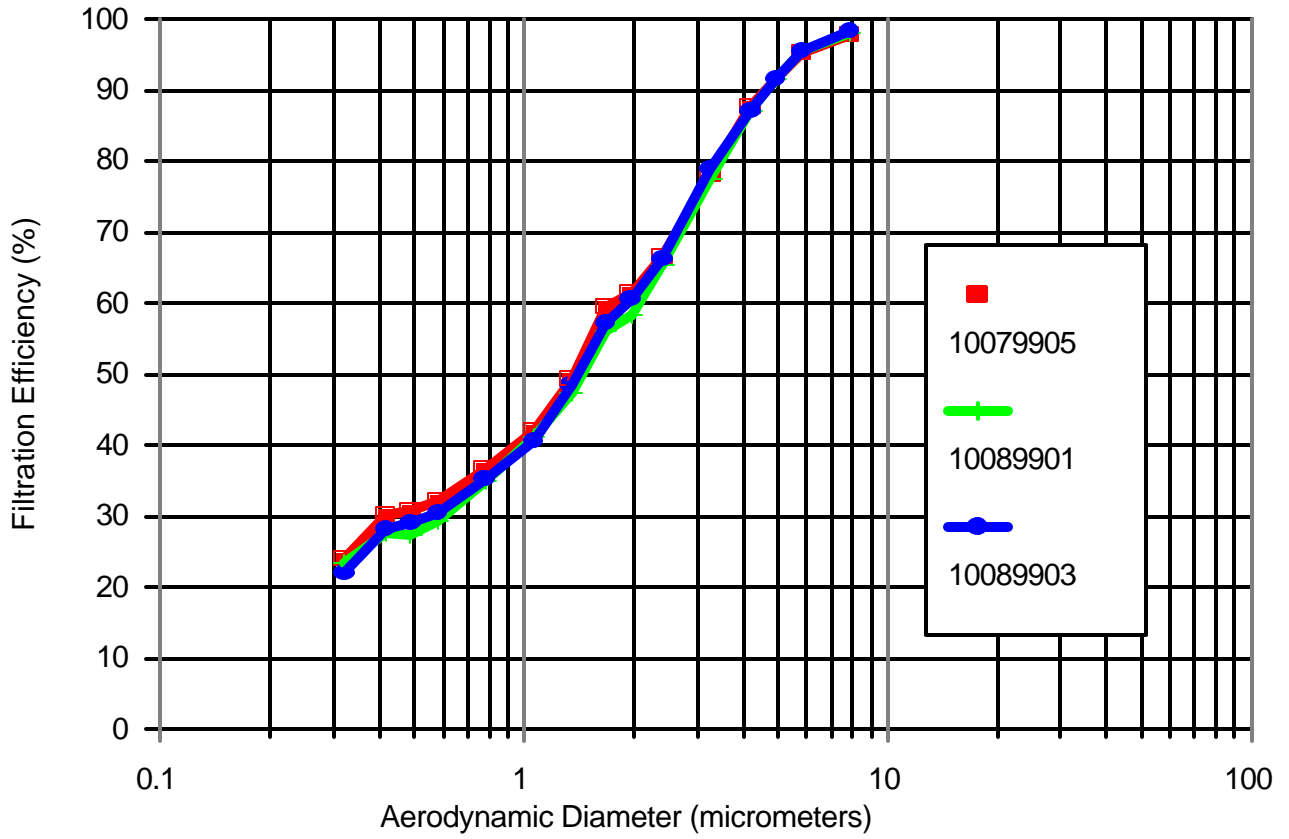

Figure 4. Triplicate liquid-phase particle removal efficiency curves for the Koch Duo-Pak 650 paint overspray arrestor.

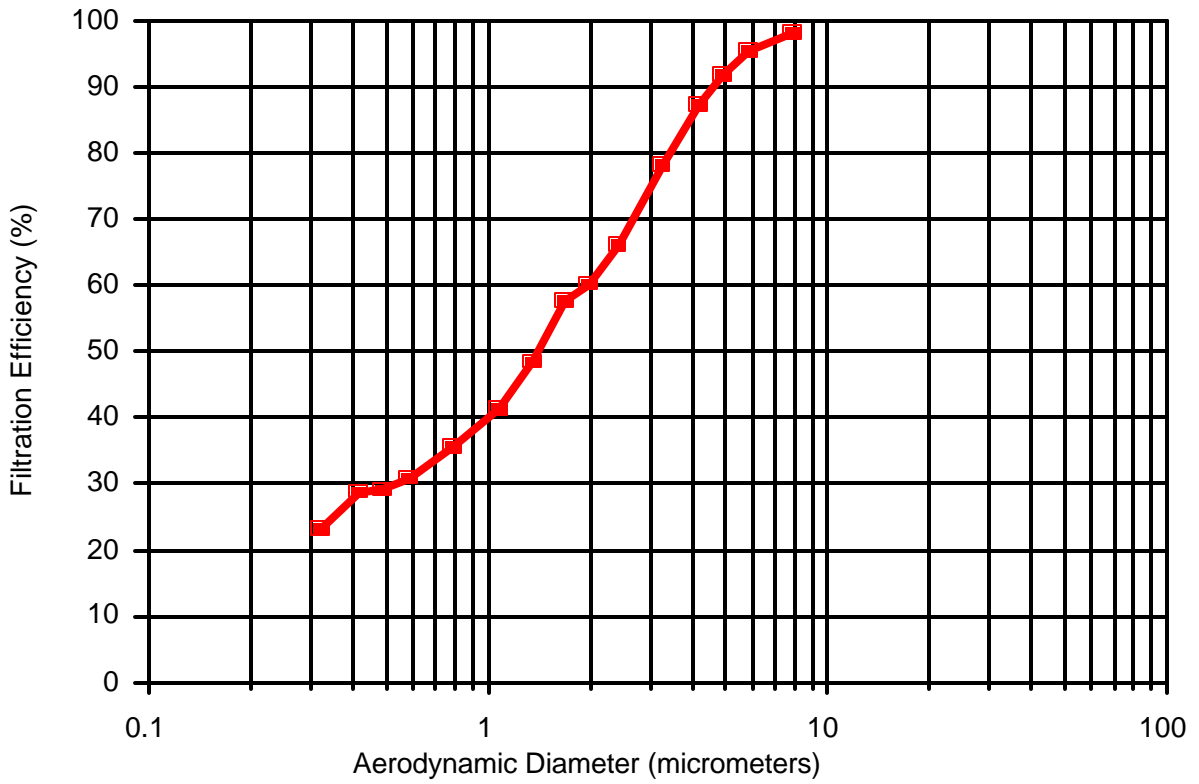

Figure 5. Average of the liquid-phase particle removal efficiency curves for the Koch Duo-Pak 650 paint overspray arrestor.

TABLE 8
SUMMARY OF PRESSURE DROP MEASUREMENTS

Test No.	Initial Pressure Drop (inch H ₂ O)	Initial Pressure Drop (Pa)
10069907	0.08	20
10079901	0.10	25
10079903	0.09	22
10079905	0.10	22
10089901	0.10	22
10089903	0.10	22

Appendix A

DESCRIPTION OF THE TEST RIG AND METHODOLOGY

TEST DUCT

The tests were conducted in RTI's air cleaner test facility (Figure A-1). The test rig's ducting was primarily of 24 x 24 in. (0.61 x 0.61m) cross section and made of 14-gauge stainless steel. The blower is rated at 15 hp (11 kW) with a flow capacity of 3000 cfm (1.4 m³/s) at 13 in. H₂O (3200 Pa). The inlet and outlet filter banks consist of two 24 x 24 x 2 in. (0.61 x 0.61 x 0.05 m) prefilters and two 24 x 24 x 12 in. (0.61 x 0.61 x 0.30 m) high efficiency particulate air (HEPA) filters rated at 2000 cfm (0.9 m³/s) each. The system operates at positive pressure to minimize infiltration of room air.

To mix the test aerosol with the air stream, an orifice plate and mixing baffle were located immediately downstream of the aerosol injection point and upstream of the test arrestor. An identical orifice plate and mixing baffle were added after the 180° bend. The latter downstream orifice served two purposes. It straightened out the flow after going around the bend, and it mixed any aerosol that penetrated the air cleaning device. Mixing the penetrating aerosol with the air stream is necessary to obtain a representative downstream aerosol measurement.

AIRFLOW

Airflow was measured with a 4.00 in. (0.102 m) ID American Society of Mechanical Engineers (ASME) flow nozzle. The nominal velocity through the arrestor was computed by dividing the volumetric flow by the nominal face area of the device. Airflow was manually controlled by a 14 in. (0.36 m) diameter butterfly valve.

OPTICAL PARTICLE COUNTER (OPC)

Aerosol concentrations were measured with a Climet Instruments Model 500 OPC. The OPC has 15 channels covering the range from 0.3 to 10 µm diameter. The OPC uses a laser-light illumination source and has a wide collection angle for the scattered light. The OPC's sampling rate was 0.25 cfm (0.00012 m³/s).

The OPC was equipped to provide a contact closure at the end of each sample and also provides a 15-sec delay in particle counting after each sample. The contact closure was used to control the operation of electromechanical valve actuators in the upstream and downstream sample lines. The 15-sec delay allows time for the new sample to be acquired.

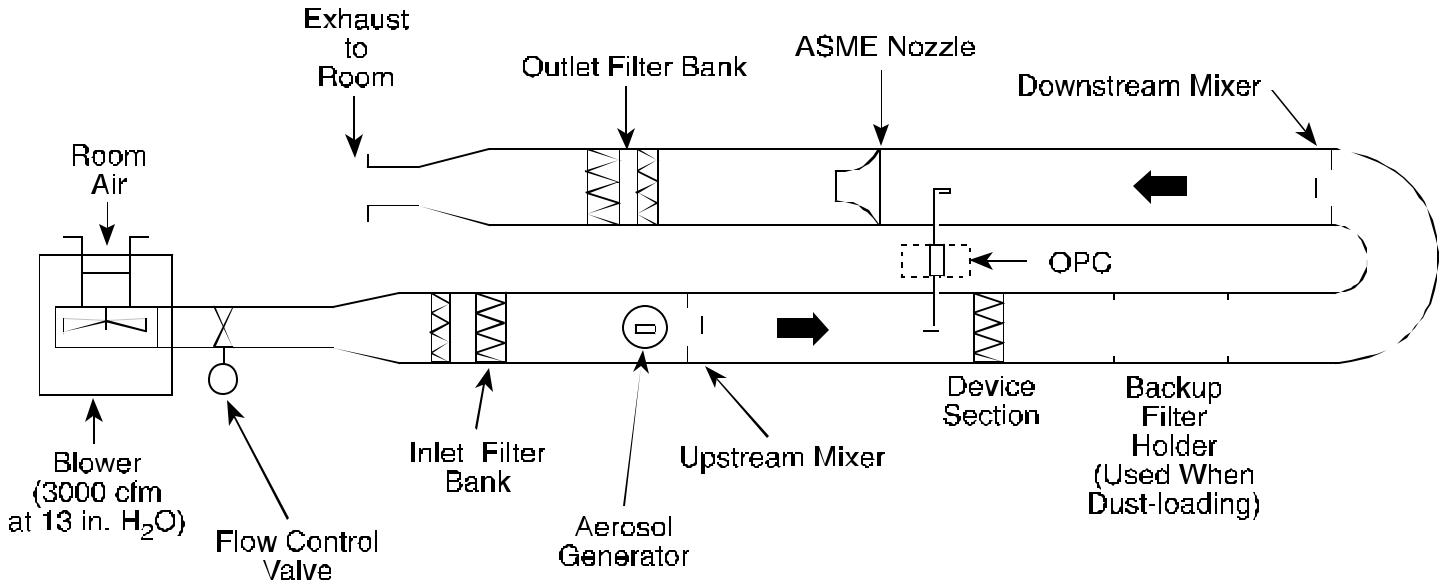

Overview of Test Duct Configuration (Top View)

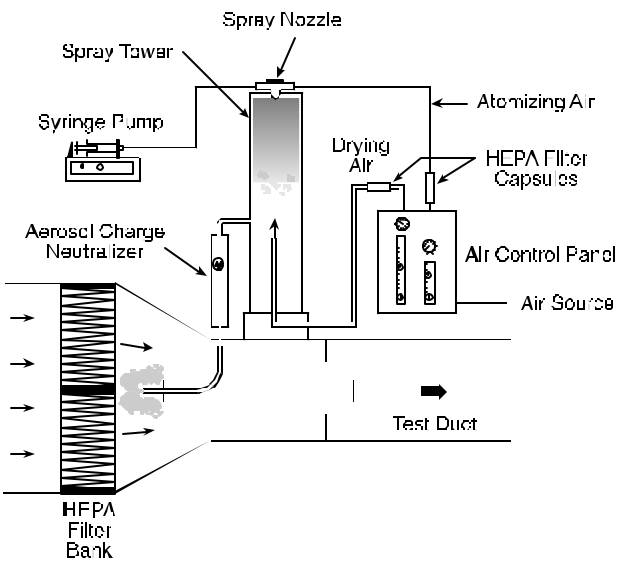

Aerosol Generation System (Side View)

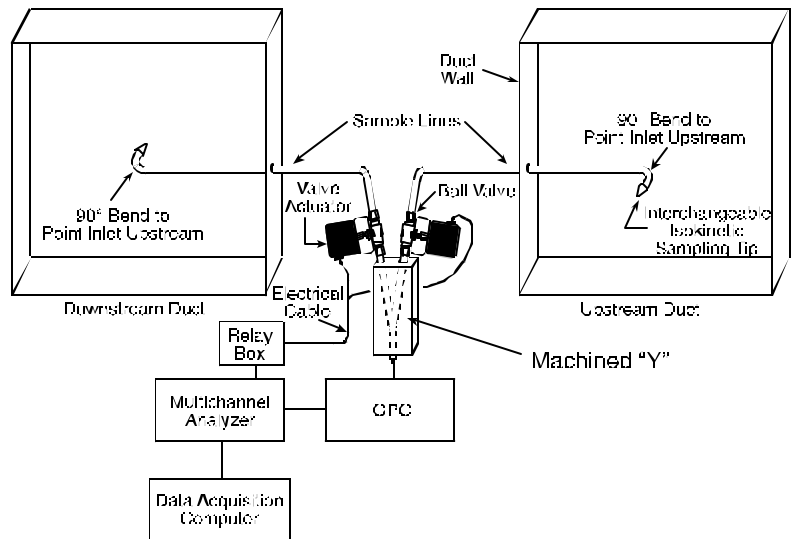

Aerosol Sampling System (End View)

Figure A-1. Schematic illustration of the fractional efficiency test rig.

AEROSOL GENERATION

Two types of challenge aerosols were used: liquid- and solid-phase. The selection of liquid- or solid-phase challenge aerosol particles is important because for some types of paint arrestors significantly different filtration efficiencies will be achieved depending upon the phase of the challenge aerosol particles. (This is due to particle "bounce" associated with solid-phase particles.) The liquid-phase challenge aerosol is oleic acid, a non-toxic, low-volatility liquid. The solid-phase aerosol is potassium chloride (KCl) generated from an aqueous solution. KCl was selected as the solid-phase aerosol because of its relatively high water solubility, high deliquescence humidity (85% relative humidity), known crystalline structure (facilitates complete drying), and low toxicity. The KCl solution was prepared by combining 0.66 lb (300 g) of KCl with 0.035 ft³ (1 L) of distilled water. Both oleic acid and KCl are compatible with accurate measurement by the optical particle counter.

The oleic acid or the KCl solution was nebulized using a two-fluid (air and liquid) air atomizing nozzle (Spray Systems 1/4 J siphon spray nozzle) as illustrated in Figure A-1 (aerosol generation system). The nozzle was positioned at the top of a 12 in. (0.30 m) diameter, 51 in. (1.3 m) tall transparent acrylic spray tower. The tower served two purposes. It allowed the salt droplets to dry by providing an approximate 40 sec mean residence time, and it allowed larger-sized particles (of either KCl or oleic acid) to fall out of the aerosol. After generation, the aerosol passed through a TSI Model 3054 aerosol neutralizer (Kr-85 radioactive source) to neutralize any electrostatic charge on the aerosol (electrostatic charging is an unavoidable consequence of most aerosol-generation methods).

The KCl solution or oleic acid was fed to the atomizing nozzle at 1.2 mL/min by means of a pump. Varying the operating air pressure of the generator allows control of the output aerosol concentration.

AEROSOL SAMPLING SYSTEM

The aerosol sampling lines were 0.55 in. (14 mm) ID stainless steel lines and used gradual bends [radius of curvature = 2.25 in. (57 mm)] when needed. These dimensions were chosen to minimize particle losses in the sample lines. A custom-made "Y" fitting connected the upstream and downstream lines to the OPC. The two branches of the "Y" merged gradually to minimize particle loss in the intersection of the "Y" due to centrifugal or impaction forces.

Immediately above the "Y," electrically actuated ball valves were installed in each branch (Parker Model EA Electro-Mechanical Valve Actuator). The opening and closing of the valves were automatically controlled by the OPC's sequential sampling interface board. The valves take approximately 2 sec to complete an opening or closing maneuver.

Isokinetic sampling nozzles of the appropriate entrance diameter were placed on the ends of the sample probes to maintain isokinetic sampling for all the test flow rates.

TEST PROCEDURES

The aerosol penetration of the test device was calculated from the average of 10 upstream and 10 downstream samples taken sequentially (i.e., one upstream, one downstream, one upstream, one downstream, . . . until 10 each were obtained). This sequential sampling scheme was selected to minimize the effect of aerosol generator variability. Each sample was 2 minutes in duration. The sampling also included background upstream and downstream measurements at the beginning and end of each test. The test sequence was as follows:

1. Warm up OPC and install proper sample tips for isokinetic sampling.
2. Install air cleaner test device and bring test duct to desired flow rate.
3. With the aerosol generator off, obtain one measurement each of the upstream and downstream background particle counts.
4. Turn on the aerosol generator and allow it to run for a minimum of 10 minutes to stabilize.
5. After the stabilization period, obtain 10 upstream and 10 downstream particle counts using a repeated upstream-downstream sampling sequence until 10 each are obtained.
6. Turn off the aerosol generator. Wait 10 minutes, then obtain one additional upstream and downstream background measurement.

CONTROL TESTS

In addition to evaluating the test arrestor, 0 and 100% penetration control tests and a reference filter control test were conducted to ensure that reliable measurements are obtained. The 100% penetration test was a relatively stringent test of the adequacy of the overall duct, sampling, measurement, and aerosol generation system. These tests were performed as normal penetration tests except that the paint arrestor was not used. A perfect system would yield a measured penetration of 1 at all particle sizes. Deviations from 1 can occur due to particle losses in the duct, differences in the degree of aerosol uniformity (i.e., mixing) at the upstream and downstream probes, and differences in particle-transport efficiency in the upstream and downstream sampling lines. Results from the 100% penetration tests were used during data analysis to correct penetration measurements obtained during the arrestor tests.

The 0% penetration test was performed by using a HEPA filter rather than a paint arrestor. This test confirmed the adequacy of the instrument response time and sample line lag. The 0% penetration test was performed on a monthly basis.

The reference filter control test consisted of performing a solid-phase efficiency test on the same filter during each ETV test. The reference filter data from each test were compared to the original, baseline reference filter data to determine if there was any substantial change in the test system between the tests.

DATA ANALYSIS

Nomenclature

- P = Penetration corrected for P_{100} value
- D = Downstream particle count
- D_b = Downstream background count
- U = Upstream particle count
- U_b = Upstream background count
- P_{100} = 100% penetration value determined from the control tests
- Overbar: denotes arithmetic mean of quantity

Analysis of each test involves the following quantities:

- ! P_{100} value for each sizing channel from the blank (no-filter) test,
- ! 2 upstream background values,
- ! 2 downstream background values,
- ! 10 upstream values with aerosol generator on, and
- ! 10 downstream values with aerosol generator on.

Using the values associated with each sizing channel, the penetration associated with each particle sizing channel was calculated as:

$$P = \{(\bar{D} - \bar{D}_b) / (\bar{U} - \bar{U}_b)\} / P_{100} .$$

Filtration efficiency was then calculated as:

$$\text{Filtration Efficiency (\%)} = 100 (1 - P).$$

DEFINITION OF PARTICLE DIAMETER

Over the 0.3 to 10 μm diameter size range, the "aerodynamic" particle diameter is often of more significance than the physical diameter (as measured by the OPC) relative to aerosol filtration and aerosol deposition within the human respiratory tract. The aerodynamic diameter (D_{Aero}) is related to the physical diameter (D_{Physical}) by:

$$D_{\text{Aero}} = D_{\text{Physical}} \sqrt{\frac{\rho_{\text{Particle}}}{\rho_o} \frac{CCF_{\text{Physical}}}{CCF_{\text{Aero}}} \frac{1}{X}}$$

where

ρ_{Particle} is the density of the particle in g/cm^3 .

ρ_o is unit density of 1 g/cm^3 .

CCF_{Physical} is the Cunningham Correction Factor at D_{Physical} .

CCF_{Aero} is the Cunningham Correction Factor at D_{Aero} .

X is the dynamic shape factor.

Note: due to the interdependence of D_{aero} and CCF_{Aero} , the equation is solved iteratively.

For oleic acid droplets having a density of 0.89 g/cm^3 and being spherical ($X = 1$), the aerodynamic diameter will be about 6% smaller than the measured diameter.

KCl has a density of 1.98 g/cm^3 . The KCl particles form from the evaporation of aqueous solution droplets. Because KCl has an inherent cubic crystalline structure, it is expected that the KCl particles will be cubic or relatively compact cubic clusters; however, their actual shape, or range of shapes, is unknown. Because the shape factor is unknown, the shape factor for KCl is assigned a value of 1 and the diameter is termed the "nominal" aerodynamic diameter.

The aerodynamic diameters associated with the 15 OPC sizing channels are tabulated in Table A-1 for oleic acid and KCl. Also listed is the physical diameter size range for each channel based on the manufacturer's calibration curve using monodisperse polystyrene latex (PSL) spheres.

**Table A-1. Physical and Aerodynamic Sizing Channels
for the Calibration and Test Aerosols**

OPC Channel Number	Particle Diameter Size Range (μm)*		
	PSL	OLEIC ACID	KCl
	Physical Diameter	Aerodynamic Diameter	Nominal Aerodynamic Diameter
1	0.3 - 0.4	0.28 - 0.37	0.45 - 0.59
2	0.4 - 0.5	0.37 - 0.47	0.59 - 0.73
3	0.5 - 0.55	0.47 - 0.52	0.73 - 0.80
4	0.55 - 0.7	0.52 - 0.66	0.80 - 1.02
5	0.7 - 1.0	0.66 - 0.94	1.02 - 1.44
6	1.0 - 1.3	0.94 - 1.22	1.44 - 1.86
7	1.3 - 1.6	1.22 - 1.51	1.86 - 2.28
8	1.6 - 2	1.51 - 1.88	2.28 - 2.85
9	2 - 2.2	1.88 - 2.07	2.85 - 3.13
10	2.2 - 3	2.07 - 2.83	3.13 - 4.25
11	3 - 4	2.83 - 3.77	4.25 - 5.66
12	4 - 5	3.77 - 4.71	5.66 - 7.07
13	5 - 5.5	4.71 - 5.18	7.07 - 7.77
14	5.5 - 7	5.18 - 6.60	7.77 - 9.88
15	7 - 10	6.60 - 9.43	9.88 - 14.1

*The particle diameter size ranges are defined as greater than the indicated lower limit and less than or equal to the indicated upper limit.

APPENDIX B
Certificates of Calibration

Certificate of Traceability

8500D-II THERMOANEMOMETER

Model No. 8500D-II Serial No. 3810 Part No. 634493200

Certificate Number: 1946 Date: 28-Oct-88 P.O. 00328 Order/RMA: 104638
 Customer Number:

*Certification Standards information
 The following standards and equipment were used as references for this calibration.*

Tested By	Date Tested	Inst. No.	Cal. Due	MIST Test Numbers
LOZADA	10/23/88	747	4/9/00	259340; 257602; 258905; 258659; 262222; 811255622
		746	4/3/00	811259522; 811280176;
		922	5/9/00	538723847-58 ;
		881	11/10/88	811257079 ; 247770 ; 253406 ; 811255474 ; 253669 U3N22730C ; Chem. Const. ; 254227 ; 811256730 ; 811251992 ; 251971 ; 811251741 ; 811253662 ; 811256210 ; 811802 ;
		857	5/9/00	536259947-58 ; ;
		784	3/18/09	
		888	2/21/00	811255765 ; 251971 ; 811259304-88 ; 811257773 ; 255216 ; ;
		359	11/12/88	P-8531A ; P-8531B ; 38128 ; 25-1160 ; 255332 ;
		326	2/9/90	P-8631A ; P-8631B ; 38120 ; 254160 ; 255009 ;
		319	11/12/88	P-8531A ; P-8531B ; 38128 ; 25-1160 ; 255332 ;
		321	12/11/88	856257123-56 ; ;

Alnor Instrument Company hereby certifies that the above designated equipment was found to meet or exceed manufacturing specifications. Their calibration is traceable to the National Institute of Standards and Technology (NIST) or related physical constants. This policy and procedures used comply with MIL-STD-46550A. This certificate shall not be reproduced except in full, without the written consent of Alnor.

Reviewed by: 

28-Oct-88

Date



Alnor Instrument Company
 7555 N. Under Avenue, Skokie, IL 60077
 Tel. 847-577-3500 Fax. 847-677-3539



FILE NO. 040FB:001-19
PAGE 1 OF 1

LETTER OF CERTIFICATION
LAMINAR FLOW ELEMENT

CUSTOMER NAME: RESEARCH TRIANGLE INST
CUSTOMER ORDER NUMBER: 00161
MERIAM ORDER NUMBER: 772900

Meriam Instrument certifies that the completed LFE unit has been calibrated and correlated at several points of flow rate using a Meriam Standard, which is controlled per the calibration system requirements of ANSI Z540-1 and traceable to the National Institute of Standards and Technology. The collective uncertainty of the measurement standards has a 1:1 ratio to the acceptable tolerance for the flow rate being calibrated.

The total rss uncertainty of the completed laminar flow unit is +/- .72 % of reading.

CUSTOMER ID NO.: 013716

MODEL NO.: 50MH10-8 SERIAL NO.: 758860-K1

FLOW CURVE/TABLE NO.: 30624

DATE OF CALIBRATION 11-11-1998 BY GEORGE ROBOTKAY

AS RECEIVED CONDITION: In Tolerance Out of Tolerance NA

AS LEFT CONDITION : In Tolerance Out of Tolerance NA

CALIBRATION INTERVAL: TO BE DETERMINED BY CUSTOMER BASED ON USAGE OF LFE.

FLOW STANDARD SERIAL NO.	DATE OF LAST CAL	DATE OF NEXT CAL
WMMC2-6	JAN 1998	JAN 1999

The LFE unit listed hereon has been successfully calibrated in accordance with Meriam Instrument Procedure A-35822.

Michael V. [Signature]
QUALITY ASSURANCE INSPECTOR
MERIAM INSTRUMENT

Jack Weigand [Signature]
QUALITY ASSURANCE MANAGER
MERIAM INSTRUMENT

US EPA ARCHIVE DOCUMENT

CLIMET INSTRUMENTS COMPANY

1320 WEST COLTON AVE., REDLANDS, CA 92374 • PHONE: (909) 793-2788 • FAX: (909) 793-1738

CERTIFICATE OF CALIBRATION

INSTRUMENT CALIBRATED

MODEL: CT-500 aerosol particle counter, S/N 97-1821

CONTROL NUMBER: 61624001

DATE CALIBRATED: 04/03/99 NEXT CALIBRATION: 04/03/00

RECOMMENDED CALIBRATION INTERVAL: 12 months

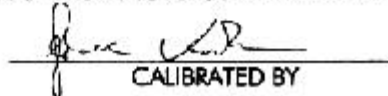
CALIBRATED BY

APPROVED BY

TRACEABILITY STATEMENT

This instrument has been calibrated in accordance with ISO 10012-1/ANSI Z540-1 (which replaces MIL-STD-45662A) and relevant portions of Federal Standards 209, ASTM F-50, F322, and F328.

Temperature and Relative Humidity are not controlled during calibration because of the wide operating range of the instrument. The operating limits of this instrument are:

TEMPERATURE: 30°F TO 122°F
HUMIDITY: 0-100%, non-condensing

All test equipment used in the calibration of Climet Instruments' products is calibrated at six-month intervals by an outside calibration service. Calibration certificates for each piece of test equipment are on file at Climet; copies will be supplied if requested.

Calibration traceability to a National Measurement Standard (NMS) is established by using mono-disperse latex spheres as a calibration standard. These spheres are sized by methods traceable, by lot number, to the National Institute of Science and Technology.

APPENDIX C
Fractional Efficiency Data Sheets

Key to notation used in the following tables:

Diam.:	Particle Diameter (µm)
Geo.:	Geometric
U. Bckgrnd:	The upstream background particle counts measured with the aerosol generator off.
Upstream:	The upstream particle counts measured with the aerosol generator on.
D. Bckgrnd:	The downstream background particle counts measured with the aerosol generator off.
Downstream:	The downstream particle counts measured with the aerosol generator on.
Meas. Penetration:	The penetration computed as:

$$\text{Meas. Penetration} = \frac{(\text{Downstream} \ \& \ D. \ \text{Bckgrnd})}{(\text{Upstream} \ \& \ U. \ \text{Bckgrnd})}$$

P100 Correction Values:	Penetration values measured with no filter in the test section. These values are used to correct subsequent penetration measurements for particle losses within the test duct and sampling system.
Corrected Penetration:	The measured penetration corrected by the P100 values:

$$\text{Corrected Penetration} = \frac{\text{Meas. Penetration}}{\text{P100 Correction Values}}$$

Corrected Efficiency (%):	100 x (1 - Corrected Penetration)
DQO	Data Quality Objective

Test No. 10069904
 No Filter
 Solid-Phase

Particle Counts per Indicated OPC Channel (1-Minute Samples @ 7.1 L/min)

OPC Channel Number	1	2	3	4	5	6	7	8	9	10	11	12	13	14	15
Min. Diam. (um)	0.45	0.59	0.73	0.80	1.02	1.44	1.86	2.28	2.85	3.13	4.25	5.66	7.07	7.77	9.88
Max. Diam. (um)	0.59	0.73	0.80	1.02	1.44	1.86	2.28	2.85	3.13	4.25	5.66	7.07	7.77	9.88	14.10
Geo. Mean Diam (um)	0.52	0.66	0.77	0.90	1.21	1.64	2.06	2.55	2.98	3.65	4.91	6.33	7.41	8.76	11.81

ENTER DATA BELOW

U. Bckgrnd	1 Dif	10-06-1999	11:51:45	0.2 CF	0	0	0	0	0	0	0	0	0	0	0	0			
U. Bckgrnd	1 Dif	10-06-1999	11:53:51	0.2 CF	0	0	0	0	0	0	0	0	0	0	0	0			
Upstream	1 Dif	10-06-1999	11:58:03	0.2 CF	9807	7900	2178	6065	11818	4717	3059	2150	1205	3484	2295	1107	477	913	683
Upstream	1 Dif	10-06-1999	12:00:09	0.2 CF	9937	7911	2085	5942	11534	4719	3014	2274	1113	3619	2301	1212	530	948	690
Upstream	1 Dif	10-06-1999	12:02:15	0.2 CF	9973	8010	2108	6096	11425	4529	2823	2116	1245	3534	2358	1198	471	965	698
Upstream	1 Dif	10-06-1999	12:04:21	0.2 CF	9817	7824	2096	5854	11326	4594	2899	2236	1165	3487	2266	1192	491	940	755
Upstream	1 Dif	10-06-1999	12:06:27	0.2 CF	9919	7975	2121	6029	11665	4691	2938	2178	1155	3535	2287	1189	499	940	716
Upstream	1 Dif	10-06-1999	12:08:33	0.2 CF	9965	7945	2107	6091	11655	4677	3009	2241	1142	3639	2209	1226	526	957	726
Upstream	1 Dif	10-06-1999	12:10:39	0.2 CF	9975	7839	2095	5816	11733	4685	2791	2209	1094	3588	2290	1165	492	942	701
Upstream	1 Dif	10-06-1999	12:12:45	0.2 CF	9926	8016	2142	5997	11646	4634	2787	2216	1149	3389	2256	1146	477	958	706
Upstream	1 Dif	10-06-1999	12:14:51	0.2 CF	9975	8141	2215	5953	11674	4800	2903	2260	1133	3498	2237	1138	497	893	705
Upstream	1 Dif	10-06-1999	12:16:57	0.2 CF	9953	8004	2014	5857	11509	4629	2878	2164	1129	3488	2237	1201	477	920	721
U. Bckgrnd	1 Dif	10-06-1999	12:25:21	0.2 CF	1	0	0	0	0	0	0	0	0	0	0	0	0	0	0
U. Bckgrnd	1 Dif	10-06-1999	12:27:27	0.2 CF	0	0	0	0	0	0	0	0	0	0	0	0	0	0	0

ENTER DATA BELOW

D. Bckgrnd	2 Dif	10-06-1999	11:52:48	0.2 CF	4	0	0	0	0	0	0	0	0	0	0	0	0	0	0
Downstream	2 Dif	10-06-1999	11:59:06	0.2 CF	9793	7877	2142	5886	11802	4702	3117	2245	1171	3509	2134	1154	471	781	537
Downstream	2 Dif	10-06-1999	12:01:12	0.2 CF	9896	7814	2059	5946	11319	4667	2902	2099	1162	3514	2228	1169	451	849	629
Downstream	2 Dif	10-06-1999	12:03:18	0.2 CF	9870	7827	2118	5838	11394	4579	2905	2193	1131	3477	2222	1188	482	878	619
Downstream	2 Dif	10-06-1999	12:05:24	0.2 CF	9955	7938	2114	5941	11420	4651	2867	2178	1100	3431	2201	1104	476	839	565
Downstream	2 Dif	10-06-1999	12:07:30	0.2 CF	9914	7949	2218	6023	11576	4748	2990	2180	1175	3548	2272	1169	439	835	636
Downstream	2 Dif	10-06-1999	12:09:36	0.2 CF	9707	7931	2154	5961	11403	4774	2937	2182	1121	3637	2296	1134	482	794	607
Downstream	2 Dif	10-06-1999	12:11:42	0.2 CF	9700	7981	2137	6015	11713	4782	2945	2176	1170	3626	2173	1139	456	812	610
Downstream	2 Dif	10-06-1999	12:13:48	0.2 CF	9777	8150	2139	5966	11618	4661	2888	2161	1190	3552	2182	1116	464	799	542
Downstream	2 Dif	10-06-1999	12:15:54	0.2 CF	9846	7982	2147	6046	11780	4628	2977	2177	1157	3471	2297	1138	462	880	596
Downstream	2 Dif	10-06-1999	12:18:00	0.2 CF	10018	8023	2093	5933	11429	4607	2808	2037	1149	3480	2247	1105	504	814	596
D. Bckgrnd	2 Dif	10-06-1999	12:26:24	0.2 CF	3	1	0	0	0	0	0	0	0	0	0	0	0	0	0

Meas. Penetration	0.99	1.00	1.01	1.00	1.00	1.00	1.01	0.98	1.00	1.00	0.98	0.97	0.95	0.88	0.84
P100 correction values	1.00	1.00	1.00	1.00	1.00	1.00	1.00	1.00	1.00	1.00	1.00	1.00	1.00	1.00	1.00
Corrected Penetration	0.99	1.00	1.01	1.00	1.00	1.00	1.01	0.98	1.00	1.00	0.98	0.97	0.95	0.88	0.84
Corrected Efficiency (%)	1	0	-1	0	0	0	-1	2	0	0	2	3	5	12	16

Data Acceptance Criteria:

Total Challenge Counts for Each Channel:	99247	79565	21161	59700	115985	46675	29101	22044	11530	35261	22736	11774	4937	9376	7101
Data Quality Objective:	> 500	> 500	> 500	> 500	> 500	> 500	> 500	> 500	> 500	> 500	> 500	> 500	> 500	> 500	> 500
Does this meet DQO:	Yes	Yes	Yes	Yes	Yes	Yes	Yes	Yes	Yes	Yes	Yes	Yes	Yes	Yes	Yes

Standard Deviation of Penetration for Each Channel :	0.01	0.02	0.03	0.02	0.02	0.02	0.04	0.03	0.05	0.03	0.03	0.04	0.05	0.04	0.05
Data Quality Objective:	<0.10	<0.10	<0.10	<0.10	<0.10	<0.10	<0.10	<0.10	<0.10	<0.30	<0.30	<0.30	<0.30	<0.30	<0.30
Does this meet DQO:	Yes	Yes	Yes	Yes	Yes	Yes	Yes	Yes	Yes	Yes	Yes	Yes	Yes	Yes	Yes

Maximum observed particle concentration (#/cc): 10.6
 Data Quality Objective: max. allowable conc. (#/cc): < 14
 Does this meet the DQO: Yes, (applies to all channels)

Test No. 10069905
Reference
Solid-Phase

Particle Counts per Indicated OPC Channel (1-Minute Samples @ 7.1 L/min)

OPC Channel Number	1	2	3	4	5	6	7	8	9	10	11	12	13	14	15
Min. Diam. (um)	0.45	0.59	0.73	0.80	1.02	1.44	1.86	2.28	2.85	3.13	4.25	5.66	7.07	7.77	9.88
Max. Diam. (um)	0.59	0.73	0.80	1.02	1.44	1.86	2.28	2.85	3.13	4.25	5.66	7.07	7.77	9.88	14.10
Geo. Mean Diam (um)	0.52	0.66	0.77	0.90	1.21	1.64	2.06	2.55	2.98	3.65	4.91	6.33	7.41	8.76	11.81

ENTER DATA BELOW

U. Bckgrnd	1 Df	10-06-1999	13:22:39	0.2 CF	2	0	0	0	0	0	0	0	0	0	0	0			
U. Bckgrnd	1 Df	10-06-1999	13:24:45	0.2 CF	3	0	0	0	0	0	0	0	0	0	0	0			
Upstream	1 Df	10-06-1999	13:28:57	0.2 CF	9755	7575	2068	5839	11331	4382	2899	2117	1182	3416	2245	1149	479	921	690
Upstream	1 Df	10-06-1999	13:31:03	0.2 CF	9738	7980	2051	5941	11416	4733	2817	2191	1168	3519	2238	1177	493	950	719
Upstream	1 Df	10-06-1999	13:33:09	0.2 CF	10129	8142	2151	6017	11831	4748	3021	2293	1234	3596	2267	1252	495	990	728
Upstream	1 Df	10-06-1999	13:35:15	0.2 CF	9844	8004	2126	5950	11698	4640	3020	2166	1096	3515	2253	1234	499	919	697
Upstream	1 Df	10-06-1999	13:37:21	0.2 CF	9995	7948	2147	6132	11821	4784	3010	2233	1221	3524	2262	1228	501	959	710
Upstream	1 Df	10-06-1999	13:39:27	0.2 CF	10036	8313	2176	6186	11990	4943	2978	2234	1162	3542	2373	1178	464	930	767
Upstream	1 Df	10-06-1999	13:41:33	0.2 CF	9910	8108	2148	5963	11780	4725	2926	2258	1178	3455	2428	1228	479	934	677
Upstream	1 Df	10-06-1999	13:43:39	0.2 CF	10112	7905	2104	6064	11485	4643	2901	2122	1150	3481	2304	1152	449	959	707
Upstream	1 Df	10-06-1999	13:45:45	0.2 CF	9965	8140	2201	6039	11750	4867	2927	2264	1232	3577	2282	1164	496	979	712
Upstream	1 Df	10-06-1999	13:47:51	0.2 CF	9985	7844	2221	6040	11782	4769	3000	2191	1142	3595	2309	1205	521	941	719
U. Bckgrnd	1 Df	10-06-1999	13:58:21	0.2 CF	1	0	0	0	0	0	0	0	0	0	0	0	0	0	0
U. Bckgrnd	1 Df	10-06-1999	14:00:27	0.2 CF	0	0	0	0	0	0	0	0	0	0	0	0	0	0	0

ENTER DATA BELOW

D. Bckgrnd	2 Df	10-06-1999	13:23:42	0.2 CF	0	0	0	0	0	0	0	0	0	0	0	0	0	0	0
Downstream	2 Df	10-06-1999	13:30:00	0.2 CF	9826	7862	1931	5874	11167	4467	2726	1917	1048	2956	1767	778	228	321	123
Downstream	2 Df	10-06-1999	13:32:06	0.2 CF	9714	7804	2030	5740	11117	4472	2765	1926	1058	3088	1787	761	254	353	147
Downstream	2 Df	10-06-1999	13:34:12	0.2 CF	10111	8042	2084	5813	11092	4551	2802	2083	1069	3024	1654	720	232	306	145
Downstream	2 Df	10-06-1999	13:36:18	0.2 CF	9951	7861	2119	5888	11123	4436	2748	1965	1095	3072	1650	711	228	302	142
Downstream	2 Df	10-06-1999	13:38:24	0.2 CF	9886	7969	2137	5838	11443	4611	2807	2003	1005	3120	1711	750	260	324	121
Downstream	2 Df	10-06-1999	13:40:30	0.2 CF	9896	7937	2123	5880	11469	4519	2763	2075	1079	3020	1792	731	218	307	128
Downstream	2 Df	10-06-1999	13:42:36	0.2 CF	9859	7836	2089	5803	11207	4494	2788	2003	1091	3080	1668	732	234	336	161
Downstream	2 Df	10-06-1999	13:44:42	0.2 CF	10095	7914	2116	6012	11376	4620	2827	1959	1026	3140	1779	728	230	319	120
Downstream	2 Df	10-06-1999	13:46:48	0.2 CF	9804	7759	2018	5800	11317	4528	2717	2029	1079	3047	1753	679	256	329	136
Downstream	2 Df	10-06-1999	13:48:54	0.2 CF	10169	8044	2156	5898	11453	4722	2846	2062	1055	3125	1695	716	244	335	112
D. Bckgrnd	2 Df	10-06-1999	13:59:24	0.2 CF	0	0	0	0	0	0	0	0	0	0	0	0	0	0	0

Meas. Penetration	1.00	0.99	0.97	0.97	0.96	0.96	0.94	0.91	0.90	0.87	0.75	0.61	0.49	0.34	0.19
P100 correction values	0.99	1.00	1.01	1.00	1.00	1.00	1.01	0.98	1.00	1.00	0.98	0.97	0.95	0.88	0.84
Corrected Penetration	1.01	0.99	0.97	0.98	0.97	0.96	0.93	0.92	0.90	0.87	0.77	0.63	0.52	0.39	0.22
Corrected Efficiency (%)	-1	1	3	2	3	4	7	8	10	13	23	37	48	61	78

Data Acceptance Criteria:

Total Challenge Counts for Each Channel:	99469	79959	21393	60171	116884	47234	29499	22069	11765	35220	22961	11967	4876	9482	7126
Data Quality Objective:	> 500	> 500	> 500	> 500	> 500	> 500	> 500	> 500	> 500	> 500	> 500	> 500	> 500	> 500	> 500
Does this meet DQO:	Yes	Yes	Yes	Yes	Yes	Yes	Yes	Yes	Yes	Yes	Yes	Yes	Yes	Yes	Yes

Standard Deviation of Penetration for Each Channel :	0.02	0.03	0.04	0.02	0.02	0.04	0.03	0.04	0.04	0.02	0.03	0.03	0.04	0.02	0.02
Data Quality Objective:	<0.10	<0.10	<0.10	<0.10	<0.10	<0.10	<0.10	<0.10	<0.10	<0.10	<0.30	<0.30	<0.30	<0.30	<0.30
Does this meet DQO:	Yes	Yes	Yes	Yes	Yes	Yes	Yes	Yes	Yes	Yes	Yes	Yes	Yes	Yes	Yes

Maximum observed particle concentration (#/cc): 10.8
Data Quality Objective: max. allowable conc. (#/cc): < 14
Does this meet the DQO: Yes, (applies to all channels)

Test No. 10069906
 No Filter
 Solid-Phase

Particle Counts per Indicated OPC Channel (1-Minute Samples @ 7.1 L/min)

OPC Channel Number	1	2	3	4	5	6	7	8	9	10	11	12	13	14	15
Min. Diam. (um)	0.45	0.59	0.73	0.80	1.02	1.44	1.86	2.28	2.85	3.13	4.25	5.66	7.07	7.77	9.88
Max. Diam. (um)	0.59	0.73	0.80	1.02	1.44	1.86	2.28	2.85	3.13	4.25	5.66	7.07	7.77	9.88	14.10
Geo. Mean Diam (um)	0.52	0.66	0.77	0.90	1.21	1.64	2.06	2.55	2.98	3.65	4.91	6.33	7.41	8.76	11.81

ENTER DATA BELOW

U. Bckgrnd	1 Dif	10-06-1999 14:15:09	0.2 CF	1	0	0	0	0	0	1	0	0	0	1	2	0	0	2
U. Bckgrnd	1 Dif	10-06-1999 14:17:15	0.2 CF	1	0	0	0	0	0	0	0	0	0	0	0	0	0	0
Upstream	1 Dif	10-06-1999 14:22:33	0.2 CF	9615	7908	2108	5827	11428	4593	2799	2165	1142	3383	2180	1128	470	919	722
Upstream	1 Dif	10-06-1999 14:24:39	0.2 CF	9801	8003	2152	6022	11479	4609	2866	2120	1154	3493	2325	1151	493	931	745
Upstream	1 Dif	10-06-1999 14:26:45	0.2 CF	10009	7873	2131	6078	11551	4655	2928	2157	1117	3494	2297	1208	467	908	724
Upstream	1 Dif	10-06-1999 14:28:51	0.2 CF	10144	8182	2072	6147	11795	4694	2817	2197	1212	3468	2258	1180	501	924	695
Upstream	1 Dif	10-06-1999 14:30:57	0.2 CF	9990	8134	2157	6225	11803	4813	2986	2218	1168	3540	2256	1186	518	945	717
Upstream	1 Dif	10-06-1999 14:33:03	0.2 CF	10033	8259	2212	5999	11817	4688	2818	2262	1133	3536	2223	1179	496	949	750
Upstream	1 Dif	10-06-1999 14:35:09	0.2 CF	10210	8287	2171	6241	11936	4833	2947	2238	1197	3616	2275	1285	452	925	725
Upstream	1 Dif	10-06-1999 14:37:15	0.2 CF	10169	8161	2229	6102	12129	4820	2933	2379	1111	3576	2289	1149	467	950	657
Upstream	1 Dif	10-06-1999 14:39:21	0.2 CF	10320	8308	2130	6327	12079	4943	2992	2245	1183	3676	2367	1219	482	929	713
Upstream	1 Dif	10-06-1999 14:41:27	0.2 CF	10061	8137	2019	6122	11731	4747	2878	2239	1182	3552	2316	1239	506	923	724
U. Bckgrnd	1 Dif	10-06-1999 14:50:55	0.2 CF	2	0	0	0	0	0	0	0	0	0	0	0	0	0	0
U. Bckgrnd	1 Dif	10-06-1999 14:53:01	0.2 CF	0	0	0	0	0	0	0	0	0	0	0	0	0	0	0

ENTER DATA BELOW

D. Bckgrnd	2 Dif	10-06-1999 14:16:12	0.2 CF	1	0	0	0	0	0	0	0	0	0	0	0	0	0	0
Downstream	2 Dif	10-06-1999 14:23:36	0.2 CF	9641	7786	2062	5779	11228	4471	2781	2091	1145	3335	2198	1133	418	825	552
Downstream	2 Dif	10-06-1999 14:25:42	0.2 CF	9915	7973	2138	5877	11651	4676	2998	2111	1128	3476	2251	1097	504	831	599
Downstream	2 Dif	10-06-1999 14:27:48	0.2 CF	9889	8059	2179	6030	11638	4685	2940	2211	1124	3551	2175	1134	474	815	601
Downstream	2 Dif	10-06-1999 14:29:54	0.2 CF	9953	8183	2118	6031	11569	4732	2885	2229	1148	3519	2264	1174	454	788	610
Downstream	2 Dif	10-06-1999 14:32:00	0.2 CF	9820	8126	2215	5931	11607	4695	2908	2162	1204	3635	2259	1178	442	863	603
Downstream	2 Dif	10-06-1999 14:34:06	0.2 CF	10100	8282	2147	6136	11755	4751	2959	2201	1108	3535	2231	1187	452	822	620
Downstream	2 Dif	10-06-1999 14:36:12	0.2 CF	10160	8330	2257	6202	12003	4908	2959	2314	1222	3567	2352	1119	464	841	566
Downstream	2 Dif	10-06-1999 14:38:18	0.2 CF	10398	8280	2197	6339	12100	4841	3139	2281	1202	3633	2276	1128	458	815	595
Downstream	2 Dif	10-06-1999 14:40:24	0.2 CF	10203	8157	2182	6213	12059	4841	2901	2169	1142	3541	2182	1098	443	817	567
Downstream	2 Dif	10-06-1999 14:42:30	0.2 CF	10031	8131	2075	6247	11846	4709	2945	2148	1158	3455	2286	1114	470	842	635
D. Bckgrnd	2 Dif	10-06-1999 14:51:58	0.2 CF	1	0	0	0	0	0	0	0	0	0	0	0	0	0	0

Meas. Penetration	1.00	1.00	1.01	1.00	1.00	1.00	1.02	0.99	1.00	1.00	0.99	0.95	0.94	0.89	0.83
P100 correction values	1.00	1.00	1.00	1.00	1.00	1.00	1.00	1.00	1.00	1.00	1.00	1.00	1.00	1.00	1.00
Corrected Penetration	1.00	1.00	1.01	1.00	1.00	1.00	1.02	0.99	1.00	1.00	0.99	0.95	0.94	0.89	0.83
Corrected Efficiency (%)	0	0	-1	0	0	0	-2	1	0	0	1	5	6	11	17

Data Acceptance Criteria:

Total Challenge Counts for Each Channel:	100352	81252	21381	61090	117748	47395	28964	22220	11599	35334	22786	11924	4852	9303	7172
Data Quality Objective:	> 500	> 500	> 500	> 500	> 500	> 500	> 500	> 500	> 500	> 500	> 500	> 500	> 500	> 500	> 500
Does this meet DQO:	Yes	Yes	Yes	Yes	Yes	Yes	Yes	Yes	Yes	Yes	Yes	Yes	Yes	Yes	Yes

Standard Deviation of Penetration for Each Channel :	0.03	0.03	0.04	0.04	0.03	0.03	0.04	0.04	0.04	0.04	0.03	0.03	0.05	0.06	0.03	0.05
Data Quality Objective:	<0.10	<0.10	<0.10	<0.10	<0.10	<0.10	<0.10	<0.10	<0.10	<0.10	<0.30	<0.30	<0.30	<0.30	<0.30	<0.30
Does this meet DQO:	Yes	Yes	Yes	Yes	Yes	Yes	Yes	Yes	Yes	Yes	Yes	Yes	Yes	Yes	Yes	Yes

Maximum observed particle concentration (#/cc): 10.9
 Data Quality Objective: max. allowable conc. (#/cc): < 14
 Does this meet the DQO: Yes, (applies to all channels)

Test No. 10069907
 Arrestor
 Solid-Phase

Particle Counts per Indicated OPC Channel (1-Minute Samples @ 7.1 L/min)

OPC Channel Number	1	2	3	4	5	6	7	8	9	10	11	12	13	14	15
Min. Diam. (um)	0.45	0.59	0.73	0.80	1.02	1.44	1.86	2.28	2.85	3.13	4.25	5.66	7.07	7.77	9.88
Max. Diam. (um)	0.59	0.73	0.80	1.02	1.44	1.86	2.28	2.85	3.13	4.25	5.66	7.07	7.77	9.88	14.10
Geo. Mean Diam (um)	0.52	0.66	0.77	0.90	1.21	1.64	2.06	2.55	2.98	3.65	4.91	6.33	7.41	8.76	11.81

ENTER DATA BELOW

U. Bckgrnd	1 Dif	10-06-1999 15:04:31	0.2 CF	0	0	0	0	0	0	0	0	0	0	0	0	0		
U. Bckgrnd	1 Dif	10-06-1999 15:06:37	0.2 CF	3	1	0	0	0	0	0	0	0	0	0	0	0		
Upstream	1 Dif	10-06-1999 15:10:49	0.2 CF	9916	7809	2115	6096	11569	4732	2876	2156	1132	3451	2177	1129	447	907	736
Upstream	1 Dif	10-06-1999 15:12:55	0.2 CF	9734	8004	2157	6068	11413	4534	2835	2149	1102	3503	2221	1182	504	974	728
Upstream	1 Dif	10-06-1999 15:15:01	0.2 CF	9963	7915	2097	5954	11462	4622	2814	2113	1179	3410	2238	1143	455	912	687
Upstream	1 Dif	10-06-1999 15:17:07	0.2 CF	9990	8020	2032	6028	11681	4795	2892	2159	1188	3477	2258	1130	474	887	710
Upstream	1 Dif	10-06-1999 15:19:13	0.2 CF	9672	7823	2141	5952	11495	4542	2894	2165	1143	3464	2238	1249	506	973	724
Upstream	1 Dif	10-06-1999 15:21:19	0.2 CF	10091	8039	2128	6159	11721	4761	2754	2149	1121	3494	2283	1082	477	882	698
Upstream	1 Dif	10-06-1999 15:23:25	0.2 CF	9871	8050	2180	6247	11814	4702	2871	2189	1155	3490	2215	1135	515	920	668
Upstream	1 Dif	10-06-1999 15:25:31	0.2 CF	10016	8108	2137	6163	11960	4761	2966	2212	1129	3420	2245	1173	459	936	702
Upstream	1 Dif	10-06-1999 15:27:37	0.2 CF	9968	8029	2172	6071	11598	4604	2949	2156	1167	3455	2255	1178	441	901	681
Upstream	1 Dif	10-06-1999 15:29:43	0.2 CF	9967	7974	2159	6251	11701	4722	2860	2213	1194	3541	2240	1187	506	918	695
U. Bckgrnd	1 Dif	10-06-1999 15:38:07	0.2 CF	1	0	0	0	1	0	0	0	0	0	0	0	0	0	0
U. Bckgrnd	1 Dif	10-06-1999 15:40:13	0.2 CF	1	0	0	0	0	0	0	0	0	0	0	0	0	0	0

ENTER DATA BELOW

D. Bckgrnd	2 Dif	10-06-1999 15:05:34	0.2 CF	0	0	0	0	0	0	0	0	0	0	0	0	0	0	0
Downstream	2 Dif	10-06-1999 15:11:52	0.2 CF	6478	4634	1175	3039	5102	1566	822	494	219	587	217	66	23	21	4
Downstream	2 Dif	10-06-1999 15:13:58	0.2 CF	6662	4794	1136	3047	5147	1641	850	539	234	594	228	65	21	22	2
Downstream	2 Dif	10-06-1999 15:16:04	0.2 CF	6783	4850	1204	3187	5208	1722	792	516	251	610	222	81	16	22	5
Downstream	2 Dif	10-06-1999 15:18:10	0.2 CF	6606	4728	1166	3194	5230	1649	811	502	235	596	222	79	22	24	7
Downstream	2 Dif	10-06-1999 15:20:16	0.2 CF	6624	4701	1213	3176	5053	1678	821	524	233	582	236	66	16	19	5
Downstream	2 Dif	10-06-1999 15:22:22	0.2 CF	6687	4740	1184	3124	5103	1681	810	460	264	549	235	64	20	22	5
Downstream	2 Dif	10-06-1999 15:24:28	0.2 CF	6537	4825	1174	3102	5064	1679	886	497	227	544	225	79	18	19	4
Downstream	2 Dif	10-06-1999 15:26:34	0.2 CF	6780	4662	1147	3099	5234	1607	754	463	263	525	218	57	17	18	4
Downstream	2 Dif	10-06-1999 15:28:40	0.2 CF	6733	4615	1216	3113	5185	1723	849	514	248	594	205	56	25	23	7
Downstream	2 Dif	10-06-1999 15:30:46	0.2 CF	6715	4786	1153	3196	5204	1656	870	512	252	606	202	81	13	21	6
D. Bckgrnd	2 Dif	10-06-1999 15:39:10	0.2 CF	0	0	0	0	0	0	0	0	0	0	0	0	0	0	0

Meas. Penetration	0.67	0.59	0.55	0.51	0.44	0.35	0.29	0.23	0.21	0.17	0.10	0.06	0.04	0.02	0.01
P100 correction values	1.00	1.00	1.01	1.00	1.00	1.00	1.02	0.99	1.00	1.00	0.99	0.95	0.94	0.89	0.83
Corrected Penetration	0.67	0.59	0.55	0.52	0.44	0.36	0.28	0.24	0.21	0.17	0.10	0.06	0.04	0.03	0.01
Corrected Efficiency (%)	33	41	45	48	56	64	72	76	79	83	90	94	96	97	99

Data Acceptance Criteria:

Total Challenge Counts for Each Channel:	99188	79771	21318	60989	116414	46775	28711	21661	11510	34705	22370	11588	4784	9210	7029
Data Quality Objective:	> 500	> 500	> 500	> 500	> 500	> 500	> 500	> 500	> 500	> 500	> 500	> 500	> 500	> 500	> 500
Does this meet DQO:	Yes	Yes	Yes	Yes	Yes	Yes	Yes	Yes	Yes	Yes	Yes	Yes	Yes	Yes	Yes

Standard Deviation of Penetration for Each Channel :	0.01	0.01	0.02	0.01	0.01	0.01	0.01	0.01	0.01	0.01	0.01	0.01	0.01	0.01	0.00	0.00
Data Quality Objective:	<0.10	<0.10	<0.10	<0.10	<0.10	<0.10	<0.10	<0.10	<0.10	<0.10	<0.30	<0.30	<0.30	<0.30	<0.30	<0.30
Does this meet DQO:	Yes	Yes	Yes	Yes	Yes	Yes	Yes	Yes	Yes	Yes	Yes	Yes	Yes	Yes	Yes	Yes

Maximum observed particle concentration (#/cc):	10.6
Data Quality Objective: max. allowable conc. (#/cc):	< 14
Does this meet the DQO:	Yes, (applies to all channels)

Test No. 10069908
 No Filter
 Solid-Phase

Particle Counts per Indicated OPC Channel (1-Minute Samples @ 7.1 L/min)

OPC Channel Number	1	2	3	4	5	6	7	8	9	10	11	12	13	14	15
Min. Diam. (um)	0.45	0.59	0.73	0.80	1.02	1.44	1.86	2.28	2.85	3.13	4.25	5.66	7.07	7.77	9.88
Max. Diam. (um)	0.59	0.73	0.80	1.02	1.44	1.86	2.28	2.85	3.13	4.25	5.66	7.07	7.77	9.88	14.10
Geo. Mean Diam (um)	0.52	0.66	0.77	0.90	1.21	1.64	2.06	2.55	2.98	3.65	4.91	6.33	7.41	8.76	11.81

ENTER DATA BELOW

U. Bckgrnd	1 Dif	10-06-1999	15:52:49	0.2 CF	2	0	0	0	0	0	0	0	0	0	0	0			
U. Bckgrnd	1 Dif	10-06-1999	15:54:55	0.2 CF	3	0	0	0	0	0	0	0	0	0	0	0			
Upstream	1 Dif	10-06-1999	15:59:11	0.2 CF	10250	8296	2194	6187	12061	4760	2984	2306	1158	3659	2334	1170	467	902	690
Upstream	1 Dif	10-06-1999	16:01:17	0.2 CF	10053	8024	2095	6003	11589	4535	2862	2107	1154	3443	2161	1191	452	841	692
Upstream	1 Dif	10-06-1999	16:03:23	0.2 CF	10285	8112	2164	6115	11492	4596	2860	2128	1169	3545	2229	1138	466	912	659
Upstream	1 Dif	10-06-1999	16:05:29	0.2 CF	10216	7926	2198	6206	11835	4808	2993	2219	1236	3513	2265	1156	473	939	685
Upstream	1 Dif	10-06-1999	16:07:35	0.2 CF	9758	7941	2069	5850	11374	4605	2808	2114	1060	3390	2220	1129	459	820	694
Upstream	1 Dif	10-06-1999	16:09:41	0.2 CF	10018	8218	2125	6105	11764	4792	2877	2135	1107	3464	2305	1185	499	902	680
Upstream	1 Dif	10-06-1999	16:11:47	0.2 CF	10023	8217	2209	6067	11869	4830	2935	2187	1192	3518	2246	1233	451	911	708
Upstream	1 Dif	10-06-1999	16:13:53	0.2 CF	10189	8207	2246	6327	12086	4778	2950	2268	1226	3465	2268	1163	463	878	633
Upstream	1 Dif	10-06-1999	16:15:59	0.2 CF	10127	8206	2195	6423	11810	4798	2992	2161	1187	3560	2275	1131	430	912	704
Upstream	1 Dif	10-06-1999	16:18:05	0.2 CF	9856	7906	2176	5970	11541	4568	2970	2169	1137	3495	2148	1139	465	870	716
U. Bckgrnd	1 Dif	10-06-1999	16:28:35	0.2 CF	0	0	0	0	0	0	0	0	0	0	0	0	0	0	0
U. Bckgrnd	1 Dif	10-06-1999	16:30:41	0.2 CF	1	0	0	0	0	0	0	0	0	0	0	0	0	0	0

ENTER DATA BELOW

D. Bckgrnd	2 Dif	10-06-1999	15:53:52	0.2 CF	2	0	0	0	0	0	0	0	0	0	0	0	0	0	0
Downstream	2 Dif	10-06-1999	16:00:14	0.2 CF	10238	8044	2232	6255	11990	4760	2868	2235	1197	3489	2263	1078	452	866	587
Downstream	2 Dif	10-06-1999	16:02:20	0.2 CF	9923	7980	2137	6035	11711	4609	2803	2113	1100	3457	2211	1137	468	816	571
Downstream	2 Dif	10-06-1999	16:04:26	0.2 CF	9815	7887	2107	6148	11438	4578	2803	2176	1111	3473	2186	1067	467	821	595
Downstream	2 Dif	10-06-1999	16:06:32	0.2 CF	9979	8018	2111	5959	11705	4682	2927	2135	1086	3421	2215	1075	497	783	585
Downstream	2 Dif	10-06-1999	16:08:38	0.2 CF	9937	8047	2230	6058	11607	4675	2946	2086	1153	3507	2170	1094	455	764	562
Downstream	2 Dif	10-06-1999	16:10:44	0.2 CF	10155	8254	2168	6221	11842	4935	3006	2194	1203	3659	2229	1044	437	864	569
Downstream	2 Dif	10-06-1999	16:12:50	0.2 CF	10084	8233	2161	6126	11707	4717	3018	2181	1223	3560	2232	1087	431	800	591
Downstream	2 Dif	10-06-1999	16:14:56	0.2 CF	10111	8127	2273	6316	12011	4832	3049	2248	1210	3508	2213	1086	448	804	592
Downstream	2 Dif	10-06-1999	16:17:02	0.2 CF	10295	8087	2080	6202	11809	4764	2958	2163	1238	3548	2180	1111	461	807	553
Downstream	2 Dif	10-06-1999	16:19:08	0.2 CF	10175	8087	2061	6128	11722	4884	3006	2194	1128	3421	2218	1126	456	828	615
D. Bckgrnd	2 Dif	10-06-1999	16:29:38	0.2 CF	3	1	0	0	0	0	0	0	0	0	0	0	0	0	0

Meas. Penetration	1.00	1.00	0.99	1.00	1.00	1.01	1.01	1.00	1.00	1.00	0.99	0.94	0.99	0.92	0.85
P100 correction values	1.00	1.00	1.00	1.00	1.00	1.00	1.00	1.00	1.00	1.00	1.00	1.00	1.00	1.00	1.00
Corrected Penetration	1.00	1.00	0.99	1.00	1.00	1.01	1.01	1.00	1.00	1.00	0.99	0.94	0.99	0.92	0.85
Corrected Efficiency (%)	0	0	1	0	0	-1	-1	0	0	0	1	6	1	8	15

Data Acceptance Criteria:

Total Challenge Counts for Each Channel:	100775	81053	21671	61253	117421	47070	29231	21794	11626	35052	22451	11635	4625	8887	6861
Data Quality Objective:	> 500	> 500	> 500	> 500	> 500	> 500	> 500	> 500	> 500	> 500	> 500	> 500	> 500	> 500	> 500
Does this meet DQO:	Yes	Yes	Yes	Yes	Yes	Yes	Yes	Yes	Yes	Yes	Yes	Yes	Yes	Yes	Yes

Standard Deviation of Penetration for Each Channel :	0.02	0.02	0.04	0.03	0.02	0.03	0.04	0.04	0.07	0.03	0.03	0.04	0.05	0.05	0.04
Data Quality Objective:	<0.10	<0.10	<0.10	<0.10	<0.10	<0.10	<0.10	<0.10	<0.10	<0.30	<0.30	<0.30	<0.30	<0.30	<0.30
Does this meet DQO:	Yes	Yes	Yes	Yes	Yes	Yes	Yes	Yes	Yes	Yes	Yes	Yes	Yes	Yes	Yes

Maximum observed particle concentration (#/cc):	10.8
Data Quality Objective: max. allowable conc. (#/cc):	< 14
Does this meet the DQO:	Yes, (applies to all channels)

Koch Duo-Pak 650

Test No. 10079901
Arrestor
Solid-Phase

Particle Counts per Indicated OPC Channel (1-Minute Samples @ 7.1 L/min)

OPC Channel Number	1	2	3	4	5	6	7	8	9	10	11	12	13	14	15
Min. Diam. (um)	0.45	0.59	0.73	0.80	1.02	1.44	1.86	2.28	2.85	3.13	4.25	5.66	7.07	7.77	9.88
Max. Diam. (um)	0.59	0.73	0.80	1.02	1.44	1.86	2.28	2.85	3.13	4.25	5.66	7.07	7.77	9.88	14.10
Geo. Mean Diam (um)	0.52	0.66	0.77	0.90	1.21	1.64	2.06	2.55	2.98	3.65	4.91	6.33	7.41	8.76	11.81

ENTER DATA BELOW

U. Bckgrnd	1 Dif	10-07-1999	08:45:56	0.2 CF	0	0	0	0	0	0	0	0	0	0	0	0			
U. Bckgrnd	1 Dif	10-07-1999	08:48:02	0.2 CF	0	0	0	0	0	0	0	0	0	0	0	0			
Upstream	1 Dif	10-07-1999	08:53:17	0.2 CF	10290	8071	2174	6065	11941	5106	3155	2241	1208	3539	2367	1185	482	877	665
Upstream	1 Dif	10-07-1999	08:55:23	0.2 CF	10439	8268	2260	6016	12093	5011	3119	2282	1199	3683	2356	1207	488	906	698
Upstream	1 Dif	10-07-1999	08:57:29	0.2 CF	10219	8031	2134	6098	11838	4947	3068	2304	1156	3740	2373	1188	523	953	703
Upstream	1 Dif	10-07-1999	08:59:35	0.2 CF	10298	8130	2259	6285	12241	4994	3043	2339	1213	3683	2455	1250	500	999	758
Upstream	1 Dif	10-07-1999	09:01:41	0.2 CF	9824	7924	2176	6117	11931	4806	2860	2175	1194	3696	2385	1235	502	913	715
Upstream	1 Dif	10-07-1999	09:03:47	0.2 CF	10014	8279	2246	6001	11851	5046	3027	2236	1173	3653	2322	1214	475	856	662
Upstream	1 Dif	10-07-1999	09:05:53	0.2 CF	10147	8141	2176	6015	11903	4982	2998	2259	1172	3680	2325	1182	512	861	713
Upstream	1 Dif	10-07-1999	09:07:59	0.2 CF	9941	8084	2249	6066	11846	4972	3069	2392	1239	3616	2335	1173	496	902	700
Upstream	1 Dif	10-07-1999	09:10:05	0.2 CF	10327	8076	2246	6107	11910	4823	3108	2374	1137	3699	2302	1215	509	975	675
Upstream	1 Dif	10-07-1999	09:12:11	0.2 CF	9998	8091	2204	5997	11864	4835	3018	2173	1229	3609	2355	1164	476	884	703
U. Bckgrnd	1 Dif	10-07-1999	09:21:40	0.2 CF	0	0	0	0	0	0	0	0	0	0	0	0	0	0	0
U. Bckgrnd	1 Dif	10-07-1999	09:23:46	0.2 CF	7	0	0	0	0	0	0	0	0	0	0	0	0	0	0

ENTER DATA BELOW

D. Bckgrnd	2 Dif	10-07-1999	08:46:59	0.2 CF	4	1	0	0	0	0	0	0	0	0	0	0	0	0	0
Downstream	2 Dif	10-07-1999	08:54:20	0.2 CF	6861	4890	1207	3116	5222	1658	893	498	237	552	227	82	12	20	6
Downstream	2 Dif	10-07-1999	08:56:26	0.2 CF	6892	4621	1188	3057	5187	1764	864	531	256	601	231	62	14	21	5
Downstream	2 Dif	10-07-1999	08:58:32	0.2 CF	6867	4733	1212	3078	5269	1735	871	550	262	646	257	81	21	15	10
Downstream	2 Dif	10-07-1999	09:00:38	0.2 CF	6727	4787	1241	3133	5143	1747	855	531	255	615	225	69	17	25	8
Downstream	2 Dif	10-07-1999	09:02:44	0.2 CF	6762	4876	1250	3228	5239	1730	856	535	239	631	245	73	22	24	5
Downstream	2 Dif	10-07-1999	09:04:50	0.2 CF	6565	4515	1138	3160	5194	1661	826	480	247	577	208	61	13	23	6
Downstream	2 Dif	10-07-1999	09:06:56	0.2 CF	6831	4825	1238	3079	5120	1696	890	499	242	558	224	73	12	16	2
Downstream	2 Dif	10-07-1999	09:09:02	0.2 CF	6483	4663	1192	2988	5002	1663	799	531	236	585	226	59	10	19	8
Downstream	2 Dif	10-07-1999	09:11:08	0.2 CF	6619	4651	1152	3082	5032	1712	847	485	219	569	229	68	20	16	5
Downstream	2 Dif	10-07-1999	09:13:14	0.2 CF	6778	4758	1207	3133	5097	1639	851	477	252	617	224	67	18	17	6
D. Bckgrnd	2 Dif	10-07-1999	09:22:43	0.2 CF	2	0	0	0	0	0	0	0	0	0	0	0	0	0	0

Meas. Penetration	0.66	0.58	0.54	0.51	0.43	0.34	0.28	0.22	0.21	0.16	0.10	0.06	0.03	0.02	0.01
P100 correction values	1.00	1.00	0.99	1.00	1.00	1.01	1.01	1.00	1.00	1.00	0.99	0.94	0.99	0.92	0.85
Corrected Penetration	0.66	0.59	0.55	0.51	0.43	0.34	0.28	0.23	0.20	0.16	0.10	0.06	0.03	0.02	0.01
Corrected Efficiency (%)	34	41	45	49	57	66	72	77	80	84	90	94	97	98	99

Data Acceptance Criteria:

Total Challenge Counts for Each Channel:	101497	81095	22124	60767	119418	49522	30465	22775	11920	36598	23575	12013	4963	9126	6992
Data Quality Objective:	> 500	> 500	> 500	> 500	> 500	> 500	> 500	> 500	> 500	> 500	> 500	> 500	> 500	> 500	> 500
Does this meet DQO:	Yes	Yes	Yes	Yes	Yes	Yes	Yes	Yes	Yes	Yes	Yes	Yes	Yes	Yes	Yes

Standard Deviation of Penetration for Each Channel :	0.02	0.02	0.02	0.01	0.01	0.01	0.01	0.01	0.01	0.01	0.01	0.01	0.01	0.00	0.00
Data Quality Objective:	<0.10	<0.10	<0.10	<0.10	<0.10	<0.10	<0.10	<0.10	<0.10	<0.30	<0.30	<0.30	<0.30	<0.30	<0.30
Does this meet DQO:	Yes	Yes	Yes	Yes	Yes	Yes	Yes	Yes	Yes	Yes	Yes	Yes	Yes	Yes	Yes

Maximum observed particle concentration (#/cc):	11.0
Data Quality Objective: max. allowable conc. (#/cc):	< 14
Does this meet the DQO:	Yes, (applies to all channels)

Test No. 10079902

No Filter

Solid-Phase

Particle Counts per Indicated OPC Channel (1-Minute Samples @ 7.1 L/min)

OPC Channel Number	1	2	3	4	5	6	7	8	9	10	11	12	13	14	15
Min. Diam. (um)	0.45	0.59	0.73	0.80	1.02	1.44	1.86	2.28	2.85	3.13	4.25	5.66	7.07	7.77	9.88
Max. Diam. (um)	0.59	0.73	0.80	1.02	1.44	1.86	2.28	2.85	3.13	4.25	5.66	7.07	7.77	9.88	14.10
Geo. Mean Diam (um)	0.52	0.66	0.77	0.90	1.21	1.64	2.06	2.55	2.98	3.65	4.91	6.33	7.41	8.76	11.81

ENTER DATA BELOW

U. Bckgrnd	1 Dif	10-07-1999	09:36:22	0.2 CF	1	0	0	0	0	0	0	0	0	0	0	0	0	0	
U. Bckgrnd	1 Dif	10-07-1999	09:38:28	0.2 CF	0	0	0	0	0	0	0	0	0	0	0	0	0	0	
Upstream	1 Dif	10-07-1999	09:42:40	0.2 CF	10315	8351	2254	6238	12010	4897	3014	2329	1216	3673	2351	1203	504	937	726
Upstream	1 Dif	10-07-1999	09:44:46	0.2 CF	10100	7947	2133	6102	11781	4675	3085	2256	1218	3610	2278	1254	483	945	741
Upstream	1 Dif	10-07-1999	09:46:52	0.2 CF	10293	8290	2253	6168	12031	4821	3013	2183	1194	3557	2388	1183	496	915	715
Upstream	1 Dif	10-07-1999	09:48:58	0.2 CF	10133	8148	2244	6175	12032	4831	2882	2275	1234	3549	2314	1191	499	931	711
Upstream	1 Dif	10-07-1999	09:51:04	0.2 CF	10237	8041	2255	6197	11973	4894	2967	2200	1137	3661	2327	1154	477	920	711
Upstream	1 Dif	10-07-1999	09:53:10	0.2 CF	10453	8354	2257	6404	12261	4928	3051	2275	1208	3584	2356	1222	500	959	750
Upstream	1 Dif	10-07-1999	09:55:16	0.2 CF	10424	8367	2238	6404	12169	4907	3020	2327	1303	3676	2340	1159	467	965	678
Upstream	1 Dif	10-07-1999	09:57:22	0.2 CF	10132	8189	2220	6202	12046	4916	2911	2211	1203	3617	2352	1170	498	933	728
Upstream	1 Dif	10-07-1999	09:59:28	0.2 CF	10629	8300	2282	6380	12298	4957	3047	2269	1163	3607	2422	1192	439	919	692
Upstream	1 Dif	10-07-1999	10:01:34	0.2 CF	10131	8008	2120	6094	11845	4815	2948	2280	1224	3472	2325	1208	472	967	675
U. Bckgrnd	1 Dif	10-07-1999	10:18:41	0.2 CF	2	0	0	0	0	0	0	0	0	0	0	0	0	0	0
U. Bckgrnd	1 Dif	10-07-1999	10:20:47	0.2 CF	6	0	0	0	0	0	0	0	0	0	0	0	0	0	0

ENTER DATA BELOW

D. Bckgrnd	Dif	10-07-1999	09:37:25	0.2 CF	0	0	0	0	0	0	0	0	0	0	0	0	0	0	0
Downstream	2 Dif	10-07-1999	09:43:43	0.2 CF	10352	8403	2195	6279	12069	5095	2988	2223	1213	3568	2238	1122	429	756	489
Downstream	2 Dif	10-07-1999	09:45:49	0.2 CF	10214	8212	2223	6155	12054	4919	3049	2205	1192	3634	2269	1154	466	790	561
Downstream	2 Dif	10-07-1999	09:47:55	0.2 CF	10343	8353	2309	6180	12107	4962	3025	2288	1134	3591	2253	1191	457	810	557
Downstream	2 Dif	10-07-1999	09:50:01	0.2 CF	10187	8216	2307	6177	11923	4901	2992	2224	1232	3713	2349	1155	417	808	560
Downstream	2 Dif	10-07-1999	09:52:07	0.2 CF	10293	8363	2198	6259	12025	4961	2960	2193	1190	3655	2325	1105	448	776	511
Downstream	2 Dif	10-07-1999	09:54:13	0.2 CF	10563	8343	2148	6285	12408	5029	3154	2379	1181	3689	2258	1167	408	774	518
Downstream	2 Dif	10-07-1999	09:56:19	0.2 CF	10377	8289	2246	6241	12067	5007	3032	2215	1180	3699	2213	1093	436	729	515
Downstream	2 Dif	10-07-1999	09:58:25	0.2 CF	10493	8323	2277	6383	12459	5157	3103	2294	1206	3635	2356	1168	423	756	558
Downstream	2 Dif	10-07-1999	10:00:31	0.2 CF	10316	8349	2274	6266	12186	5021	2987	2322	1175	3727	2376	1169	400	784	580
Downstream	2 Dif	10-07-1999	10:02:37	0.2 CF	10167	8295	2260	6310	11958	4870	3041	2274	1168	3595	2290	1138	441	810	556
D. Bckgrnd	2 Dif	10-07-1999	10:19:44	0.2 CF	4	0	0	0	0	0	0	0	0	0	0	0	0	0	0

Meas. Penetration	1.00	1.01	1.01	1.00	1.01	1.03	1.01	1.00	1.00	0.98	1.01	0.98	0.96	0.89	0.83	0.76
P100 correction values	1.00	1.00	1.00	1.00	1.00	1.00	1.00	1.00	1.00	1.00	1.00	1.00	1.00	1.00	1.00	1.00
Corrected Penetration	1.00	1.01	1.01	1.00	1.01	1.03	1.01	1.00	0.98	1.01	0.98	0.96	0.89	0.83	0.76	
Corrected Efficiency (%)	0	-1	-1	0	-1	-3	-1	0	2	-1	2	4	11	17	24	

Data Acceptance Criteria:

Total Challenge Counts for Each Channel:	102847	81995	22256	62364	120446	48641	29938	22605	12100	36006	23453	11936	4835	9391	7127
Data Quality Objective:	> 500	> 500	> 500	> 500	> 500	> 500	> 500	> 500	> 500	> 500	> 500	> 500	> 500	> 500	> 500
Does this meet DQO:	Yes	Yes	Yes	Yes	Yes	Yes	Yes	Yes	Yes	Yes	Yes	Yes	Yes	Yes	Yes

Standard Deviation of Penetration for Each Channel :	0.02	0.02	0.03	0.02	0.02	0.03	0.03	0.03	0.04	0.02	0.03	0.04	0.06	0.03	0.05
Data Quality Objective:	<0.10	<0.10	<0.10	<0.10	<0.10	<0.10	<0.10	<0.10	<0.10	<0.30	<0.30	<0.30	<0.30	<0.30	<0.30
Does this meet DQO:	Yes	Yes	Yes	Yes	Yes	Yes	Yes	Yes	Yes	Yes	Yes	Yes	Yes	Yes	Yes

Maximum observed particle concentration (#/cc):	11.0
Data Quality Objective: max. allowable conc. (#/cc):	< 14
Does this meet the DQO:	Yes, (applies to all channels)

Test No. 10079903

Arrestor

Solid-Phase

Particle Counts per Indicated OPC Channel (1-Minute Samples @ 7.1 L/min)

OPC Channel Number	1	2	3	4	5	6	7	8	9	10	11	12	13	14	15
Min. Diam. (um)	0.45	0.59	0.73	0.80	1.02	1.44	1.86	2.28	2.85	3.13	4.25	5.66	7.07	7.77	9.88
Max. Diam. (um)	0.59	0.73	0.80	1.02	1.44	1.86	2.28	2.85	3.13	4.25	5.66	7.07	7.77	9.88	14.10
Geo. Mean Diam (um)	0.52	0.66	0.77	0.90	1.21	1.64	2.06	2.55	2.98	3.65	4.91	6.33	7.41	8.76	11.81

ENTER DATA BELOW

U. Bckgrnd	1 Dif	10-07-1999	10:37:35	0.2 CF	0	0	0	0	0	0	0	0	0	0	0	0
U. Bckgrnd	1 Dif	10-07-1999	10:39:41	0.2 CF	3	0	0	0	0	0	0	0	0	0	0	0
Upstream	1 Dif	10-07-1999	10:43:53	0.2 CF	10120	8100	2239	6170	11905	4828	2919	2260	1195	3438	2381	1185
Upstream	1 Dif	10-07-1999	10:45:59	0.2 CF	10182	8080	2287	6089	11972	4722	2982	2247	1152	3658	2323	1213
Upstream	1 Dif	10-07-1999	10:48:05	0.2 CF	10135	8220	2177	6249	11617	4799	2953	2144	1175	3479	2327	1171
Upstream	1 Dif	10-07-1999	10:50:11	0.2 CF	10391	8208	2271	6122	11891	4898	2997	2170	1169	3632	2344	1185
Upstream	1 Dif	10-07-1999	10:52:17	0.2 CF	9991	7977	2148	6022	11895	4809	2872	2120	1161	3574	2256	1163
Upstream	1 Dif	10-07-1999	10:54:23	0.2 CF	9945	8063	2209	6124	11719	4760	2910	2194	1216	3638	2289	1170
Upstream	1 Dif	10-07-1999	10:56:29	0.2 CF	10098	8103	2202	6038	11951	4786	2944	2157	1144	3509	2339	1211
Upstream	1 Dif	10-07-1999	10:58:35	0.2 CF	10269	8173	2252	6358	12133	4849	3016	2277	1174	3568	2320	1130
Upstream	1 Dif	10-07-1999	11:00:41	0.2 CF	10318	8127	2164	6073	11870	4859	2999	2215	1144	3617	2234	1149
Upstream	1 Dif	10-07-1999	11:02:47	0.2 CF	10082	7983	2249	6081	11842	4985	2969	2170	1100	3529	2284	1151
U. Bckgrnd	1 Dif	10-07-1999	11:13:17	0.2 CF	0	0	0	0	0	0	0	0	0	0	0	0
U. Bckgrnd	1 Dif	10-07-1999	11:15:23	0.2 CF	0	0	0	0	0	0	0	0	0	0	0	0

ENTER DATA BELOW

D. Bckgrnd	2 Dif	10-07-1999	10:38:38	0.2 CF	1	0	0	0	0	0	0	0	0	0	0	0
Downstream	2 Dif	10-07-1999	10:44:56	0.2 CF	7075	4806	1259	3233	5269	1716	858	496	264	576	241	68
Downstream	2 Dif	10-07-1999	10:47:02	0.2 CF	6858	4899	1285	3334	5300	1703	861	554	276	575	259	82
Downstream	2 Dif	10-07-1999	10:49:08	0.2 CF	6797	4720	1210	3161	5298	1688	835	521	267	566	223	79
Downstream	2 Dif	10-07-1999	10:51:14	0.2 CF	6932	4899	1206	3133	5443	1716	870	528	264	594	251	65
Downstream	2 Dif	10-07-1999	10:53:20	0.2 CF	6618	4678	1243	3178	5279	1665	861	511	238	565	247	58
Downstream	2 Dif	10-07-1999	10:55:26	0.2 CF	6844	4779	1201	3107	5178	1710	897	470	221	606	230	68
Downstream	2 Dif	10-07-1999	10:57:32	0.2 CF	6831	4887	1207	3227	5309	1725	800	481	255	610	219	66
Downstream	2 Dif	10-07-1999	10:59:38	0.2 CF	6825	4786	1185	3139	5125	1689	846	475	241	574	249	70
Downstream	2 Dif	10-07-1999	11:01:44	0.2 CF	6898	4836	1183	3127	5278	1705	902	532	252	605	225	48
Downstream	2 Dif	10-07-1999	11:03:50	0.2 CF	6777	4662	1228	3018	5516	1810	840	521	253	603	243	63
D. Bckgrnd	2 Dif	10-07-1999	11:14:20	0.2 CF	1	0	0	0	0	0	0	0	0	0	0	0

Meas. Penetration	0.67	0.59	0.55	0.52	0.45	0.35	0.29	0.23	0.22	0.16	0.10	0.06	0.04	0.02	0.01
P100 correction values	1.00	1.01	1.01	1.00	1.01	1.03	1.01	1.00	0.98	1.01	0.98	0.96	0.89	0.83	0.76
Corrected Penetration	0.67	0.58	0.55	0.51	0.44	0.35	0.29	0.23	0.22	0.16	0.11	0.06	0.04	0.03	0.01
Corrected Efficiency (%)	33	42	45	49	56	65	71	77	78	84	89	94	96	97	99

Data Acceptance Criteria:

Total Challenge Counts for Each Channel:	101531	81034	22198	61326	118795	48295	29561	21954	11630	35642	23097	11728	4828	9201	6811
Data Quality Objective:	> 500	> 500	> 500	> 500	> 500	> 500	> 500	> 500	> 500	> 500	> 500	> 500	> 500	> 500	> 500
Does this meet DQO:	Yes	Yes	Yes	Yes	Yes	Yes	Yes	Yes	Yes	Yes	Yes	Yes	Yes	Yes	Yes

Standard Deviation of Penetration for Each Channel :	0.01	0.01	0.02	0.02	0.01	0.01	0.01	0.01	0.02	0.01	0.01	0.01	0.01	0.01	0.00
Data Quality Objective:	<0.10	<0.10	<0.10	<0.10	<0.10	<0.10	<0.10	<0.10	<0.10	<0.30	<0.30	<0.30	<0.30	<0.30	<0.30
Does this meet DQO:	Yes	Yes	Yes	Yes	Yes	Yes	Yes	Yes	Yes	Yes	Yes	Yes	Yes	Yes	Yes

Maximum observed particle concentration (#/cc):	10.8
Data Quality Objective: max. allowable conc. (#/cc):	< 14
Does this meet the DQO:	Yes, (applies to all channels)

Test No. 10059902

HEPA
Solid-Phase

Particle Counts per Indicated OPC Channel (1-Minute Samples @ 7.1 L/min)

OPC Channel Number	1	2	3	4	5	6	7	8	9	10	11	12	13	14	15
Min. Diam. (um)	0.45	0.59	0.73	0.80	1.02	1.44	1.86	2.28	2.85	3.13	4.25	5.66	7.07	7.77	9.88
Max. Diam. (um)	0.59	0.73	0.80	1.02	1.44	1.86	2.28	2.85	3.13	4.25	5.66	7.07	7.77	9.88	14.10
Geo. Mean Diam (um)	0.52	0.66	0.77	0.90	1.21	1.64	2.06	2.55	2.98	3.65	4.91	6.33	7.41	8.76	11.81

ENTER DATA BELOW

U. Bckgrnd	1 Dif	10-05-1999	11:37:49	0.2 CF	4	0	0	0	0	0	0	0	0	0	0	0			
U. Bckgrnd	1 Dif	10-05-1999	11:39:55	0.2 CF	4	0	0	0	0	0	0	0	0	0	0	0			
Upstream	1 Dif	10-05-1999	11:44:07	0.2 CF	9653	7944	2123	5980	11262	4597	2770	2053	1111	3400	2179	1114	410	827	585
Upstream	1 Dif	10-05-1999	11:46:13	0.2 CF	9648	7858	2087	5990	11344	4527	2758	2071	1186	3464	2116	1045	484	824	619
Upstream	1 Dif	10-05-1999	11:48:19	0.2 CF	10140	8246	2078	6124	11836	4773	2855	2059	1182	3478	2209	1193	511	901	662
Upstream	1 Dif	10-05-1999	11:50:25	0.2 CF	10118	8385	2240	6274	11853	4741	2863	2119	1148	3477	2222	1169	510	864	668
Upstream	1 Dif	10-05-1999	11:52:31	0.2 CF	10058	8216	2254	6160	11874	4684	2975	2120	1119	3572	2213	1225	430	856	601
Upstream	1 Dif	10-05-1999	11:54:37	0.2 CF	10401	8389	2206	6369	12131	4793	3036	2221	1230	3586	2135	1268	421	895	602
Upstream	1 Dif	10-05-1999	11:56:43	0.2 CF	9930	8305	2099	6098	11600	4652	2764	2035	1101	3377	2173	1160	447	857	664
Upstream	1 Dif	10-05-1999	11:58:49	0.2 CF	9844	8047	2045	6206	11681	4488	2773	2224	1078	3518	2248	1138	477	850	660
Upstream	1 Dif	10-05-1999	12:00:55	0.2 CF	9979	8065	2165	6176	11467	4519	2825	2067	1099	3396	2208	1171	471	814	660
Upstream	1 Dif	10-05-1999	12:03:01	0.2 CF	9771	8049	2095	6146	11736	4626	2798	2047	1089	3466	2080	1168	428	835	620
U. Bckgrnd	1 Dif	10-05-1999	12:11:25	0.2 CF	1	1	0	0	0	0	0	0	0	0	0	0	0	0	0
U. Bckgrnd	1 Dif	10-05-1999	12:13:31	0.2 CF	0	0	0	0	0	0	0	0	0	0	0	0	0	0	0

ENTER DATA BELOW

D. Bckgrnd	2 Dif	10-05-1999	11:38:52	0.2 CF	3	0	0	0	0	0	0	0	0	0	0	0	0	0	0
Downstream	2 Dif	10-05-1999	11:45:10	0.2 CF	16	9	3	13	6	3	1	5	1	4	2	3	0	0	0
Downstream	2 Dif	10-05-1999	11:47:16	0.2 CF	14	10	0	10	14	3	1	1	2	3	0	1	0	0	0
Downstream	2 Dif	10-05-1999	11:49:22	0.2 CF	13	12	4	8	14	8	2	0	1	3	2	0	0	1	1
Downstream	2 Dif	10-05-1999	11:51:28	0.2 CF	12	11	1	10	15	3	5	3	2	3	2	4	1	0	2
Downstream	2 Dif	10-05-1999	11:53:34	0.2 CF	20	13	3	6	13	5	3	4	1	1	2	1	0	0	0
Downstream	2 Dif	10-05-1999	11:55:40	0.2 CF	11	8	5	13	17	5	2	4	0	2	1	2	0	0	0
Downstream	2 Dif	10-05-1999	11:57:46	0.2 CF	18	9	3	4	18	5	2	3	0	4	2	1	0	0	0
Downstream	2 Dif	10-05-1999	11:59:52	0.2 CF	13	10	6	5	12	4	5	0	3	3	3	0	0	0	0
Downstream	2 Dif	10-05-1999	12:01:58	0.2 CF	15	10	0	10	5	4	2	1	0	3	0	0	1	1	0
Downstream	2 Dif	10-05-1999	12:04:04	0.2 CF	21	10	2	13	13	4	5	1	0	1	0	0	0	1	0
D. Bckgrnd	2 Dif	10-05-1999	12:12:28	0.2 CF	0	0	0	0	0	0	0	0	0	0	0	0	0	0	0

Meas. Penetration	0.00	0.00	0.00	0.00	0.00	0.00	0.00	0.00	0.00	0.00	0.00	0.00	0.00	0.00	0.00	0.00	0.00	0.00
P100 correction values	1.00	1.00	1.00	1.00	1.01	1.00	1.02	1.00	1.00	1.01	1.01	0.99	0.98	0.98	0.97			
Corrected Penetration	0.00	0.00	0.00	0.00	0.00	0.00	0.00	0.00	0.00	0.00	0.00	0.00	0.00	0.00	0.00	0.00	0.00	0.00
Corrected Efficiency (%)	100	100	100	100	100	100	100	100	100	100	100	100	100	100	100	100	100	100

Data Acceptance Criteria:

Total Challenge Counts for Each Channel:	99542	81504	21392	61523	116784	46400	28417	21016	11343	34734	21783	11651	4589	8523	6341
Data Quality Objective:	> 500	> 500	> 500	> 500	> 500	> 500	> 500	> 500	> 500	> 500	> 500	> 500	> 500	> 500	> 500
Does this meet DQO:	Yes	Yes	Yes	Yes	Yes	Yes	Yes	Yes	Yes	Yes	Yes	Yes	Yes	Yes	Yes

Standard Deviation of Penetration for Each Channel :	0.00	0.00	0.00	0.00	0.00	0.00	0.00	0.00	0.00	0.00	0.00	0.00	0.00	0.00	0.00
Data Quality Objective:	<0.10	<0.10	<0.10	<0.10	<0.10	<0.10	<0.10	<0.10	<0.10	<0.30	<0.30	<0.30	<0.30	<0.30	<0.30
Does this meet DQO:	Yes	Yes	Yes	Yes	Yes	Yes	Yes	Yes	Yes	Yes	Yes	Yes	Yes	Yes	Yes

Maximum observed particle concentration (#/cc):	10.8
Data Quality Objective: max. allowable conc. (#/cc):	< 14
Does this meet the DQO:	Yes, (applies to all channels)

Test No. 10079904
 No Filter
 Liquid-Phase

Particle Counts per Indicated OPC Channel (1-Minute Samples @ 7.1 L/min)

OPC Channel Number	1	2	3	4	5	6	7	8	9	10	11	12	13	14	15
Min. Diam. (um)	0.28	0.37	0.47	0.52	0.66	0.94	1.22	1.51	1.88	2.07	2.83	3.77	4.71	5.18	6.60
Max. Diam. (um)	0.37	0.47	0.52	0.66	0.94	1.22	1.51	1.88	2.07	2.83	3.77	4.71	5.18	6.60	9.43
Geo. Mean Diam (um)	0.32	0.42	0.49	0.58	0.78	1.07	1.36	1.68	1.97	2.42	3.26	4.21	4.94	5.85	7.89

ENTER DATA BELOW

U. Bckgrnd	1 Dif	10-07-1999	12:50:43	0.2 CF	0	0	0	0	0	0	0	0	0	0	0	0
U. Bckgrnd	1 Dif	10-07-1999	12:52:49	0.2 CF	1	0	0	0	0	0	0	0	0	0	0	0
Upstream	1 Dif	10-07-1999	13:04:24	0.2 CF	10297	7673	2072	5494	12383	7171	4844	4210	2519	7434	2849	1300
Upstream	1 Dif	10-07-1999	13:06:30	0.2 CF	10003	7449	2108	5242	12239	7000	4742	4246	2539	7084	2819	1261
Upstream	1 Dif	10-07-1999	13:08:36	0.2 CF	9831	7556	1987	5380	12170	7120	4705	4216	2457	7164	2858	1268
Upstream	1 Dif	10-07-1999	13:10:42	0.2 CF	9397	7041	1981	5037	11497	6704	4447	3901	2308	6560	2684	1246
Upstream	1 Dif	10-07-1999	13:12:48	0.2 CF	9387	6894	1918	4836	11417	6458	4306	3804	2364	6663	2527	1212
Upstream	1 Dif	10-07-1999	13:14:54	0.2 CF	9121	6850	1853	4910	11368	6609	4283	3636	2258	6620	2528	1212
Upstream	1 Dif	10-07-1999	13:17:00	0.2 CF	9141	6919	1900	4940	11240	6428	4263	3861	2373	6653	2590	1217
Upstream	1 Dif	10-07-1999	13:19:06	0.2 CF	9075	6904	1854	4899	11143	6451	4222	3798	2325	6562	2567	1112
Upstream	1 Dif	10-07-1999	13:21:12	0.2 CF	9036	6865	1795	4737	11292	6415	4389	3714	2269	6483	2485	1143
Upstream	1 Dif	10-07-1999	13:23:18	0.2 CF	9043	6808	1942	4785	10988	6488	4195	3688	2256	6375	2412	1192
U. Bckgrnd	1 Dif	10-07-1999	13:34:28	0.2 CF	1	0	0	0	0	0	0	0	0	0	0	0
U. Bckgrnd	1 Dif	10-07-1999	13:36:34	0.2 CF	1	0	0	0	0	0	0	0	0	0	0	0

ENTER DATA BELOW

D. Bckgrnd	2 Dif	10-07-1999	12:51:46	0.2 CF	0	0	0	0	0	0	0	0	0	0	0	0
Downstream	2 Dif	10-07-1999	13:05:27	0.2 CF	10252	7579	2121	5350	12449	7298	4798	4114	2537	7299	2841	1237
Downstream	2 Dif	10-07-1999	13:07:33	0.2 CF	9877	7343	2095	5302	12097	7136	4683	4017	2386	6976	2788	1187
Downstream	2 Dif	10-07-1999	13:09:39	0.2 CF	9810	7273	2023	5164	12040	6951	4544	3976	2376	6915	2708	1181
Downstream	2 Dif	10-07-1999	13:11:45	0.2 CF	9596	7070	1976	4992	11650	6660	4308	3945	2380	6867	2530	1207
Downstream	2 Dif	10-07-1999	13:13:51	0.2 CF	9220	6831	1996	4892	11390	6623	4291	3802	2276	6598	2551	1130
Downstream	2 Dif	10-07-1999	13:15:57	0.2 CF	9033	6750	1909	4781	11289	6510	4194	3689	2299	6614	2474	1133
Downstream	2 Dif	10-07-1999	13:18:03	0.2 CF	9107	6742	1883	4800	11065	6500	4165	3619	2316	6585	2557	1061
Downstream	2 Dif	10-07-1999	13:20:09	0.2 CF	9374	7123	1930	4890	11522	6648	4286	3820	2339	6714	2477	1161
Downstream	2 Dif	10-07-1999	13:22:15	0.2 CF	8885	6642	1788	4702	11158	6497	4241	3730	2293	6612	2530	1146
Downstream	2 Dif	10-07-1999	13:24:21	0.2 CF	9257	6584	1845	4855	11312	6401	4369	3759	2343	6590	2571	1077
D. Bckgrnd	2 Dif	10-07-1999	13:35:31	0.2 CF	2	1	0	0	0	0	0	0	0	0	0	0

Meas. Penetration	1.00	0.99	1.01	0.99	1.00	1.01	0.99	0.98	0.99	1.00	0.99	0.95	0.89	0.83	0.66
P100 correction values	1.00	1.00	1.00	1.00	1.00	1.00	1.00	1.00	1.00	1.00	1.00	1.00	1.00	1.00	1.00
Corrected Penetration	1.00	0.99	1.01	0.99	1.00	1.01	0.99	0.98	0.99	1.00	0.99	0.95	0.89	0.83	0.66
Corrected Efficiency (%)	0	1	-1	1	0	-1	1	2	1	0	1	5	11	17	34

Data Acceptance Criteria:

Total Challenge Counts for Each Channel:	94331	70959	19410	50260	115737	66844	44396	39074	23668	67598	26319	12163	5256	8876	3628
Data Quality Objective:	> 500	> 500	> 500	> 500	> 500	> 500	> 500	> 500	> 500	> 500	> 500	> 500	> 500	> 500	> 500
Does this meet DQO:	Yes	Yes	Yes	Yes	Yes	Yes	Yes	Yes	Yes	Yes	Yes	Yes	Yes	Yes	Yes

Standard Deviation of Penetration for Each Channel :	0.07	0.07	0.08	0.07	0.06	0.06	0.07	0.07	0.05	0.06	0.08	0.06	0.05	0.06	0.07
Data Quality Objective:	<0.10	<0.10	<0.10	<0.10	<0.10	<0.10	<0.10	<0.10	<0.10	<0.10	<0.30	<0.30	<0.30	<0.30	<0.30
Does this meet DQO:	Yes	Yes	Yes	Yes	Yes	Yes	Yes	Yes	Yes	Yes	Yes	Yes	Yes	Yes	Yes

Maximum observed particle concentration (#/cc):	12.7
Data Quality Objective: max. allowable conc. (#/cc):	< 14
Does this meet the DQO:	Yes, (applies to all channels)

Koch Duo-Pak 650

Test No. 10079905
Arrestor
Liquid-Phase

Particle Counts per Indicated OPC Channel (1-Minute Samples @ 7.1 L/min)

OPC Channel Number	1	2	3	4	5	6	7	8	9	10	11	12	13	14	15
Min. Diam. (um)	0.28	0.37	0.47	0.52	0.66	0.94	1.22	1.51	1.88	2.07	2.83	3.77	4.71	5.18	6.60
Max. Diam. (um)	0.37	0.47	0.52	0.66	0.94	1.22	1.51	1.88	2.07	2.83	3.77	4.71	5.18	6.60	9.43
Geo. Mean Diam (um)	0.32	0.42	0.49	0.58	0.78	1.07	1.36	1.68	1.97	2.42	3.26	4.21	4.94	5.85	7.89

ENTER DATA BELOW

U. Bckgrnd	1 Dif	10-07-1999	14:42:06	0.2 CF	0	0	0	0	0	0	0	0	0	0	0	0			
U. Bckgrnd	1 Dif	10-07-1999	14:44:12	0.2 CF	0	0	0	0	0	0	0	0	0	0	0	0			
Upstream	1 Dif	10-07-1999	14:50:30	0.2 CF	10068	7680	2086	5331	13024	7052	4679	4215	2749	7065	2758	1308	569	928	367
Upstream	1 Dif	10-07-1999	14:52:36	0.2 CF	9877	7481	2082	5261	12391	6800	4639	4070	2626	7039	2707	1257	533	885	379
Upstream	1 Dif	10-07-1999	14:54:42	0.2 CF	9995	7794	2046	5361	12853	6932	4907	4232	2808	7204	2725	1262	532	947	362
Upstream	1 Dif	10-07-1999	14:56:48	0.2 CF	10066	7931	2118	5506	13484	7116	5043	4372	2759	7365	2741	1287	547	965	389
Upstream	1 Dif	10-07-1999	14:58:54	0.2 CF	10154	7799	2183	5450	13089	7086	4828	4203	2753	7237	2729	1328	532	942	378
Upstream	1 Dif	10-07-1999	15:01:00	0.2 CF	10156	7751	2230	5405	12752	6967	4817	4285	2644	7167	2730	1355	547	966	356
Upstream	1 Dif	10-07-1999	15:03:06	0.2 CF	9935	7482	2143	5364	12665	6885	4794	4070	2698	7013	2597	1304	514	884	355
Upstream	1 Dif	10-07-1999	15:05:12	0.2 CF	9786	7436	2025	5119	12610	6815	4680	4035	2680	6933	2650	1244	585	883	395
Upstream	1 Dif	10-07-1999	15:07:18	0.2 CF	9962	7430	2078	5144	12582	6838	4623	4281	2701	7057	2734	1272	542	870	365
Upstream	1 Dif	10-07-1999	15:11:30	0.2 CF	10101	7645	2090	5283	12831	6862	4800	4217	2676	7133	2750	1356	554	913	375
U. Bckgrnd	1 Dif	10-07-1999	15:22:00	0.2 CF	3	0	0	0	0	0	0	0	0	0	0	0	0	0	0
U. Bckgrnd	1 Dif	10-07-1999	15:24:06	0.2 CF	0	0	0	0	0	0	0	0	0	0	0	0	0	0	0

ENTER DATA BELOW

D. Bckgrnd	2 Dif	10-07-1999	14:43:09	0.2 CF	1	0	0	0	0	0	0	0	0	0	0	0	0	0	0
Downstream	2 Dif	10-07-1999	14:51:33	0.2 CF	7645	5404	1457	3676	8084	3973	2537	1720	1063	2479	618	165	56	47	4
Downstream	2 Dif	10-07-1999	14:53:39	0.2 CF	7665	5385	1545	3672	8090	4023	2445	1714	1054	2355	581	138	44	36	7
Downstream	2 Dif	10-07-1999	14:55:45	0.2 CF	7789	5637	1454	3637	8358	4040	2470	1726	1039	2438	655	177	46	37	7
Downstream	2 Dif	10-07-1999	14:57:51	0.2 CF	7630	5445	1521	3700	8236	4037	2446	1731	1088	2473	575	168	36	43	7
Downstream	2 Dif	10-07-1999	14:59:57	0.2 CF	7875	5573	1478	3730	8295	4105	2453	1781	1121	2430	616	142	34	49	8
Downstream	2 Dif	10-07-1999	15:02:03	0.2 CF	7705	5372	1448	3603	8204	3925	2355	1751	1007	2364	609	175	55	36	15
Downstream	2 Dif	10-07-1999	15:04:09	0.2 CF	7617	5215	1468	3654	8224	4094	2368	1708	1038	2330	567	172	53	37	5
Downstream	2 Dif	10-07-1999	15:06:15	0.2 CF	7365	5146	1408	3571	7808	3947	2344	1674	978	2390	563	169	50	61	10
Downstream	2 Dif	10-07-1999	15:08:21	0.2 CF	7305	5033	1436	3329	7972	3912	2329	1626	1006	2288	574	152	41	41	5
Downstream	2 Dif	10-07-1999	15:10:27	0.2 CF	7335	5169	1351	3423	8019	3993	2386	1592	1041	2303	577	137	38	36	10
D. Bckgrnd	2 Dif	10-07-1999	15:23:03	0.2 CF	2	0	0	0	0	0	0	0	0	0	0	0	0	0	0

Meas. Penetration	0.76	0.70	0.69	0.68	0.63	0.58	0.50	0.41	0.39	0.33	0.22	0.12	0.08	0.05	0.02
P100 correction values	1.00	0.99	1.01	0.99	1.00	1.01	0.99	0.98	0.99	1.00	0.99	0.95	0.89	0.83	0.66
Corrected Penetration	0.76	0.71	0.69	0.68	0.63	0.57	0.51	0.41	0.39	0.33	0.22	0.13	0.09	0.06	0.03
Corrected Efficiency (%)	24	29	31	32	37	43	49	59	61	67	78	87	91	94	97

Data Acceptance Criteria:

Total Challenge Counts for Each Channel:	100100	76429	21081	53224	128281	69353	47810	41980	27094	71213	27121	12973	5455	9183	3721
Data Quality Objective:	> 500	> 500	> 500	> 500	> 500	> 500	> 500	> 500	> 500	> 500	> 500	> 500	> 500	> 500	> 500
Does this meet DQO:	Yes	Yes	Yes	Yes	Yes	Yes	Yes	Yes	Yes	Yes	Yes	Yes	Yes	Yes	Yes

Standard Deviation of Penetration for Each Channel :	0.02	0.03	0.03	0.03	0.02	0.01	0.02	0.02	0.02	0.01	0.01	0.01	0.02	0.01	0.01
Data Quality Objective:	<0.10	<0.10	<0.10	<0.10	<0.10	<0.10	<0.10	<0.10	<0.10	<0.10	<0.30	<0.30	<0.30	<0.30	<0.30
Does this meet DQO:	Yes	Yes	Yes	Yes	Yes	Yes	Yes	Yes	Yes	Yes	Yes	Yes	Yes	Yes	Yes

Maximum observed particle concentration (#/cc):	12.9
Data Quality Objective: max. allowable conc. (#/cc):	< 14
Does this meet the DQO:	Yes, (applies to all channels)

Test No. 10079906

No Filter

Liquid-Phase

Particle Counts per Indicated OPC Channel (1-Minute Samples @ 7.1 L/min)

OPC Channel Number	1	2	3	4	5	6	7	8	9	10	11	12	13	14	15
Min. Diam. (um)	0.28	0.37	0.47	0.52	0.66	0.94	1.22	1.51	1.88	2.07	2.83	3.77	4.71	5.18	6.60
Max. Diam. (um)	0.37	0.47	0.52	0.66	0.94	1.22	1.51	1.88	2.07	2.83	3.77	4.71	5.18	6.60	9.43
Geo. Mean Diam (um)	0.32	0.42	0.49	0.58	0.78	1.07	1.36	1.68	1.97	2.42	3.26	4.21	4.94	5.85	7.89

ENTER DATA BELOW

U. Bckgrnd	1 Df	10-07-1999	15:50:02	0.2 CF	2	1	0	0	0	0	0	0	0	0	0	0			
U. Bckgrnd	1 Df	10-07-1999	15:52:08	0.2 CF	0	0	0	0	0	0	0	0	0	0	0	0			
Upstream	1 Df	10-07-1999	16:00:32	0.2 CF	9624	7213	1998	5082	12221	6720	4573	3984	2497	6971	2592	1208	536	897	338
Upstream	1 Df	10-07-1999	16:02:38	0.2 CF	10011	7672	2068	5297	12663	7047	4847	4402	2687	7105	2751	1367	551	921	362
Upstream	1 Df	10-07-1999	16:04:44	0.2 CF	10224	7739	2173	5575	13261	7088	4853	4324	2706	7356	2800	1317	549	958	407
Upstream	1 Df	10-07-1999	16:06:50	0.2 CF	10053	7965	2099	5565	13275	7097	5026	4379	2698	7200	2864	1360	603	914	379
Upstream	1 Df	10-07-1999	16:08:56	0.2 CF	10578	8155	2299	5674	13779	7447	5095	4498	2978	7594	2839	1386	569	935	410
Upstream	1 Df	10-07-1999	16:11:02	0.2 CF	10776	8204	2343	5822	13986	7389	5105	4546	2911	7616	2821	1363	614	972	406
Upstream	1 Df	10-07-1999	16:13:08	0.2 CF	10747	7989	2239	5747	13579	7567	5033	4440	2911	7390	2881	1345	590	1004	399
Upstream	1 Df	10-07-1999	16:15:14	0.2 CF	10759	8188	2341	5674	14003	7300	5071	4551	2930	7545	2827	1403	608	932	391
Upstream	1 Df	10-07-1999	16:17:20	0.2 CF	10685	8538	2290	5958	14020	7609	5327	4457	2925	7710	2988	1430	618	989	383
Upstream	1 Df	10-07-1999	16:19:26	0.2 CF	10777	8240	2238	5718	13689	7273	5096	4535	2875	7436	2955	1380	591	1000	382
U. Bckgrnd	1 Df	10-07-1999	16:32:31	0.2 CF	0	0	0	0	0	0	0	0	0	0	0	0	0	0	0
U. Bckgrnd	1 Df	10-07-1999	16:34:37	0.2 CF	0	0	0	0	0	0	0	0	0	0	0	0	0	0	0

ENTER DATA BELOW

D. Bckgrnd	2 Df	10-07-1999	15:51:05	0.2 CF	0	0	0	0	0	0	0	0	0	0	0	0	0	0	0
Downstream	2 Df	10-07-1999	16:01:35	0.2 CF	9797	7319	1973	5146	12547	6837	4862	4131	2587	7048	2727	1294	590	888	376
Downstream	2 Df	10-07-1999	16:03:41	0.2 CF	9888	7605	2016	5343	12828	6928	4844	4240	2622	7144	2809	1274	510	902	310
Downstream	2 Df	10-07-1999	16:05:47	0.2 CF	10128	7707	2140	5453	13081	7126	4970	4355	2734	7366	2815	1408	571	918	336
Downstream	2 Df	10-07-1999	16:07:53	0.2 CF	10424	7770	2237	5520	13348	7312	5079	4433	2780	7550	2833	1378	561	959	361
Downstream	2 Df	10-07-1999	16:09:59	0.2 CF	10537	8087	2225	5556	13661	7444	5192	4488	2878	7553	2823	1403	601	960	398
Downstream	2 Df	10-07-1999	16:12:05	0.2 CF	10452	8072	2141	5558	13437	7309	5062	4522	2782	7565	2889	1382	552	920	382
Downstream	2 Df	10-07-1999	16:14:11	0.2 CF	10726	8093	2197	5768	14018	7610	5144	4547	2925	7690	3100	1417	585	1058	362
Downstream	2 Df	10-07-1999	16:16:17	0.2 CF	10741	8152	2198	5655	13825	7536	5067	4496	2802	7646	2942	1367	591	1010	363
Downstream	2 Df	10-07-1999	16:18:23	0.2 CF	10842	8224	2198	5746	14100	7671	5254	4632	2916	7830	2988	1447	641	995	415
Downstream	2 Df	10-07-1999	16:20:29	0.2 CF	10311	7624	2134	5399	13295	7238	4925	4325	2774	7273	2791	1336	554	962	332
D. Bckgrnd	2 Df	10-07-1999	16:33:34	0.2 CF	1	0	0	0	0	0	0	0	0	0	0	0	0	0	0

Meas. Penetration	1.00	0.98	0.97	0.98	1.00	1.01	1.01	1.00	0.99	1.01	1.01	1.01	1.01	0.99	1.01	0.94
P100 correction values	1.00	1.00	1.00	1.00	1.00	1.00	1.00	1.00	1.00	1.00	1.00	1.00	1.00	1.00	1.00	1.00
Corrected Penetration	1.00	0.98	0.97	0.98	1.00	1.01	1.01	1.00	0.99	1.01	1.01	1.01	1.01	0.99	1.01	0.94
Corrected Efficiency (%)	0	2	3	2	0	-1	-1	0	1	-1	-1	-1	-1	1	-1	6

Data Acceptance Criteria:

Total Challenge Counts for Each Channel:	104234	79903	22088	56112	134476	72537	50026	44116	28118	73923	28318	13559	5829	9522	3857
Data Quality Objective:	> 500	> 500	> 500	> 500	> 500	> 500	> 500	> 500	> 500	> 500	> 500	> 500	> 500	> 500	> 500
Does this meet DQO:	Yes	Yes	Yes	Yes	Yes	Yes	Yes	Yes	Yes	Yes	Yes	Yes	Yes	Yes	Yes

Standard Deviation of Penetration for Each Channel :	0.05	0.06	0.07	0.06	0.06	0.05	0.05	0.05	0.07	0.05	0.06	0.06	0.08	0.07	0.10
Data Quality Objective:	<0.10	<0.10	<0.10	<0.10	<0.10	<0.10	<0.10	<0.10	<0.10	< 0.10	< 0.30	< 0.30	< 0.30	< 0.30	< 0.30
Does this meet DQO:	Yes	Yes	Yes	Yes	Yes	Yes	Yes	Yes	Yes	Yes	Yes	Yes	Yes	Yes	Yes

Maximum observed particle concentration (#/cc):	13.7
Data Quality Objective: max. allowable conc. (#/cc):	< 14
Does this meet the DQO:	Yes, (applies to all channels)

US EPA ARCHIVE DOCUMENT

Test No. 10089901
 Arrestor
 Liquid-Phase

Particle Counts per Indicated OPC Channel (1-Minute Samples @ 7.1 L/min)

OPC Channel Number	1	2	3	4	5	6	7	8	9	10	11	12	13	14	15
Min. Diam. (um)	0.28	0.37	0.47	0.52	0.66	0.94	1.22	1.51	1.88	2.07	2.83	3.77	4.71	5.18	6.60
Max. Diam. (um)	0.37	0.47	0.52	0.66	0.94	1.22	1.51	1.88	2.07	2.83	3.77	4.71	5.18	6.60	9.43
Geo. Mean Diam (um)	0.32	0.42	0.49	0.58	0.78	1.07	1.36	1.68	1.97	2.42	3.26	4.21	4.94	5.85	7.89

ENTER DATA BELOW

U. Bckgrnd	1 Dif	10-08-1999	06:37:36	0.2	CF	0	0	0	0	0	0	0	0	0	0	0				
U. Bckgrnd	1 Dif	10-08-1999	06:39:42	0.2	CF	0	0	0	0	0	0	0	0	0	0	0				
Upstream	1 Dif	10-08-1999	06:46:00	0.2	CF	10191	7390	2095	5367	12084	7199	4893	4046	2611	8154	3020	1330	620	1001	408
Upstream	1 Dif	10-08-1999	06:48:06	0.2	CF	10075	7674	2179	5315	12185	7249	4882	4167	2693	8159	2929	1354	652	1019	415
Upstream	1 Dif	10-08-1999	06:50:12	0.2	CF	10579	7728	2305	5449	12788	7592	4991	4317	2689	8429	3102	1379	613	1102	485
Upstream	1 Dif	10-08-1999	06:52:18	0.2	CF	10344	7832	2249	5426	12780	7693	5103	4388	2679	8515	3159	1425	661	1103	459
Upstream	1 Dif	10-08-1999	06:54:24	0.2	CF	10284	7563	2043	5460	12242	7330	4828	4170	2703	8130	3003	1376	605	1055	449
Upstream	1 Dif	10-08-1999	06:56:30	0.2	CF	9802	7332	2022	5194	12057	7087	4722	4087	2552	8039	3039	1339	593	998	401
Upstream	1 Dif	10-08-1999	06:58:36	0.2	CF	9575	7192	2083	5120	12064	7099	4698	4043	2594	7794	2933	1371	617	1037	420
Upstream	1 Dif	10-08-1999	07:00:42	0.2	CF	9430	6887	2021	4904	11494	6663	4575	3957	2407	7563	2816	1378	573	977	391
Upstream	1 Dif	10-08-1999	07:02:48	0.2	CF	9465	7120	1966	5000	11459	6893	4682	3972	2493	7710	2802	1351	598	1012	406
Upstream	1 Dif	10-08-1999	07:04:54	0.2	CF	9658	7120	2081	5087	12008	7002	4729	4016	2543	7699	2967	1381	606	1013	410
U. Bckgrnd	1 Dif	10-08-1999	07:15:24	0.2	CF	0	0	0	0	0	0	0	0	0	0	0	0	0	0	0
U. Bckgrnd	1 Dif	10-08-1999	07:17:30	0.2	CF	0	0	0	0	0	0	0	0	0	0	0	0	0	0	0

ENTER DATA BELOW

D. Bckgrnd	2 Dif	10-08-1999	06:38:39	0.2	CF	0	0	0	0	0	0	0	0	0	0	0	0	0	0	0
Downstream	2 Dif	10-08-1999	06:47:03	0.2	CF	7742	5328	1498	3651	8065	4314	2639	1830	1050	2868	718	178	58	46	8
Downstream	2 Dif	10-08-1999	06:49:09	0.2	CF	8202	5619	1587	3826	8507	4562	2730	1974	1182	2961	694	214	47	43	5
Downstream	2 Dif	10-08-1999	06:51:15	0.2	CF	7999	5521	1560	3840	8049	4358	2680	1891	1098	2965	652	174	50	62	10
Downstream	2 Dif	10-08-1999	06:53:21	0.2	CF	7674	5395	1443	3665	7905	4316	2600	1840	1083	2814	675	191	52	59	9
Downstream	2 Dif	10-08-1999	06:55:27	0.2	CF	7496	5213	1487	3670	7711	4243	2517	1800	1106	2671	707	163	64	38	5
Downstream	2 Dif	10-08-1999	06:57:33	0.2	CF	7318	5175	1465	3529	7604	4302	2479	1707	1065	2785	689	189	52	41	7
Downstream	2 Dif	10-08-1999	06:59:39	0.2	CF	7315	4930	1530	3534	7610	4064	2388	1717	983	2762	672	163	36	46	7
Downstream	2 Dif	10-08-1999	07:01:45	0.2	CF	7183	4903	1350	3296	7341	3974	2436	1758	1026	2720	611	166	49	37	4
Downstream	2 Dif	10-08-1999	07:03:51	0.2	CF	7253	5289	1509	3610	7634	4150	2487	1728	1017	2659	684	187	47	47	7
Downstream	2 Dif	10-08-1999	07:05:57	0.2	CF	7475	5126	1415	3605	7924	4255	2464	1827	1068	2721	650	158	42	39	14
D. Bckgrnd	2 Dif	10-08-1999	07:16:27	0.2	CF	0	0	0	0	0	0	0	0	0	0	0	0	0	0	0

Meas. Penetration	0.76	0.71	0.71	0.69	0.65	0.59	0.53	0.44	0.41	0.35	0.23	0.13	0.08	0.04	0.02
P100 correction values	1.00	0.98	0.97	0.98	1.00	1.01	1.01	1.00	0.99	1.01	1.01	1.01	0.99	1.01	0.94
Corrected Penetration	0.76	0.72	0.73	0.70	0.65	0.59	0.52	0.44	0.42	0.34	0.22	0.13	0.08	0.04	0.02
Corrected Efficiency (%)	24	28	27	30	35	41	48	56	58	66	78	87	92	96	98

Data Acceptance Criteria:

Total Challenge Counts for Each Channel:	99403	73838	21044	52322	121161	71807	48103	41163	25964	80192	29770	13684	6138	10317	4244
Data Quality Objective:	> 500	> 500	> 500	> 500	> 500	> 500	> 500	> 500	> 500	> 500	> 500	> 500	> 500	> 500	> 500
Does this meet DQO:	Yes	Yes	Yes	Yes	Yes	Yes	Yes	Yes	Yes	Yes	Yes	Yes	Yes	Yes	Yes

Standard Deviation of Penetration for Each Channel :	0.05	0.04	0.05	0.04	0.04	0.03	0.03	0.03	0.03	0.02	0.01	0.01	0.01	0.01	0.01
Data Quality Objective:	<0.10	<0.10	<0.10	<0.10	<0.10	<0.10	<0.10	<0.10	<0.10	<0.10	<0.30	<0.30	<0.30	<0.30	<0.30
Does this meet DQO:	Yes	Yes	Yes	Yes	Yes	Yes	Yes	Yes	Yes	Yes	Yes	Yes	Yes	Yes	Yes

Maximum observed particle concentration (#/cc):	13.3
Data Quality Objective: max. allowable conc. (#/cc):	< 14
Does this meet the DQO:	Yes, (applies to all channels)

Test No. 10089902

No Filter
Liquid-Phase

Particle Counts per Indicated OPC Channel (1-Minute Samples @ 7.1 L/min)

OPC Channel Number	1	2	3	4	5	6	7	8	9	10	11	12	13	14	15
Min. Diam. (um)	0.28	0.37	0.47	0.52	0.66	0.94	1.22	1.51	1.88	2.07	2.83	3.77	4.71	5.18	6.60
Max. Diam. (um)	0.37	0.47	0.52	0.66	0.94	1.22	1.51	1.88	2.07	2.83	3.77	4.71	5.18	6.60	9.43
Geo. Mean Diam (um)	0.32	0.42	0.49	0.58	0.78	1.07	1.36	1.68	1.97	2.42	3.26	4.21	4.94	5.85	7.89

ENTER DATA BELOW

U. Bckgrnd	1	Dif	10-08-1999	08:00:01	0.2	CF	4	0	0	0	0	0	0	0	0	0
U. Bckgrnd	1	Dif	10-08-1999	08:02:07	0.2	CF	2	2	0	0	0	0	0	0	0	0
Upstream	1	Dif	10-08-1999	08:08:25	0.2	CF	9793	7411	2066	5251	12653	7027	4692	4068	2749	7706
Upstream	1	Dif	10-08-1999	08:10:31	0.2	CF	9888	7554	2081	5250	12630	7078	4726	4264	2770	7798
Upstream	1	Dif	10-08-1999	08:12:37	0.2	CF	9797	7537	2097	5228	12775	7205	4871	4328	2844	7744
Upstream	1	Dif	10-08-1999	08:14:43	0.2	CF	9661	7147	2011	5159	12151	6938	4649	4120	2640	7419
Upstream	1	Dif	10-08-1999	08:16:49	0.2	CF	9566	7340	2099	5022	12239	6967	4495	4053	2795	7611
Upstream	1	Dif	10-08-1999	08:18:55	0.2	CF	9644	7324	2058	5142	12460	6860	4593	4121	2653	7638
Upstream	1	Dif	10-08-1999	08:21:01	0.2	CF	9890	7495	2071	5292	12642	7030	4808	4347	2783	7882
Upstream	1	Dif	10-08-1999	08:23:07	0.2	CF	10015	7632	2150	5423	12758	7163	4766	4351	2821	7813
Upstream	1	Dif	10-08-1999	08:25:13	0.2	CF	10525	8116	2254	5389	13368	7470	4985	4448	2943	8189
Upstream	1	Dif	10-08-1999	08:27:19	0.2	CF	10178	7743	2169	5549	13435	7480	4940	4391	2901	8089
U. Bckgrnd	1	Dif	10-08-1999	08:42:01	0.2	CF	2	0	0	0	0	0	0	0	0	0
U. Bckgrnd	1	Dif	10-08-1999	08:44:07	0.2	CF	1	2	0	0	0	0	0	0	0	0

ENTER DATA BELOW

D. Bckgrnd	2	Dif	10-08-1999	08:01:04	0.2	CF	0	0	0	0	0	0	0	0	0	0
Downstream	2	Dif	10-08-1999	08:09:28	0.2	CF	9943	7652	2047	5417	12845	7330	4943	4306	2851	7978
Downstream	2	Dif	10-08-1999	08:11:34	0.2	CF	10002	7732	2176	5233	12914	7195	4959	4234	2913	8044
Downstream	2	Dif	10-08-1999	08:13:40	0.2	CF	9453	7189	2058	5017	12112	6825	4573	4078	2739	7487
Downstream	2	Dif	10-08-1999	08:15:46	0.2	CF	9352	7234	2020	5068	12199	6778	4565	4081	2635	7609
Downstream	2	Dif	10-08-1999	08:17:52	0.2	CF	9626	7471	2017	5194	12412	7022	4623	4113	2840	7545
Downstream	2	Dif	10-08-1999	08:19:58	0.2	CF	9712	7430	2111	5112	12414	7108	4714	4300	2787	7697
Downstream	2	Dif	10-08-1999	08:22:04	0.2	CF	9730	7414	2141	5211	12570	7192	4844	4332	2827	7928
Downstream	2	Dif	10-08-1999	08:24:10	0.2	CF	10062	7794	2186	5552	13138	7244	4922	4384	2914	8192
Downstream	2	Dif	10-08-1999	08:26:16	0.2	CF	10061	7908	2190	5454	13057	7430	5031	4494	2823	8180
Downstream	2	Dif	10-08-1999	08:28:22	0.2	CF	10248	7850	2179	5516	13200	7427	4944	4384	2955	8015
D. Bckgrnd	2	Dif	10-08-1999	08:43:04	0.2	CF	2	0	0	0	0	0	0	0	0	0

Meas. Penetration	0.99	1.01	1.00	1.00	1.00	1.00	1.01	1.01	1.01	1.01	1.01	1.02	1.02	0.99	1.00	0.87
P100 correction values	1.00	1.00	1.00	1.00	1.00	1.00	1.00	1.00	1.00	1.00	1.00	1.00	1.00	1.00	1.00	1.00
Corrected Penetration	0.99	1.01	1.00	1.00	1.00	1.00	1.01	1.01	1.01	1.01	1.01	1.02	1.02	0.99	1.00	0.87
Corrected Efficiency (%)	1	-1	0	0	0	0	-1	-1	-1	-1	-1	-2	-2	1	0	13

Data Acceptance Criteria:

Total Challenge Counts for Each Channel:	98957	75299	21056	52705	127111	71218	47525	42491	27899	77889	29096	14289	6480	10707	4415
Data Quality Objective:	> 500	> 500	> 500	> 500	> 500	> 500	> 500	> 500	> 500	> 500	> 500	> 500	> 500	> 500	> 500
Does this meet DQO:	Yes	Yes	Yes	Yes	Yes	Yes	Yes	Yes	Yes	Yes	Yes	Yes	Yes	Yes	Yes

Standard Deviation of Penetration for Each Channel :	0.04	0.05	0.05	0.05	0.05	0.04	0.05	0.05	0.05	0.05	0.04	0.05	0.05	0.06	0.05	0.04
Data Quality Objective:	<0.10	<0.10	<0.10	<0.10	<0.10	<0.10	<0.10	<0.10	<0.10	<0.10	<0.10	<0.30	<0.30	<0.30	<0.30	<0.30
Does this meet DQO:	Yes	Yes	Yes	Yes	Yes	Yes	Yes	Yes	Yes	Yes	Yes	Yes	Yes	Yes	Yes	Yes

Maximum observed particle concentration (#/cc):	13.4
Data Quality Objective: max. allowable conc. (#/cc):	< 14
Does this meet the DQO:	Yes, (applies to all channels)

Test No. 10089903

Arrestor

Liquid-Phase

Particle Counts per Indicated OPC Channel (1-Minute Samples @ 7.1 L/min)

OPC Channel Number	1	2	3	4	5	6	7	8	9	10	11	12	13	14	15
Min. Diam. (um)	0.28	0.37	0.47	0.52	0.66	0.94	1.22	1.51	1.88	2.07	2.83	3.77	4.71	5.18	6.60
Max. Diam. (um)	0.37	0.47	0.52	0.66	0.94	1.22	1.51	1.88	2.07	2.83	3.77	4.71	5.18	6.60	9.43
Geo. Mean Diam (um)	0.32	0.42	0.49	0.58	0.78	1.07	1.36	1.68	1.97	2.42	3.26	4.21	4.94	5.85	7.89

ENTER DATA BELOW

U. Bckgrnd	1 Dif	10-08-1999	09:31:00	0.2 CF	0	0	0	0	0	0	0	0	0	0	0	0			
U. Bckgrnd	1 Dif	10-08-1999	09:33:06	0.2 CF	0	0	0	0	0	0	0	0	0	0	0	0			
Upstream	1 Dif	10-08-1999	09:39:24	0.2 CF	9714	7386	2137	5192	12410	7049	4651	4228	2742	7649	2799	1390	567	1062	407
Upstream	1 Dif	10-08-1999	09:41:30	0.2 CF	9542	7436	2072	5152	12423	7050	4723	4072	2855	7586	2840	1432	624	1053	452
Upstream	1 Dif	10-08-1999	09:43:36	0.2 CF	10393	7594	2113	5394	13174	7250	4860	4251	2856	7827	3061	1429	619	1033	465
Upstream	1 Dif	10-08-1999	09:45:42	0.2 CF	10226	7716	2181	5451	13054	7332	4840	4399	2889	7774	2908	1456	644	1094	446
Upstream	1 Dif	10-08-1999	09:47:48	0.2 CF	10251	7998	2345	5604	13566	7317	4868	4621	3011	8028	3027	1519	678	1086	473
Upstream	1 Dif	10-08-1999	09:49:54	0.2 CF	10330	7908	2265	5551	13260	7424	4927	4395	2960	8042	3051	1440	634	1141	424
Upstream	1 Dif	10-08-1999	09:52:00	0.2 CF	10166	7699	2154	5446	13151	7292	4788	4320	2819	7792	2834	1409	656	1048	444
Upstream	1 Dif	10-08-1999	09:54:06	0.2 CF	10043	7729	2134	5202	12807	7012	4761	4194	2841	7686	2904	1453	627	1052	418
Upstream	1 Dif	10-08-1999	09:56:12	0.2 CF	10058	7672	2120	5239	12966	6978	4889	4327	2880	7800	2871	1371	667	1061	441
Upstream	1 Dif	10-08-1999	09:58:18	0.2 CF	10000	7517	2138	5172	12466	7059	4639	4197	2792	7519	2888	1394	654	966	444
U. Bckgrnd	1 Dif	10-08-1999	10:06:42	0.2 CF	1	1	0	0	0	0	0	0	0	0	0	0	0	0	0
U. Bckgrnd	1 Dif	10-08-1999	10:08:48	0.2 CF	0	0	0	0	0	0	0	0	0	0	0	0	0	0	0

ENTER DATA BELOW

D. Bckgrnd	2 Dif	10-08-1999	09:32:03	0.2 CF	2	0	0	0	0	0	0	0	0	0	0	0	0	0	0
Downstream	2 Dif	10-08-1999	09:40:27	0.2 CF	7521	5199	1420	3672	8055	4154	2429	1777	1046	2527	600	199	47	47	3
Downstream	2 Dif	10-08-1999	09:42:33	0.2 CF	7665	5365	1524	3674	8116	4340	2561	1881	1092	2697	620	186	62	44	8
Downstream	2 Dif	10-08-1999	09:44:39	0.2 CF	7809	5457	1551	3811	8278	4319	2478	1875	1162	2563	654	183	42	46	5
Downstream	2 Dif	10-08-1999	09:46:45	0.2 CF	8070	5728	1505	3698	8612	4381	2531	1955	1162	2685	656	190	58	52	10
Downstream	2 Dif	10-08-1999	09:48:51	0.2 CF	8065	5740	1625	3852	8725	4441	2615	1936	1254	2882	682	185	56	47	7
Downstream	2 Dif	10-08-1999	09:50:57	0.2 CF	8056	5602	1627	3774	8607	4272	2517	1940	1195	2625	638	201	51	56	8
Downstream	2 Dif	10-08-1999	09:53:03	0.2 CF	7851	5543	1595	3690	8458	4310	2471	1822	1126	2624	622	192	42	49	6
Downstream	2 Dif	10-08-1999	09:55:09	0.2 CF	7781	5574	1537	3605	8363	4204	2459	1822	1139	2589	576	168	58	41	3
Downstream	2 Dif	10-08-1999	09:57:15	0.2 CF	7665	5530	1467	3738	8283	4194	2515	1754	1103	2615	629	197	46	56	7
Downstream	2 Dif	10-08-1999	09:59:21	0.2 CF	7408	5410	1541	3545	8063	4148	2405	1742	1109	2555	589	168	56	28	7
D. Bckgrnd	2 Dif	10-08-1999	10:07:45	0.2 CF	1	1	0	0	0	0	0	0	1	0	0	0	0	0	0

Meas. Penetration	0.77	0.72	0.71	0.69	0.65	0.60	0.52	0.43	0.40	0.34	0.21	0.13	0.08	0.04	0.01
P100 correction values	0.99	1.01	1.00	1.00	1.00	1.00	1.01	1.01	1.01	1.01	1.02	1.02	0.99	1.00	0.87
Corrected Penetration	0.78	0.72	0.71	0.69	0.65	0.59	0.51	0.43	0.39	0.34	0.21	0.13	0.08	0.04	0.02
Corrected Efficiency (%)	22	28	29	31	35	41	49	57	61	66	79	87	92	96	98

Data Acceptance Criteria:

Total Challenge Counts for Each Channel:	100723	76655	21659	53403	129277	71763	47946	43004	28645	77703	29183	14293	6370	10596	4414
Data Quality Objective:	> 500	> 500	> 500	> 500	> 500	> 500	> 500	> 500	> 500	> 500	> 500	> 500	> 500	> 500	> 500
Does this meet DQO:	Yes	Yes	Yes	Yes	Yes	Yes	Yes	Yes	Yes	Yes	Yes	Yes	Yes	Yes	Yes

Standard Deviation of Penetration for Each Channel :	0.03	0.03	0.04	0.03	0.03	0.02	0.02	0.02	0.02	0.02	0.01	0.01	0.01	0.01	0.01
Data Quality Objective:	<0.10	<0.10	<0.10	<0.10	<0.10	<0.10	<0.10	<0.10	<0.10	<0.10	<0.30	<0.30	<0.30	<0.30	<0.30
Does this meet DQO:	Yes	Yes	Yes	Yes	Yes	Yes	Yes	Yes	Yes	Yes	Yes	Yes	Yes	Yes	Yes

Maximum observed particle concentration (#/cc):	13.4
Data Quality Objective: max. allowable conc. (#/cc):	< 14
Does this meet the DQO:	Yes, (applies to all channels)