

US EPA ARCHIVE DOCUMENT

VERIFICATION TEST PLAN FOR
INDUCTION MIXERS MANUFACTURED BY THE MASTRRR COMPANY
FOR HIGH RATE DISINFECTION OF WET WEATHER FLOWS

Submitted to
NSF INTERNATIONAL, INC.

August 2000

ALDEN RESEARCH LABORATORY, INC.
30 Shrewsbury Street
Holden, MA 01520

VERIFICATION TEST PLAN FOR
INDUCTION MIXERS MANUFACTURED BY THE MASTRRR COMPANY
FOR HIGH RATE DISINFECTION OF WET WEATHER FLOWS

1.0 INTRODUCTION

1.1 General

The Environmental Technology Verification (ETV) program of the United States Environmental Protection Agency (EPA) was established to promote the marketplace acceptance of commercial-ready environmental technologies. The purpose is to provide credible third-party performance assessments of environmental technologies so that users, developers, regulators, and consultants can make informed decisions about such technologies. The ETV is not an approval process, but rather provides a quantitative assessment of technology performance as determined in accordance with this verification test plan.

A Wet Weather Technology "Pilot" was established to verify commercially available technologies used in the control and abatement of urban storm water runoff, combined sewer overflows (CSO) and sanitary sewer overflows (SSO). Experience has shown that the long disinfection contact time required for conventional wastewater treatment is not appropriate for the disinfection of CSO due to the infrequent peak flow rates that would require large tankage. However, disinfection of CSO can be achieved with less contact time by providing an increased disinfection dosage and intense mixing.

This Verification Test Plan (VTP) applies to induction mixers with motor speeds greater than 3,000 rpm and which are designed for submerged service in wet weather flows such as CSOs and SSOs. Details of the VTP applies to a specific mixer and the organization conducting the tests. Guidance is given on the execution of testing, data reduction, data analysis and reporting that will define the effectiveness of the mixer.

2.0 ROLES AND RESPONSIBILITIES OF INVOLVED ORGANIZATIONS

2.1 General

The Wet Weather ETV Pilot is administered through a cooperative agreement between EPA and a Verification Partner Organization. NSF International, Inc. (NSF) is the verification partner organization on the Wet Weather Flow (WWF) Technologies Pilot and administers the WWF Pilot in cooperation with the Urban Watershed Management Branch of the US EPA's National Risk Management Research Laboratory.

A Stakeholder Advisory Group (SAG) was formed to assist NSF and EPA in establishing priorities for the verification of wet weather technologies. The SAG consists of technology vendors, state and federal regulatory and permitting officials, technology users (POTWs and other municipal government staff), and technology enablers (e.g., consulting firms and universities) with an interest in the assessment and abatement of the impacts of wet weather flows.

A Technology Panel on High Rate Disinfection was established to guide the development of a protocol for the verification of high rate disinfection technologies, including induction mixers. The ETV Technology Panel will serve as a technical and professional resource during all phases of the verification of a mixer, including the review of Test Plans and Verification Reports, as requested by NSF and EPA.

2.2 U.S. Environmental Protection Agency (EPA)

The U.S. EPA's National Risk Management Research Laboratory provides administrative, technical and quality assurance guidance and oversight on all WWF pilot activities. EPA personnel are responsible for the following:

- review and approval of this Verification Test Plan

- review and approval of the Verification Report
- review and approval of the Verification Statement, and
- posting of the Verification Report and Statement on the EPA website.

2.3 NSF International

NSF International (NSF) is the U.S. EPA's verification partner on the Wet Weather Flow Technologies Pilot. In the context of this Verification Test Plan, NSF has selected a qualified Testing Organization, the Alden Research Laboratory, Inc. (Alden) to develop and implement the Verification Test Plan. In addition, NSF has the following responsibilities:

- review and approval of the Verification Test Plan
- oversight of Quality Assurance, including the performance of technical system and data quality audits, as described in the Quality Management Plan for the Wet Weather Flow Technologies ETV Pilot
- coordination of Verification Report peer reviews, including review by the Stakeholder Advisory Group and Technology Panel
- approval of Verification Report, and
- preparation and dissemination of Verification Statement

2.4 Alden Research Laboratory, Inc. (Alden)

The Field Testing Organization (FTO) is the Alden Research Laboratory, Inc. (Alden). High-rate induction mixers have previously been tested by Alden, which also has extensive experience with pilot testing and experimental design. Alden was founded in 1894 as part of Worcester Polytechnic Institute (WPI) and became a separate organization in 1986. Alden is nationally known for solving flow related engineering and environmental problems through a combination of laboratory testing (including flow meter calibrations and verification of equipment performance), computational fluid dynamics (CFD) and field testing. In addition to private corporations, Alden's clients have included

major governmental agencies such as the U.S. Nuclear Regulatory Agency, the U.S. Department of Energy and the U.S. Fish and Wildlife Service.

Alden is located in Holden, Massachusetts on about 25 acres of land used for experimental research and testing, and has a staff of about 40 people. The full address is:

Alden Research Laboratory, Inc.

30 Shrewsbury Street

Holden, MA 01520

Phone: (508) 829-6000

Facsimile: (508) 829-5939

e-mail: arlmail@aldenlab.com

The overall guidance for the test program will be provided by Dr. Mahadevan Padmanabhan ("Padu"), Vice-President. The Project Investigator in charge of conducting the tests will be Philip S. Stacy, Hydraulic Engineer. Both Padu and Phil will act as contact persons at Alden.

Dr. M. Padmanabhan ("Padu")

Phone Extension: 442; e-mail: padu@aldenlab.com

Philip S. Stacy

Phone Extension: 425; e-mail: pstacy@aldenlab.com

Primary responsibilities of Alden will include:

- preparation of site-specific Verification Test Plan, including revisions in response to comments made during the review period
- coordination with the manufacturer (vendor) of the mixer to be tested
- contracting with the hydraulic laboratory for implementation of the approved Verification Test Plan

- providing logistical support for the hydraulic laboratory, establishing a communication network, and scheduling and coordinating the activities for the verification testing
- overseeing and conducting the verification testing with the help of the hydraulic laboratory, in accordance with the approved Verification Test Plan
- managing, evaluating, interpreting and reporting on data generated during the verification testing, and
- preparation and review of a draft Verification Report

2.5 Vendor (mixer manufacturer)

The mixers to be tested are manufactured by:

The Mastrrr Company
1036 B Hercules
Houston, TX 77058

or

Post Office Box 890844
Houston, TX 77289
Phone: (800) 299-6836 or (281) 461-8999
Facsimile: (800) 226-2659 or (281) 461-8900
e-mail: mastrrr@c-com.net or mastrrr@airmail.net

All communication should be addressed to:

Mr. David Macaulay, President

The Mastrrr Company will supply three "GAS MASTRRR" Series 32 submersible chemical mixers to be tested that are of differing horse power and typical of their product line. All associated mounting hardware, chemical feed lines and other ancillary equipment needed for operation will be

supplied. A list of any special requirements, limitations and instructions shall also be provided, as should descriptive details about the capabilities and intended function of the mixers. Close communication with Alden is to be maintained to insure on time delivery of all equipment, consistent with the schedule in the Verification Test Plan. That document will be reviewed and approved by The Mastrrr Company (after any necessary changes have been made) prior to the start of testing.

One person will be supplied by the Mastrrr Company to provide technical support and to oversee mounting and operation of their mixers during testing. That person will certify that the mixers have been mounted and operated properly.

The Mastrrr will also review and comment on the Draft Verification Report and Verification Statement.

2.6 The S.O. Conte Anadromous Fish Research Center (CAFRC)

The USGS's Conte Anadromous Fish Research Center (CAFRC) will be the Hydraulic Laboratory where the verification testing will be conducted. CAFRC has previously participated in the testing of high rate induction mixers and has large indoor flumes and flow capacity which are uniquely suited for this purpose. Actual facilities to be used are described in Section 4 below.

CAFRC's responsibilities include but are not limited to the following:

- modify the test flume to provide the required dimensions and features
- provide steady flow to achieve the required velocities
- measure, evaluate and report on velocities and flows established during testing
- provide the needed electrical power for the mixers and sampling equipment
- assist with installation and repositioning of the sampling rig
- provide any needed QA/QC documentation for the flow and velocities

The contact person at CAFRC will be:

Mr. John Noreika
S.O. Conte Anadromous Fish Research Center
One Migratory Way
Post Office Box 796
Turners Falls, MA 01376
Phone: (413) 863-3839
Facsimile: (413)
e-mail: john_noreika@usgs.gov

2.7 Technology Panel on High Rate Disinfection

The ETV Technology Panel on High Rate Disinfection will serve as a technical and professional resource during all phases of the verification of a mixer, including the review of Test Plans and Verification Reports, as requested by NSF and EPA.

3.0 CAPABILITIES AND DESCRIPTION OF EQUIPMENT TO BE TESTED

3.1 General Description

The GAS MASTRRR series 32, is a versatile submersible chemical mixer used for water, wastewater, and CSO basin disinfection. Water applications include coagulant addition of alum or polymer as well as PH control. Drawings, photographs, and specifications provided by the Mastrrr Company are included in Appendix A.

The principle of operation is that rotation of the uniquely shaped propeller causes a reduction in pressure in the chamber surrounding the impeller shaft. Connecting a flow line to the port in the

chamber causes flow to be induced. This flow is propelled outward by the rotating propeller and mixed vigorously with the surrounding water (flow).

For disinfection applications, the GAS MASTRRR has a vacuum feed model for gas chemicals such as chlorine (CL₂) and sulfur dioxide (SO₂) for dechlorination. Liquid feed applications utilize a nonvacuum style model for liquid chemicals such as sodium hypochlorite and sodium bisulfite.

3.2 Series 32 Specifications

GAS MASTRRR series 32 units are available in 1/2 - 20 HP ranges. 1 to 20 HP units operate on 208, 230, or 460 VAC (specify voltage), 60 Hz, 3 phase. The motors are constructed of 316 stainless steel outer shell with Tivar (UHMW Polyethylene) cone and distributor. The power cord is 30 ft long, 4 conductor, 10 G.

For the purpose of ETV testing, the units will be 5 HP, 10 HP, and 20 PH, 460 VAC, 60 Hz, 3 phase.

Model # 32nv5	Serial #
Model # 32nv10	Serial #
Model # 32nv20	Serial #

3.3 Operating Requirements

Units must be submerged at all times while operating. Units will run between rated input and full load amps. The units will be supplied with a SAVVY 3 control panel. The panel is a Nema 3X stainless steel housed Allan Bradley disconnect panel with disconnect switch, control power transformer, HOA Switch, function lamps, combination starter, and motor monitor. Units will be supplied with a stainless steel guide rail and horizontal motor mounting bracket that is universal for all three HP ranges.

4.0 DESCRIPTION AND REQUIREMENTS FOR HYDRAULIC TEST FACILITY

4.1 General Site Arrangement

The S.O. Conte Anadromous Fish Research Center (CAFRC) is situated in the town of Turners Falls, MA, on the right (looking downstream) bank of the canal to the Cabot Hydroelectric Power Station. Water enters the building with the test flume from an inlet structure on the bank of the power canal. Rather than using the free surface intake structure, the inlet to a below ground conduit will be used. Flow from the buried conduit is controlled by a sluice gate in the building, and this flow is distributed to a forebay upstream of the test flume by an inlet chamber and floor diffuser.

Only one of the three flumes in the building will be used. That flume is longer, wider and deeper than needed, and therefore, false walls will be constructed to generate the desired test flume dimensions.

4.2 Test Channel

A rectangular channel section 7 ft wide with a water depth of 7 ft will be established for testing. To provide for a relatively uniform velocity distribution at the mixer, the length of the flume upstream of the mixer will be 20 ft, and the test channel entrance will be rounded to avoid flow separation. Upstream of the test channel entrance, the flow will be guided by a straight flume 10 ft wide and 32 ft long, with an upstream flow distributor, see Figure 1.

Downstream of the mixer, the test flume will be 28 ft long before expanding to the wider 10 ft flume width. Provisions will be made to accommodate installation of the mixer at the designated location in the test flume, in accordance with instructions and mounting hardware from the vendor.

A 25 point water (dye) sampling rig will be located along sections 5, 10, and 15 ft downstream from the mixer. Only one section will be sampled at one time, and provisions will be made for locating and moving the sampling rig.

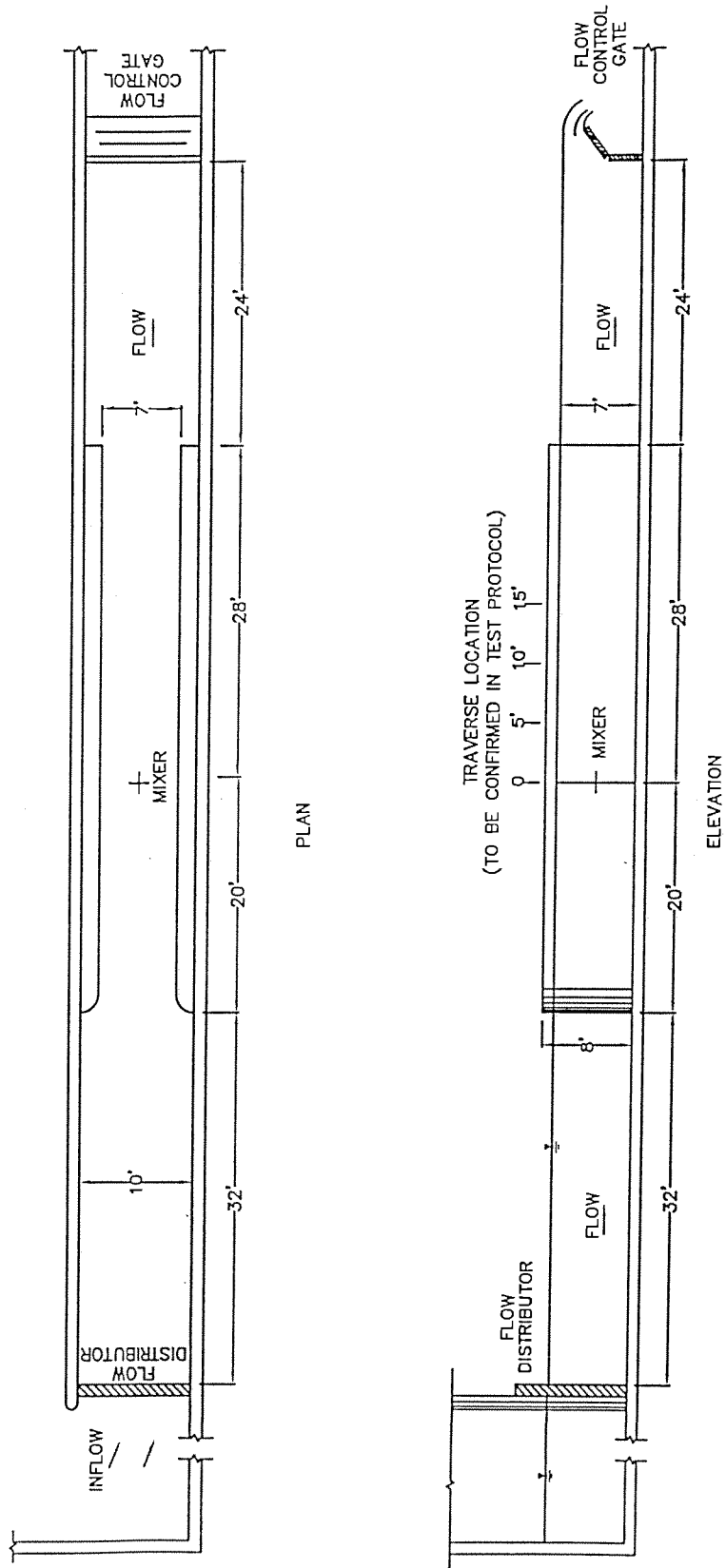

FIGURE 1 PLAN AND ELEVATION OF PROPOSED TEST SETUP

Adequate electrical power will be supplied to operated mixers of up to 20 hp and to supply power to the instrumentation used in the tests.

4.3 Flow Control

A flow and water level control weir and gate will be located 24 ft beyond the end of the test flume so that there are no effects on the flow distribution in the test flume caused by the flow control weir and gate. The lower portion of the weir will be fixed in the vertical position, and a moveable gate will be hinged along the top of the fixed weir to allow for flow variations while maintaining the water level. Relative portions of the weir and gate will be designed to cover the range of velocities specified herein.

To obtain the desired maximum velocity of 3 ft/sec, the test flume will be supplied with a maximum flow of 150 cfs. Lower velocities will be set by reducing the inflow with the upstream sluice gate and raising the weir/gate to maintain the water level. The flow used for a given test will be checked by independent measurements using a current meter traverse in the 7 ft x 7 ft cross-section just upstream of the mixer location, and instrumentation and access must be provided for such measurements. The current meter will record the longitudinal component (in the mean flow direction) of the velocity and the same meter or another meter must be able to record the turbulence intensity at selected locations in the cross-section.

4.4 Instrumentation For Dye Dilution

4.4.1 Dye Injection

Rhodamine WT will be used as the tracer dye. Rhodamine WT has low adsorption characteristics and is supplied at nominal 20% concentration by weight. Stock injection solutions will be prepared at two concentrations by serial dilution of the supplied solution with distilled water to allow the mixed concentrations to be similar to the expected 10 to 1 reduction in concentration of the mixer flow. The

injected dye quantity and concentration should produce a mixed concentration at the sampling location of about 10 to 20 ppb, assuring sufficient measurement accuracy in the linear response region of the fluorometer. Fluorescence is a function of water temperature, and test temperature variations from the water temperature during calibration should be taken into account.

4.4.2 Dye Sampling Rig

A sampling rig with five vertical arrays of sampling ports will be fabricated to accommodate the withdrawal ports, which will be located at 10%, 30%, 50%, 70%, and 90% of the total depth (center of five equal distances) at a longitudinal spacing selected to generate equal areas of sampling for each port, as shown in Figure 2. Thus, the sampling rig will have 25 suction tubes across the 7 ft x 7 ft cross-section. A continuous flow withdrawal from the ports will be accomplished by individual pumps and a part of the flow will be directed by valving arrangement to sample collection bottles, while the remainder will be returned to the flume.

4.4.3 Fluorometer

A Turner Designs Model 10 fluorometer will be used to measure dye concentration. The fluorometer is capable of detecting concentrations of about 0.01 ppb, such that a mixed concentration of 1 to 20 ppb provides sufficient measurement accuracy while maintaining a concentration sufficiently low to be undetectable by eye. Concentration of the samples are determined by fluorescence intensity measurements.

The Turner Designs Model 10 fluorometer has multiple settings to increase the range of measurable concentrations. Two settings are available, XI and XI00, having a 100 to 1 effect on output. Within each range, the sensitivity may be changed from XI to X31.6 in four equal steps, having about a 30-fold effect on output. The instrument span and zero offset are also adjustable to match the output to the measured concentration. The fluorometer will be set up to read in the upper one third output of the XI sensitivity scale to ensure good resolution for a wide concentration range.

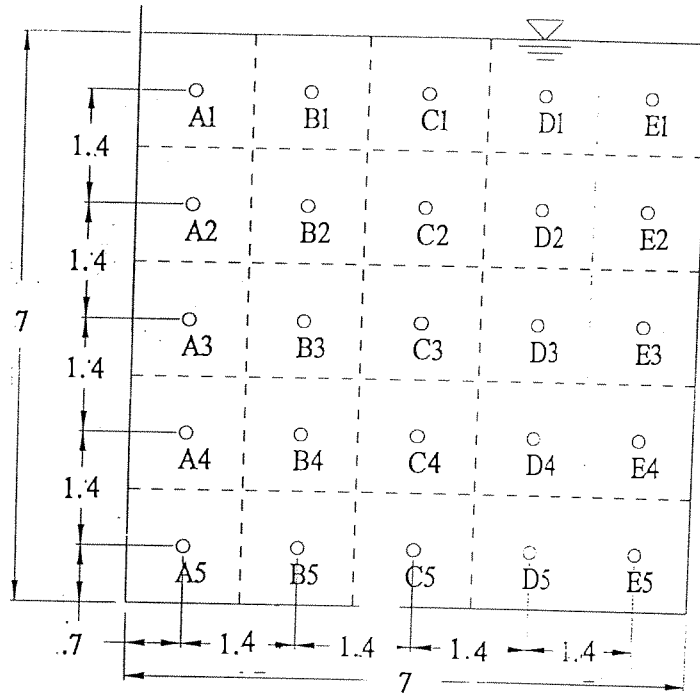

DIMENSIONS IN FT

FIGURE 2 LOCATION OF SAMPLING TUBES

5.0 TEST PROCEDURES: REQUIREMENTS AND GUIDELINES

5.1 Test Objectives

The kill for high rate disinfection is proportional to the mixing intensity, which in turn is a function of the power imparted into a given volume of water. A manufacturer of an induction type mixer may make claims about the mixing capabilities of their product and may provide values for parameters indicative of mixing intensity. However, there is not a standard way for calculating such parameters since the volume of water involved in the mixing is unknown. This Verification Test Plan establishes a method for determining the volume of process water affected by the induction mixer.

The objective of this testing is to characterize the performance of high rate induction mixers with respect to their ability to rapidly transfer a non-reactive tracer (instead of a chemical disinfectant) into a flowing body of clean water. Mixer performance will be characterized by the degree of tracer uniformity achieved over measured portions of the flow cross-section (the mixing zone) at various distances downstream from the mixer. This characterization will be for a range of flow velocities representative of those in wet weather flow collection and treatment facilities.

5.2 Test Conditions

Each verification test series will evaluate a single induction mixer under three velocities, namely 0.5, 1.25, and 3.0 ft/sec. For each test, the flow velocity is to be held steady and the water depth will be maintained at 7 ft. The sampling rig used to measure the extent of cross-sectional mixing will be located at 5, 10, and 15 ft downstream of the mixer, but only one sampling rig will be used and located at one distance for each test run.

Each verification test series will be for an induction mixer of a given power. Verification tests will be conducted for three mixers from each vendor, with horse powers of 5, 10 and 20.

5.3 Method and Materials

After a mixer has been installed and the desired flow conditions have been set and stabilized, the mixer will be operated with measured induction flow and measured injection of concentrated Rhodamine WT dye stock solution. An orifice meter will be used to measure the induction flow and a periodic volumetric check will be made of the dye metering pump flow. The metering pump will draw from the stock solution of dye and discharge into the hose that conveys water to the mixer. Amperage readings of the electrical power to the mixer will be recorded. Sufficient dye will be injected to insure that the mixed dye concentration is considerably above the detection limits of the fluorometer. The entire system will be operated for 5 minutes to insure steady state conditions before sampling will begin.

A single sampling rig (as described in Section 4.4.2) will be used. This rig and the associated sampling tubes and instrumentation will be moved to the next sampling location by rolling the entire system along rails installed on top of the test flume walls. The desired position of the sampling rig at distances of 5, 10 and 15 ft downstream of the mixer impeller will be pre-marked on the flume wall.

A commercial Turner Model 10 fluorometer will be used to determine the concentration of dye in each water sample collected. Some sample may be analyzed while the next test run is being conducted to insure that test procedures are working effectively. Most samples will be analyzed after all testing has been completed.

A velocity meter will be used to measure the flow distribution just upstream of the mixer location to verify that the velocity is relatively uniformly distributed over the 7 ft x 7 ft section and that the desired velocity has been obtained. Such measurements will be made once for each of the three hydraulic test conditions, while noting the position of the downstream weir/gate. Thereafter, a given flow condition will be reestablished by setting the gate/weir to that same position.

5.4 Test Procedures for Dye Concentration Evaluation

5.4.1 Dye Injection

Stock dye solution will be injected into the mixer flow by a constant displacement pump, whose variable stroke controls the dye release to achieve a mixed concentration of between 10 and 20 ppb. Figure 3 schematically shows the injection system. The injection pump and a 100 ml pipette with reduced area measuring stations will be supplied from a 20 liter Mariotte vessel (a vessel which maintains a constant inlet pressure on the injection pump regardless of liquid level in the vessel). Dye injection flow will be constant for each test and will be measured by the volumetric method. When the supply line from the Mariotte vessel is shut off via a valve, dye will be supplied to the pump solely from the pipette, which is to be a Class A vessel having a volume uncertainty of 0.1%. A digital timer with 0.001 second resolution will be started and stopped, as the meniscus of the dye passed the measuring locations on the pipette. Primary dye injection flow may be low, about 1 ml/sec, so that a secondary transport flow may be needed. A pair of calibrated rotameters will be used to measure the transport flow. The transport flow is introduced via a tee in the inlet pipe of the induced flow to the mixer pump.

Rather than having the mixers pull the induced flow due to the lower pressure just upstream of the impeller, a flow of about 20 gpm will be pumped to the 20 hp mixers and measured using a calibrated orifice plate meter section. Without pumping, use of the orifice meter would artificially reduce the induced flow. Proportionally lower flows will be pumped to the lower horsepower mixers, in accordance with vendor recommendations. The orifice meter pressure differential will be measured manually on a manometer board or with pressure cells. During testing, the flow to the mixer will be kept reasonably steady.

The mixer flow will be provided by a pump of approximately 2 hp, that withdraws flow from the channel approximately 4 ft to 6 ft upstream of the mixer. The dye will be injected into the intake pipe of the pump, which ensures that it is fully mixed with the flow delivered to the mixers.

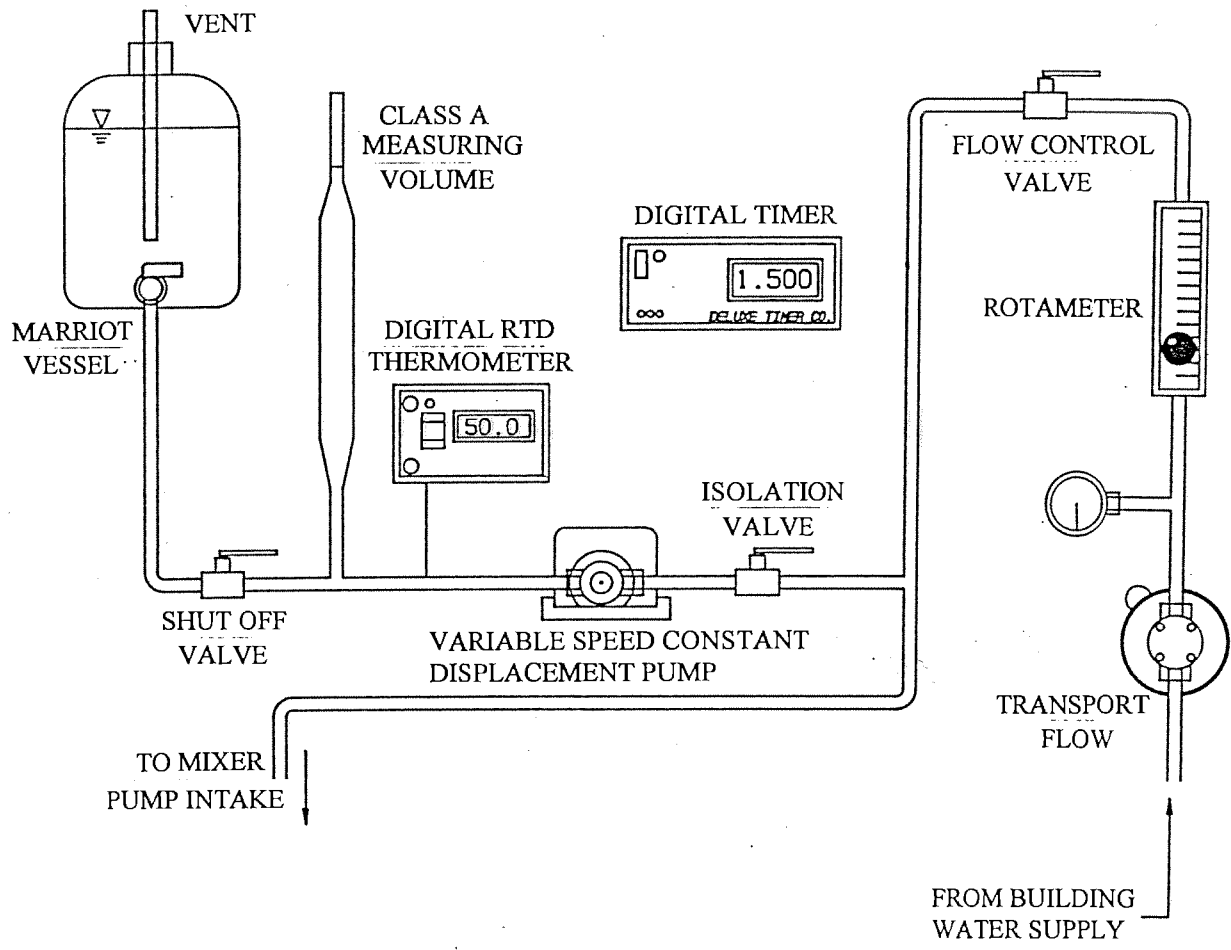

FIGURE 3 SCHEMATIC OF DYE INJECTION SYSTEM

Two valves will be used in the mixer flow line, the first directly downstream of the pump and the second downstream of the orifice meter section. The two valves are to be adjusted so that at the desired flow, the pressure within the meter section is positive; enough to prevent air from entering the lines but not high enough to inflate and cause the manometer fittings to leak.

5.4.2 Dye Sampling

A continuous flow will be withdrawn from each sample port using individual pumps having control valves and the majority of the flow will be discharged back to the test channel (downstream of the sampling ports). The balance of the sample flow will be piped through a second control valve to exit as a free jet. Twenty-five 1 liter bottles will be installed on a tray, which will be slid under the discharge jets of the sample lines to obtain simultaneous samples of all 25 points. The sample flows will be approximately equal, and a sample of about 10 minutes will be obtained at each location, adequate to produce a time average or typical concentration reading.

5.4.3 Dye Concentration

Fluorometer voltage output and the output from the two RTD thermometers, measuring water and instrument temperatures, will be recorded by a portable computer with a 12 bit analog to digital converter. A platinum resistance temperature sensor, mounted in an 1/8 inch diameter rod, will be used to measure the water sample temperature, so as to correct measured fluorometer voltage output to calibration water temperature. Fluorometer output, water temperature, and filter temperature will be read at eight hertz and, after 80 readings (about 10 seconds), the averages and standard deviations will be calculated, stored, and printed. During data acquisition, individual temperature and fluorometer readings will be displayed on the PC monitor for evaluation. Average fluorometer output, corrected to the calibration temperature, will also to be displayed versus time. Variation of the corrected output from the previous test point may be displayed as a percent to show trends on a magnified scale. After the fluorometer output reaches a steady value and sufficient data are

recorded for each sample, the 10 second readings at a given location will be averaged for concentration calculation.

5.4.4 Fluorometer Calibration

Two solutions of 2,000 ppb preliminary calibration solutions will be prepared from the stock injection solution at Alden with distilled water to expedite fluorometer calibration during testing. A calibration prior to the test should confirm that the two calibration solutions have the same concentration and to verify the fluorometer operation. The 2,000 ppb solutions will be used to prepare three calibration solutions of 10, 20, and 30 ppb (all concentrations are relative to the injected stock solution of 2×10^6 ppb) for fluorometer calibration. A linear regression analysis will be used to evaluate the calibration data consistency and to provide the means to calculate the sample concentration from the fluorometer average output.

5.5 Data Analysis

At each cross-section (5, 10 and 15 ft from the mixer) at which concentration data were obtained, the measured concentration C_i at each of the twenty five points in the cross section (see Section 5.4.3 for the procedure for concentration measurement) will be normalized by dividing by the uniform concentration C_u , which is defined as,

$$C_u = \text{tracer stock concentration} \times \text{tracer feed flow rate} / \text{flume water flow rate}$$

Note that the tracer stock concentration (fluorometer measurement) and the tracer feed flow rate (measured volumetrically, as the flow is drawn by a positive displacement pump) are known accurately (see Sections 5.3 and 5.4.1).

A normalized concentration of 1 at all points will represent perfect mixing. The normalized concentrations at the 25 points for each of the three cross-sections will be used to generate an isopleth diagram, as shown in Figure 4.

In addition, the standard deviation of the normalized concentrations for each cross-section will be computed and a plot of standard deviation with distance from the mixer will be obtained to indicate the mixer effectiveness.

5.6 Reporting

The final report will incorporate all data collected for each test, which include the flume test flow (from head over weir), mixer flow (orifice meter), dye stock injection flow (positive displacement pump), dye stock concentration (fluorometer measurement), and the individual concentration data for each of the twenty five points for each of the three cross sections (fluorometer measurements on each collected sample). The data will be presented in the Verification Report (final report) as tables, isopleth diagrams and plots of standard deviation of measured concentration versus distance from the mixer. Raw data in a tabular form (spread sheet format) will be included as an appendix in the report. The report will identify the tested mixer and its major characteristics, and describe the procedures and methods of testing, results, conclusions and recommendations, and will include photographs of the test facility and mixer setup. The report will also include instrument calibration data as an Appendix.

6.0 QUALITY ASSURANCE PROJECT PLAN (QAPP)

6.1 Alden QA Plan

The general Alden QA plan applicable for the study, is included as Appendix B of this report. Described in Appendix A are the project management and organization for QA, recording data and correspondence, file system, documentation with data log book and computer disks, and review procedure including procedure for documentation of revisions.

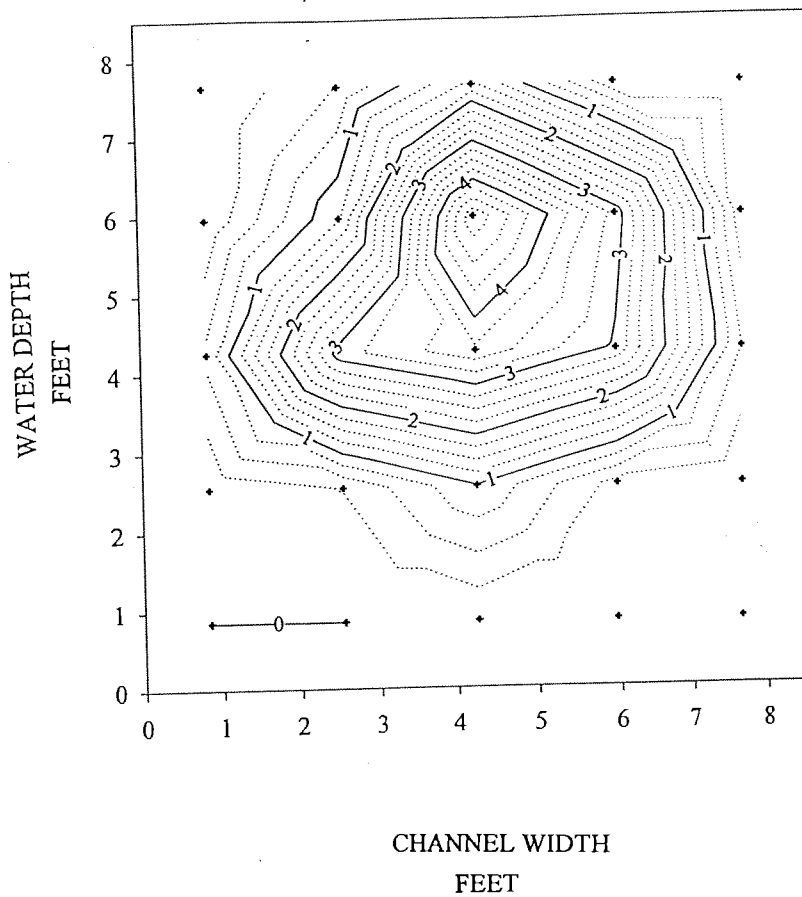

- DATA NORMALIZED BY DIVIDING POINT VALUES
BY THEORETICAL UNIFORM CONCENTRATION

FIGURE 4 TYPICAL TRACER CONCENTRATION
ISOPLETH DIAGRAM

6.2 Test Variables for QA Plan

Test variables subject to QA and uncertainty analysis are listed below:

TABLE 1 - TEST VARIABLES SUBJECT TO QA

Quantity/Item		Instrument (Calibration)	Number of Measurements **
A. Calibration of Instruments			
1.	Weir		
a.	Velocity Travers (4 ft upstream from mixer impeller)	ADV	25 locations in section, 3 readings/location
b.	Flume Width	Ruler	5 locations, 2 readings/location
c.	Water Depth	Pressure Cell calibrated at Alden	during calibration (sampling @ 8 hz)
d.	Weir Position	Ruler/Tape	3 readings/calibration
2.	Mixer Flow	Orifice Meter calibrated at Alden	10 points/calibrations
3.	Injector Pump (mixer)	Volumetric Displacement	see Section 5.4.1
4.	Dye Concentration	Fluorometer, Serial Dilution of Stock Dye (before and after testing)	see Section 5.4.4
5.	Water Temperature	Mercury Thermometer calibrated at Alden	
B. Test Variables (Measured for each test)			
I.	<u>Mixer</u>		
1.	Location	Ruler/Tape	Distance from impeller to start of flume test section (3 readings)

2.	HP	Watt and Volt Meters	3 readings during test
3.	Flow	Orifice Meter, DP Cell, Computer	During test (sampling @ 8 hz)
II.	<u>Flume</u>		
1.	Flow	Weir Position with Ruler/Tape	3 readings per test
2.	Water Depth (4 ft upstream from mixer impeller)	DP Cell, Computer	During test (sampling @ 8 hz)
3.	Water Temperature	Thermometer	3 readings per test
4.	Water Quality	Irrelevant as calibration uses same water	
III.	<u>Dye Injection</u>		
1.	Flow	Volumetric	3 readings per test
2.	Concentration (not measured)		
3.	Temperature	Thermometer	3 readings per test
IV.	<u>Dye Sampling</u>		
1.	Location	Ruler	Within 1/2", 2 readings per port
2.	Sample Concentration	Fluorometer	3 readings/bottle (each reading averaged over 10 seconds)
3.	Temperature	Thermometer	as above

** Number of repeats/readings listed will be confirmed by test engineers.

6.3 Uncertainty of Measurements (Bias and Precision)

Measurement uncertainties result from a combination of precision and bias uncertainties. Estimates of uncertainties of flow measurement in the flume will include uncertainties associated with the weir calibration (weir setting versus flow involves uncertainties due to velocity traversing, i.e.,

measurement of velocities, flume width and water depth) and uncertainties associated with weir setting. These uncertainties will be evaluated with input from CAFRC. Estimates of precision uncertainty for injection flow and concentrations will be made from the standard deviations of repeat measurements multiplied by the Student t factor to correct the standard deviation from the limited number of measurements to an estimate of the standard deviation with an infinite number of points. Bias uncertainty will be determined from comparative tests and Alden experience. The overall uncertainty will be reported as the sum of the precision and bias uncertainties at the 95% confidence level.

Injection flow measurement will have precision uncertainties from time and temperature measurements and bias uncertainties from time measurements and temperature effects on volume and density. The concentration measurement uncertainties need to include both fluorometer calibration uncertainty (from preparation of solutions, temperature effects and instrument errors due to electronic noise) and the data acquisition and reduction uncertainty.

6.4 Transmission of Data

The final report will include (as an Appendix) calibration data for the flume flow and instruments for injection flow and concentration measurement, raw data of flows and concentrations, revisions resulting from reviews, calculations, and a list of references. Any relevant data that are collected, reduced and/or calculated using a computer data acquisition system will be provided in the electronic form (spread sheets) in addition to hard copies.

7.0 SAFETY MEASURES

As the test flume at CAFRC is routinely used for testing with similar flows, conformance to electrical codes and confined space work procedures are followed. Precautions will be taken to avoid storing dye near the flume. Only the small quantity of dye stock for testing will be kept near the flume. Preparation of the stock will be restricted to confined areas with no consequences from inadvertent

spilling. Dye bottles carrying samples will be stored in containers and will be handled carefully to avoid spilling.

APPENDIX A
DRAWINGS, SPECIFICATIONS
AND PHOTOGRAPHS OF MIXERS

"GAS MASTRRR" SERIES 32

TECHNICAL SPECIFICATIONS 3-20 HP

DIMENSIONS (inches) / WEIGHT (lbs.)

HP	A	B	C	D	WEIGHT
3	27.5	23	4.5	7	75
5	27.5	23	4.5	7	75
7.5	28.5	24	4.5	7	85
10	30.5	25.5	5	8	95
15	33	28	5	8	105
20	35.5	30.5	5	8	115

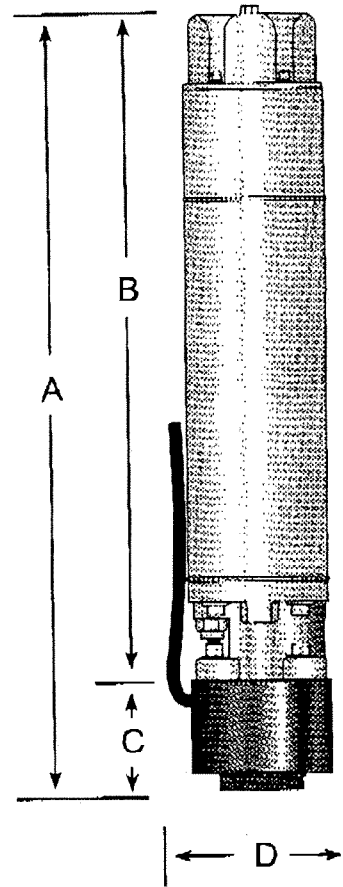

PERFORMANCE SPECIFICATIONS

HP	MAXIMUM GAS INDUCTION	MAXIMUM VACUUM (in. Hg)	MAXIMUM VACUUMED LIQUID FEED
3	2000 PPD	24	15 GPM
5	3000 PPD	25	25 GPM
7.5	4500 PPD	25	30 GPM
10	6000 PPD	26	40 GPM
15	8000 PPD	26	50 GPM
20	10,000 PPD	26	60 GPM

POWER CABLE SPECIFICATIONS

ROUND SUBMERSIBLE CABLE WITH NI OPRENE JACKET 4 WIRE
 3-5 HP #10 ga. 7.5-10 HP #10 ga. 15-20 HP #10 ga.

STANDARD POWER CABLE LENGTH 25' OPTIONAL LENGTHS AVAILABLE CONSULT FACTORY.

SUPPLY VOLTAGE OPTIONS

1 PHASE: 230 VAC 60Hz.
 3 PHASE: 200, 230, 460 VAC 60 Hz.

STANDARD SUPPLY VOLTAGE IS 60 Hz. 50 Hz. RANGES AVAILABLE CONSULT FACTORY

FEED PORT SIZE (INCHES)

3 - 7.5 HP QTY. 2 (1 1/2" NPT)
 10 - 20 HP QTY. 2 (2" NPT)

STANDARD FEED PORT QTY. 2 OPTIONAL FEED PORTS AVAILABLE UP TO QTY. 3

SPECIFICATION OR SUBMITTAL NOTES:

THE MASTRRR COMPANY

TECHNICAL DATA SHEET
 95-675-59

"HOT WAIT'S HOTLINE" 1-800-299-6836

"HOT FAX HOTLINE" 1-800-226-2659

DRAWING NOT TO SCALE

4/95:3-20TECH.DOC

"GAS MASTRRR" SERIES 32NV (3 - 20 IIP)
MATERIALS OF CONSTRUCTION
 316 STAINLESS STEEL SUBMERSIBLE FRANKLIN ELECTRIC MOTOR
 TIVAR (UHMW POLYETHYLENE) CONE & DISTRIBUTOR

PART	MATERIAL
MOTOR	316 STAINLESS STEEL
CONE/VACUUM CHAMBER	(TIVAR) UHMW POLYETHYLENE
DISTRIBUTOR	(TIVAR) UHMW POLYETHYLENE
VACUUM PORT	(TIVAR) UHMW POLYETHYLENE
SHAFT	TITANIUM SHEATHED
MECHANICAL SEALS	SILICONE CARBIDE
POWER CORD	CAROLPRENE SOOW TYPE 10/4 UL CSA APPROVED 316 S.S. SLEEVE & FERRULE
KINGSBURY THRUST BEARING	316 S.S./CARBON
LOWER ALIGNMENT BEARING SLEEVE	CARBON
HARDWARE	316 STAINLESS STEEL

MOTOR SPECIFICATIONS:

Hermetically sealed stator, UL 778 rec.
 Mineral oil filled/lubricated, water cooled
 Class F insulation
 Kingsbury Type Thrust Bearings

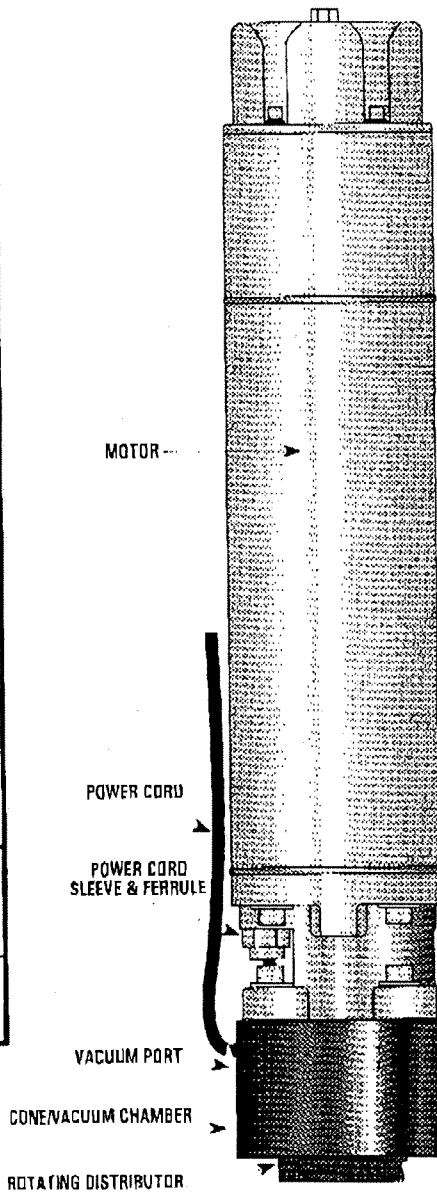

THE MASTRRR COMPANY

TECHNICAL DATA SHEET
 20-675-115C

"HOT WATTS HOTLINE" 1-800-299-6836
 "HOT FAX HOTLINE" 1-800-226-2659

DRAWING NOT TO SCALE
 996.316MOTOR.DOC

"GAS MASTRRR" APPLICATION GUIDE

The "GAS MASTRRR" Vacuum Induction Feeder Mixer draws the chemical product by inducing a vacuum and discharges the chemical into the outside periphery of the rotating distributor, then into the liquid process stream at high velocity determined by the diameter and RPM of the distributor and the characterized shape of the exit cone. The shape creates a rifled nozzle effect on the GPM Flow Rate liquid discharge and produces a spiraling rotating concentrated radial mix pattern from horizontal to 30° down and 100° wide. The work of the concentrated velocity discharge has a counter clock wise rotational (bottom view) effect on the mixing regime combined with creating a vortex perpendicular to the face of the distributor. This vortex is produced by the liquid GPM (Datum Tables) induced by the rotating distributor and directed toward the distributor face. The vortex length is given as "II".

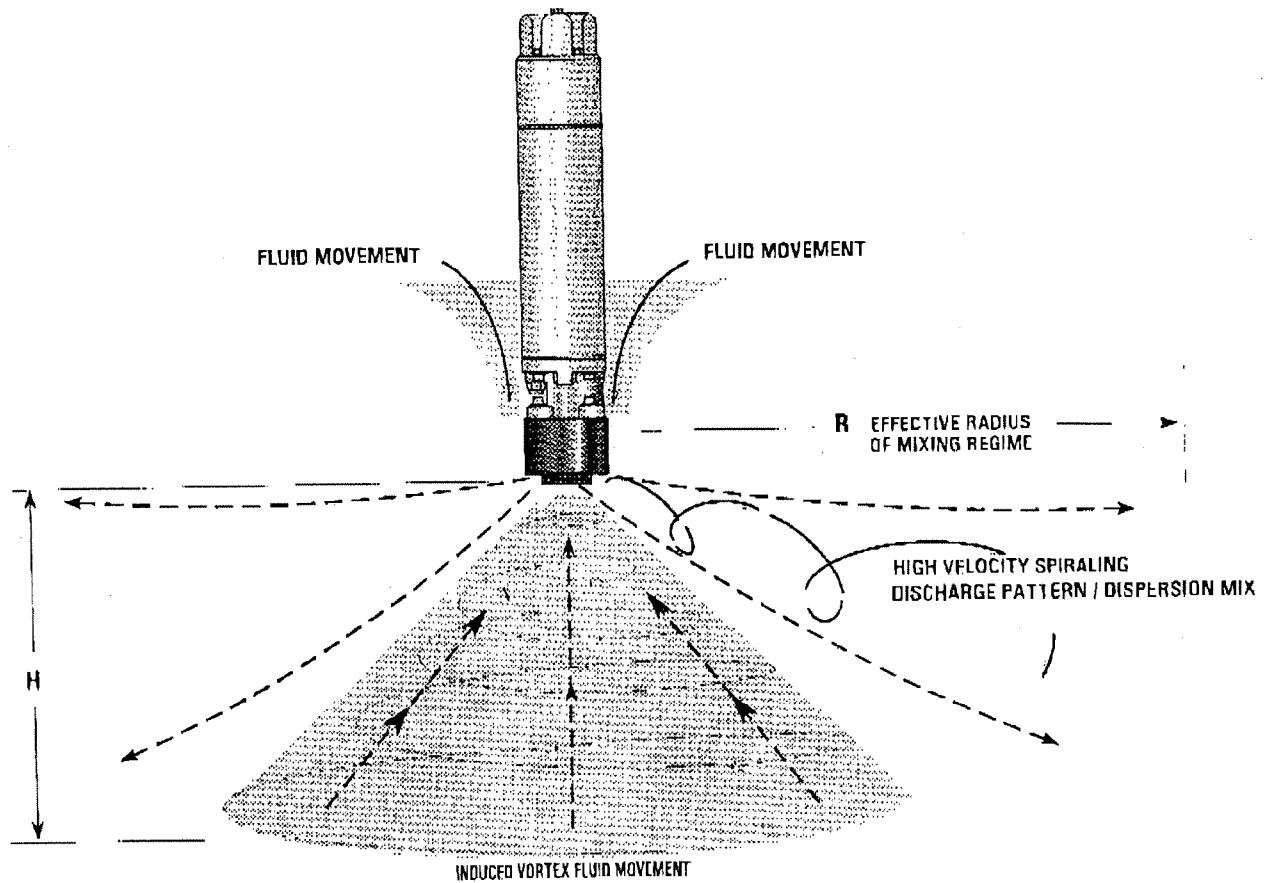

THE MASTRRR COMPANY

"GAS MASTRRR" SERIES 32 (3-20HP)
QUAD-CONE DISCHARGE/MIX PATTERN

**DISCHARGE MIX PATTERN
SIDE VIEW**

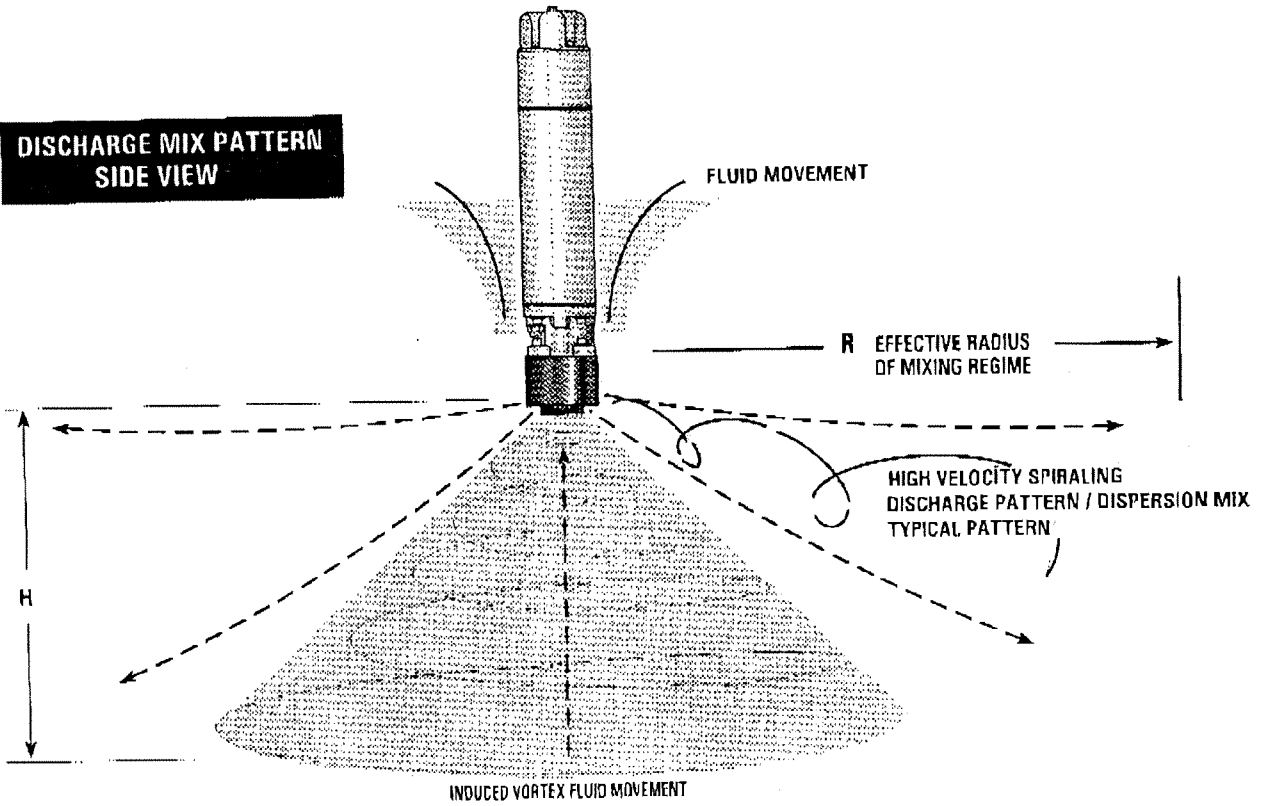

**DISCHARGE MIX PATTERN
BOTTOM VIEW**

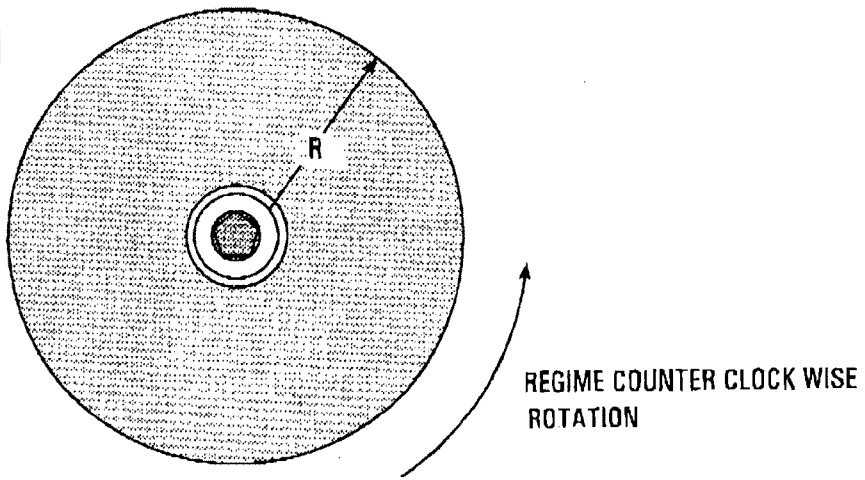

THE MASTRRR COMPANY

TECHNICAL DATA SHEET
APPLICATION & PERFORMANCE

"HOT WATTS HOTLINE" 1-800-299-6836
"HOT FAX HOTLINE" 1-800-226-2659

DRAWING NOT TO SCALE
S06-MIXXJA.DWG

**"GAS MASTRRR"
APPLICATION GUIDE TABLE**

HP	CHEMICAL FEED RATE "OPTIMUM FEED RATE NOT MAXIMUM"		f/s EXIT VELOCITY	GPM DATUM TABLES	FT. VORTEX "H"	FT. RADIUS (r)
	PPD	GPM				
1/2	100	3	50	300	2.5	2.5
1	200	4	52	330	3	3
2	500	8	60	580	3.5	5
3	1,200	15	88	745	4	6
→ 5	2,000	20	72	960	4	7
7-1/2	4,000	25	75	1,150	5	8
→ 10	6,000	30	79	1,325	6	9
15	8,000	40	83	1,870	6	10
→ 20	10,000	50	90	2,060	7	10

NOTES:

THE MASTRRR COMPANY

**TECHNICAL DATA SHEET
APPLICATION & PERFORMANCE**

"GAS MASTRRR" SERIES 32/36
REMOVABLE POWER CABLE LEAD ASSEMBLIES
DIMENSIONS AND MATERIALS LIST
TECHNICAL DATA SHEET # 96-675-109

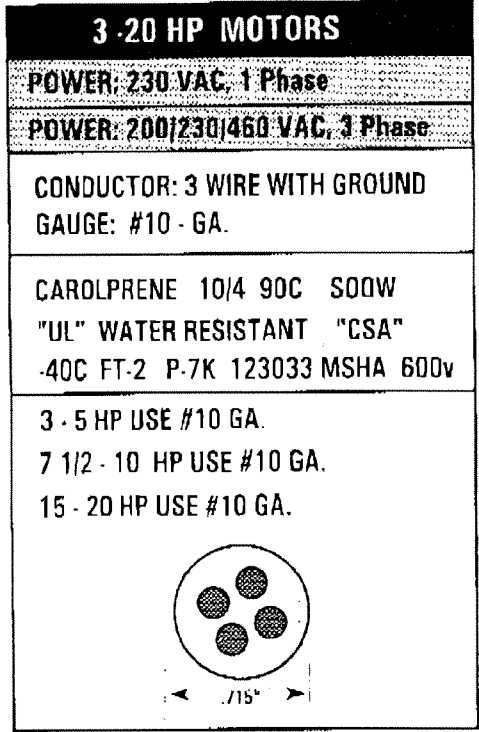
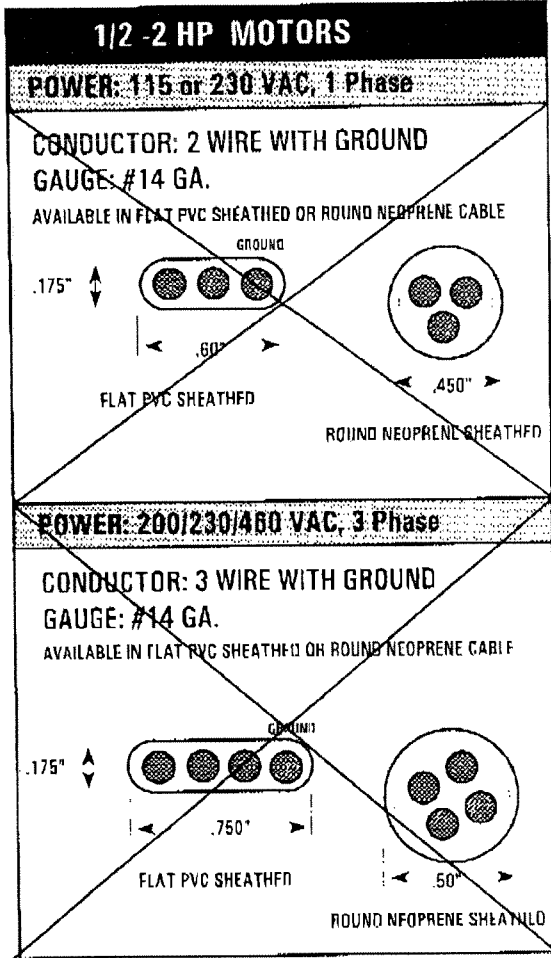

SPECIFY CABLE LENGTH 30 _____ FEET.

LEAD SLEEVE AND FERRULE MADE OF #316 STAINLESS STEEL.

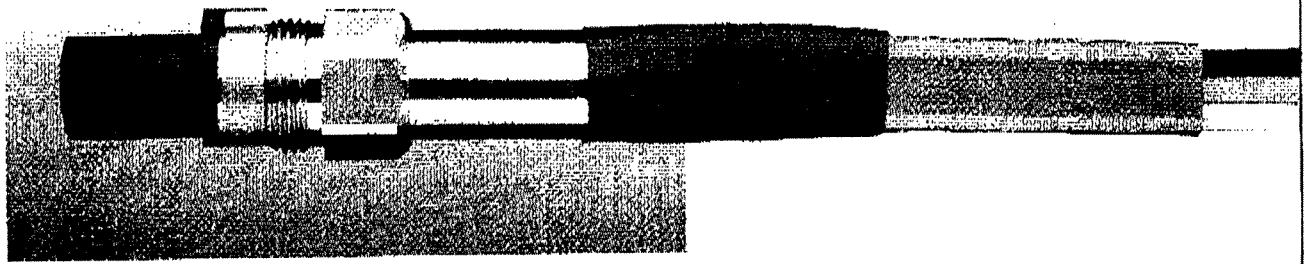

THE MASTRRR COMPANY

TECHNICAL DATA SHEET
96-675-109

"HOT WATTS HOTLINE" 1-800-299-6836
 "HOT FAX HOTLINE" 1-800-226-2659

DRAWING NOT TO SCALE
676 POWERCOR.DOC

**SERIES 32 460 VOLT
THREE PHASE MOTOR SPECIFICATIONS**

	HP	1	2	3	5	7-1/2	10	15	20
ALL FRANKLIN MOTORS HAVE CLASS F INSULATION	VOLTS	460	460	460	460	460	460	460	460
	HZ	60	60	60	60	60	60	60	60
	S.F.	1.4	1.25	1.15	1.15	1.15	1.15	1.15	1.15
	AMPS	2.0	3.4	7.5	7.5	10.9	14.2	20.5	26.9
RATED INPUT	WATTS	1070	2150	4700	4700	7000	9400	13700	18100
	AMPS	2.4	4.1	8.3	8.3	12.3	16.1	23.7	30.3
MAXIMUM (S.F. LOAD)	WATTS	1440	2700	5400	5400	8000	10800	15800	20900
	RES.	21.2-23.0	9.7-12.0	3.53-4.37	3.53-4.37	2.17-2.68	1.76-2.17	1.07-1.32	76-94
EFFICIENCY %	S.F.	72.5	69.5	79.5	79.5	79.8	79.2	81.0	82.0
	F.L.	70.0	69.5	79.1	79.1	80.0	79.4	81.5	82.3
	3/4	66.0	67.4	77.2	77.2	78.7	78.0	80.2	81.6
POWER FACTOR %	S.F.	79.4	84.4	82.0	82.0	83.0	85.5	84.9	86.8
	F.L.	69.0	79.0	79.5	79.5	80.5	83.2	82.8	84.8
	3/4	60.0	71.2	73.8	73.8	73.8	77.2	76.5	79.5
LOCKED ROTOR	AMPS	13.5	23	43	43	65	86	133	181
KVA	CODE	M	L	H	H	H	H	H	J
CURCUT BREAKER OR FUSE AMPS	STD.	8	15	25	25	30	40	60	80
	DELAY	3	5	10	10	15	20	30	35

THE MASTRRR COMPANY	TECHNICAL DATA SHEET 95-675-56
----------------------------	--

"HOT WATTS HOTLINE" 1-800-299-6836
 "HOT FAX HOTLINE" 1-800-226-2659

5/95:460v3ph.doc

GAS MASTRRR NONVACUUM FEED SYSTEM TYPICAL FEED HOSE ARRANGEMENT

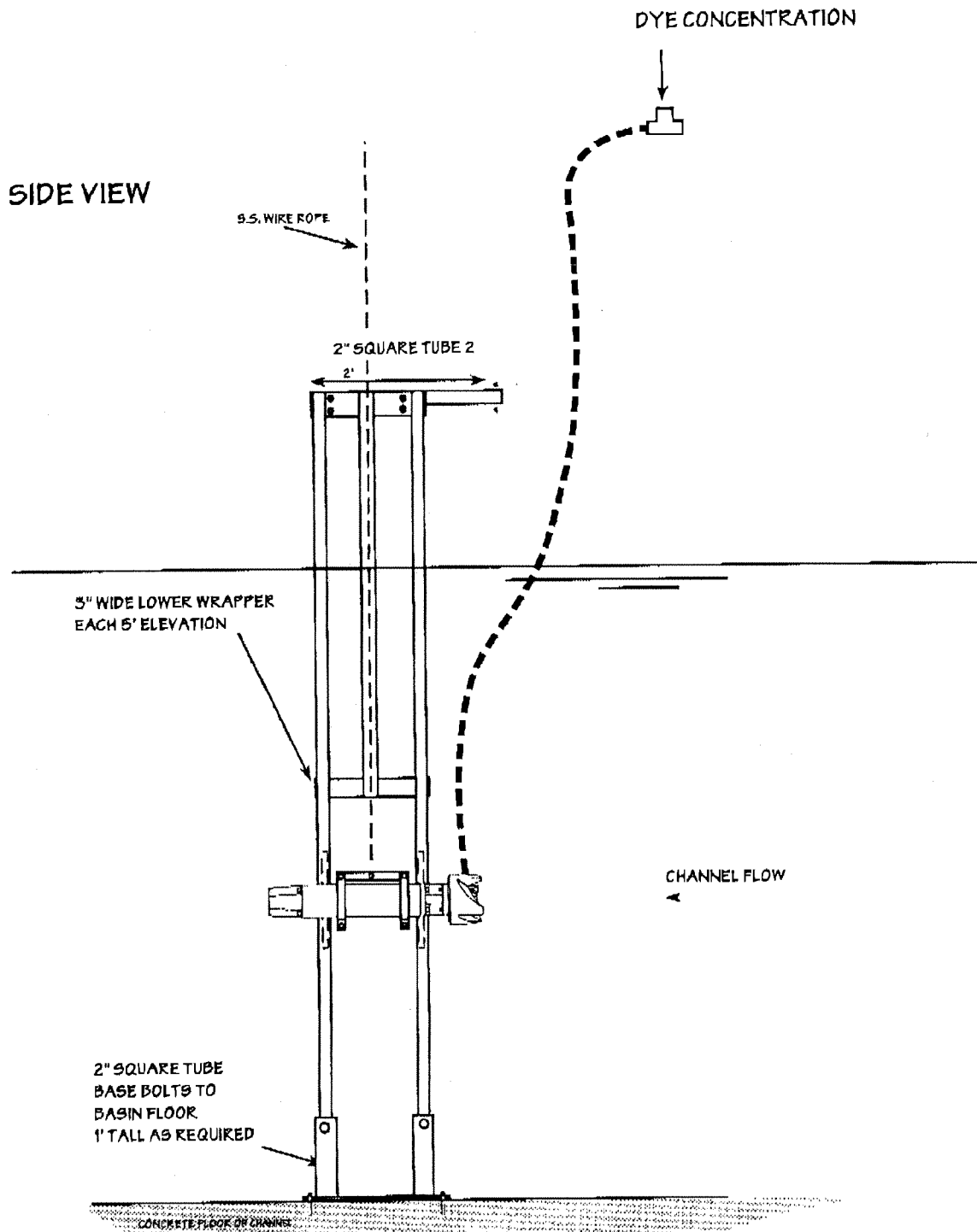

THE MASTRRR COMPANY

This drawing is the property of THE MASTRRR COMPANY and use and the design of THE MASTRRR COMPANY. No part of this drawing shall be made, used, copied, or transmitted, traced, reproduced, or disclosed without the written permission of THE MASTRRR COMPANY. This drawing shall be returned to THE MASTRRR COMPANY upon request.

SHOP DRAWING # NAP-2

316 STAINLESS STEEL HORIZONTAL BRACKET SHOP DRAWING # UGR-6A

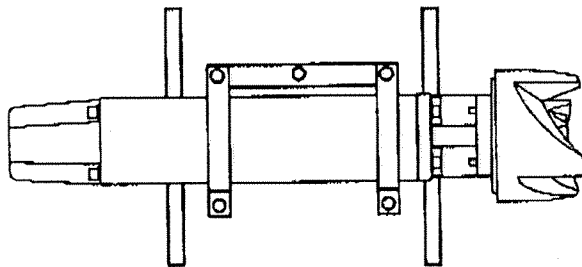
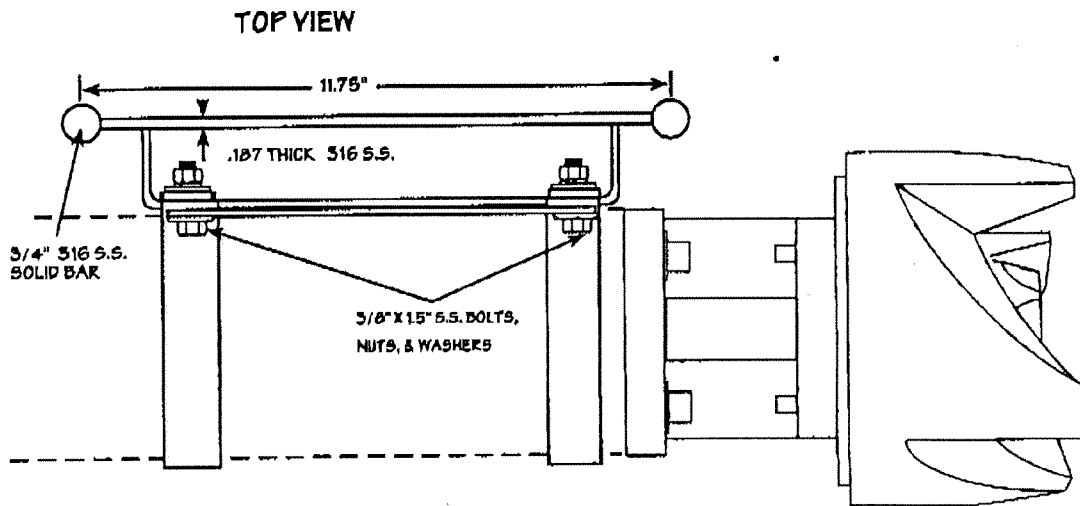
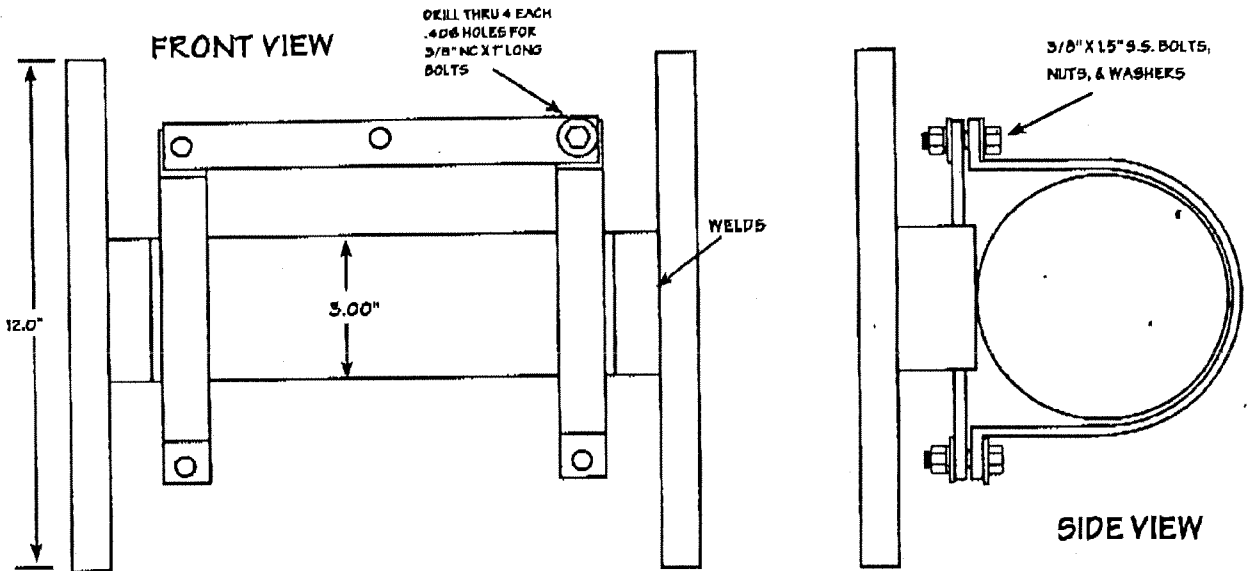

LOCATIONS:

MATERIALS 316 S.S.

SAVVY 3

Pump Motor Status Monitors/Controllers

DESCRIPTION

The SAVVY 3 pump motor status monitor and controller panel is designed for use with your GAS MASTRRR series 32 submersible units. The SAVVY 3 panel may be modified to control and monitor series 35F and 3505F inline mixers with TEFC motors.

The panels are Nema 4X rated 316 stainless steel enclosures for indoor/outdoor service. The panels are supplied standard with an Allen-Bradley combination starter with adjustable amperage trip heaters, Westinghouse motor circuit protector and disconnect switch. Motor monitoring features include high and low voltage, voltage imbalance, phase loss or reversal, overload and underload amperage trips, and time delay restart. The panel includes alarm and on off status lamps, HOA switch, start push button, mechanical run time hour meter, lightning arrester and transient suppressor module and are all tested and ready for service with your induction mixer.

All SAVVY 3 control panels shall be grounded to the induction unit guide rails.

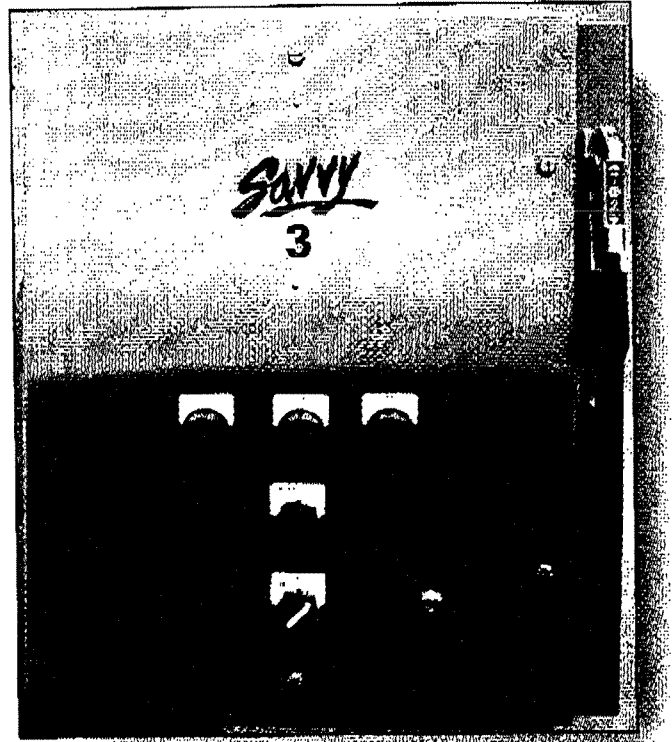
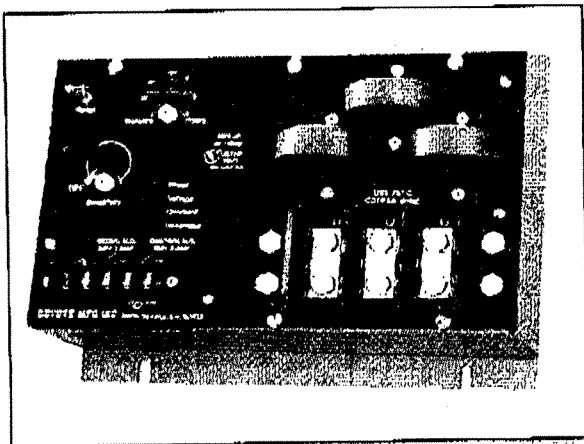

FEATURES

- NEMA 4X 316 stainless steel enclosure
- Utilizes a UL Listed & CSA certified ALLEN-BRADLEY starter and disconnect panel
- High and low amperage trip settings field adjustable LED indicators
- High and low voltage trip settings LED indicator
- Phase loss and reversal protection LED indicator
- Motor run-time hour meter (mechanical)
- Terminal blocks with remote alarm contacts and remote monitoring capability
- Time delay restart

*UL LISTED CONTROL PANEL AND COMPONENTS

SAVVY 3, ENCLOSURE DIMENSIONS

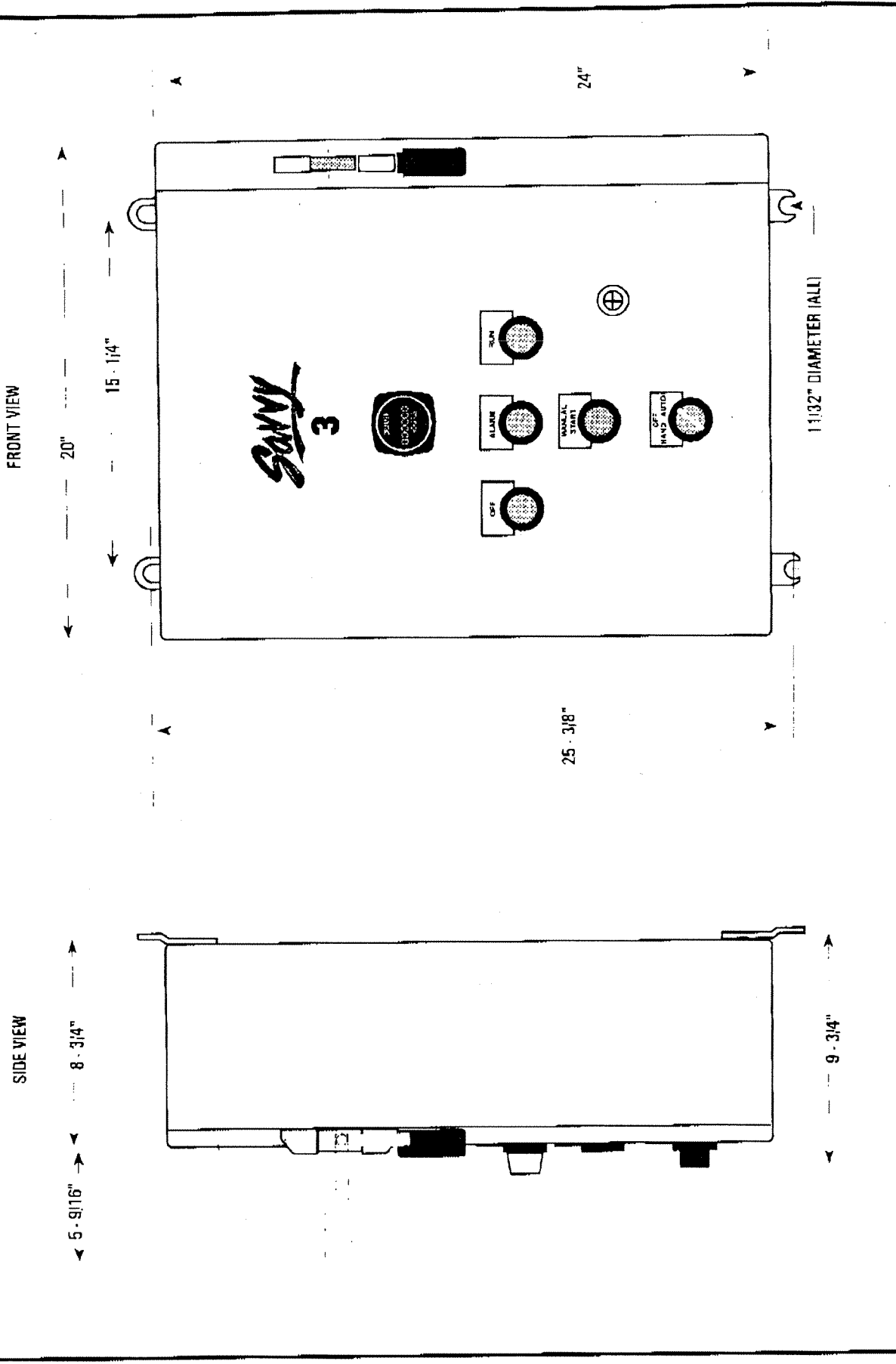

Technical Data Sheet # 98-675-154

THE MASTRRR COMPANY 1(800) 299-6836

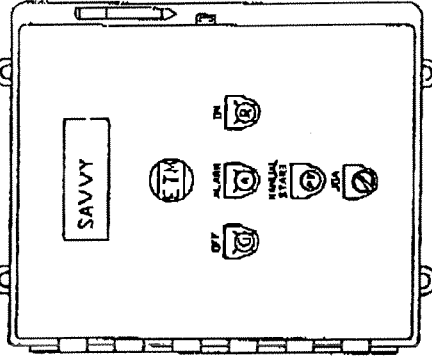
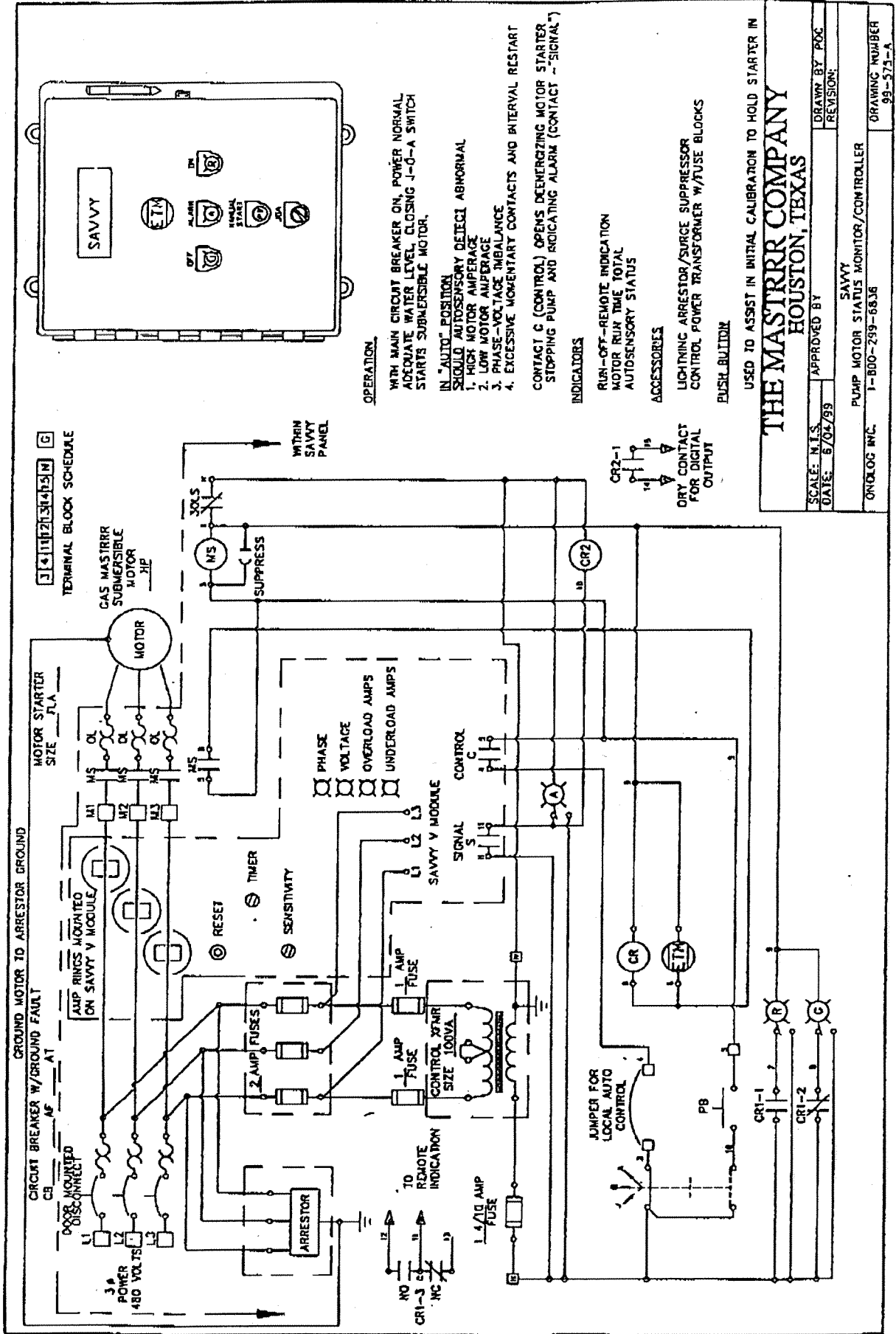

OPERATION.

WITH MAIN CIRCUIT BREAKER ON, POWER NORMAL
 ADEQUATE WATER LEVEL CLOSING J-O-A SWITCH
 STARTS SUBMERSIBLE MOTOR.

IN "AUTO" POSITION

- 1. SHOULD AUTOMATICALLY DETECT ABNORMAL
- 2. HIGH MOTOR AMPERAGE
- 3. LOW MOTOR AMPERAGE
- 4. PHASE-VOLTAGE IMBALANCE
- 5. EXCESSIVE MOMENTARY CONTACTS AND INTERVAL RESTART

CONTACT C (CONTROL) OPENS DEENERGIZING MOTOR STARTER
 STOPPING PUMP AND INDICATING ALARM (CONTACT --SIGNAL--)

INDICATORS

RUN-OFF--REMOTE INDICATION
 MOTOR RUN TIME TOTAL
 AUTODSENSORY STATUS

ACCESSORIES

LIGHTNING ARRESTOR/SURGE SUPPRESSOR
 CONTROL POWER TRANSFORMER W/TUSE BLOCKS
 PUSH-BUTTONS

USED TO ASSIST IN INITIAL CALIBRATION TO HOLD STARTER IN

THE MASTRRR COMPANY
HOUSTON, TEXAS

SCALE: M.S.	APPROVED BY	DRAWN BY POC
DATE: 8/04/99	REVISION:	
ONOLOG INC.		DRAWING NUMBER
SAVVY		99-573-A
PUMP MOTOR STATUS MONITOR/CONTROLLER		
1-800-239-6836		

GAS MASTER

CHEMICAL INDUCTION FEEDER MIXERS

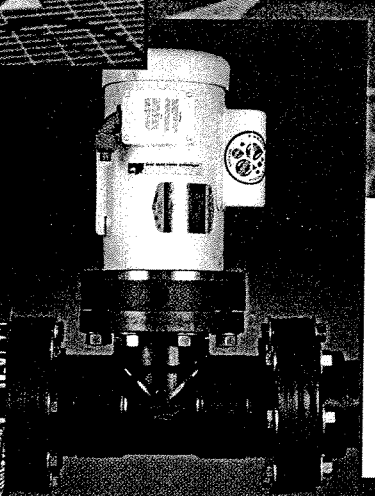
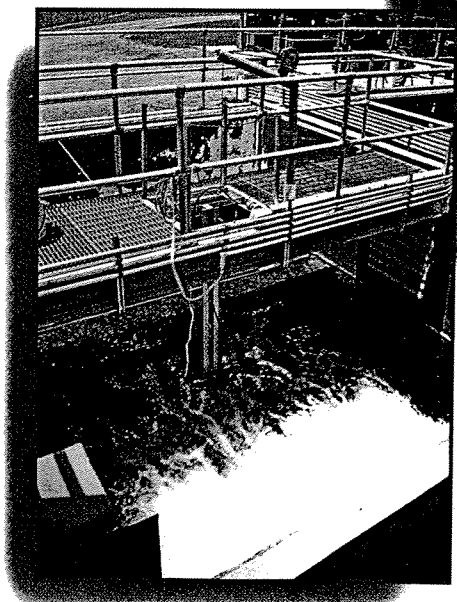
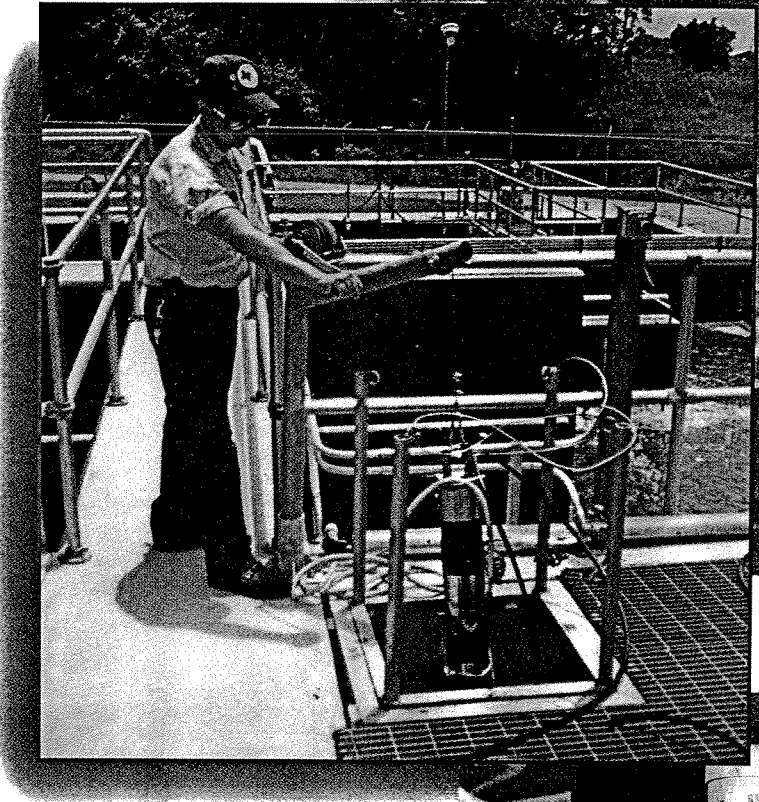

CHEMICAL VACUUM INDUCTION FLASH MIXING

Innovations in vacuum induction flash mixing have provided engineers, municipalities, and industries with versatile options for designing new, replacing, and or retrofitting existing chemical feed systems. As an advanced alternative to old style ejector/diffuser vacuum feed systems, chemical induction flash mixers are a simple and cost effective method of vacuum inducing and flash mixing chemicals into basins, channels, open vessels, tanks, and pipelines.

The GAS MASTRRR eliminates the need for water supplies, booster pumps, ejectors, diffusers, and mechanical mixers. The submersible series 32 and 36, flanged inline 32F, 33, and 35F are designed to vacuum induct and flash mix gas and or liquid chemicals with superior velocity gradient mixing intensity. The units incorporate a unique non-fouling designed vacuum cavity distributor made of an extremely abrasive and chemical resistant UHMW Polyethylene material called TIVAR*. This distributor rotates at 3450 RPM, creating a strong vacuum which safely pulls the chemical from the source to the point of application and flash mixes it directly into the process stream at velocities up to and exceeding 60 FPS.

The multiple feed port design allows for gas, liquid, or a combination of both to be flash mixed from a single unit. Applications include water and wastewater disinfection with chemicals such as chlorine gas or sodium hypochlorite solution and dechlorination with sulfur dioxide gas or sodium bisulfite solution. Water treatment applications for vacuum feed of ozone, anhydrous ammonia, chlorine or carbon dioxide gas, liquid feed of alum, polymer, hydrogen peroxide, potassium permanganate, acids, and many other chemicals.

A unique feature of the GAS MASTRRR is the ability to custom shape the distributor for applications such as polymer feed where low vacuum shear is required or ozone induction where super high vacuum shear is a necessity.

The GAS MASTRRR series of submersible and flanged induction units are competitively priced with ejector/diffuser systems and inline static mixers. The units have a standard one year limited warranty and or backed with an exclusive factory exchange program for long-term customer support.

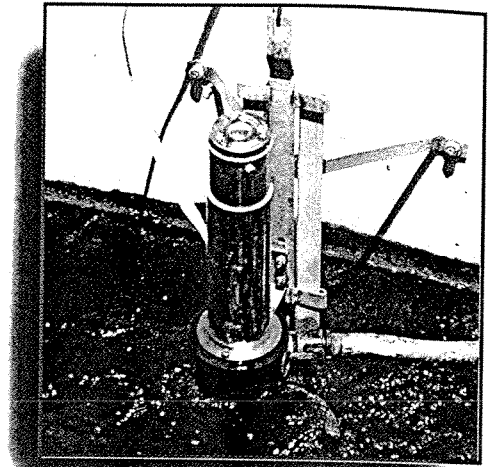

GAS MASTRRR FEATURES

- ELIMINATES THE EJECTOR, WATER SUPPLY, BOOSTER PUMP, DIFFUSER, AND MECHANICAL MIXER
- INSTANTANEOUS CHEMICAL FLASH MIXING
- SUPERIOR VELOCITY GRADIENT MIXING INTENSITY
- SAFE VACUUM FEED OPERATION
- SUBMERSIBLE AND FLANGED INLINE DESIGNS
- GAS FEED TO 10,000 PPD PER UNIT
LIQUID FEED TO 150 GPM PER UNIT
- U.S.A. MANUFACTURED MOTORS
- INNOVATIVE "NON-FOULING" VACUUM CAVITY DISTRIBUTOR OF EXTREMELY ABRASIVE/CHEMICAL RESISTANT TIVAR* CONSTRUCTION
- EASILY INSTALLS WITH NEW AND OR RETROFITS TO EXISTING CHEMICAL FEED SYSTEMS

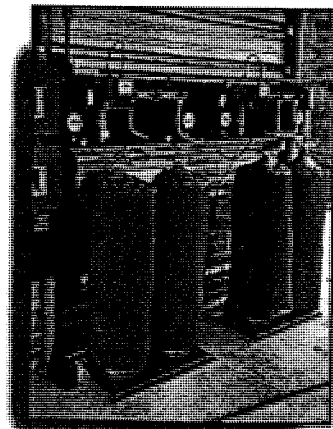
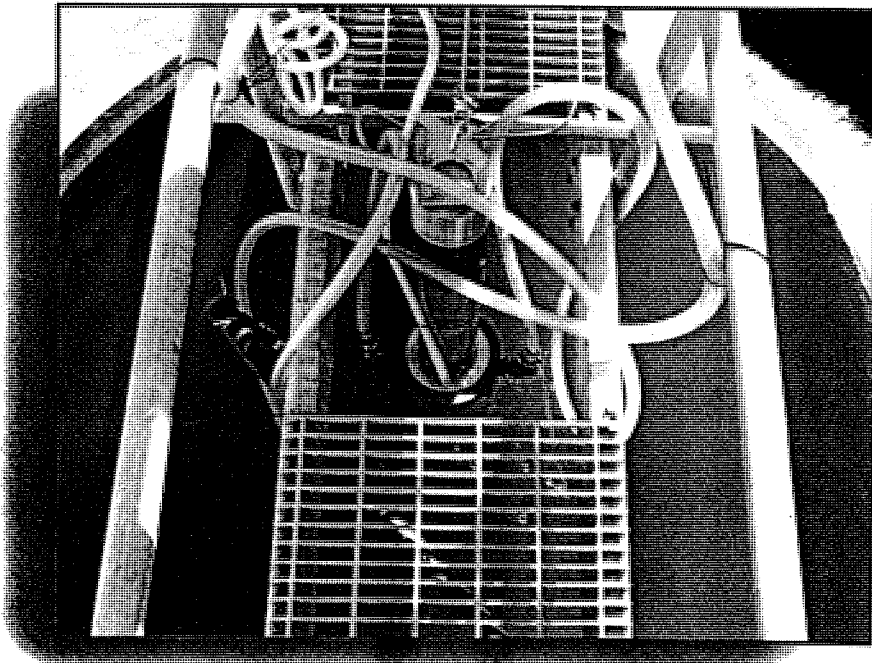

TIVAR* is a product of the MENASHA CORPORATION

STAINLESS STEEL SUBMERSIBLE

SERIES 32

The GAS MASTRRR series 32 submersible design allows the chemicals to be vacuum inducted and flash mixed directly into the water stream, channel, chamber, or rapid mix box with superior velocity gradient mixing intensity. The units easily install with new or retrofit with existing chemical feed equipment. Stainless steel guide rails and lifting (jib style) crane/hoists are available for easy retrieval of the unit for maintenance inspection.

The GAS MASTRRR series 32 utilizes a rugged and reliable U.S.A. manufactured submersible motor of 316 stainless steel construction for long-term duty in harsh submerged environments. The motors are liquid filled, water cooled, and are available for single and three phase service with a variety of VAC power voltage options.

The series 32 units are available in ranges from 1/2 - 20 Hp for feed rates up to 10,000 PPD gas and 150 GPM liquid chemical per unit. Optional "SAVVY" series combination starter and disconnect panels are available with voltage, amperage, and thermal monitoring for maximum protection of your chemical induction mixer investment. SUBTROL supplied standard on units 3 HP and above.

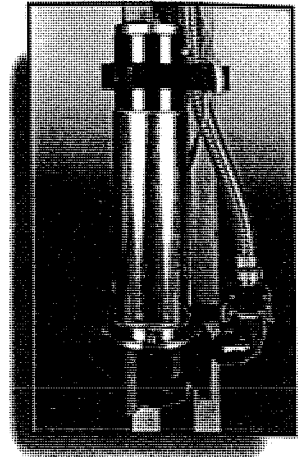

WASHDOWN DUTY FLANGED/INLINE

SERIES 32F

The GAS MASTRRR series 32F flanged units are ideally suited for applications in small pipelines (4" - 18") where low head loss and superior chemical mixing are important. The series 32F flanged design allows the chemical to be vacuum inducted and flash mixed directly into low pressure pipelines, tanks, or open vessels with superior velocity gradient mixing intensity. Pressured applications require chemicals in liquid form and metering pump equipment to overcome head pressure at the point of application.

The GAS MASTRRR series 32F units are available for 4", 6", and 8" ANSI flange services and have standard ranges from 1 - 20 HP for feed rates up to 10,000 PPD gas and 60 GPM liquid chemicals.

The series 32F utilizes a flanged U.S.A. manufactured TEFC washdown duty motor that meets demanding FDA requirements. The motors are epoxy coated and are available for single and three phase service with a variety of VAC power voltage options.

Optional "SAVVY" series panels, knife gate valves, and tapping sleeves are available.

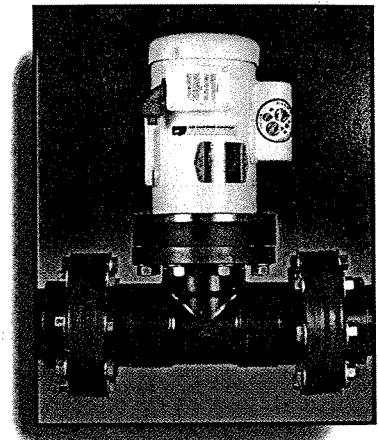

FLANGED "INLINE INSERTION"

SERIES 35F INTRUDRRR

The INTRUDRRR series 35F flanged design allows gas and or liquid chemicals to be vacuum inducted and flash mixed directly into low pressure large diameter pipelines with superior velocity gradient mixing intensity. Pressured applications require chemicals in liquid form and metering pump equipment to overcome head pressure at the point of application. The series 35F is supplied with a jacking stud removal system and isolating knife gate valve for unit retrieval when pipeline shutdown is not possible.

The INTRUDRRR series 35F units are available for 6", and 8" ANSI flange services and have standard ranges from 2 - 20 HP for feed rates up to 10,000 PPD gas and 75 GPM liquid chemical from a single unit.

The series 35F utilizes a close coupled U.S.A. manufactured TEFC washdown duty motor for long-term service in harsh outdoor environments. The motors are epoxy coated and are available for single and three phase service with a variety of VAC power voltage options.

Optional "SAVVY" series combination starter and disconnect panels, stainless steel knife gate valves, and tapping sleeves are available. The unit is supplied with a single vacuum feed port, a second feed port is available for multiple chemical flash mixing of gasses and liquids. Applications include water treatment facilities where large pipe static mixers are costly, high mixing intensity is required, low head loss and or space requirements are important.

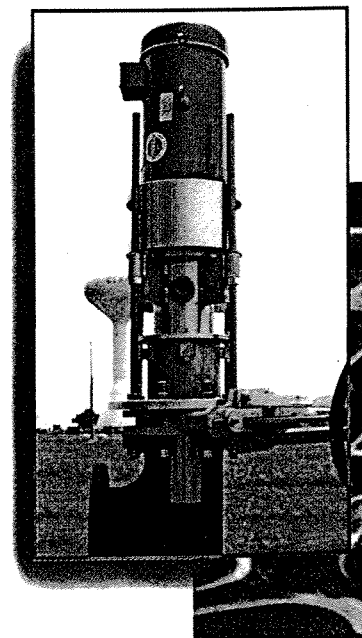

ACCESSORIES

STAINLESS STEEL GUIDE RAILS

Optional stainless steel guide rails are available for the series 32 and 36 submersible units, allowing easy retrieval for periodic inspection and maintenance. Stand off kits for "in the field" assembly are available to reduce freight costs and allow custom length rails to be easily assembled in the flow stream. Motor mounting brackets are available for horizontal, vertical, 45 degree, and pivoting (vertical to horizontal).

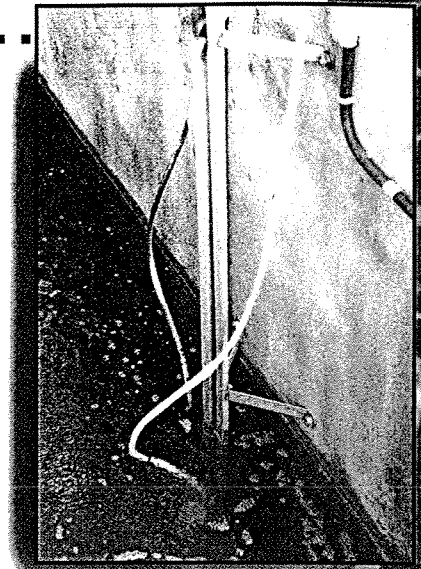

LIFTING STANCHION WITH HOIST

Stainless steel lifting stanchions (jib style) are available with flanged or socket base mounting. These industrial grade lifting stanchions include hand winch, stainless steel cable and lifting eye components. Hand winch options include three lifting capacity ranges and automatic or self braking features.

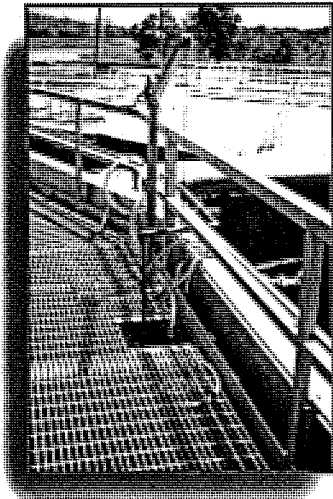

PVC FLEX HOSE & FITTINGS

Flexible PVC spring wire reinforced hose with quick disconnect cam & groove fittings are available in 3/4" - 2" diameter sizes. The PVC "Polywire" hose is anti-kinking, full vacuum rated, ozone and chemical resistant. This PVC flex hose option allows for quick and easy inspection of the series 32 without the hassle of ridged PVC pipe. All reducers, pipe nipples, fittings, true-union ball check valves are schedule 80 PVC with Teflon O-Rings.

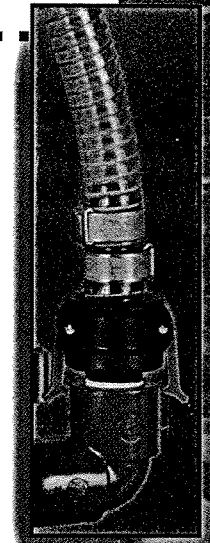

"SAVVY" CONTROL PANELS

The "SAVVY" series of pump motor status monitoring & control panels are designed for use with both submersible and flanged GAS MASTRRR induction units. Control panels are available for single or three phase service and a wide range of VAC supply voltages.

Custom options allow for panels to be supplied with a wide variety of monitoring parameters as well as combination starter and disconnect switches. Microprocessor based components allow accurate monitoring, alarm, fault indication, and control of both supply voltage and motor amperage as well as phase failure and unbalance.

Standard "SAVVY" features include a mechanical run time meter (ETM), pump status lamps, start/stop control switch, extra terminal blocks for remote control or indication and Nema class wiring. All "SAVVY" controllers are housed in Nema 4X enclosures and are available in stainless steel or nonmetallic corrosion resistant polyester.

All "SAVVY" control panels are sized, wired and tested to the HP unit specified.

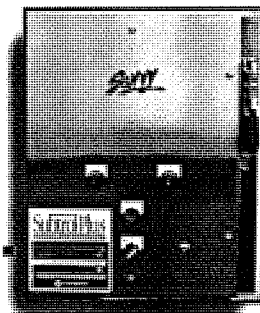

"SAVVY III" PANEL

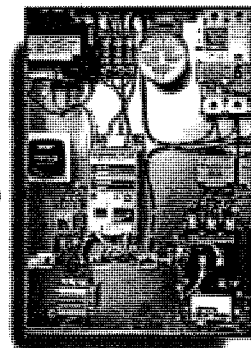

*THREE PHASE MONITOR



GATE VALVES

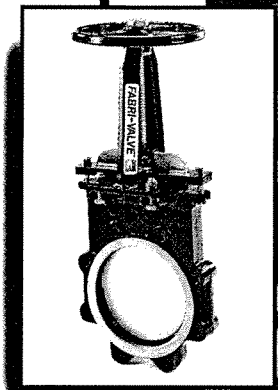

TIVAR*

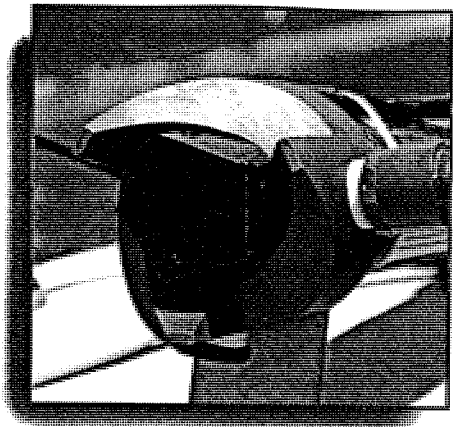

TIVAR* MEANS ABRASION RESISTANCE

The GAS MASTRRR units utilize an innovative non-fouling vacuum cavity distributor constructed of a UHMW Polyethylene material called TIVAR*. This material meets and exceeds the challenge of harsh water and wastewater environments. When rotating continuously at 3450 RPM in an environment full of sand and solids, impact and abrasive resistant materials are essential. TIVAR* reduces the component wear because of its unique molecular structure making it inherently superior at withstanding abrasive action. Various tests performed on TIVAR* to stimulate actual abrasion show it to surpass up to six times the abrasion resistance of the most common metals used in propeller design.

GAS MASTRRR sets a higher standard over conventional metal rotating propeller components with the use of TIVAR*. This space age polymer offers a unique combination of high impact strength, abrasion and chemical corrosion resistance. TIVAR* has excellent chemical resistance to both liquid and gas chemicals and exhibits zero water absorption. TIVAR* meets demanding FDA guidelines for pharmaceutical and food processing applications.

One of these test is the Sand Slurry Abrasion Test. In this test each material is weighed, rotated at 1750 RPM in a 50/50 sand/water slurry mixture for seven hours and weighed again. Carbon Steel is rated at 100. The number for each material depicts the relative weight loss due to abrasion, the lower the figure, the better the abrasion resistance.

All tests were performed by The Menasha Corporation makers of TIVAR*.

Sand Slurry Abrasion Test Results

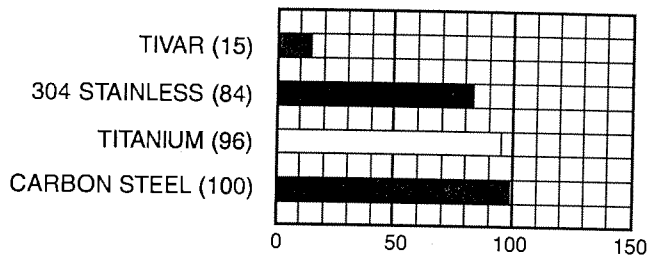

The lower the figure, the better the abrasion resistance

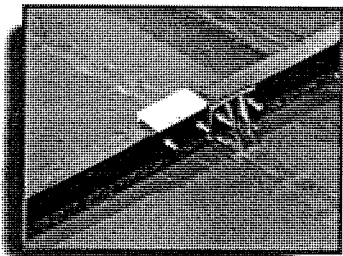

TIVAR* strips protect against excessive wear in wastewater applications and exhibit zero water absorption.

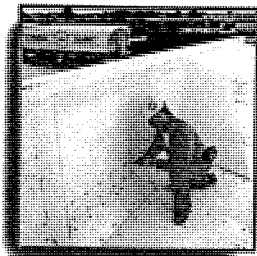

TIVAR* plates protect the steel walls and beds of dump trucks and rail cars from sand or gravel abrasion.

U.S.A. MANUFACTURED MOTORS

The GAS MASTRRR series of submersible and flanged vacuum induction chemical flash mixers utilize the highest quality U.S.A. manufactured motors.

The series 32F, 33, and 35F flanged inline units are supplied standard with BALDOR washdown duty TEFC motors. These motors are UL recognized, CSA certified, and FDA approved for pharmaceutical and food processing applications. For water and wastewater applications the durable two part external epoxy finish make these motors ideal for harsh outdoor exposed environments. All washdown duty motors have premium double-sealed ball bearings, lubricated with moisture resistant grease for longer life. The units are available for three phase service with a variety of VAC voltage options.

The series 32 and 36 submersible units are supplied with stainless steel FRANKLIN ELECTRIC submersible motors. These motors are ideally suited for submerged duty in water and wastewater applications where a corrosion and chemical resistant stainless steel motor is required. They are water cooled and mineral oil filled for internal lubrication of the rotary face seals, bearings and self aligning Kingsbury-type thrust bearing. FRANKLIN ELECTRIC motors are UL recognized and CSA certified.

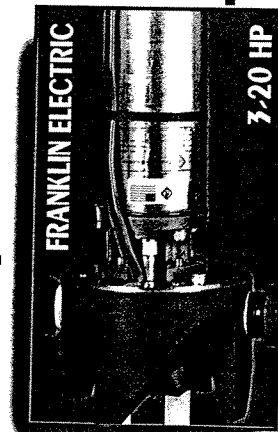
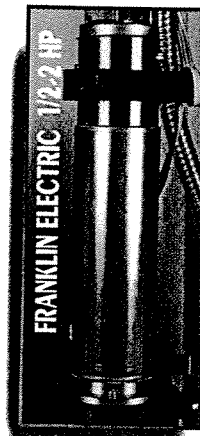
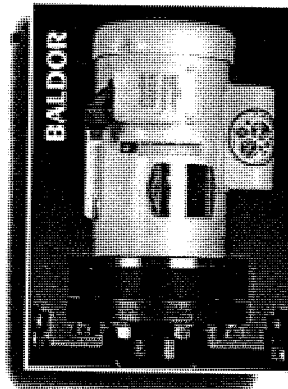

INSTALLATION

The GAS MASTRRR series of chemical vacuum induction flash mixers easily install with new and or retrofit to existing chemical feed equipment systems. The units eliminate the need for an ejector, water supply, booster pump, diffuser, and mechanical mixer. The GAS MASTRRR unit creates a strong vacuum which safely pulls the chemical from the source to the point of application and flash mixes it directly into the process stream with superior velocity gradient mixing intensity.

The GAS MASTRRR series of induction units are available in a submersible and flanged inline style. The series 32 and 36 submersible units are designed for chemical and air induction into open channel streams, basins, and vessels. The flanged style 32F, 33 and 35F are designed for liquid and or gas chemical flash mixing in tanks, vessels, and pipeline applications.

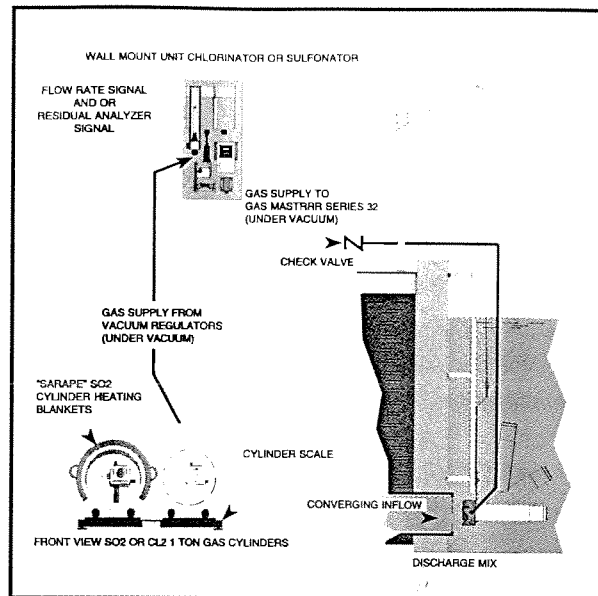

PARTIAL CHEMICAL LIST

AIR, CHLORINE, SULFUR DIOXIDE, CARBON DIOXIDE, OZONE, ANHYDROUS AMMONIA, SODIUM HYPOCHLORITE, POLYMER, ALUM, HYDROGEN PEROXIDE, POTASSIUM PERMANGANATE, SODIUM BISULFITE, AND MANY OTHER LIQUID AND GAS CHEMICALS.

WARRANTY & EXCHANGE PROGRAM

The GAS MASTRRR series of induction flash mixers carry a limited warranty for a period of one year from date of shipment to the buyer. The units are backed with a *factory exchange program* that eliminates the need for stocking spare parts or time consuming pump repair. At any time during the life of the unit should any problem occur, the unit may be exchanged for a like new unit (of same HP or feed range) with a new one year limited warranty for a set exchange rate (published yearly). Simply ship in the old unit, no matter what the condition, and we will exchange it. This *factory exchange program* is also available for competitive induction units. Ship us your Water Champ or CHLOR-A-VAC unit in any condition, and we will exchange it with a GAS MASTRRR unit of same HP or feed range for a set exchange rate. Call us TOLL FREE (800)299-6836 for more details or for an exchange quote on your non-functioning Water Champ or CHLOR-A-VAC units.

WE EXCHANGE WATER CHAMP / CHLOR-A-VAC IN ANY CONDITION

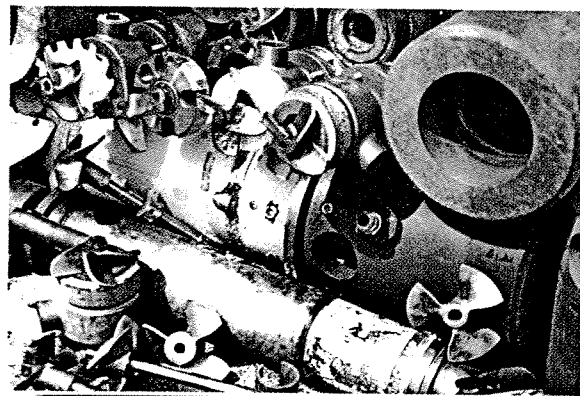

The Mastrrr Company
 Manufacturers of Vacuum Induction Chemical Feeder Mixers

Toll Free U.S.A. 1(800) 299-6836 or (281) 461-8999
 Toll Free U.S.A. Fax 1(800) 226-2659 or (281) 461-8900
 E-MAIL mastrrr@c-com.net
 P.O. Box 12902 Houston, Texas 77217

Represented By:



THE MASTRRR COMPANY
 PRODUCTS ARE PROUDLY MADE IN THE U.S.A.

APPENDIX B

ALDEN RESEARCH LABORATORY, INC.
QUALITY ASSURANCE PROGRAM

August 14, 2000

ALDEN RESEARCH LABORATORY, INC.
QUALITY ASSURANCE PROGRAM

1.0 Organization and Personnel

1.1 Alden General Organization

The Alden President has ultimate responsibility for the technical, fiscal, and contractual aspects of all studies conducted at Alden. Responsibility for technical aspects of a study is delegated to a Vice President or a senior level engineer, who will serve as the Principal Investigator of the study.

The various support services report to a combination of the President and various Vice Presidents.

1.2 Project Organization and Personnel Responsibilities

The Principal Investigator is directly responsible to the Purchaser for conducting the study. The Principal Investigator is responsible for activities such as planning, designing, testing, and reporting for the project. Other engineers and technical assistants, if assigned to the study, report directly to the Principal Investigator.

The Quality Assurance Program will be implemented by the Principal Investigator through the supervisory chain. The Principal Investigator shall have the responsibility of issuing a written stop work order whenever any work in progress is not in accordance with the project specification or the Alden Quality Assurance Program.

The Principal Investigator shall have the responsibility of training all personnel assigned to the project with respect to implementation of the Alden Quality Assurance Program.

Services required for proper and timely execution of the study, such as instrumentation, crafts, and graphic arts, are requested directly by the Principal Investigator from the desired services unit. The Vice President supervising that service becomes involved if conflicts in priorities arise.

2.0 Records and Documents

2.1 Routing and Recording Incoming and Outgoing Correspondence

All incoming correspondence for the study will be received by or routed to the Alden Main Office. At the Main Office, the original will be stamped "file copy," copied, and the original filed in the Central File. The Principal Investigator and President will be provided copies. At the discretion of the Principal Investigator, additional copies will be provided to other key personnel. Action items will be marked as such and the action assigned.

All outgoing correspondence will be mailed by the Alden Main Office. Copies will be maintained in the Central File and copies provided to the originator, Principal Investigator, and President.

Telephone conversations related to the project will be documented with notes.

2.2 File System

A Central File will be maintained in the Alden Main Office under client name and job code. All originals of incoming correspondence and copies of all outgoing correspondence will be kept in this file, with the possible exception of drawings, see Section 2.3. Copies of appropriate project drawings, calculations, computer disks and data will be entered in the Central File upon completion of the study.

The Main Office head secretary will have responsibility for maintenance of the Central File system.

2.2.1 Distribution

Copies of the Quality Assurance Manual will be maintained at the following locations:

1. One copy in the Central File,
2. One copy in the Principal Investigator's office,
3. One copy at the Alden job site,
4. One copy is sent to the Purchaser (additional copies may be issued to the Purchaser upon request).

All copies will receive any revisions made to the QA Manual.

2.3 Drawings

Drawings received by Alden from the Purchaser will be transmitted to the Principal Investigator. If two copies of drawings are received, one copy will be maintained in the Central File.

A copy of relevant internally generated drawings will be filed in the Project Notebook or in the Central File, all such drawings eventually being retained in the Alden storage area.

Project drawings will be numbered, and a log of project drawing numbers will be maintained by the Principal Investigator or his authorized agent. Revisions will be recorded on the log of project drawings.

2.4 Study Documents

2.4.1 Log Book

The Project Log Book will be kept at the experimental facility while conducting experimental studies. The Project Log Book will contain a daily record of all activities during the test program. Data recorded on data sheets, computer printouts, etc., shall be assigned a sequential test number and a document number, which will be referenced in the daily log. It is not necessary that all data and pertinent drawings be bound in the Project Log Book, but they must be referenced in the log and maintained as part of the project documentation.

2.4.2 Computer Disks

Removable computer disks that are used to store study results will be identified by project name, the Alden project code, the test number, and a document number. An entry identifying the disk will be made in the test log. Such disks will be stored as part of the project file in the Central File at the end of the study.

2.5 File Retention

Upon completion of the project, all pertinent data and drawings generated by the project, including hard copies of computer data and portable disks, will be placed in a common storage box(es). The storage box will be placed in a designated Alden storage area for retention. The Central File maintained in the Main Office will be retained at that location for a period of one year after project completion. Subsequently, the Central File will also be placed in the common storage box for the study.

2.6 Revisions

If a design calculation or drawing requires revision, a new document will be originated under the requirements of Section 3.0. In addition, the new document shall include the phrase "revision of document" and the superseded document number. The original document shall have the phrase "revised" and the superseding document number added with the initials of the Principal Investigator and the date.

Revisions of a test procedure or calibration procedures will include a revision number. The Principal Investigator will have the responsibility to transmit the requisite procedures to the test operator. When a procedure revision is implemented, the revision number and implementation date will be recorded in the test log.

3.0 Design

3.1 Applicable Standards, Criteria, Specifications

Any design memorandum issued by the Principal Investigator will list applicable published and generally available standards, codes, criteria, and specifications. The design memorandum will indicate where copies of such applicable criteria are filed, which sections are to be applied to the design, and which criteria apply to specific design phases and facility components.

If any changes or deviations from applicable standards are made during the facility design, these shall be documented by a memo of change, to be approved by the Principal Investigator.

3.2 Design Process

Standard Alden calculation sheets will be used to perform manual calculations. Sources of input data, factors, equations, etc., will be identified and referenced to provide traceability. Assumptions will be identified. The object of the calculations will be stated, and the conclusions highlighted or set aside. All design drawings, calculations, graphs, and other design documents will be identified by appropriate project and subject titles, and be dated, initialed, and numbered by the originator.

3.3 Review Requirements

At the completion of the design of each component of the project, the Principal Investigator or his authorized agent will review and initial critical drawings and calculations for the component reviewed.

An authorized reviewer will be in the position of Engineer or higher. In no case will review by the originator be considered acceptable. (This does not preclude review by the originator prior to second party review.) If the reviewer notes any error, these will be discussed with the preparer, and if changes or corrections are agreed to by both parties, those changes or corrections will be made in another color by the reviewer. Completion of the review will be indicated on each reviewed document by the initials of the reviewer and the date reviewed.

4.0 Construction

4.1 Review of Test Equipment and Components

Components will be inspected and checked for accuracy after completion. The test facility will be inspected immediately upon completion to ensure conformance to design. The reviewer will be the Principal Investigator or his authorized agent.

4.2 Review Requirements

The component and test facility reviews will verify conformance to design. The value of measured dimensions will be recorded on a copy of the appropriate design drawing by the reviewer. The drawing copy will be dated and initialed by the reviewer. In the case of discrepancies beyond mutually agreed upon tolerances, the appropriate changes will be made, and the drawing copy will be marked to reflect as-built conditions.

4.3 Review Report

The reviewer will make an entry in the project log book to reflect review findings. The work order will be initialed and dated by the reviewer to indicate that the component or installation is complete and in accordance with the design.

The reviewed and initialed design drawing copies marked with as-built dimensions (if different than those shown) will be retained in the Project Notebook.

5.0 Instrumentation/Equipment

5.1 Calibration Procedure Requirements

- Each instrument in the calibration program will bear a unique number, date of last calibration, and initials of person performing calibration.
- All resulting calibration sheets and plots will be dated and numbered. Each data calculation involving an instrument calibration shall reference the appropriate numbered calibration form.

5.2 Equipment/Material Purchases

If Alden purchases any equipment or non-expendable materials from outside sources (vendors) for use in the model study, the vendor QA Program will be revised to involve appropriate QA requirements on their suppliers. No QA program will be necessary for expendable materials.

5.3 Computer Software

If any software programs other than commercially available programs (e.g., Quattro Pro, Lotus) are used in conjunction with the model study, Alden's QA program will be revised to add provisions for verification and validation of the software. Use of computer software, other than spreadsheets, is generally not anticipated.

6.0 Operation and Testing (including computer analysis)

6.1 Test Plan Report

Prior to commencement of the test program, a Test Plan Report will be written, which will, as a minimum, include:

- A statement of the test purpose
- A description of all variables which are to be controlled
- A description of the physical parameters to be measured
- A description of the necessary instrumentation
- A description of the operational sequence of events required
- A description of the procedures for data retrieval

Model parameters relevant to a specific test, such as water level, flow rates, and special model geometry, will be defined by the Principal Investigator or his authorized agent and transmitted to the model operator. A unique test number will be assigned, and the test order will become a permanent part of the test log.

The Test Plan Report will be reviewed and approved by the client. Copies of the Test Plan Report will be available at the experimental facility.

6.2 Data Retrieval Procedures

Standard Alden sheets and log books will be used to record data. All data will be recorded in a clear, legible manner and properly formatted, as appropriate. The data set for each test will be identified by, as a minimum, the following general information:

- Job name and number
- Sponsor
- Test number
- Title of test
- List of instruments used (serial numbers)
- Special test procedures

- Data recorder initials
- Data reviewer initials
- Date

6.3 Data Reduction and Analysis

Standard Alden calculation sheets will be used to perform data analysis. Sources of input data, calibration factors, equations, etc., will be identified and referenced to provide traceability. Assumptions will be identified. The preparer will initial, number, and date all pages, and identify each document by appropriate project and subject titles. If computer analysis is used, then a copy of the printout will be attached to the calculation sheet. This copy will be clearly marked to identify the program and filename used.

In cases where a number of minor calculations are required, several may be done on one sheet provided they are clearly identifiable.

6.4 Reporting of Data

Normal Alden procedures will be used in preparing reports. Tables, figures, and graphs will be checked for accuracy by the Principal Investigator or his authorized agent.

All reports will be reviewed by the Principal Investigator in draft form prior to being submitted to the Purchaser for review. Review completion will be noted by initials of the reviewer and date on the draft copy filed in the Central File. Comments will be evaluated and incorporated when appropriate. Final reviews will be conducted prior to and after printing.

6.5 Test Review Procedures

Audits, accomplished by the Principal Investigator, will verify the test parameter setup, and these audits will be recorded, including signature and date. Non-conformance and required remedial action will be noted.

As soon as possible after a data sheet has been completed, it will be reviewed. The review, conducted to check accuracy and completeness, will be indicated by the signature of the reviewer and the review date.

Data analysis calculations will be reviewed in a similar manner. The review will take place as soon as possible after calculation completion and before any use is made of the calculation conclusions for further study or reporting.