

US EPA ARCHIVE DOCUMENT

**Environmental Technology
Verification Program**
Advanced Monitoring
Systems Center

Test/QA Plan for Long-Term
Deployment of Multi-Parameter
Water Quality Probes/Sondes

TEST/QA PLAN

FOR

**LONG-TERM DEPLOYMENT OF
MULTI-PARAMETER WATER QUALITY PROBES/SONDES**

May 13, 2002

Prepared by

**Battelle
505 King Avenue
Columbus, OH 43201-2693**

Approval of ETV Advanced Monitoring Systems Center

“Test/QA Plan for Long-Term Deployment of
Multi-Parameter Water Quality Probes/Sondes”

Version 1.0

May 13, 2002

Name _____

Company _____

Date _____

DISTRIBUTION LIST

Ms. Elizabeth A. Betz
U.S. Environmental Protection Agency
National Exposure Research Laboratory
MD-44
Research Triangle Park, NC 27711

Mr. Robert Fuerst
U.S. Environmental Protection Agency
National Exposure Research Laboratory
MD-46
Research Triangle Park, NC 27711

Ms. Elizabeth Hunike
Quality Assurance Specialist
U.S. Environmental Protection Agency
National Exposure Research Laboratory
ERC Annex, MD-46
Research Triangle Park, NC 27711

Dr. Geoffrey Scott
Chief, Marine Ecotoxicology Branch
NOAA/NOS Center for Coastal Environmental
Health & Biomolecular Research
219 Ft. Johnson Road
Charleston, SC 29412

Dr. Paul Pennington
Research Specialist II
NOAA/NOS Center for Coastal Environmental
Health & Biomolecular Research
219 Ft. Johnson Road
Charleston, SC 29412

Dr. Alan Lewitus
South Carolina Department of Natural Resources-MRRI
217 Fort Johnston Road
Charleston, SC 29422

Mr. Ron Chandler
YSI, Inc.
1700/1735 Brannum Lane
P.O. Box 279
Yellow Springs, OH 45387

Terry Dickey
Hydrolab Corporation
8700 Cameron Road
Suite 100
Austin, Texas 78754-3908

Mr. Regis Cook
General Oceanics
1925 N.W. 163 Street
Miami, FL 33169

Ms. Pam Millet
Horiba Sales Engineer
17671 Armstrong Avenue
Irvine, CA 92614

Mr. Jeffrey D. Myers
Battelle
505 King Avenue
Columbus, OH 43201

Ms. Karen Riggs
Battelle
505 King Avenue
Columbus, OH 43201

Dr. Thomas Kelly
Battelle
505 King Avenue
Columbus, OH 43201

Mr. Charles Lawrie
Battelle
505 King Avenue
Columbus, OH 43201

Mr. Zachary Willenberg
Battelle
505 King Avenue
Columbus, OH 43201

TABLE OF CONTENTS

1.	Introduction	1
1.1	ETV Background	1
1.2	Test Objective	1
1.3	Test Applicability	2
2.	Technology Description	3
3.	Verification Approach	3
3.1	Scope of Testing	3
3.2	Experimental Design	4
3.3	Reference Testing	6
3.4	Test Location	6
3.5	Roles and Responsibilities	7
3.5.1	Battelle	7
3.5.2	Vendors	11
3.5.3	EPA	11
3.5.4	Test Facility	12
4.	Test Procedures	13
4.1	Site Selection	13
4.2	Multi-Parameter Water Probe Deployment	15
4.3	Mesocosm Testing	15
4.4	Saltwater Testing	17
4.5	Freshwater Testing	18
4.6	Multi-Parameter Water Probe Calibration	21
4.7	Reference Methods	21
4.7.1	pH	21
4.7.2	Turbidity	22
4.7.3	Dissolved Oxygen	22
4.7.4	Nitrate	22
4.7.5	Chlorophyll A	22
4.7.6	Conductivity	22
4.7.7	Temperature	23
5.	Material and Equipment	23
5.1	Reagents	23
5.2	Sampling Equipment and Handling	23
5.3	Reference Equipment	24

6.	Quality Assurance/Quality Control	24
6.1	Calibration	24
6.2	Field Quality Control	25
6.3	Sample Custody	26
6.4	Audits	26
	6.4.1 Performance Evaluation Audits	26
	6.4.2 Technical Systems Audit	29
	6.4.3 Data Quality Audits	29
	6.4.4 Assessment Reports	30
6.5	Corrective Action	30
7.	Data Handling and Reporting	30
7.1	Documentation and Records	30
7.2	Data Review	31
7.3	Statistical Procedures	33
	7.3.1 Pre- and Postcalibration Results	33
	7.3.2 Relative Bias	33
	7.3.3 Precision	34
	7.3.4 Linearity	35
	7.3.5 Inter-Unit Reproducibility	35
7.4	Reporting	35
8.	Health and Safety	36
9.	References	36

Appendices

Appendix A	SOPs and EPA Test Methods	A-1
Appendix B	Data Sheet/Chain of Custody	B-1

List of Figures

Figure 1. Mesocosm Tank 5

Figure 2. Organization Chart for Multi-Parameter Water Probe
Verification 8

Figure 3. Major Bodies of Water Leading into the Testing Area 14

List of Tables

Table 1. Schedule for the Multi-Parameter Water Probe Test 6

Table 2. Expected Ranges of Water Characteristics at the Planned Test Sites 14

Table 3. Schedule for Mesocosm Sample Collection 16

Table 4. Sample Analysis Location 17

Table 5. Schedule of Reference Method Sample Events on Each Day of Testing
at the Charleston Harbor Site 19

Table 6. Schedule of Reference Method Sample Events on Each Day of Testing
at the Lake Edmunds Site 20

Table 7. Maximum Holding Time 24

Table 8. Replicate Analysis Results 25

Table 9. Expected Values for Field Blanks 26

Table 10. Summary of Performance Evaluation Audits 27

Table 11. Summary of Data Recording Process 32

ACRONYMS

AMS	Advanced Monitoring Systems
CCEHBR	Center for Coastal Environmental Health and Biomolecular Research
DO	dissolved oxygen
EPA	United States Environmental Protection Agency
ETV	Environmental Technology Verification
NIST	National Institute of Standards and Technology
NOAA	National Oceanic and Atmospheric Administration
QA	quality assurance
QMP	Quality Management Plan
SOP	standard operating procedure
TSA	technical systems audit

1. INTRODUCTION

1.1 ETV Background

This test/quality assurance (QA) plan provides detailed procedures for a verification test of multi-parameter water quality probes/sondes that continuously measure water quality parameters. The verification test will be conducted under the auspices of the U.S. Environmental Protection Agency (EPA) through its Environmental Technology Verification (ETV) program. The purpose of the ETV program is to provide objective and quality-assured performance data on environmental technologies, so that users, developers, regulators, and consultants can make informed purchase and application decisions about these technologies. ETV verification does not imply approval, certification, or designation by EPA, but rather provides a quantitative assessment of the performance of a technology under specified test conditions.

The verification test will be coordinated by Battelle, of Columbus, Ohio, which is EPA's partner in the ETV Advanced Monitoring Systems (AMS) Center. The scope of the AMS Center covers verification of monitoring technologies for contaminants and natural species in air, water, and soil. In performing the verification test, Battelle will follow the procedures specified in this test/QA plan and will comply with the data quality requirements in the "Quality Management Plan for the ETV Advanced Monitoring Systems Center" (QMP).¹

1.2 Test Objective

The purpose of verification tests generated from this test/QA plan is to evaluate the performance of multi-parameter water probes under realistic operating conditions. Specifically, these probes will be deployed in a location or locations similar to those that would be used by members of the water monitoring community, and the probes' performance will be evaluated by

comparing pre- and postcalibration results and their measurements with standard reference measurements. This test/QA plan calls for probes to be deployed in laboratory, freshwater, and saltwater environments near Charleston, South Carolina, for a 2 ½-month field test in which the probes will be operated continuously for periods up to 30 days. (Different locations and test periods may be accommodated with this plan, if appropriate for the water probes being tested.) During this time, water quality parameters such as turbidity, chlorophyll A, nitrate, conductivity, temperature, dissolved oxygen (DO), and pH will be measured both by the monitors (when applicable) and by reference methods. In the laboratory environment, these parameters will be controlled, while in the freshwater and saltwater phases of the verification, these parameters will not be controlled. During each phase, assessments of performance will be based upon comparisons to the reference results, and include determinations of accuracy, precision, linearity, and inter-unit reproducibility.

1.3 Test Applicability

This test/QA plan is applicable to the verification testing of probes that operate unattended in lakes; rivers; coastal areas; estuaries; bays; and other fresh, salt, or brackish bodies of water and that continuously measure one or more water quality parameters, such as turbidity, chlorophyll A, nitrate, conductivity, temperature, DO, or pH. In accordance with the intent of the ETV program, the probes to be tested are commercially available and not developmental products or prototypes. No enhancements of a commercially available product can be used. This includes using any special anti-fouling coating or paints that are not part of the standard product.

2. TECHNOLOGY DESCRIPTION

The probes to be tested typically consist of a sensor or sensors in a rugged housing at the end of a tethered line. The probes are portable and usually must be tethered to a buoy, dock, piling, or similar structure. While some may be capable of wireless transmission of data, many probes require that stored data be physically downloaded by the user.

The multi-parameter water probes that may be verified under this testing protocol must be able to undergo the testing explained in Chapter 4. In general, probes must be able to measure two or more parameters listed in Section 1.3 of the test/QA plan, in both salt and freshwater. It must be deployable, in the sense that the probe must be able to make the water quality measurements without the assistance or intervention of an operator. A probe must be able to store the measured water quality values for a minimum of two weeks at an hourly sampling rate and must be able to sample at a depths between 1 and 15 feet.

3. VERIFICATION APPROACH

3.1 Scope of Testing

The objective of this test is to establish the performance capabilities of multi-parameter water probes under operating conditions that are realistic in terms of type of water body, depth, duration of unattended operation, etc., as well as in a laboratory or controlled setting. To achieve this goal, this verification test will involve three phases. In the first phase, the probes will be tested in a saltwater location. The second phase of verification will take place at a freshwater location. In each of these two phases, the probes will monitor the naturally occurring levels of each parameter. These longer phases, of 30 sampling days each, will be used to determine how well the monitors compare with the reference methods while being continuously deployed in a field setting. The third phase will be in a laboratory or controlled environment. During this

week-long phase, the probes will be tested over target parameter ranges that are partially controlled. The turbidity and conductivity will be adjusted while recording the response of the probes. In all tests, two units of each probe will be operated side by side to make inter-unit comparisons.

3.2 Experimental Design

The test is designed to assess the performance of multi-parameter water probes relative to reference methods that may consist of using either a grab sample and laboratory analysis or another real-time monitor. This test will be closely coordinated with the National Oceanic and Atmospheric Administration (NOAA) through the Center for Coastal Environmental Health and Biomolecular Research (CCEHBR). The test will be performed at or near CCEHBR facilities in Charleston, South Carolina. The approach to the verification test is summarized below, and the statistical methodology for establishing performance parameters is described in Section 7.3. This test will be in three phases, with each phase occurring in a different type of water body.

The first phase of the test will occur at a saltwater site at CCEHBR and will last approximately one month. The CCEHBR campus has direct access to Charleston Harbor, which is a tidally dominated body of water that receives some riverine input, with salinities ranging from 20 to 35 parts per thousand. The South Carolina Department of Natural Resources has several piers and docks that can be used to deploy the instruments. Also, other areas in close proximity can be used if the instruments need to be deployed away from dock and boat activity. Many types of land use in the area surrounding Charleston Harbor can affect overall water quality, including residential, industrial, urban, and dredge spoil.

The second phase of the test will occur at a freshwater site and last approximately one month. The site is a five-acre freshwater pond named Lake Edmunds approximately one mile from the CCEHBR facilities, located on the property of a NOAA staff member (Dr. Peter Key).

The third phase will take place over a one-week period at the CCEHBR's Mesocosm Facility. This facility contains modular estuarine mesocosms, consisting of a 300-liter tank containing elevated sediment trays and stream channels. Each sediment tray is arranged so that an elevated salt marsh surface is formed. The sediment trays contain sediment, salt marsh vegetation, and benthic communities. Stream channels contain phytoplankton, zooplankton, and endemic macrofaunal species. Another component of the mesocosm is a reservoir or sump that provides tidal water to the system through a pump system controlled by a timer. Twice daily, seawater is pumped up into the mesocosm tank from the sump to simulate a flood tide. After six hours of flooding tide, the seawater is allowed to drain back into the sump, simulating an ebb tide for another six hours. Mesocosms used for this test can be classified as "tidal" or "estuarine." Figure 1 shows a single mesocosm tank.

The proposed schedule for the various testing activities is given in Table 1. In each phase, individual vendor's probes will be positioned as near each other as possible. This will be done so that, for each vendor, inter-unit comparisons can be made. In addition, the probes from different vendors will be placed near each other so that parameters such as photosynthesis and mixing are as similar as possible.



Figure 1. Mesocosm Tank

Table 1. Schedule for the Multi-parameter Water Probe Test

Activity	Date
Vendor setup for saltwater site	June 10
Begin saltwater test	June 17
End saltwater test	July 18
Vendor setup for freshwater test	July 19
Begin freshwater test	July 29
End freshwater test	August 30
Vendor setup for mesocosm test	September 4
Begin mesocosm test	September 9
End mesocosm test	September 13
Vendor removal of equipment	September 16

3.3 Reference Testing

During this verification test, various analytical methods will be used to monitor turbidity, chlorophyll A, nitrate, conductivity, temperature, DO, and pH. Temperature, pH, DO, and conductivity will be monitored in real time with devices that are collocated with the probes being verified. Turbidity, chlorophyll A, and nitrate concentrations will be measured using laboratory analysis of collected samples. Turbidity will be measured using a Hach Ratio XR turbidity meter, chlorophyll A will be measured using a Turner 10-AU fluorometer, and nitrate will be measured colorimetrically using a Lachat Instruments QuikChem autoanalyzer.

3.4 Test Location

CCEHBR meets the requirements of a test facility for this verification. Specifically, a test facility must be capable of providing a secure and realistic location for deploying the multi-parameter water probes, must have standard operating procedures (SOPs) or written methods in place for the reference measurements, have trained personnel capable of performing these activities according to those SOPs and must have documented QA procedures in place.

Documentation of the staff training, SOPs, and other pertinent materials will be provided to Battelle prior to test initiation.

3.5 Roles and Responsibilities

The verification test will be coordinated and supervised by Battelle personnel. Staff from the CCEHBR test facility will participate in this test by operating the reference equipment, collecting the water samples, downloading the data from the multi-parameter water probes, and informing Battelle staff of any problems encountered. Vendor representatives will install, maintain, and operate their respective technologies throughout the test unless they give written consent for CCEHBR or Battelle staff to carry out these activities. QA oversight will be provided by the Battelle Quality Manager, and the EPA ETV Quality Manager at her discretion. The chart shown in Figure 2 shows the organization of responsibilities for Battelle, the vendor companies, EPA, and the test facility. The specific responsibilities of these individuals are detailed below.

3.5.1 Battelle

Mr. Jeffrey Myers, the Battelle Verification Test Coordinator will have the overall responsibility for ensuring that the technical, schedule, and cost goals established for the verification test are met. The Verification Test Coordinator will

- Prepare the draft test/QA plan, verification reports, and verification statements
- Revise the draft test/QA plan, verification reports, and verification statements in response to reviewers' comments
- Coordinate distribution of the final test/QA plan, verification reports, and verification statements
- Coordinate testing, measurement parameters, and schedules at the testing site

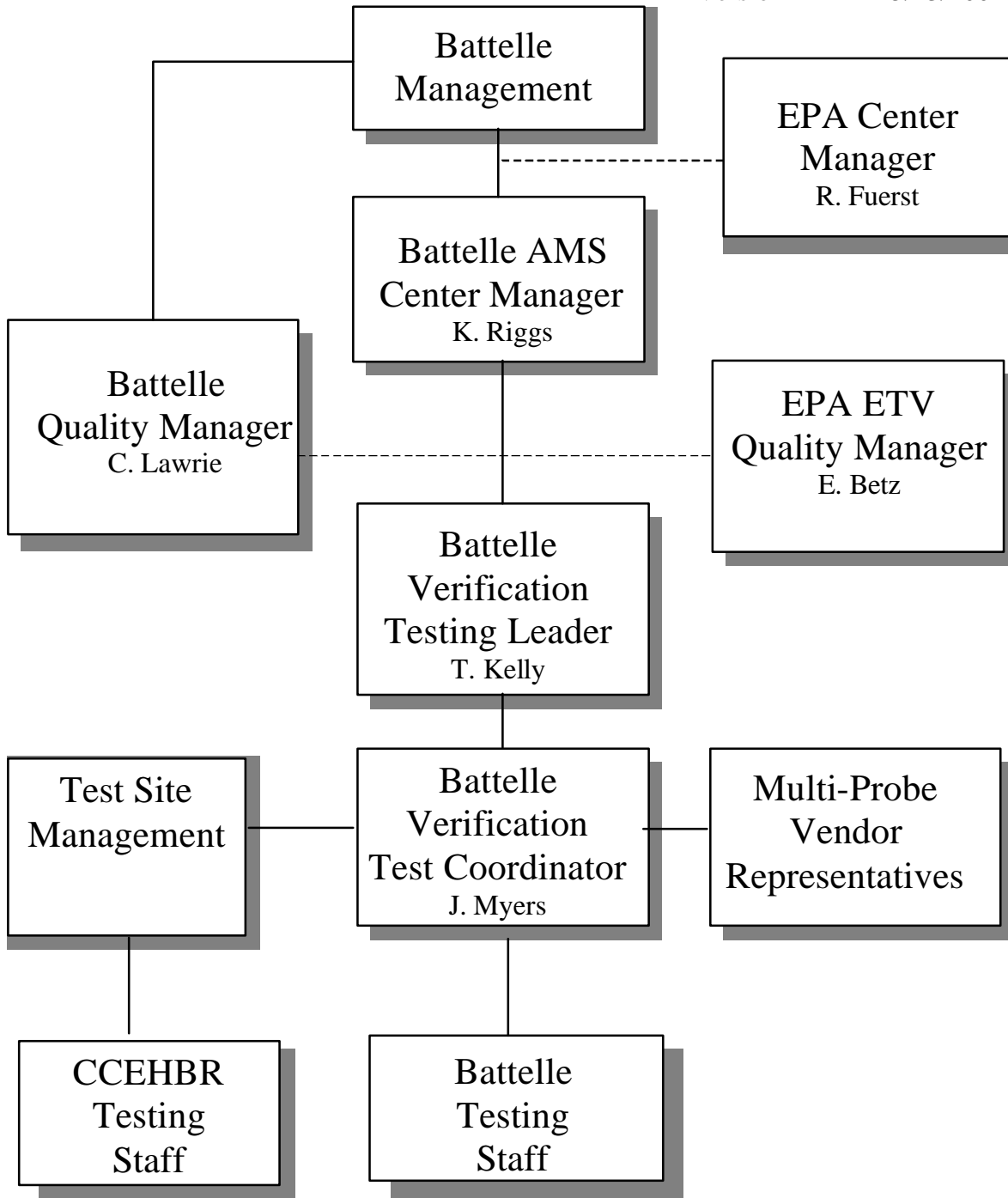

Figure 2. Organization Chart for Multi-Parameter Water Probe Verification

- Ensure that all quality procedures specified in the test/QA plan and in the QMP are followed
- Respond to any issues raised in assessment reports and audits, including instituting corrective action as necessary
- Serve as the primary point of contact for vendor and test facility representatives
- Establish a budget for the verification test and monitor staff effort to ensure that the budget is not exceeded
- Ensure that confidentiality of proprietary vendor technology and information is maintained
- Coordinate with sample analysis laboratory to ensure timely reporting of results.

Dr. Thomas J. Kelly, the Verification Testing Leader for the AMS Center will provide technical guidance, oversee various stages of the verification test, and

- Support the Verification Test Coordinator in preparing the test/QA plan and organizing the testing and budgeting for the verification activities
- Review the draft test/QA plan
- Review the draft verification reports and statements
- Ensure that confidentiality of proprietary vendor technology and information is maintained.

Battelle's AMS Center Manager, Ms. Karen Riggs, will

- Review the draft test/QA plan
- Review the draft verification reports and statements
- Ensure that necessary Battelle resources, including staff and facilities, are committed to the verification test

- Support the Verification Test Coordinator in responding to any issues raised in assessment reports and audits
- Maintain communication with EPA's AMS Center and Quality Managers.
- Ensure that confidentiality of proprietary vendor technology and information is maintained.

Battelle's Quality Manager for this verification test, Mr. Charles Lawrie, will

- Review the draft test/QA plan
- Conduct a technical systems audit (TSA) once during the verification test
- Audit at least 10% of the verification data
- Prepare and distribute an assessment report for each audit
- Verify implementation of any necessary corrective action
- Issue a stop work order if self-audits indicate that data quality is being compromised or if proper safety practices are not followed; notify the Battelle AMS Center Manager if a stop work order is issued.
- Provide a summary of the audit activities and results for the verification reports
- Review the draft verification reports and statements
- Have overall responsibility for ensuring that the test/QA plan and ETV QMP are followed
- Ensure that Battelle management is informed if persistent quality problems are not corrected
- Interface with EPA's ETV Quality Manager.
- Ensure that confidentiality of proprietary vendor technology and information is maintained.

3.5.2 Vendors

Vendors will

- Review the draft test/QA plan and provide comments and recommendations
- Approve the revised test/QA plan
- Work with Battelle to commit to a specific schedule for the verification test
- Provide duplicate commercial-ready monitors for testing
- Provide an on-site operator(s) throughout the verification test period to install the monitors and maintain them during testing, unless written consent is given for Battelle or CCEHBR staff to perform those responsibilities.
- Remove monitors and other related equipment from the test facility upon completing the verification test
- Review and comment upon their respective draft verification reports and statements.

3.5.3 EPA

EPA's responsibilities in the AMS Center are based on the requirements stated in the QAMP for the AMS Center.⁽²⁾ The roles of the specific EPA staff are as follows:

EPA's ETV Quality Manager, Ms. Elizabeth Betz, will

- Review the draft test/QA plan
- Perform, at her option, one external TSA during the verification test
- Notify the Battelle AMS Center Manager to facilitate a stop work order if an external audit indicates that data quality is being compromised

- Prepare and distribute an assessment report summarizing results of the external audit, if performed
- Review draft verification reports and statements.
- Ensure that confidentiality of proprietary vendor technology and information is maintained.

EPA's AMS Center Manager, Mr. Robert Fuerst, will

- Review the draft test/QA plan
- Approve the final test/QA plan
- Ensure that confidentiality of proprietary vendor technology and information is maintained
- Approve the final verification reports
- Review the draft verification statements.
- Ensure that confidentiality of proprietary vendor technology and information is maintained.

3.5.4 Test Facility

Dr. Paul Pennington, Research Specialist at the CCEHBR test facility, will

- Assist in developing the test/QA plan for the verification test
- Allow access to the facility to vendor, Battelle, and EPA representatives during the field test periods
- Provide necessary safety instructions to Battelle, EPA, and vendor personnel for operations at the test facility
- Select a secure location for each of the three testing phases
- Assist vendors in installing the probes at each location

- Perform sample collections and analyses as detailed in the test procedures section of the test/QA plan
- Perform reference measurements
- Provide all test data to Battelle electronically, in mutually agreed upon format
- Provide EPA and Battelle staff access to and /or copies of appropriate QA documentation of test equipment and procedures (e.g., SOPs, calibration data)
- Provide information regarding education and experience of each researcher involved in the verification
- Assist in Battelle's reporting of the test facility's QA/quality control results
- Review portions of the draft verification reports to assure accurate descriptions of the test facility operations and to provide technical insight on verification results.

4. TEST PROCEDURES

4.1 Site Selection

Below are the general procedures to be followed at each of the test sites. Three test sites will be used for this verification in an attempt to expose the probes to as wide a range of conditions as possible while conducting an efficient test. The site selection process requires that several important criteria be met. First, the three sites must include one controlled, one saltwater (or brackish), and one freshwater location. The sites must allow for collocation of numerous probes because each vendor will provide duplicate probes for the test. The sites must be accessible daily so that timely water collections can be made; and the site must, to the extent possible, be free from interference from the public. A secure facility is not required, but is preferred. For this verification, the three locations chosen are the mesocosm site at the CCEHBR facility in Charleston, the Charleston Harbor, and Lake Edmunds. Figure 3 shows a map of South Carolina and a close-up map showing the testing sites. The CCEHBR was selected with the understanding that its facilities are under federal jurisdiction and, therefore, staff

involved in the test may be subject to safety/security constraints that have not been identified in this test/QA plan.

The sites at or near the CCEHBR facility were selected for several reasons. First it was beneficial to involve a major user (NOAA) of the multi-parameter water probes in the test to allow a broader verification test than would be possible using only Battelle facilities. Second, CCEHBR has secure, nearby sites available for all three phases of the test (mesocosm, freshwater, and saltwater), which allows resources to be devoted to testing rather than to building infrastructure for the test. Finally, these sites offer a useful variation of water conditions for testing. Typical ranges for the target parameters to be monitored are given in Table 2.

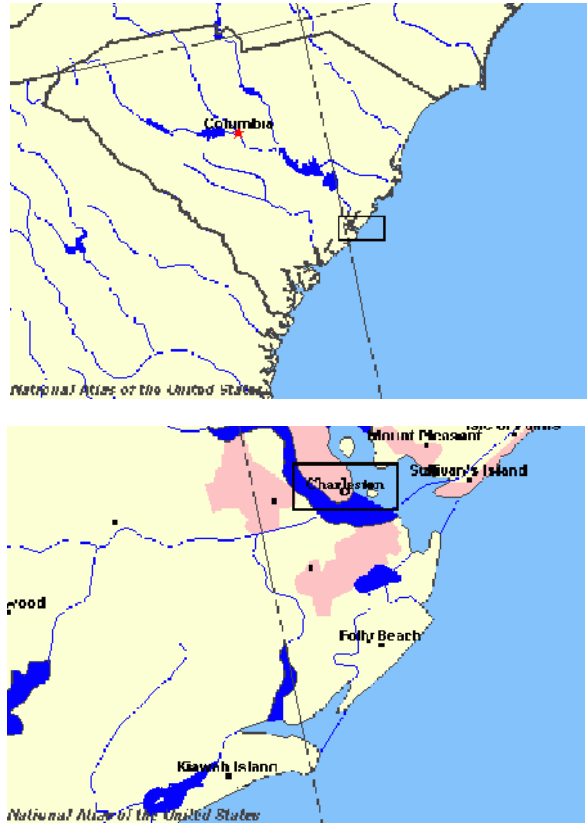

Figure 3. Major Bodies of Water Leading into the Test Area

Table 2. Expected Ranges of Water Characteristics at the Planned Test Sites

Parameter	Mesocosm		Bay		Lake Edmunds	
	Low	High	Low	High	Low	High
pH	7.5	8.3	7.5	8.3	7.0	8.0
Turbidity	0.1 NTU	10 NTU	-	-	-	-
DO	2.0 mg/L	10.00 mg/L	2.5 mg/L	8.0 mg/L	-	-
Conductivity	0.0	36mS/cm2	-	-	-	-
Temperature	15C	35C	-	-	-	-
Nitrate	0.1 mg/L	1 mg/L	0.1 mg/L	1 mg/L	0.1 mg/L	1 mg/L
Chlorophyll A	5 ug/L	60 ug/L	5 ug/L	60 ug/L	5 ug/L	60 ug/L
Salinity	0 ppt	20 ppt	20 ppt	30 ppt	0 ppt	<1 ppt

"-" = no information

4.2 Multi-Parameter Water Probe Deployment

Probes will be set up in the 300-liter mesocosm tank at the Mesocosm Facility and prepared for a one-week test. Because of space considerations, more than one mesocosm tank may be used; but, in all cases, each probe will be provided with water from the same source, and each individual vendor's probes will be collocated within the same tank so that inter-unit reproducibility can be evaluated.

The saltwater test will take place on a portion of the Charleston Harbor located on the CCEHBR campus. The probes will be set up for a 30-day test. Each of the probes will be located within the same area, moored to the piling of the pier and accessible to CCEHBR staff for daily observation, reference measurements, and water sample collection.

The freshwater phase of the verification test will occur in Lake Edmunds on James Island, located approximately one mile from the CCEHBR facility.

Each vendor will be responsible for the initial setup of the probe at each test location unless written permission is given to CCEHBR or Battelle to set up the probe. Vendors may set up at the first site while training the appropriate Battelle or CCEHBR staff so that, during the next two deployments, the probes may be redeployed without vendor staff members present.

4.3 Mesocosm Testing

Mesocosm testing will be performed according to the schedule shown in Table 3. The mesocosms fill and drain with water daily, simulating a tide. Water samples will be collected at four intervals during each test day, spaced evenly throughout the normal operating hours of the facility (nominally 6 a.m. to 6 p.m.). During this period, the mesocosms will be manipulated to introduce variations in the measured parameters. The turbidity of the systems will be varied by operating a pump near the sediment trays to suspend additional solids in the water. Conductivity will be varied by adding freshwater to the saltwater during one of the fill-and-drain cycles.

Table 3. Schedule for Mesocosm Sample Collection

Task	Day 1					Day 2					Day 3					Day 4					Day 5				
	Sampling Time																								
	8am	10am	1pm	5pm	8am	10am	1pm	5pm	8am	10am	1pm	5pm	8am	10am	1pm	5pm	8am	10am	1pm	5pm	8am	10am	1pm	5pm	
Turbidity																									
Conductivity																									
Nitrate																									
Temperature																									
pH																									
Chlorophyll																									
DO																									

- A – Nitrate spike
- B – Stir sediment
- C – Add freshwater
- D – Nitrate spike
- E – Stir sediment

Nitrate will be varied by spiking the mesocosms with an appropriate amount of chemical during the fill cycle. Temperature, pH, and DO will be allowed to vary naturally, with any variations driven by natural forces and the changes in the other test parameters (for example nutrient spiking is likely to vary the corresponding chlorophyll A concentrations). The parameters will be varied over the ranges specified in Table 2 and monitored by the multi-parameter probes undergoing testing. During this period, each of the collected samples will be analyzed using a reference method for comparison. Three replicate samples will be collected from each tank per sampling event and each replicate analyzed for the parameters shown in Table 4. The average value of the three replicates will be reported as the reference value, along with the standard deviation.

Table 4. Sample Analysis Location

	Analysis Location
pH	on site
Turbidity	laboratory
DO	on site
Chlorophyll A	laboratory
Conductivity	on site
Temperature	on site
Nitrate	laboratory

4.4 Saltwater Testing

The saltwater test will occur at the Charleston Harbor site. This portion of the verification test will last for 30 days, during which time the probes will monitor the naturally occurring range of the target parameters, while samples for simultaneous reference measurements will be collected during each sampling event. Sample collection times will be rotated among the morning, afternoon, and evening throughout the test. In addition, two periods of intense sampling will occur at the beginning (Days 1 and 2) and the end (Days 29 and 30) of the sampling period, during which time samples will be taken at 30-minute intervals for eight

hours. For the first 15 days, the probes will be deployed to a depth of one to two feet. For the last 15 days, the probes will be deployed to a depth of 15 feet. At this site, samples for laboratory reference measurements will be taken using a Niskin sampling device, which allows a sample to be taken at depth. Three replicates will be taken per sampling event and each replicate analyzed. Temperature measurements will be taken at depth using a thermocouple on the end of a five-meter pole. The average value of the three replicates will be used as the reference value. Table 5 shows the recommended sampling times and numbers of sample events throughout the test period. The probes will be deployed by tethering them to the side of a bulkhead already located in the harbor. The probes from an individual vendor will be attached to the bulkhead so that they are as close to each other as possible and near the probes from the additional vendors participating in the test. If possible, the probes from each of the vendors will be located at the corners of a one-meter square frame, from which the probes will be hung.

4.5 Freshwater Testing

Freshwater testing will be done at Lake Edmunds. Because this site is more shallow than Charleston Harbor, only one depth will be used; however, the same sample collection schedule will be followed. This portion of the verification test will last for 30 testing days, during which time the probes will monitor the naturally occurring target parameters, while simultaneous reference measurements will be collected during each sampling event, again rotating among collection times. Two periods of intense sampling also will occur at the beginning (Days 1 and 2) and the end (Days 29 and 30) of the sampling period, during which time samples will be taken at 30-minute intervals for eight hours. Three replicates will be taken per sampling event and each replicate analyzed. The average value of the three replicates will be used as the reference value. Table 6 shows the recommended sampling times and numbers of samples to be collected throughout the test period.

Table 5. Schedule of Reference Method Sample Events on Each Day of Testing at the Charleston Harbor Site

Sampling Day	Morning	Afternoon	Evening	Total Sampling Events
Shallow Deployment				
1	6	6	4	16
2	6	6	4	16
3	1 ^a	1 ^b	1	3
4				0
5				0
6				0
7		1	1 ^c	2
8				0
9				0
10				0
11	1 ^c	1 ^a	1 ^b	3
12				0
13				0
14				0
15	1	1 ^a	1 ^b	3
Deep Deployment				
16	1	1 ^a		2
17				0
18				0
19	1 ^b	1	1	3
20				0
21				0
22		1 ^a	1 ^b	2
23		1 ^a		1
24				0
25	1 ^a			1
26	1 ^a			1
27				0
28		1 ^c	1 ^b	2
29	6	6	4	16
30	6	6	4	16

^a Sample to be split into a laboratory replicate

^b Field blank taken simultaneously

^c Field spike taken simultaneously

Table 6. Schedule of Reference Method Sample Events on Each Day of Testing at the Lake Edmunds Site

Sampling Day	Morning	Afternoon	Evening	Total Sampling Events
Shallow Deployment				
1	6	6	4	16
2	6	6	4	16
3	1 ^a	1 ^b	1	3
4				0
5				0
6				0
7		1	1 ^c	2
8				0
9				0
10				0
11	1	1 ^a	1 ^b	3
12				0
13				0
14				0
15	1 ^c	1 ^a	1 ^b	3
16	1	1 ^a		2
17				0
18				0
19	1 ^b	1	1	3
20				0
21				0
22		1	1 ^b	2
23		1 ^a		1
24				0
25	1 ^a	1	1 ^c	3
26				0
27				0
28		1	1 ^b	2
29	6	6	4	16
30	6	6	4	16

^a Sample to be split into a laboratory replicate

^b Field blank taken simultaneously

^c Field spike taken simultaneously

Lake Edmunds is shallow; and, therefore, the probes can be deployed by driving large posts into the bottom of the pond and tethering the instruments onto the posts with cable ties. While wearing appropriate gear, the testers will be able to wade into the pond and force the posts into the bottom with a sledgehammer. This method has been used often at the same site, and there have been no problems in the past while using other instrumentation in the ponds. Sample collection at the freshwater site will be done without entering the water to limit errors induced by disturbing the water during sampling.

4.6 Multi-Parameter Water Probe Calibration

Pre- and postcalibration of the multi-parameter water probes will be done for each measured parameter according to that vendor's instruction manual. This calibration will use NIST-traceable standards when applicable. Vendors may choose to supply the necessary calibration solutions and devices specific to the probe being verified.

4.7 Reference Methods

Reference measurements taken during this verification test will be presented, along with the data obtained during the pre- and postcalibration results.

4.7.1 pH

A National Institute of Standards and Technology (NIST)-traceable handheld pH meter from Oakton will be operated according to the manufacturer's instructions.

4.7.2 Turbidity

A Hach Ratio XR turbidity meter will be operated according to the manufacturer's instructions.

4.7.3 Dissolved Oxygen

DO will be measured using a NIST-traceable commercially available probe, operated according to the manufacturer's instructions.

4.7.4 Nitrate

Nitrate concentrations will be determined colorimetrically using a Lachat Instruments QuikChem autoanalyzer operated according to the manufacturer's instructions. The University of South Carolina uses QuikChem® Method 31-107-04-1-D⁽³⁾ for this determination. The method is included in Appendix A.

4.7.5 Chlorophyll A

Chlorophyll A concentrations will be determined using a fluorescence technique on a Turner 10-AU fluorometer operated according to the manufacturer's instructions. The method for this determination is the SOP used at CCEHBR. This SOP, based on EPA Method 445.0, is included in Appendix A.

4.7.6 Conductivity

A NIST-traceable handheld Orion conductivity meter (mS) will be operated according to the manufacturer's instructions.

4.7.7 Temperature

A NIST-traceable handheld thermocouple and readout will be used to monitor the water temperature (°C). This thermocouple will be used according to the manufacturer's instructions.

5. Material and Equipment

5.1 Reagents

Reagents to be used include distilled deionized water (for field blanks), a Hach Ratio XR turbidity standard from Advanced Polymer Systems (level, purity, etc.), a chlorophyll A standard from Sigma (C6144), a nitrate standard, and preservation reagents, as specified in the methods in Appendix A.

5.2 Sampling Equipment and Handling

Sampling equipment will consist of 0.5- or 1-L sample containers (glass bottles) and the Niskin sampling device being provided by CCEHBR, along with all sample storage equipment. The recommended maximum sample holding time is given in Table 7.

Table 7. Maximum Holding Time

	Holding Time
pH	none ^a
Turbidity	24 hours
DO	none
Chlorophyll A	1 week
Conductivity	none
Temperature	none
Nitrate	2 weeks

^aSample analysis performed immediately after sample collection.

5.3 Reference Equipment

Reference equipment includes a handheld pH meter (Oakton), turbidity meter (Hach Ratio XR), autoanalyzer (Lachat Instruments QuikChem 8000), fluorometer (Turner 10-AU), handheld conductivity meter, handheld thermocouple, and a DO meter.

6. QUALITY ASSURANCE/QUALITY CONTROL

6.1 Calibration

Both the on-line and laboratory reference instrumentation to be used in this verification test will be calibrated by the CCEHBR test facility according to the SOPs and schedules in place at the test facility. Documentation of these calibration results will be provided to Battelle. The conductivity, DO, and pH meters will be calibrated before each sampling event. The auto-analyzers, turbidity meter, and fluorometer used to measure nitrate, turbidity, and chlorophyll A will be calibrated at each sample analysis period. The thermocouple will be calibrated in the six months prior to the test completion date.

6.2 Field Quality Control

To ensure that the sample collection and analysis procedures are properly controlled, a field blank and a laboratory replicate sample will be taken at the times shown in Tables 5 and 6. The field blank will be a container of deionized water taken to the field and then brought back to the laboratory. It will be analyzed in the same manner as the collected samples. The laboratory replicate sample will be collected once each week during a regular sampling period. These replicate samples will simply be the field sample split into two separate samples (containers) and analyzed by the same methods. The results from the replicate analysis should be within the accuracy reported in Table 8. The expected values for the field blanks are given in Table 9. In addition, sample spikes will be taken in distilled water on the schedule shown in Tables 5 and 6. Sample spikes will be taken for only nitrate. The nitrate spike will be at 0.5mg/L.

Table 8. Replicate Analysis Results

	Accuracy (\pm)
pH	0.1
Turbidity	5 NTU
DO	5%
Chlorophyll A	5%
Conductivity	5%
Temperature	1°C
Nitrate	10%

Table 9. Expected Values for Field Blanks

	Expected Maximum
Turbidity	1 NTU ^a
Chlorophyll A	3 x average of three blank filters
Nitrate	5 µg at N/L ^c

^a NTU = nephelometric turbidity unit

^b at P/L = atoms of phosphorus per liter

^c at N/L = atoms of nitrogen per liter

6.3 Sample Custody

Transportation for sample collection at the Lake Edmunds site will be provided by CCEHBR, and collected samples will be transported to the laboratory in an ice-filled cooler. All samples will be accompanied by the sample collection sheet and chain-of-custody form included in Appendix B.

6.4 Audits

Independent of test facility and EPA QA activities, Battelle will be responsible for ensuring that the following audits are conducted as part of this verification test.

6.4.1 Performance Evaluation Audits

A performance evaluation audit will be conducted to assess the quality of the reference measurements made in this verification test. Each type of reference measurement will be compared with an independent probe or a NIST-traceable standard that is independent of those used during the testing. The acceptance criteria for the results of this audit are noted below. This audit will be performed once during the verification test. Table 10 gives a summary of the audits to be performed.

Table 10. Summary of Performance Evaluation Audits

Audited Parameter	Audit Procedure	Acceptable Tolerance
pH	Independent monitor	±0.1 pH
Turbidity	Independent turbidity standard	±10%
DO	Independent monitor	±5%
Nitrate	Independent nitrate standard	±10%
Chlorophyll A	Independent chlorophyll standard	±10%
Conductivity	Independent monitor	±5%
Temperature	Independent monitor	±1°C

6.4.1.1 pH

The handheld pH meter from Oakton will be compared with another handheld pH meter made by a different manufacturer and operated according to the manufacturer’s instructions. A tolerance of ±0.1 pH unit is expected.

6.4.1.2 Turbidity

The measurement of an independent turbidity standard will be compared using the Hach turbidity meter. An agreement of within 10% in nephelometric turbidity units is expected.

6.4.1.3. Dissolved Oxygen

The DO measurement will be compared with a handheld DO monitor made by a different manufacturer. Agreement within 5% is expected.

6.4.1.4 Nitrate

A nitrate audit will be performed, using an independent nitrate standard, by delivering a spiked sample to the Lachat Instruments QuikChem autoanalyzer. Agreement between the results of this analysis and the spiked concentration is expected to be within 10%.

6.4.1.5 Chlorophyll A

A chlorophyll A audit will be performed, using an independent chlorophyll A standard, by delivering a diluted standard to the Turner 10-AU fluorometer. Agreement between the results of this analysis and the spiked concentration is expected to be within 10%

6.4.1.6 Conductivity

An independent handheld conductivity meter made by a different manufacturer will be used to perform the conductivity audit. Agreement between the results of this meter and those of the test reference meter is expected to be within 5%.

6.4.1.7 Temperature

A NIST-traceable mercury-in-glass thermometer will be used for the temperature performance audit. The comparison will be done on a sample of collected water. An agreement within $\pm 1^{\circ}\text{C}$ is expected.

6.4.2 Technical Systems Audits

Battelle's Quality Manager will perform a TSA at least once during this verification test. The purpose of this audit is to ensure that the verification test is being performed in accordance with the AMS Center QMP⁽¹⁾, this test/QA plan, published reference methods, and any SOPs used by the CCEHBR test facility. In this audit, the Battelle Quality Manager may review the reference methods used, compare actual test procedures to those specified or referenced in this plan, and review data acquisition and handling procedures. A TSA report will be prepared, including a statement of findings and the actions taken to address any adverse findings. The EPA ETV Quality Manager will receive a copy of Battelle's TSA report.

At EPA's discretion, EPA QA staff may also conduct an independent on-site TSA during the verification test. The TSA findings will be communicated to testing staff at the time of the audit and documented in a TSA report.

6.4.3 Data Quality Audits

Battelle's Quality Manager will audit at least 10% of the verification data acquired in the verification test. The Battelle Quality Manager will trace the data from initial acquisition, through reduction and statistical comparisons, to final reporting. All calculations performed on the data undergoing audit will be checked.

6.4.4 Assessment Reports

Each assessment and audit will be documented in accordance with Section 2.9.7 of the QMP for the AMS Center.⁽¹⁾ Assessment reports will include the following:

- ☐ Identification of any adverse findings or potential problems
- ☐ Response to adverse findings or potential problems
- ☐ Possible recommendations for resolving problems
- ☐ Citation of any noteworthy practices that may be of use to others
- Confirmation that solutions have been implemented and are effective.

6.5 Corrective Action

The Battelle Quality Manager, during the course of any assessment or audit, will identify to the technical staff performing experimental activities any immediate corrective action that should be taken. If serious quality problems exist, the Battelle Quality Manager is authorized to stop work. Once the assessment report has been prepared, the Verification Test Coordinator will ensure that a response is provided for each adverse finding or potential problem and will implement any necessary follow-up corrective action. The Battelle Quality Manager will ensure that follow-up corrective action has been taken.

7. DATA HANDLING AND REPORTING

7.1 Documentation and Records

A variety of data will be acquired and recorded electronically and manually by either Battelle or CCEHBR staff in this verification test. Operational information, required maintenance, and results from the reference methods will generally be documented in a

laboratory record book and on the data sheet/chain-of-custody form in Appendix B. In general, the results from the multi-parameter water probes will be recorded electronically. The electronic data stored on the probe will be collected by the field staff during each sampling event. Once collected, this data will reside at the test facility until the entire test is finished. All of the electronic raw data will then be transferred to Battelle Columbus where it will be permanently stored with the study binder, along with the rest of the study data. Table 11 summarizes the types of data to be recorded and the process for recording data. At the conclusion of the test, CCEHBR will be provided with an electronic copy of the raw data generated during the verification.

7.2 Data Review

Data generated by the test facility and vendors in the verification test will be provided to Battelle and will be reviewed by the Verification Test Coordinator before they are used to calculate, evaluate, or report verification results. All data are to be recorded directly in the laboratory record book as soon as they are available. Records are to be written in ink, written legibly, and have any corrections initialed by the person performing the correction. These data will include electronic data, entries in laboratory record books, operating data from the test facility, and equipment calibration records. The person performing the review will add his/her initials and the date to a hard copy of the record being reviewed within two weeks of the measurement. This hard copy will be placed in the files for this verification test by the Verification Test Coordinator. In addition, data calculations performed by Battelle will be spot-checked by Battelle technical staff to ensure that calculations are performed correctly.

Table 11. Summary of Data Recording Process

Data to be Recorded	Responsible Party	Where Recorded	How Often Recorded	Purpose of Data
Dates, times of test events	CCEHBR	Laboratory record books/data sheets	Start/end of test; at each change of a test parameter; at sample collection.	Used to organize/check test results; manually incorporate data into spreadsheets - stored in study binder
Test parameters	Battelle/ CCEHBR	Laboratory record books/data sheets	Each sample collection	Used to organize/check test results; manually incorporate data into spreadsheets - stored in study binder
Probe data - digital display - electronic output	CCEHBR CCEHBR	Data sheets Probe data acquisition system (data logger, PC, laptop, etc.).	Each sample collection; data downloaded at least once per day	Used to organize/check test results; incorporate data into electronic spreadsheets - stored in study binder
Reference monitor readings/reference analytical results	CCEHBR	Laboratory record book/data sheets or data management system, as appropriate	After each batch sample collection; data recorded after reference method performed	Used to organize/check test results; manually incorporate data into spreadsheets - stored in study binder
Reference calibration data	CCEHBR	Laboratory record books/data sheets/data acquisition system	Whenever zero and calibration checks are done	Document correct performance of reference methods
Performance evaluation audit results	Battelle	Laboratory record books/data sheets/DAS	At times of performance evaluation audits	Test reference methods with independent standards/measurements

7.3 Statistical Procedures

7.3.1 Pre- and Postcalibration Results

A tabulation of the pre- and postcalibration results will be presented, where applicable, for each of the measured parameters. The results will be expressed as percent change for a given time period (days). If not prohibited by the vendor's typical operating instructions, a weekly check of the calibration will be performed as well.

The results from the calibration checks will be summarized, and accuracy will be determined each time the calibration check is conducted. This accuracy will be reported as a percentage, calculated using the following equation:

$$A=1-(C_s-C_p)/C_s$$

Where C_s is the value of the standard and C_p is the value measured by the vendor's probe.

7.3.2 Relative Bias

Results from the multi-parameter water probes being verified will be compared to the results obtained from the reference analyses. Water samples will be analyzed by both the reference method and the probes being verified. The results for each sample will be recorded, and the accuracy will be expressed in terms of the relative bias (B), as calculated from the following equation:

$$B = \frac{C_p - \bar{C}_R}{\bar{C}_R} \times 100 \quad (2)$$

where C_p is the reading from the probe being verified, and $\overline{C_R}$ is the average of the duplicate reference measurements. This calculation will be performed for each reference sample analysis for each of the eight target water parameters (Table 2). Readings of pH will be converted to H^+ concentration, and temperature readings will be converted to absolute units prior to making this calculation. Relative bias will be assessed independently for each analyzer provided by a single vendor to determine inter-unit reproducibility.

7.3.3 Precision

The standard deviation (S) of the results for replicate measurements made during stable operation at the mesocosm will be calculated and used as a measure of probe precision at each sampling period:

$$S = \left[\frac{1}{n-1} \sum_{k=1}^n (C_k - \overline{C})^2 \right]^{1/2} \quad (3)$$

where n is the number of replicate samples, C_k is the concentration reported for the k^{th} measurement, and \overline{C} is the average concentration of the replicate samples, i.e.,

$$\% \text{RSD} = \frac{S}{\overline{C}} 100 \quad (4)$$

Precision will be calculated for each of the eight target water parameters. Probe precision will be reported in terms of the percent relative standard deviation of the series of measurements.

7.3.4 Linearity

For target water parameters with a sufficiently wide range of variation, linearity will be assessed by linear regression, with the analyte concentration measured by the reference method as independent variable and the reading from the analyzer being verified as dependent variable. Linearity will be expressed in terms of the slope, intercept, and coefficient of determination (r^2). Linearity for pH will be assessed by converting pH results to H^+ concentration before comparison. Linearity will be assessed separately for each unit of each water probe being tested and for each of the mesocosm, saltwater, and freshwater test sites.

7.3.5 Inter-Unit Reproducibility

The results obtained from identical units of each probe will be compiled independently for each analyzer and compared to assess inter-unit reproducibility. The results will be interpreted using a *t*-test, or other appropriate comparison, to assess whether significant differences exist between the units tested.

7.4. Reporting

The statistical comparisons that result from each of the tests described above will be conducted separately for each of the probes being tested, and information on the additional performance parameters will be compiled and reported. Separate verification reports will be prepared, each addressing a technology provided by one commercial vendor. Each report will show separate verification results from the duplicate probes undergoing testing, along with calculations of the inter-unit reproducibility of the technology. For each test, the verification report will present the test procedures and test data, as well as the results of the statistical evaluation of those data.

All interaction with the probes (such as during maintenance, cleaning, and calibration) will be noted at the time of the test and reported. In addition, descriptions of the data-recording procedures, consumables used, and required reagents will be presented in the report.

The verification report will briefly describe the ETV program, the AMS Center, and the procedures used in verification testing. These sections will be common to each verification report resulting from this verification test. The results of the verification test will then be stated quantitatively, without comparison to any other technology tested or comment on the acceptability of the technology's performance. The preparation of draft verification reports, review of reports by vendors and others, revision of the reports, final approval, and distribution of the reports will be conducted as stated in the "Generic Verification Protocol for the Advanced Monitoring Systems Center."⁽⁴⁾ Preparation, approval, and use of verification statements summarizing the results of this test also will be subject to the requirements of that same protocol.

8. HEALTH AND SAFETY

The CCEHBR test facility will provide appropriate safety instructions regarding potential hazards during the verification testing to Battelle, EPA, and vendor staff, both at the CCEHBR site and upon arrival at the test sites.

9. REFERENCES

1. "Quality Management Plan for the ETV Advanced Monitoring Systems Center," Version 3.0, Environmental Technology Verification Program, Battelle, Columbus, Ohio, December 2001.
2. U.S. Environmental Protection Agency, "Environmental Technology Verification Program Quality and Management Plan for the Pilot Period (1995-2000)," EPA-600/R-98/064, Cincinnati, Ohio, May 1998.

3. QuikChem® Method 31-115-01-1-H, “Determination of Orthophosphate by Flow Injection Analysis,” January 4, 2001.
4. QuikChem® Method 31-107-04-1-D, “Determination of Nitrate and/or Nitrite in Brackish Waters by Flow Injection Analysis,” November 20, 2000.
5. “Generic Verification Protocol for the Advanced Monitoring Systems Pilot,” Environmental Technology Verification Program, prepared by Battelle, Columbus, Ohio, October 1998.

Appendix A
SOPs and EPA Test Methods

METHOD 180.1

DETERMINATION OF TURBIDITY BY NEPHELOMETRY

Edited by James W. O'Dell
Inorganic Chemistry Branch
Chemistry Research Division

**Revision 2.0
August 1993**

**ENVIRONMENTAL MONITORING SYSTEMS LABORATORY
OFFICE OF RESEARCH AND DEVELOPMENT
U.S. ENVIRONMENTAL PROTECTION AGENCY
CINCINNATI, OHIO 45268**

METHOD 180.1

DETERMINATION OF TURBIDITY BY NEPHELOMETRY

1.0 SCOPE AND APPLICATION

- 1.1 This method covers the determination of turbidity in drinking, ground, surface, and saline waters, domestic and industrial wastes.
- 1.2 The applicable range is 0-40 nephelometric turbidity units (NTU). Higher values may be obtained with dilution of the sample.

2.0 SUMMARY OF METHOD

- 2.1 The method is based upon a comparison of the intensity of light scattered by the sample under defined conditions with the intensity of light scattered by a standard reference suspension. The higher the intensity of scattered light, the higher the turbidity. Readings, in NTU's, are made in a nephelometer designed according to specifications given in Sections 6.1 and 6.2. A primary standard suspension is used to calibrate the instrument. A secondary standard suspension is used as a daily calibration check and is monitored periodically for deterioration using one of the primary standards.
 - 2.1.1 Formazin polymer is used as a primary turbidity suspension for water because it is more reproducible than other types of standards previously used for turbidity analysis.
 - 2.1.2 A commercially available polymer primary standard is also approved for use for the National Interim Primary Drinking Water Regulations. This standard is identified as AMCO-AEPA-1, available from Advanced Polymer Systems.

3.0 DEFINITIONS

- 3.1 **Calibration Blank (CB)** -- A volume of reagent water fortified with the same matrix as the calibration standards, but without the analytes, internal standards, or surrogates analytes.
- 3.2 **Instrument Performance Check Solution (IPC)** -- A solution of one or more method analytes, surrogates, internal standards, or other test substances used to evaluate the performance of the instrument system with respect to a defined set of criteria.
- 3.3 **Laboratory Reagent Blank (LRB)** -- An aliquot of reagent water or other blank matrices that are treated exactly as a sample including exposure to all glassware, equipment, solvents, reagents, internal standards, and surrogates that are used with other samples. The LRB is used to determine if method

analytes or other interferences are present in the laboratory environment, the reagents, or the apparatus.

- 3.4 **Linear Calibration Range (LCR)** -- The concentration range over which the instrument response is linear.
- 3.5 **Material Safety Data Sheet (MSDS)** -- Written information provided by vendors concerning a chemical's toxicity, health hazards, physical properties, fire, and reactivity data including storage, spill, and handling precautions.
- 3.6 **Primary Calibration Standard (PCAL)** -- A suspension prepared from the primary dilution stock standard suspension. The PCAL suspensions are used to calibrate the instrument response with respect to analyte concentration.
- 3.7 **Quality Control Sample (QCS)** -- A solution of the method analyte of known concentrations that is used to fortify an aliquot of LRB matrix. The QCS is obtained from a source external to the laboratory, and is used to check laboratory performance.
- 3.8 **Secondary Calibration Standards (SCAL)** -- Commercially prepared, stabilized sealed liquid or gel turbidity standards calibrated against properly prepared and diluted formazin or styrene divinylbenzene polymers.
- 3.9 **Stock Standard Suspension (SSS)** -- A concentrated suspension containing the analyte prepared in the laboratory using assayed reference materials or purchased from a reputable commercial source. Stock standard suspension is used to prepare calibration suspensions and other needed suspensions.

4.0 INTERFERENCES

- 4.1 The presence of floating debris and coarse sediments which settle out rapidly will give low readings. Finely divided air bubbles can cause high readings.
- 4.2 The presence of true color, that is the color of water which is due to dissolved substances that absorb light, will cause turbidities to be low, although this effect is generally not significant with drinking waters.
- 4.3 Light absorbing materials such as activated carbon in significant concentrations can cause low readings.

5.0 SAFETY

- 5.1 The toxicity or carcinogenicity of each reagent used in this method has not been fully established. Each chemical should be regarded as a potential health hazard and exposure should be as low as reasonably achievable.
- 5.2 Each laboratory is responsible for maintaining a current awareness file of OSHA regulations regarding the safe handling of the chemicals specified in

this method. A reference file of Material Safety Data Sheets (MSDS) should be made available to all personnel involved in the chemical analysis. The preparation of a formal safety plan is also advisable.

- 5.3 Hydrazine Sulfate (Section 7.2.1) is a carcinogen. It is highly toxic and may be fatal if inhaled, swallowed, or absorbed through the skin. Formazin can contain residual hydrazine sulfate. Proper protection should be employed.

6.0 EQUIPMENT AND SUPPLIES

- 6.1 The turbidimeter shall consist of a nephelometer, with light source for illuminating the sample, and one or more photo-electric detectors with a readout device to indicate the intensity of light scattered at right angles to the path of the incident light. The turbidimeter should be designed so that little stray light reaches the detector in the absence of turbidity and should be free from significant drift after a short warm-up period.
- 6.2 Differences in physical design of turbidimeters will cause differences in measured values for turbidity, even though the same suspension is used for calibration. To minimize such differences, the following design criteria should be observed:
- 6.2.1 Light source: Tungsten lamp operated at a color temperature between 2200-3000°K.
- 6.2.2 Distance traversed by incident light and scattered light within the sample tube: Total not to exceed 10 cm.
- 6.2.3 Detector: Centered at 90° to the incident light path and not to exceed $\pm 30^\circ$ from 90°. The detector, and filter system if used, shall have a spectral peak response between 400 nm and 600 nm.
- 6.3 The sensitivity of the instrument should permit detection of a turbidity difference of 0.02 NTU or less in waters having turbidities less than 1 unit. The instrument should measure from 0-40 units turbidity. Several ranges may be necessary to obtain both adequate coverage and sufficient sensitivity for low turbidities.
- 6.4 The sample tubes to be used with the available instrument must be of clear, colorless glass or plastic. They should be kept scrupulously clean, both inside and out, and discarded when they become scratched or etched. A light coating of silicon oil may be used to mask minor imperfections in glass tubes. They must not be handled at all where the light strikes them, but should be provided with sufficient extra length, or with a protective case, so that they may be handled. Tubes should be checked, indexed and read at the orientation that produces the lowest background blank value.
- 6.5 Balance -- Analytical, capable of accurately weighing to the nearest 0.0001 g.

6.6 Glassware -- Class A volumetric flasks and pipets as required.

7.0 REAGENTS AND STANDARDS

- 7.1 Reagent water, turbidity-free: Pass deionized distilled water through a 0.45 μ pore size membrane filter, if such filtered water shows a lower turbidity than unfiltered distilled water.
- 7.2 Stock standard suspension (Formazin):
- 7.2.1 Dissolve 1.00 g hydrazine sulfate, $(\text{NH}_2)_2\text{H}_2\text{SO}_4$, (CASRN 10034-93-2) in reagent water and dilute to 100 mL in a volumetric flask. **CAUTION--carcinogen.**
- 7.2.2 Dissolve 10.00 g hexamethylenetetramine (CASRN 100-97-0) in reagent water and dilute to 100 mL in a volumetric flask. In a 100 mL volumetric flask, mix 5.0 mL of each solution (Sections 7.2.1 and 7.2.2). Allow to stand 24 hours at $25 \pm 3^\circ\text{C}$, then dilute to the mark with reagent water.
- 7.3 Primary calibration standards: Mix and dilute 10.00 mL of stock standard suspension (Section 7.2) to 100 mL with reagent water. The turbidity of this suspension is defined as 40 NTU. For other values, mix and dilute portions of this suspension as required.
- 7.3.1 A new stock standard suspension (Section 7.2) should be prepared each month. Primary calibration standards (Section 7.3) should be prepared daily by dilution of the stock standard suspension.
- 7.4 Formazin in commercially prepared primary concentrated stock standard suspension (SSS) may be diluted and used as required. Dilute turbidity standards should be prepared daily.
- 7.5 AMCO-AEPA-1 Styrene Divinylbenzene polymer primary standards are available for specific instruments and require no preparation or dilution prior to use.
- 7.6 Secondary standards may be acceptable as a daily calibration check, but must be monitored on a routine basis for deterioration and replaced as required.

8.0 SAMPLE COLLECTION, PRESERVATION AND STORAGE

- 8.1 Samples should be collected in plastic or glass bottles. All bottles must be thoroughly cleaned and rinsed with turbidity free water. Volume collected should be sufficient to insure a representative sample, allow for replicate analysis (if required), and minimize waste disposal.
- 8.2 No chemical preservation is required. Cool sample to 4°C .

- 8.3 Samples should be analyzed as soon as possible after collection. If storage is required, samples maintained at 4°C may be held for up to 48 hours.

9.0 QUALITY CONTROL

- 9.1 Each laboratory using this method is required to operate a formal quality control (QC) program. The minimum requirements of this program consist of an initial demonstration of laboratory capability and analysis of laboratory reagent blanks and other solutions as a continuing check on performance. The laboratory is required to maintain performance records that define the quality of data generated.

9.2 INITIAL DEMONSTRATION OF PERFORMANCE.

- 9.2.1 The initial demonstration of performance is used to characterize instrument performance (determination of LCRs and analysis of QCS).
- 9.2.2 Linear Calibration Range (LCR) -- The LCR must be determined initially and verified every six months or whenever a significant change in instrument response is observed or expected. The initial demonstration of linearity must use sufficient standards to insure that the resulting curve is linear. The verification of linearity must use a minimum of a blank and three standards. If any verification data exceeds the initial values by $\pm 10\%$, linearity must be reestablished. If any portion of the range is shown to be nonlinear, sufficient standards must be used to clearly define the nonlinear portion.
- 9.2.3 Quality Control Sample (QCS) -- When beginning the use of this method, on a quarterly basis or as required to meet data-quality needs, verify the calibration standards and acceptable instrument performance with the preparation and analysis of a QCS. If the determined concentrations are not within $\pm 10\%$ of the stated values, performance of the determinative step of the method is unacceptable. The source of the problem must be identified and corrected before continuing with on-going analyses.

9.3 ASSESSING LABORATORY PERFORMANCE

- 9.3.1 Laboratory Reagent Blank (LRB) -- The laboratory must analyze at least one LRB with each batch of samples. Data produced are used to assess contamination from the laboratory environment.
- 9.3.2 Instrument Performance Check Solution (IPC) -- For all determinations, the laboratory must analyze the IPC (a mid-range check standard) and a calibration blank immediately following daily calibration, after every tenth sample (or more frequently, if required) and at the end of the sample run. Analysis of the IPC solution and calibration blank immediately following calibration must verify that the instrument is

within $\pm 10\%$ of calibration. Subsequent analyses of the IPC solution must verify the calibration is still within $\pm 10\%$. If the calibration cannot be verified within the specified limits, reanalyze the IPC solution. If the second analysis of the IPC solution confirms calibration to be outside the limits, sample analysis must be discontinued, the cause determined and/or in the case of drift the instrument recalibrated. All samples following the last acceptable IPC solution must be reanalyzed. The analysis data of the calibration blank and IPC solution must be kept on file with the sample analyses data. NOTE: Secondary calibration standards (SS) may also be used as the IPC.

- 9.3.3 Where additional reference materials such as Performance Evaluation samples are available, they should be analyzed to provide additional performance data. The analysis of reference samples is a valuable tool for demonstrating the ability to perform the method acceptably.

10.0 CALIBRATION AND STANDARDIZATION

- 10.1 Turbidimeter calibration: The manufacturer's operating instructions should be followed. Measure standards on the turbidimeter covering the range of interest. If the instrument is already calibrated in standard turbidity units, this procedure will check the accuracy of the calibration scales. At least one standard should be run in each instrument range to be used. Some instruments permit adjustments of sensitivity so that scale values will correspond to turbidities. Solid standards, such as those made of lucite blocks, should never be used due to potential calibration changes caused by surface scratches. If a pre-calibrated scale is not supplied, calibration curves should be prepared for each range of the instrument.

11.0 PROCEDURE

- 11.1 Turbidities less than 40 units: If possible, allow samples to come to room temperature before analysis. Mix the sample to thoroughly disperse the solids. Wait until air bubbles disappear then pour the sample into the turbidimeter tube. Read the turbidity directly from the instrument scale or from the appropriate calibration curve.
- 11.2 Turbidities exceeding 40 units: Dilute the sample with one or more volumes of turbidity-free water until the turbidity falls below 40 units. The turbidity of the original sample is then computed from the turbidity of the diluted sample and the dilution factor. For example, if 5 volumes of turbidity-free water were added to 1 volume of sample, and the diluted sample showed a turbidity of 30 units, then the turbidity of the original sample was 180 units.
- 11.2.1 Some turbidimeters are equipped with several separate scales. The higher scales are to be used only as indicators of required dilution volumes to reduce readings to less than 40 NTU.

Note: Comparative work performed in the Environmental Monitoring Systems Laboratory - Cincinnati (EMSL-Cincinnati) indicates a progressive error on sample turbidities in excess of 40 units.

12.0 DATA ANALYSIS AND CALCULATIONS

- 12.1 Multiply sample readings by appropriate dilution to obtain final reading.
- 12.2 Report results as follows:

<u>NTU</u>	<u>Record to Nearest:</u>
0.0 - 1.0	0.05
1 - 10	0.1
10 - 40	1
40 - 100	5
100 - 400	10
400 - 1000	50
>1000	100

13.0 METHOD PERFORMANCE

- 13.1 In a single laboratory (EMSL-Cincinnati), using surface water samples at levels of 26, 41, 75, and 180 NTU, the standard deviations were ± 0.60 , ± 0.94 , ± 1.2 , and ± 4.7 units, respectively.
- 13.2 The interlaboratory precision and accuracy data in Table 1 were developed using a reagent water matrix. Values are in NTU.

14.0 POLLUTION PREVENTION

- 14.1 Pollution prevention encompasses any technique that reduces or eliminates the quantity or toxicity of waste at the point of generation. Numerous opportunities for pollution prevention exist in laboratory operation. The EPA has established a preferred hierarchy of environmental management techniques that places pollution prevention as the management option of first choice. Whenever feasible, laboratory personnel should use pollution prevention techniques to address their waste generation. When wastes cannot be feasibly reduced at the source, the Agency recommends recycling as the next best option.
- 14.2 The quantity of chemicals purchased should be based on expected usage during its shelf life and disposal cost of unused material. Actual reagent preparation volumes should reflect anticipated usage and reagent stability.
- 14.3 For information about pollution prevention that may be applicable to laboratories and research institutions, consult "Less is Better: Laboratory Chemical Management for Waste Reduction," available from the American

15.0 WASTE MANAGEMENT

- 15.1 The U.S. Environmental Protection Agency requires that laboratory waste management practices be conducted consistent with all applicable rules and regulations. Excess reagents, samples and method process wastes should be characterized and disposed of in an acceptable manner. The Agency urges laboratories to protect the air, water and land by minimizing and controlling all releases from hoods, and bench operations, complying with the letter and spirit of any waste discharge permit and regulations, and by complying with all solid and hazardous waste regulations, particularly the hazardous waste identification rules and land disposal restrictions. For further information on waste management consult the "Waste Management Manual for Laboratory Personnel," available from the American Chemical Society at the address listed in Section 14.3.

16.0 REFERENCES

1. Annual Book of ASTM Standards, Volume 11.01 Water (1), Standard D1889-88A, p. 359, (1993).
2. Standard Methods for the Examination of Water and Wastewater, 18th Edition, pp. 2-9, Method 2130B, (1992).

17.0 TABLES, DIAGRAMS, FLOWCHARTS AND VALIDATION DATA

TABLE 1. INTERLABORATORY PRECISION AND ACCURACY DATA

Number of Values Reported	True Value (T)	Mean (X)	Residual for X	Standard Deviation (S)	Residual for S
373	0.450	0.4864	0.0027	0.1071	-0.0078
374	0.600	0.6026	-0.0244	0.1048	-0.0211
289	0.65	0.6931	0.0183	0.1301	0.0005
482	0.910	0.9244	0.0013	0.2512	0.1024
484	0.910	0.9919	0.0688	0.1486	-0.0002
489	1.00	0.9405	-0.0686	0.1318	-0.0236
640	1.36	1.3456	-0.0074	0.1894	0.0075
487	3.40	3.2616	-0.0401	0.3219	-0.0103
288	4.8	4.5684	-0.0706	0.3776	-0.0577
714	5.60	5.6984	0.2952	0.4411	-0.0531
641	5.95	5.6026	-0.1350	0.4122	-0.1078

REGRESSIONS: $X = 0.955T + 0.54$, $S = 0.074T + 0.082$

**Ortho Phosphate
Method**

QuikChem® Method 31-115-01-1-H

**DETERMINATION OF ORTHOPHOSPHATE BY FLOW
INJECTION ANALYSIS**

Written by Krista Knepel and Karin Bogren

Applications Group

**Revision Date:
4 January 2001**

**LACHAT INSTRUMENTS
6645 WEST MILL ROAD
MILWAUKEE, WI 53218-1239 USA**

QuikChem® Method 31-115-01-1-H

Orthophosphorous in Seawaters

5 to 400 µg P/L

0.16 to 12.91 µM P/L

– Principle –

Ammonium molybdate and antimony potassium tartrate reacts in an acid medium with phosphate to form an antimony-phospho-molybdate complex. This complex is reduced to an intensely blue-colored complex by ascorbic acid. The color produced is proportional to the phosphate concentration in the sample. Though there is a density difference between seawater and reagent water the bias is less than 2%.

Though the method is written for seawater and brackish water it is also applicable to non-saline sample matrixes. The method is calibrated using standards prepared in deionized water. Once calibrated, samples of varying salinities (0 to 35 ppt) may be analyzed. The determination of background absorbance is necessary only for samples, which have color absorbing at 880 nm.

– Interferences –

1. Interferences caused by copper, arsenate and silicate are minimal relative to the orthophosphate determination because of the extremely low concentrations normally found in estuarine and coastal waters.
2. High iron can cause precipitation of and subsequent loss of phosphate from the dissolved phase.
3. Using ascorbic acid as the reductant, the color intensity is not influenced by variations in salinity. Stannous chloride reductant **does** show a significant salt effect.
4. Turbidity is removed by filtration.
5. Hydrogen sulfide effects, such as occur in samples from deep anoxic basins, can be treated by simple dilution since high sulfide concentrations are most often associated with high phosphate values.

– Special Apparatus –

Please see Parts and Price list for Ordering Information

1. Heating Unit
2. Glass calibration vials must be used for this method (Lachat Part No. 21304)

CONTENTS

1. SCOPE AND APPLICATION.....	1
2. INTERFERENCES	1
3. SAFETY	1
4. EQUIPMENT AND SUPPLIES	2
5. REAGENTS AND STANDARDS	2
5.1. PREPARATION OF REAGENTS.....	2
5.2. PREPARATION OF STANDARDS.....	4
6. SAMPLE COLLECTION, PRESERVATION AND STORAGE.....	4
7. PROCEDURE.....	5
7.1. CALIBRATION PROCEDURE.....	5
7.2. SYSTEM NOTES.....	5
8. DATA ANALYSIS AND CALCULATIONS.....	6
9. METHOD PERFORMANCE	6
10. REFERENCES.....	6
11. TABLE, DIAGRAMS, FLOWCHARTS, AND VALIDATION DATA.....	8
11.1. DATA SYSTEM PARAMETERS FOR QUIKCHEM 8000.....	8
11.2. SUPPORT DATA FOR QUIKCHEM 8000.....	9
11.3. ORTHOPHOSPHATE MANIFOLD DIAGRAM	14

QuikChem® Method 31-115-01-1-H

DETERMINATION OF ORTHOPHOSPHORUS BY FLOW INJECTION ANALYSIS

1. SCOPE AND APPLICATION

- 1.1. Though the method is written for seawater and brackish water, it is also applicable to non-saline sample matrixes. The method is calibrated using standards prepared in deionized water. Once calibrated, samples of varying salinities (0 to 35 ppt) may be analyzed. The determination of background is necessary only for samples, which have color absorbing at 880 nm.
- 1.2. The method is based on reactions that are specific for the orthophosphate ion.
- 1.3. The applicable range is 5 to 400 µg/L. The claimed method detection limit is 1.0 µg P/L. The method throughput is 48 injections per hour.

2. INTERFERENCES

- 2.1. Interferences caused by copper, arsenate and silicate are minimal relative to the orthophosphate determination because of the extremely low concentrations normally found in estuarine and coastal waters.
- 2.2. High iron can cause precipitation of and subsequent loss of phosphate from the dissolved phase.
- 2.3. Using ascorbic acid as the reductant, the color intensity is not influenced by variations in salinity. Stannous chloride reductant does show a significant salt effect.
- 2.4. Turbidity is removed by filtration.
- 2.5. Hydrogen sulfide effects, such as occur in samples from deep anoxic basins, can be treated by simple dilution since high sulfide concentrations are most often associated with high phosphate values.

3. SAFETY

- 3.1. The toxicity or carcinogenicity of each reagent used in this method has not been fully established. Each chemical should be regarded as a potential health hazard and exposure should be as low as reasonably achievable. Cautions are included for known extremely hazardous materials.
- 3.2. Each laboratory is responsible for maintaining a current awareness file of the Occupational Health and Safety Act (OSHA) regulations regarding the safe handling of the chemicals specified in this method. A reference file of Material Safety Data sheets (MSDS) should be made available to all personnel involved in the chemical analysis. The preparation of a formal safety plan is also advisable.
- 3.3. The following chemicals have the potential to be highly toxic or hazardous, for detailed explanation consult the MSDS.
 - 3.3.1. Sulfuric acid

4. EQUIPMENT AND SUPPLIES

- 4.1. Balance -- analytical, capable of accurately weighing to the nearest 0.0001 g.
- 4.2. Glassware -- Class A volumetric flasks and pipettes or plastic containers as required. Samples may be stored in plastic or glass.
- 4.3. Flow injection analysis equipment designed to deliver and react sample and reagents in the required order and ratios.
 - 4.3.1. Sampler
 - 4.3.2. Multichannel proportioning pump
 - 4.3.3. Reaction unit or manifold
 - 4.3.4. Colorimetric detector
 - 4.3.5. Data system
- 4.4. Special Apparatus
 - 4.4.1. Heating unit
 - 4.4.2. Glass calibration vials must be used in this method (Lachat Part No. 21304)
- 4.5. Phosphate-Free Glassware and Polyethylene Bottles
 - 4.5.1. All labware used in the determination must be low in residual phosphate to avoid sample or reagent contamination. Washing with 10% (v/v) HCl and thoroughly rinsing with distilled, deionized water was found to be effective.
 - 4.5.2. Use membrane or glass fiber filters, 0.45 μM nominal pore size and check for contamination by analyzing blanks.
 - 4.5.3. When degassing reagents, **DO NOT DEGAS USING AN INVASIVE PROCEDURE SUCH AS A WAND TO AVOID CONTAMINATION.** Degas by vacuum or sonication.

5. REAGENTS AND STANDARDS

5.1. PREPARATION OF REAGENTS

Use deionized water (10 megohm) for all solutions.

Degassing:

To prevent bubble formation, **DO NOT DEGAS USING AN INVASIVE PROCEDURE SUCH AS A WAND TO AVOID CONTAMINATION.** Degas by vacuum or sonication. **All reagents need to be thoroughly degassed.**

✓ Reagent 1. Stock Ammonium Molybdate Solution

The molybdate solid may take up to four hours on a stir plate to dissolve. Store in plastic and refrigerate. Discard after six months.

By Volume: In a 1 L volumetric flask, dissolve **40.0 g ammonium molybdate tetrahydrate** $[(\text{NH}_4)_6\text{Mo}_7\text{O}_{24}\cdot 4\text{H}_2\text{O}]$ in approximately **800 mL water**. Dilute to the mark and mix with a magnetic stirrer for at least four hours. Store in plastic and refrigerate.

By Weight: To a tared 1 L container add **40.0 g ammonium molybdate tetrahydrate** $[(\text{NH}_4)_6\text{Mo}_7\text{O}_{24}\cdot 4\text{H}_2\text{O}]$ and **983 g water**. Mix with a magnetic stirrer for a least four hours. Store in plastic and refrigerate.

✓ Reagent 2. Stock Antimony Potassium Tartrate Solution

By Volume: In a 1 L volumetric flask, dissolve **3.0 g antimony potassium tartrate** (potassium antimonyl tartrate hemihydrate $\text{K}(\text{SbO})\text{C}_2\text{H}_4\text{O}_6\cdot 1/2 \text{H}_2\text{O}$) or dissolve **3.22 g antimony potassium tartrate** (potassium antimonyl tartrate trihydrate $\text{C}_8\text{H}_4\text{O}_{12}\text{K}_2\text{Sb}_2\cdot 3\text{H}_2\text{O}$) in approximately **800 mL water**. Dilute to the mark and mix with a magnetic stirrer until dissolved. Store in a dark bottle and refrigerate.

By Weight: To a 1 L dark, tared container add **3.0 g antimony potassium tartrate** (potassium antimonyl tartrate hemihydrate $\text{K}(\text{SbO})\text{C}_2\text{H}_4\text{O}_6\cdot 1/2 \text{H}_2\text{O}$) or **3.22 g antimony potassium tartrate** (potassium antimonyl tartrate trihydrate $\text{C}_8\text{H}_4\text{O}_{12}\text{K}_2\text{Sb}_2\cdot 3\text{H}_2\text{O}$) and **995 g water**. Mix with a magnetic stirrer until dissolved. Store in a dark bottle and refrigerate.

Reagent 3. Molybdate Color Reagent

This reagent may be stored at room temperature. Discard when the solution turns blue.

By Volume: To a 1 L volumetric flask add **35.0 mL concentrated sulfuric acid** to about **500 mL water**, (CAUTION: The solution will get hot!) Swirl to mix. Add **213 mL Ammonium Molybdate Solution** (Reagent 1) and **72 mL Antimony Potassium Tartrate Solution** (Reagent 2). Dilute to the mark and invert to mix. Degas by vacuum or sonication.

By Weight: To a tared 1 L container add **680 g DI water** and **64.4 g concentrated sulfuric acid** (CAUTION: The solution will get hot!) Swirl to mix. Add **213 mL Ammonium Molybdate Solution** (Reagent 1) and **72 mL Antimony Potassium Tartrate Solution** (Reagent 2). Dilute to the mark and invert to mix. Degas by vacuum or sonication.

✓ Reagent 4. Ascorbic Acid Reducing Solution

By Volume: To a 1 L volumetric flask, dissolve **60.0 g granular ascorbic acid** (Spectrum Chemicals, Catalogue # AS-102) in about **700 mL DI water**. Dilute to the mark and invert to mix. Degas by vacuum or sonication for at least 5 minutes. Add **1.0 g sodium dodecyl sulfate** (SDS $\text{CH}_3(\text{CH}_2)_{11}\text{OSO}_3\text{Na}$). Degas prior to the addition of SDS. Prepare fresh weekly.

By Weight: To a tared 1 L container, add **60.0 g granular ascorbic acid** (Spectrum Chemicals, Catalogue # AS-102) and **975 g DI water**. Invert to mix. Degas by vacuum or sonication for at least 5 minutes. Add **1.0 g sodium dodecyl sulfate** (SDS $\text{CH}_3(\text{CH}_2)_{11}\text{OSO}_3\text{Na}$). Degas prior to the addition of SDS. Prepare fresh weekly ✕

✓ Reagent 5. Sodium Hydroxide – EDTA Rinse

Dissolve **65 g sodium hydroxide** (NaOH) and **6 g tetrasodium ethylenediamine tetraacetic acid** (Na_4EDTA) in **1.0 L or 1.0 kg DI water**. Use daily at the end of the day (~10 minutes, followed by a DI rinse) or if the baseline begins to drift upwards.

5.2. PREPARATION OF STANDARDS

To prepare the stock and working standards, the following containers will be requires:

By Volume: Three 1 L and five 250 mL volumetric flasks.

By Weight: Three 1 L and five 250 mL containers.

Standard 1. Stock Standard 1000 mg P/L

By Volume: In a 1 L volumetric flask dissolve **4.39 g potassium dihydrogenphosphate** (KH_2PO_4) in approximately 500 mL DI water. Dilute to the mark with DI water and invert to mix. This solution may be refrigerated and stored in glass for up to one month.

Standard 2. Working Standard 1 - 1000 μg P/L

By Volume: In a 1 L volumetric flask add 1 mL of Standard 1 (1000 mg P/L). Dilute to the mark with DI water and invert to mix. Prepare fresh daily.

Standard 3. Working Standard 2 – 100 μg P/L

By Volume: In a 1 L volumetric flask, add 100 mL of Working Standard 1 (1000 μg P/L). Dilute to the mark with DI water and invert to mix. Prepare fresh daily.

Working Standards (Prepare Daily)	A	B	C	D	E	F
Concentration μg P/L	400	200	100	25	5	0.0

By Volume

Volume (mL) of Working standard 1 diluted to 250 mL with DI water	100	50	---	---	---	---
Volume (mL) of Working standard 2 diluted to 250 mL with DI water	---	---	250	62.5	12.5	---

By Weight

Weight (g) of Working standard 1 diluted to final weight (~250 g) divided by factor below with DI water	100	50	---	---	---	---
Weight (g) Working standard 2 diluted to final weight (~250 g) divided by factor below with DI water	---	---	250	62.5	12.5	---
Division Factor Divide exact weight of the standard by this factor to give the final weight	0.4	0.2	---	0.25	0.05	---

6. SAMPLE COLLECTION, PRESERVATION AND STORAGE

- 6.1. Analysis should be commenced within two hours of sample collection. Glass bottles should be used, unless acceptable storage stability studies have been completed with plastic bottles. If long term storage is necessary, samples should be filtered on-site with

- 0.45 μM pore size membrane filters (washed with greater than 200 mL of sample) and frozen at -10°C . Samples should be frozen in plastic bottles leaving about 30% headspace for expansion. Frozen samples may be stored for up to three months.
- 6.2. Thaw samples by immersion in warm water with occasional mixing to ensure uniform sample temperature. Do not warm samples above ambient temperature. Since the analyte is in the liquid portion of the thawing, care should be taken to ensure complete thawing.
 - 6.3. Samples should be collected in plastic or glass bottles. All bottles must be thoroughly cleaned and rinsed with reagent water. The volume collected should be sufficient to insure a representative sample, allow for replicate analysis (if required), and minimize waste disposal.
 - 6.4. If samples must be chemically preserved, add 2 mL of 8 N H_2SO_4 per liter of sample. Store in glass or polyethylene at 4°C . Analyze within two months.
 - 6.5. Some researchers have found serious errors when investigating the effects of filtration. Others have found phosphate to adsorb on the walls of polyethylene bottles. It is imperative that the analyst examines preservation techniques before routine testing.

7. PROCEDURE

7.1. CALIBRATION PROCEDURE

- 7.1.1. Prepare reagent and standards as described in section 5.
- 7.1.2. Set up manifold as shown in section 11.
- 7.1.3. Input data system parameters as shown in section 11.
- 7.1.4. Pump DI water through all reagent lines and check for leaks and smooth flow. Switch to reagents and allow the system to equilibrate until a stable baseline is achieved.
- 7.1.5. Place samples and/or standards in the sampler. Input the information required by the data system, such as concentration, replicates and QuikChem scheme (See section 11).
- 7.1.6. Calibrate the instrument by injecting the standards. The data system will then associate the concentrations with the instrument responses for each standard.

7.2. SYSTEM NOTES

- 7.2.1. For information on system maintenance and troubleshooting refer to the Troubleshooting Guide in the System Operation Manual. This guide is also available on request from Lachat.
- 7.2.2. Allow 15 minutes for the heating unit to warm up to 45°C .
- 7.2.3. Glassware contamination is a problem in low level phosphorus determination. Glassware should be washed with 1:1 HCl solution and rinsed with deionized water. Commercial detergents should rarely be needed but, if they are used, use special phosphate-free preparations for lab glassware.
- 7.2.4. Reagent recipes from other automated wet chemistry analyzers should not be substituted.

- 7.2.5. It is very important to use granular ascorbic acid as opposed to powder. If the ascorbic acid solution turns yellow upon preparation or storage it should be discarded.
- 7.2.6. Over time a blue film may accumulate on the walls of the flowcell and in the manifold tubing. This may be removed by pumping the manifold rinse solution (Reagent 5) for 5 minutes followed by rinsing DI water for 5 minutes.
- 7.2.7. The blank in this method should not give a peak. If the blank peak is negative, the carrier is contaminated. If the blank peak is positive, the blank is contaminated.
- 7.2.8. If samples are colored, this background can be subtracted. First calibrate in the normal manner. Next, replace the molybdate reagent with a solution containing 35 mL H₂SO₄/L. Finally, reanalyze the samples. The color interference concentration is then subtracted from the original determined concentration.

8. DATA ANALYSIS AND CALCULATIONS

- 8.1. Calibration is done by injecting standards. The data system will then prepare a calibration curve by plotting response versus standard concentration. Sample concentration is calculated from the regression equation.
- 8.2. Report only those values that fall between the lowest and highest calibration standards. Samples exceeding the highest standard should be diluted and reanalyzed.
- 8.3. Report results in µg P/L.

9. METHOD PERFORMANCE

- 9.1. The method support data are presented in section 11. This data was generated according to a Lachat Work Instruction during development of the method.
- 9.2. Although Lachat Instrument publishes method performance data, including MDL, precision, accuracy and carryover studies, we cannot guarantee that each laboratory will be capable of meeting such performance. Individual laboratory and instrument conditions, as well as laboratory technique play a major role in determining method performance. The support data serves as a guide of the potential method performance. Some labs may not be able to reach this level of performance for various reasons, while other labs may exceed it.

10. REFERENCES

- 10.1. 40 CFR, 136 Appendix B. Definition and Procedure for Determination of the Method Detection Limit. Revision 1.1.
- 10.2. Grasshoff, K., Methods of Seawater Analysis, Verlag Chemie, Federal Republic of Germany, Second Edition, 1976, 419 pages.
- 10.3. Murphy J. and Riley, J.P., A Modified Single Solution Method for the Determination of Phosphate in Natural Waters, Anal. Chim. Acta, Vol. 27, 1962, p. 31-36.
- 10.4. Murphy J. and Riley, J.P., the Storage of Seawater Samples for the Determination of Dissolved Inorganic Phosphate, Anal. Chim. Acta, Vol. 14, 1956, p. 318-319.

- 10.5. MacDonald, R.W. and F.A. McLaughlin. The Effect of Storage by Freezing on Dissolved Inorganic Phosphate, Nitrate and Reactive Silicate for Samples from Coastal and Estuarine Waters, Water Research, Vol. 16, 1982 p. 95-104.
- 10.6. Johnson, K., and Petty, R., Determination of Phosphate in Seawater by Flow Injection Analysis with Injection of Reagent, Analytical Chemistry, Vol. 54, 1982, p. 1185-1187.
- 10.7. Lachat Instruments Inc., QuikChem Method 31-115-01-1-F written by Amy Huberty and David Diamond on 29 December 1998.
- 10.8. Lachat Instruments Inc., QuikChem Method 31-115-01-1-G written by David Diamond on 30 December 1998.

11. TABLE, DIAGRAMS, FLOWCHARTS, AND VALIDATION DATA

11.1. DATA SYSTEM PARAMETERS FOR QUIKCHEM 8000

The timing values listed below are approximate and will need to be optimized using graphical events programming.

Sample throughput: 48 samples/h, 75 s/sample
Pump Speed: 35
Cycle Period: 75

Analyte Data:

Concentration Units: $\mu\text{g P/L}$
Chemistry: Brackish
Inject to BW Baseline Start 3.7 s
Inject to BW Baseline End 62.0 s
Inject to BW Integ Start 20.9 s
Inject to BW Integ End 27.3

Calibration Data:

Level	1	2	3	4	5	6
Concentration $\mu\text{g P/L}$	400	200	100	25	5	0

Calibration Rep Handling: Average
Calibration Fit Type: 2nd Order Polynomial
Weighting Method: None
Force through zero: No

Sampler Timing:

Min. Probe in Wash Period: 19 s
Probe in Sample Period: 45 s

Valve Timing:

Load Time: 0 s
Load Period: 30 s
Inject Period: 90 s

11.2. SUPPORT DATA FOR QUIKCHEM 8000

Calibration Data for Orthophosphorus

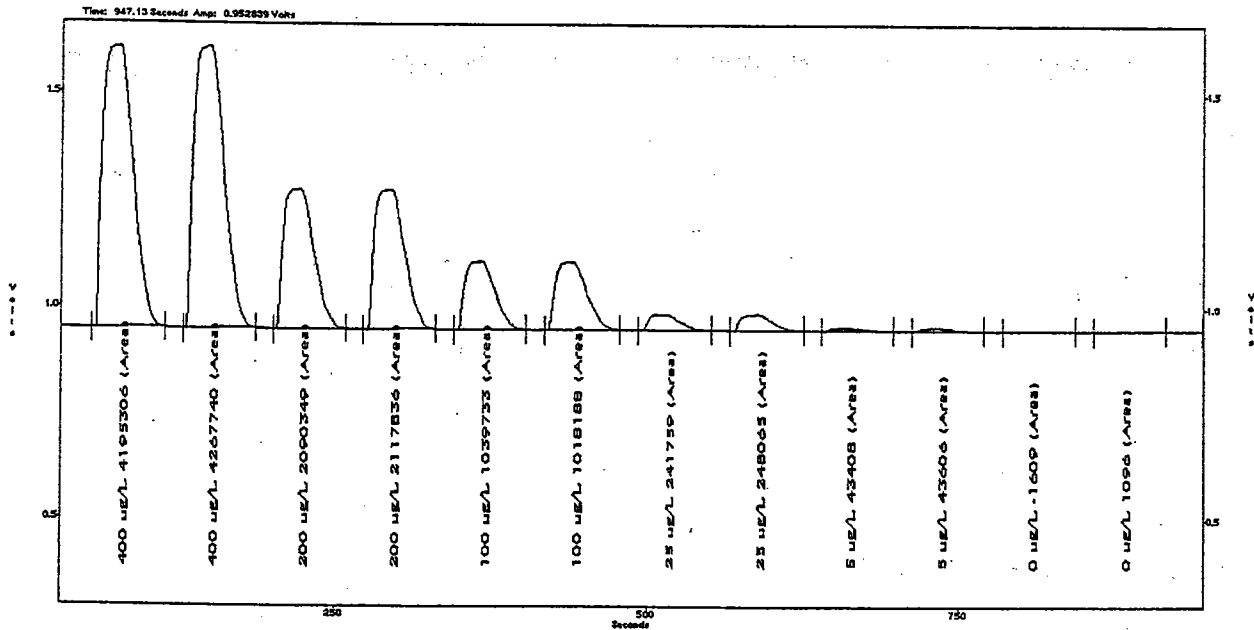

File Name: 201200c4.fdt
Acq. Date: 20 December 2000

Calibration Graph and Statistics

Level	Area	µg P/L	Determined	Replicate %RSD	% residual
1	4231523	400	395.2	1.2	0.0
2	2104093	200	199.82	0.9	-0.4
3	1028960	100	98.5	1.5	0.9
4	244912	25	24.55	1.8	2.7
5	43507	5	4.99	0.3	-1.1
6	-158	0	0	-1124.7	---

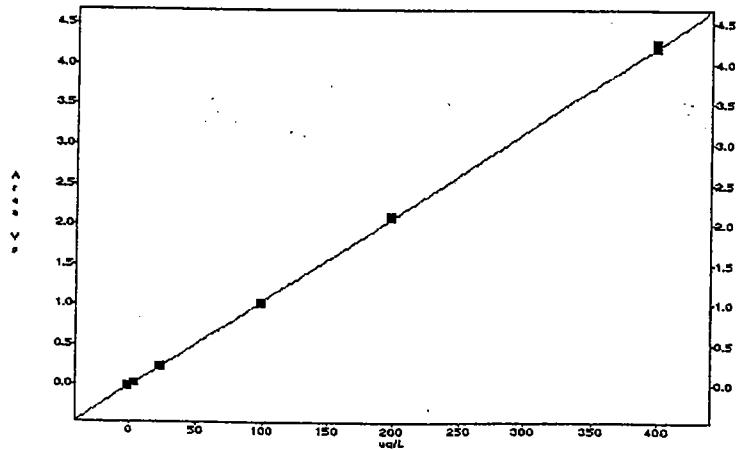

Scaling: None
Weighting: None
2nd Order Poly
Conc = $-3.489e-013 \text{ Area}^2 + 9.576e-005 \text{ Area} + 8.930e-001$
 $r = 1.0000$

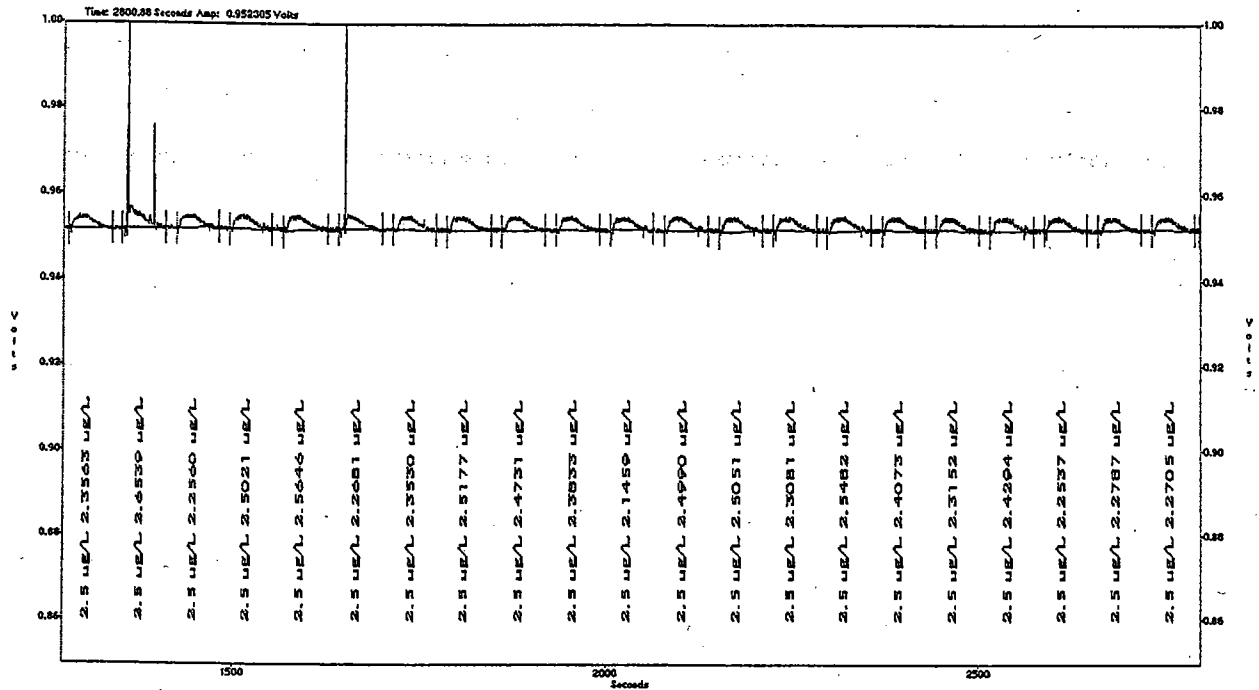

Method Detection Limit for Orthophosphorus using 2.5 µg P/L standard

MDL = 0.33 µg P/L * Claimed MDL is 1.0 µg P/L due to Y-intercept and carryover.

Standard Deviation (s) = 0.13 µg P/L, Mean (x) = 2.4 µg P/L, Known value = 2.5 µg/L

Acq. Date: 20 December 2000

File Name: 201200c3.fdt

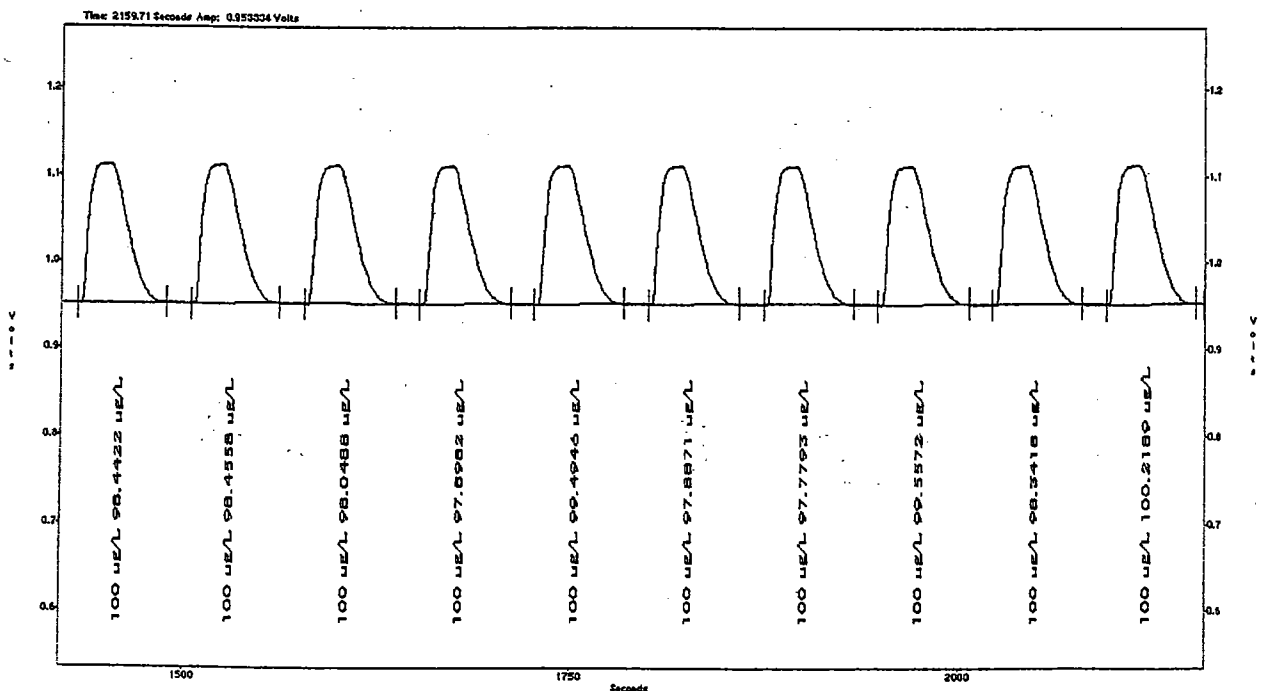

Precision data for Orthophosphorus using 100 µg P/L standard

% RSD = 0.86 %

Standard Deviation (s) = 0.85 µg P/L, Mean (x) = 98.6 µg P/L, Known value = 100 µg P/L

Acq. Date: 20 December 2000

File Name: 201200c4.fdt

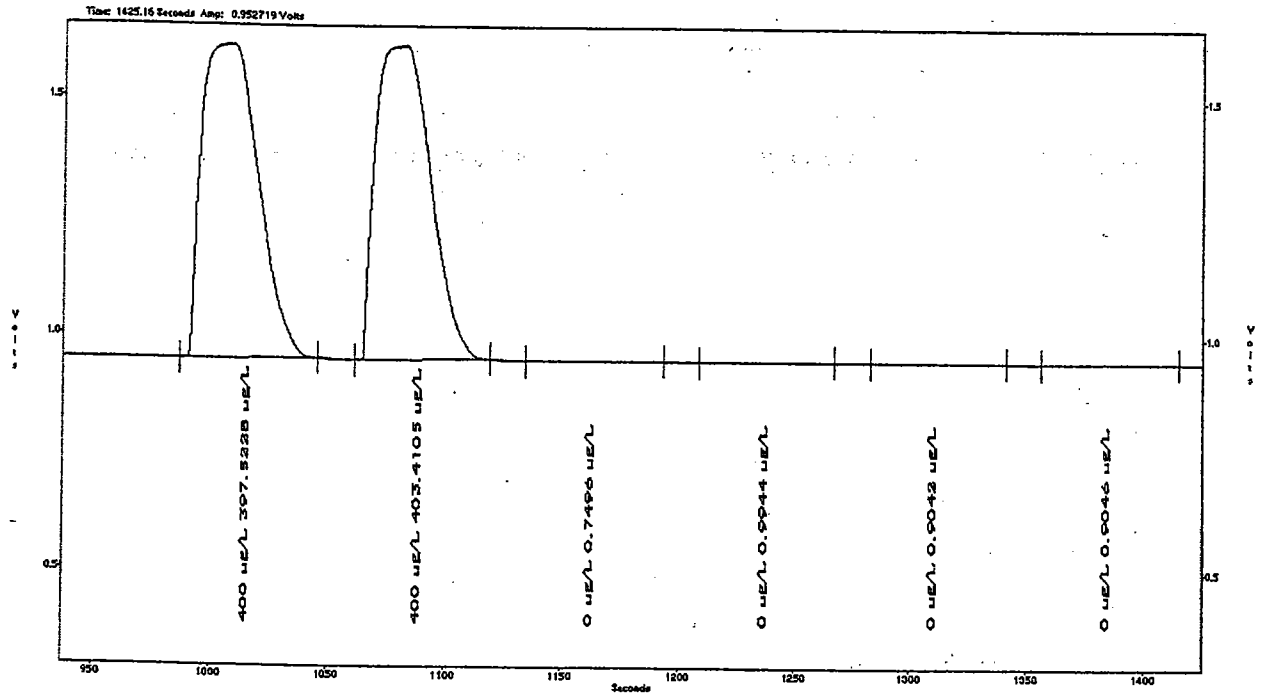

Carryover Study: 400 µg P/L standard followed by 4 blanks

Carryover Passed

Acq. Date: 20 December 2000

File Name: 201200c4.fdt

Various seawater samples showing different salinities and their spikes.

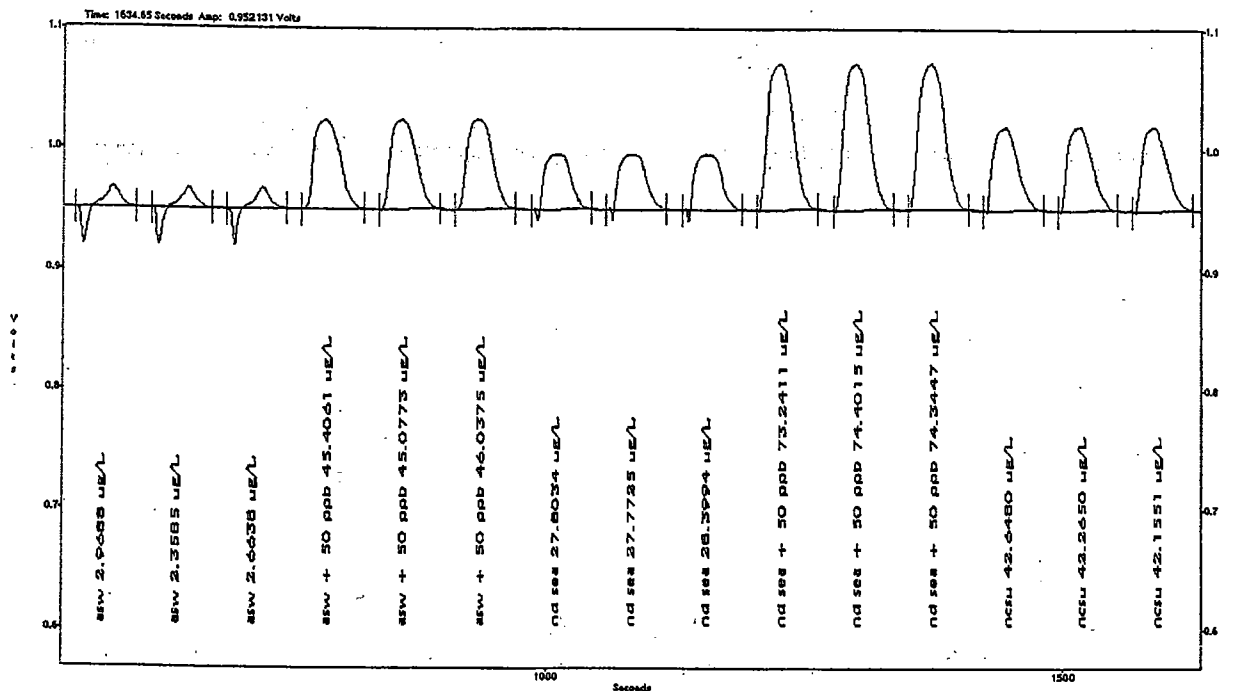

Acq. Date: 20 December 2000

File Name: 201200c6.fdt

Sample Type	Results µg P/L	Averages µg P/L	Spike Recoveries
Artificial Seawater	2.9688	2.6637	85.69%
	2.3585		
	2.6638		
Artificial Seawater plus 50 ppb spike	45.4061	45.5069	
	45.0773		
	46.0375		
*Nutrient Depleted Seawater	27.8034	27.992	92.01%
	27.7725		
	28.3994		
*Nutrient Depleted Seawater plus 50 ppb spike	73.2411	73.995	
	74.4015		
	74.3447		
*NCSU sample water	42.6480	42.356	---
	42.2650		
	42.1551		

*These samples were overrange. They were diluted after the spike with a 1:2 dilution to bring them within range.

Interference Study using Silicate Standard

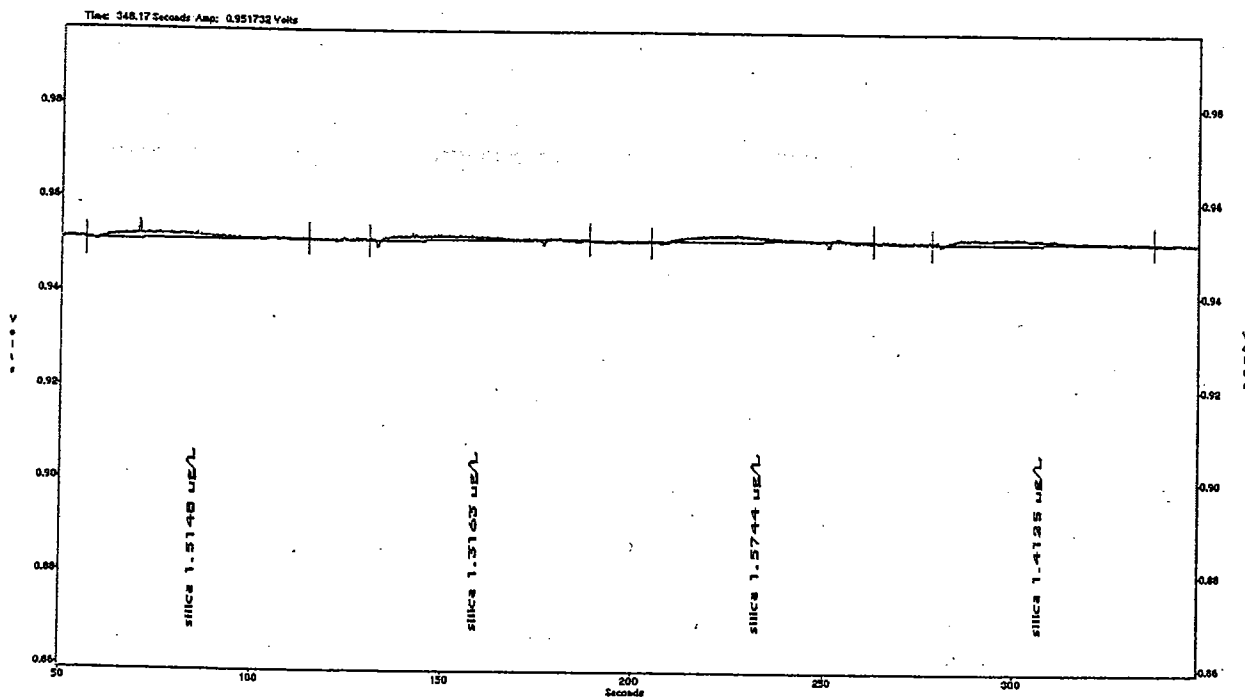

The selectivity of the method against silicate is 1172.4. For 1000 mg of silicate, the response would be 0.853 mg P/L. The amount of silicate in the above samples was 1700 $\mu\text{g Si/L}$.
Conclusion: Silicate is not a significant interferent in this method.

11.3. ORTHOPHOSPHATE MANIFOLD DIAGRAM

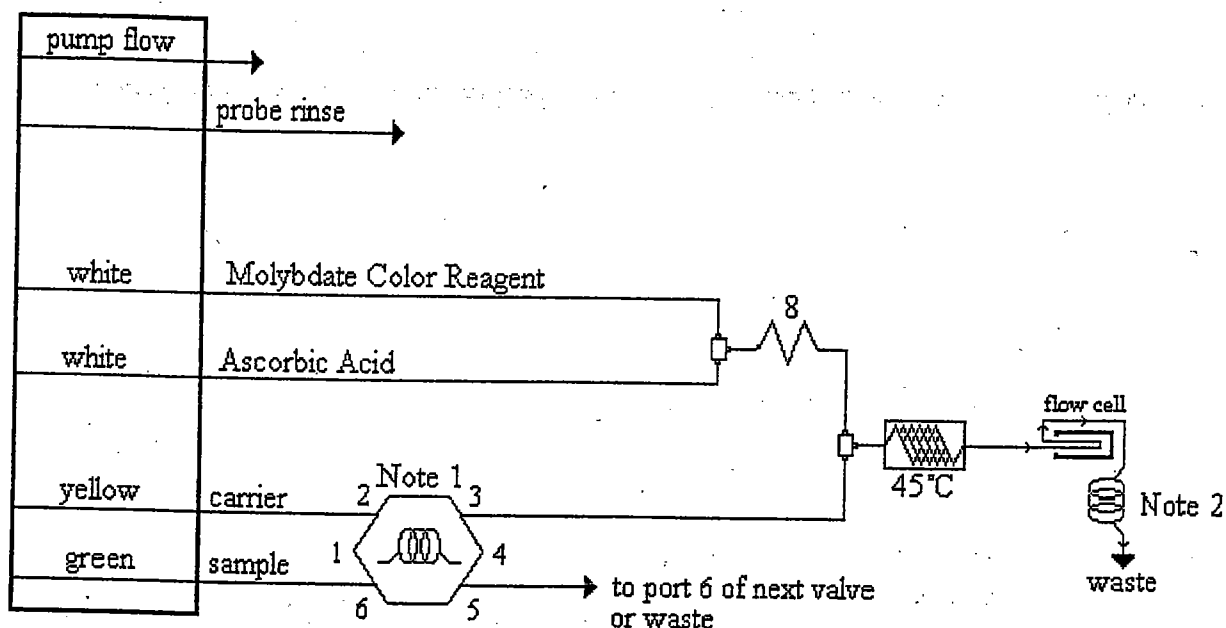

Carrier: DI water

Manifold Tubing: 0.8 mm (0.032 in) i.d. This is 5.2 $\mu\text{L}/\text{cm}$.

AE Sample Loop: 150 cm x 0.042 in i.d.

QC8000 Sample Loop: 150 cm x 0.042 in i.d.

Interference Filter: 880 nm

Apparatus: An injection valve, a 10 mm path length flow cell, and a colorimetric detector module is required. The  shows 175 cm of tubing wrapped around the heater block at the specified temperature.

8: 168 cm of tubing on a 8 cm coil support

Note 1: The sample loop should be cut on a 30°-45° angle for the best fit. One o-ring can also be used instead of 2.

Note 2: Backpressure coil of 200 cm x 0.5 mm (0.022 in) i.d.

Note 3: For the Cetac sampler: From the probe to the sample pump tube is 190 cm x 0.032 in i.d. From the sample pump tube to port 6 is 20 cm x 0.032 in i.d.

For the AI/Gilson samplers: From probe to sample pump tube is 130 cm x 0.032 in i.d. From the sample pump tube to port 6 is 20 cm x 0.032 in i.d.

Note 4: Glass calibration vials must be used with this method (Lachat Part No. 21304).

**Nitrate and Nitrite
Method**

QuikChem® Method 31-107-04-1-D

**DETERMINATION OF NITRATE AND/OR NITRITE IN BRACKISH
WATERS BY FLOW INJECTION ANALYSIS**

Written by Lynn Egan

Applications Group

**Revision Date:
20 November 2000**

**LACHAT INSTRUMENTS
6645 WEST MILL ROAD
MILWAUKEE, WI 53218-1239 USA**

QuikChem® Method 31-107-04-1-D
DETERMINATION OF NITRATE AND/OR NITRITE IN BRACKISH
WATER BY FLOW INJECTION ANALYSIS

0.5 to 14 µg N/L as NO₂ and/or NO₃ → #/14 = µM

(0.036-1 µM N as NO₂ and/or NO₃)

- Principle -

Nitrate is quantitatively reduced to nitrite by passage of the sample through a copperized cadmium column. The nitrite (reduced nitrate plus original nitrite) is then determined by diazotization with sulfanilamide under acidic conditions to form a diazonium ion. The diazonium ion is then coupled with N-(1-naphthyl)ethylenediamine dihydrochloride. The resulting pink dye absorbs at 540 nm. Nitrate concentrations are obtained by subtracting nitrite values, which have been previously analyzed, from the nitrite + nitrate values. Though the method is written for seawater and brackish water, it is also applicable to non-saline sample matrixes.

The method is calibrated using standards prepared in deionized water. Heat is used to improve linearity. Once calibrated, samples of varying salinities (0 to 35 ppt) may be analyzed. The determination of background absorbance is necessary only for samples that have color absorbing at 540 nm.

- Interferences -

1. Sample turbidity interferes. Remove turbidity by filtration with a 0.45 µm pore diameter membrane filter prior to analysis.
2. A positive error could be obtained for samples that contain high concentrations of iron, copper, or other metals. Na₂EDTA in the buffer helps to prevent this interference.
3. Samples that contain oil and grease will coat the surface of the cadmium, causing it to lose reduction efficiency. This interference can be eliminated by pre-extracting the sample with an organic solvent.
4. Sample color may be subtracted by analyzing the samples with a substitute color reagent, which does not contain the diazotizing agent. This is done by replacing the sulfanilamide-NED-phosphoric acid reagent with a solution containing 100 mL of phosphoric acid per liter.

- Special Apparatus -

Please see Parts and Price list for Ordering Information

1. Heating Unit
2. Cadmium Reduction Column (Lachat Part No. 50327 or 50327R)
3. 60 position racks for samples are required to allow replicate sample analyses from a single tube. XYZ with 60 Position rack (Lachat Part No. A81122 [110V]/A81222 [220V]); RAS A81136 [110V]/A81236 [220V])
4. Sample tubes are needed for 60 Position Samplers (Lachat Part No. 21042)
5. PVC pump tubes and RP-100 pump must be used with this method.

CONTENTS

1. SCOPE AND APPLICATION.....	2
2. INTERFERENCES	2
3. SAFETY	2
4. EQUIPMENT AND SUPPLIES	3
5. REAGENTS AND STANDARDS	3
5.1. PREPARATION OF REAGENTS	3
5.2. PREPARATION OF STANDARDS	5
6. SAMPLE COLLECTION, PRESERVATION AND STORAGE	6
7. PROCEDURE	7
7.1. CALIBRATION PROCEDURE	7
7.2. SYSTEM NOTES	7
8. DATA ANALYSIS AND CALCULATIONS	8
9. METHOD PERFORMANCE	9
10. REFERENCES	9
11. TABLE, DIAGRAMS, FLOWCHARTS, AND VALIDATION DATA	10
11.1. DATA SYSTEM PARAMETERS FOR QUIKCHEM 8000	10
11.2. SUPPORT DATA FOR QUIKCHEM 8000	11
11.3. NITRATE/NITRITE MANIFOLD DIAGRAM	15

QuikChem® Method 31-107-04-1-D

DETERMINATION OF NITRATE AND/OR NITRITE IN BRACKISH WATERS BY FLOW INJECTION ANALYSIS

1. SCOPE AND APPLICATION

- 1.1. This method covers the determination of nitrate/nitrite in brackish, seawater, or non-saline sample matrices.
- 1.2. The method is based on reactions that are specific for the nitrite (NO_2^-) ion.
- 1.3. The applicable range is 0.5 to 14.0 $\mu\text{g N/L}$ (0.036-1 μM). The method detection limit is 0.014 $\mu\text{M N}$ (0.20 $\mu\text{g N/L}$). The method throughput is 19 injections per hour.

2. INTERFERENCES

- 2.1. Sample turbidity will interfere by causing artificially high results. Remove turbidity by filtration with a 0.45 μm pore membrane filter prior to analysis.
- 2.2. A positive error could be obtained for samples that contain high concentrations of iron, copper, or other metals. Na_2EDTA in the buffer helps to prevent this interference.
- 2.3. Samples that contain oil and grease will coat the surface of the cadmium, causing it to lose reduction efficiency. This interference can be eliminated by pre-extracting the sample with an organic solvent.
- 2.4. Sample color may be subtracted by analyzing the samples with a substitute color reagent which does not contain the diazotizing agent. This is done by replacing the sulfanilamide-NED-phosphoric acid reagent with a solution containing 100 mL of phosphoric acid per liter.

3. SAFETY

- 3.1. The toxicity or carcinogenicity of each reagent used in this method has not been fully established. Each chemical should be regarded as a potential health hazard and exposure should be as low as reasonably achievable. Cautions are included for known extremely hazardous materials.
- 3.2. Each laboratory is responsible for maintaining a current awareness file of the Occupational Health and Safety Act (OSHA) regulations regarding the safe handling of the chemicals specified in this method. A reference file of Material Safety Data sheets (MSDS) should be made available to all personnel involved in the chemical analysis. The preparation of a formal safety plan is also advisable.
- 3.3. The following chemicals have the potential to be highly toxic or hazardous. For detailed explanations consult the MSDS.

- 3.3.1. Sodium hydroxide
- 3.3.2. Ammonium chloride
- 3.3.3. Phosphoric acid
- 3.3.4. Sulfanilamide
- 3.3.5. N-(1-naphthyl)-ethylenediamine (NED)
- 3.3.6. Cadmium
- 3.3.7. Ammonium hydroxide
- 3.3.8. Hydrochloric acid

4. EQUIPMENT AND SUPPLIES

- 4.1. Balance -- analytical, capable of accurately weighing to the nearest 0.0001 g.
- 4.2. Glassware -- Class A volumetric flasks and pipettes or plastic containers as required. Samples should be stored in plastic.
- 4.3. Flow injection analysis equipment designed to deliver and react sample and reagents in the required order and ratios.
 - 4.3.1. Sampler
 - 4.3.2. Multichannel proportioning pump
 - 4.3.3. Reaction unit or manifold
 - 4.3.4. Colorimetric detector
 - 4.3.5. Data system
- 4.4. Special Apparatus
 - ⊗ 4.4.1. Heating unit
 - 4.4.2. Cadmium Column (Lachat Part No. 50327 or 50327R)
 - 4.4.3. 60 position racks for samples are required to allow replicate sample analyses from a single tube. XYZ with 60 Position rack (Lachat Part No. A81122 [110V]/A81222 [220V]); RAS A81136 [110V]/A81236 [220V])
 - 4.4.4. Sample tubes are needed for 60 Position Samplers (Lachat Part No. 21042)
 - 4.4.5. PVC pump tubes and RP-100 pump must be used with this method.

5. REAGENTS AND STANDARDS

5.1. PREPARATION OF REAGENTS

Use deionized water (18 megohm-cm or greater is strongly recommended for successful trace-level analysis) for reagents, standards, carrier and washbath solution.

Degassing with helium:

To prevent bubble formation, degas all solutions except the standards with helium. Use He at 140kPa (20 lb/in²) through a helium degassing tube (Lachat Part No. 50100.) Bubble He through the solution for one minute. (Dedicated degassing tubes will prevent cross contamination).

Reagent 1. 15 N Sodium Hydroxide

By Volume: Add 150 g NaOH very slowly to about 125 mL of DI water in a 250 mL volumetric flask. **CAUTION:** This solution will get very hot! Stir until dissolved. Dilute to volume when cool. Store in a plastic bottle.

Reagent 2. Ammonium Chloride Buffer, pH 8.5

By Volume: In a 1 L volumetric flask, dissolve 85.0 g ammonium chloride (NH_4Cl) and 4.0 g disodium ethylenediamine tetra-acetic acid dihydrate ($\text{Na}_2\text{EDTA}\cdot 2\text{H}_2\text{O}$) in about 800 mL DI water. Dilute to the mark and invert to mix. Adjust the pH to 8.5 with 13 N sodium hydroxide solution.

By Weight: To a tared 1 L container, add 85.0 g ammonium chloride (NH_4Cl), 4.0 g disodium ethylenediamine tetraacetic acid dihydrate ($\text{Na}_2\text{EDTA}\cdot 2\text{H}_2\text{O}$) and 938 g DI water. Shake or stir until dissolved. Then adjust the pH to 8.5 with 13 N sodium hydroxide solution.

ACS grade ammonium chloride has been found occasionally to contain significant nitrate contamination. (The main symptom of this type of contamination would be a larger than normal increase in baseline when the cadmium column is placed in line). An alternative recipe for the ammonium chloride buffer is:

By Volume: **CAUTION:** Fumes!!! In a hood, to a 1 L volumetric flask, add 500 mL DI water, 105 mL concentrated hydrochloric acid (HCl), 95 mL ammonium hydroxide (NH_4OH), and 4.0 g disodium EDTA dihydrate. Dissolve and dilute to the mark. Invert to mix. Adjust the pH to 8.5 with HCl or 13 N NaOH solution.

By Weight: **CAUTION:** Fumes!!! In a hood, to a tared 1 L container, add 800 g DI water, 126 g concentrated hydrochloric acid (HCl), 85 g ammonium hydroxide (NH_4OH) and 4.0 g disodium EDTA dihydrate. Stir until dissolved. Adjust the pH to 8.5 with HCl or 13 N NaOH.

(Note: The ammonium chloride solution, pH 8.5, is used as a buffer prior to the reduction of NO_3^- to NO_2^- . At pH 8.5, ammonia gas is evolved and may cause contamination of reagents, standards, and samples in nearby ammonia, total nitrogen, or TKN determinations. For this reason, it is important to seal the buffer and waste containers with laboratory film, and to keep this container tightly closed when not in use).

Reagent 3. Sulfanilamide Color Reagent

By Volume: To a 1 L volumetric flask add about 600 mL DI water. Then add 100 mL 85% phosphoric acid (H_3PO_4), 40.0 g sulfanilamide and 5.0 g N-(1-naphthyl)-ethylenediamine dihydrochloride (NED). Shake to wet, and stir to dissolve for 30 min. Dilute to the mark, and invert to mix. Filter through a 0.45 μm filter prior to use. Store in a dark bottle and discard when the solution turns pink.

By Weight: To a tared, dark 1 L container add 875 g DI water, 170 g 85% phosphoric acid (H_3PO_4), 40.0 g sulfanilamide, and 5.0 g N-(1-naphthyl)ethylene-diamine dihydrochloride (NED). Shake until wetted and stir with a stir bar for 30 min. until dissolved. Filter through a 0.45 μm filter prior to use. Store in a dark bottle and discard when the solution turns pink.

Reagent 4: Artificial Seawater (ASW).

This solution contains the major constituents of seawater. (Alternatively, ammonia-free, low nutrient natural seawater can be used if available). This is used to determine brackish timing parameters. An ASW "blank" is injected, along with low-level spikes at one or two levels. (This tray must include a calibration for accurate results). While this reagent will contain some level of nitrate, low level spikes aid in determination of the proper area of the peak to integrate.

By Volume: In a 2 L volumetric flask, dissolve 58.6 g sodium chloride (NaCl), 18.8 g magnesium sulfate heptahydrate ($\text{MgSO}_4 \cdot 7\text{H}_2\text{O}$), and 0.44 g sodium bicarbonate (NaHCO_3) in about 1500 mL of DI water. Stir to mix and dilute to the mark.

By Weight: To a tared 2 L container, add 58.6 g sodium chloride (NaCl), 18.8 g magnesium sulfate heptahydrate ($\text{MgSO}_4 \cdot 7\text{H}_2\text{O}$), and 0.44 g sodium bicarbonate (NaHCO_3) to 1962 g of DI water. Stir to mix.

5.2. PREPARATION OF STANDARDS

To prepare the stock and working standards, the following containers will be required:

By Volume: Two 1 L, four 500 mL three 250 mL, and one 200 mL volumetric flasks

By Weight: Two 1 L, four 500 mL, three 250 mL and one 200 mL containers.

Standard 1. Stock Standard 100.0 mg N/L

Nitrate: In a 1 L volumetric flask dissolve 0.607 g sodium nitrate (NaNO_3) in about 800 mL water. Dilute to the mark and invert to mix. Refrigerate. Prepare Monthly.

Nitrite: In a 1 L volumetric flask dissolve 0.493 g sodium nitrite (NaNO_2) in about 800 mL water. Dilute to the mark and invert to mix. Refrigerate. Prepare weekly.

Standard 2. Stock Standard 10 mg N/L.

By Volume: To a 500 mL volumetric flask add 50 mL of Standard 1 (100 mg N/L as NO_3 or NO_2). Dilute to the mark with DI water and invert to mix. Prepare fresh daily.

Standard 3. Stock Standard 100 μg N/L as NO_3 or NO_2

By Volume: To a 500 mL volumetric flask add 5 mL of Standard 2 (10 mg N/L as NO_3 or NO_2). Dilute to the mark with DI water and invert to mix. Prepare fresh daily.

(Note: The 14 μg N/L as NO_2 is to be used for assessment of column efficiency. It, along with the 14 μg N/L as NO_3 standard should be analyzed when the column is exchanged or reduction efficiency is suspect. If nitrite alone is being analyzed, then only nitrite standards need to be prepared, and the reduction column is kept off-line during the analysis). If nitrate + nitrite are being measured, then nitrate standards and the 14 μg nitrite standard should be prepared.

Working Standards (Prepare Daily)	A	B	C	D	E	F
Concentration $\mu\text{g N/L}$ as NO_3 or NO_2	14	7	3.5	1.75	0.5	0.00

By Volume

Volume (mL) of stock standard 3 diluted to 250 mL with DI water	35	17.5	8.75		---	---
Volume (mL) of working standard C Diluted to 250 mL with DI water	---	---	---	125	---	---
Volume (mL) of stock standard 3 diluted to 200 mL with DI water	---	---	---	---	1.0	---

By Weight

Weight (g) of stock standard 3 diluted to final weight (~250 g) divided by factor below with DI water	35.0	17.5	8.75	---	---	---
Weight (g) of working standard C diluted to final weight (~250 g) divided by factor below with DI water	---	---	---	125	---	---
Weight (g) of stock standard 3 diluted to 200 mL with DI water	---	---	---	---	1.0	---
Division Factor Divide exact weight of the standard by this factor to give the final weight	0.14	0.07	0.035	0.5	0.005	---

6. SAMPLE COLLECTION, PRESERVATION AND STORAGE

- 6.1. Nitrite will be oxidized by air (O_2) to nitrate in a few days. If analysis cannot be made within 24 hours, the sample should be preserved by refrigeration at 4°C .
- 6.2. When samples must be stored for more than 24 hours, they should be preserved either with sulfuric acid (addition of a **maximum** of 2 mL of concentrated H_2SO_4 per liter) and stored refrigerated (at 4°C) or frozen. **CAUTION:** Samples must not be preserved with mercuric chloride or thiosulfate because this will degrade the cadmium column. Frozen samples must be completely thawed and be well mixed prior to analysis to obtain a representative sample.
- 6.3. Samples should be collected in plastic or glass bottles. All bottles must be thoroughly cleaned and rinsed with reagent water. The volume collected should be sufficient to ensure a representative sample, allow for replicate analysis (if required), and minimize waste disposal. (NOTE: If samples are to be analyzed for silicate as well, plastic containers must be used).

7. PROCEDURE

7.1. CALIBRATION PROCEDURE

- 7.1.1. Prepare reagents and standards as described in section 5.
- 7.1.2. Set up manifold as shown in section 11.
- 7.1.3. Input data system parameters as shown in section 11.
- 7.1.4. With the cadmium column off-line, pump DI water through all reagent lines and check for leaks and smooth flow. Switch to reagents and allow the system to equilibrate until bubbles are no longer visible in the manifold. Place the cadmium column in line, and allow reagents to pump until a stable baseline is achieved.
- 7.1.5. Place samples and/or standards in the sampler., Input the information required by the data system, such as concentration, replicates and QuikChem scheme (See section 11).
- 7.1.6. Calibrate the instrument by injecting the standards. The data system will then associate the concentrations with the instrument responses for each standard.
- 7.1.7. Because this is a trace level seawater method, which requires the use of brackish timing, **it is strongly recommended that a calibration be run with every tray.**
- 7.1.8. Standards may be chosen to bracket sample concentrations as long as the range of the method is not exceeded.

7.2. SYSTEM NOTES

- 7.2.1. For information on system maintenance and troubleshooting refer to the Troubleshooting Guide in the System Operation Manual. This guide is also available on request from Lachat.
- 7.2.2. When running this chemistry as part of a multi-channel method, the sequential filling of large-volume sample loops may limit the cycle time and consume extra sample. To prevent these effects, the sample stream is split prior to the pump by adding a tee at the pump inlet and using two red/red sample pump tubes in place of a single green/green one. This allows each sample line to feed 2-4 channels.
- 7.2.3. Reagent recipes from other automated wet chemistry analyzers should not be substituted. It is important to check column efficiency each time the column is replaced or when efficiency is suspect. Once the efficiency is known, a nitrite standard can be inserted in the sample tray to verify that the column remains efficient. To do this, a nitrate and nitrite standard of equal concentrations should be run side by side. If the value for nitrate does not fall within 90-110% the value obtained for nitrite, the column should be replaced.
- 7.2.4. Poor correlation coefficients are sometimes the result of sub-standard column performance. If the standards are freshly prepared and the calibration fails consistently, replace the column.
- 7.2.5. Because this method is for the measurement of trace levels of nitrate and/or nitrite, poor correlation coefficients may also be caused by improperly or carelessly prepared standards, contaminated standard or sample cups, or the use of water of less than optimum quality.

- 7.2.6. If sample tube or standard container materials other than polystyrene are used, standards and samples in these containers should be analyzed to investigate absorption or contamination.
- 7.2.7. The blank in this method should result in a very minute peak or no peak at all. If the blank peak is negative, the carrier is contaminated. If the blank peak is positive, the blank is contaminated. It is crucial that high-quality water be used for preparation of both reagents and standards (18.0 M Ω -cm or better is strongly suggested). Dilutions must also be very carefully carried out.
- 7.2.8. If samples are colored, this interference can be determined and subtracted. First, calibrate in the standard fashion. Next, replace the color reagent with a solution containing 100 mL H₃PO₄/L. Finally, reanalyze the samples. The determined concentration due to color interference can then be subtracted from the original determined concentration.
- 7.2.9. It is critical that the peak be detected on the "flat portion" of the seawater peaks. This is done by injecting a seawater blank. If the integration window is not on the "flat portion", the peak start time should be adjusted. Correct positioning can be tested by the use of ASW (or low nutrient seawater) as a blank and spiked at one or two low levels. Spike recoveries of 80-120% should be achieved.
- 7.2.10. To ascertain that the standard peak is properly positioned in the window, observe the peaks on screen. The baseline trace should be as flat as possible where the baseline start and stop times are set. If the peak is not properly positioned, adjust the timing.
- 7.2.11. For low level analysis it is recommended that samples be analyzed in duplicate from each sample cup. This is done by entering Replicates = 2 when entering sample information.
- 7.2.12. Due to low analyte levels, a noisy baseline will adversely affect the results. Pump tube wear will cause increased noise as well as changes in timing. Noise will also be increased by the use of unfiltered color reagent.
- 7.2.13. If spike recoveries in the seawater matrix are high, additional Na₂EDTA may be required in the ammonium chloride buffer reagent. (High spike recoveries are likely to be caused by precipitate formed at higher pH by cations. This precipitate appears to be signal from the analyte).

8. DATA ANALYSIS AND CALCULATIONS

- 8.1. Calibration is done by injecting standards. The data system will then prepare a calibration curve by plotting response versus standard concentration. Sample concentration is calculated from the regression equation.
- 8.2. Report only those values that fall between the lowest and highest calibration standards. Samples exceeding the highest standard should be diluted and reanalyzed.
- 8.3. Report results in $\mu\text{g N/L}$ or $\mu\text{M N}$.

9. METHOD PERFORMANCE

- 9.1. The method support data are presented in section 11. This data was generated according to a Lachat Work Instruction during development of the method.
- 9.2. Although Lachat Instruments publishes method performance data, including MDL, precision, accuracy and carryover studies, we cannot guarantee that each laboratory will be capable of meeting such performance. Individual laboratory and instrument conditions, as well as laboratory technique play a major role in determining method performance. The support data serves as a guide of the potential method performance. Some labs may not be able to reach this level of performance for various reasons, while other labs may exceed it.

10. REFERENCES

- 10.1 Grasshoff, K. Methods of Seawater Analysis, Verlag Chemie, Second Edition, 1976
- 10.2 Zimmerman, Carl. F. and Keefe, Carolyn W., EPA Method 353.4, Determination of Nitrate + Nitrite in Estuarine and Coastal Waters by Automated Colorimetric Analysis in An Interim Manual of Methods for the Determination of Nutrients in Estuarine and Coastal Waters., Revision 1.1, June 1991.
- 10.3 Johnson, K.S. and Petty, R.L., Determination of Nitrate and nitrite in Seawater by Flow Injection Analysis, *Limnol. Oceanogr.*, 28(6) p. 1260-1266
- 10.4 Anderson, Leif, Simultaneous Spectrophotometric Determination of Nitrite and Nitrate by Flow Injection Analysis, *Analytica Chimica Acta*, Vol. 110, 1979 p. 123 -128
- 10.5 Yamane, T. and Saito, M., Simple Approach for Elimination of Blank Peak Effects in Flow Injection Analysis of Samples Containing Trace Analyte and Excess of another Solute., *Talanta*, Vol. 39, No. 3, 1992 p. 215-219.
- 10.6 MacDonald, R.W. and F.A. McLaughlin. The Effect of Storage by Freezing on Dissolved Inorganic Phosphate, Nitrate, and Reactive Silicate for Samples from Coastal and Estuarine Waters, *Water Research*, Vol. 16, 1982 p. 95 - 104
- 10.7 Lachat Instruments Inc., QuikChem Method 31-107-04-1-C written by D. Diamond on 18 January 1994. Revised by L. Egan 27 June 2000.

11. TABLE, DIAGRAMS, FLOWCHARTS, AND VALIDATION DATA

11.1. DATA SYSTEM PARAMETERS FOR QUIKCHEM 8000

The timing values listed below are approximate and will need to be optimized using graphical events programming.

Sample throughput: 19 samples/h, 190 s/sample
Pump Speed: 35
Cycle Period: 190

Analyte Data:

Concentration Units: $\mu\text{g N/L}$ or $\mu\text{M N}$
Chemistry: Brackish
Inject to BW Baseline Start: 20.4 s
Inject to BW Baseline End: 209.4 s
Inject to BW Integ Start: 42 s
Inject to BW Integ End: 75 s

Calibration Data:

Level	1	2	3	4	5	6
Concentration $\mu\text{g N/L}$	14.0	7	3.5	1.75	0.5	0
Concentration $\mu\text{M N}$	1	0.5	0.25	0.125	0.036	0

Calibration Rep Handling: Average
Calibration Fit Type: 2nd Order Polynomial
Weighting Method: None
Force through zero: No

Sampler Timing:

Min. Probe in Wash Period: 9 s
Probe in Sample Period: 65 s

Valve Timing:

Load Time: 0 s
Load Period: 53 s
Inject Period: 137 s

11.2. SUPPORT DATA FOR QUIKCHEM 8000

Calibration Data for Nitrate/Nitrite

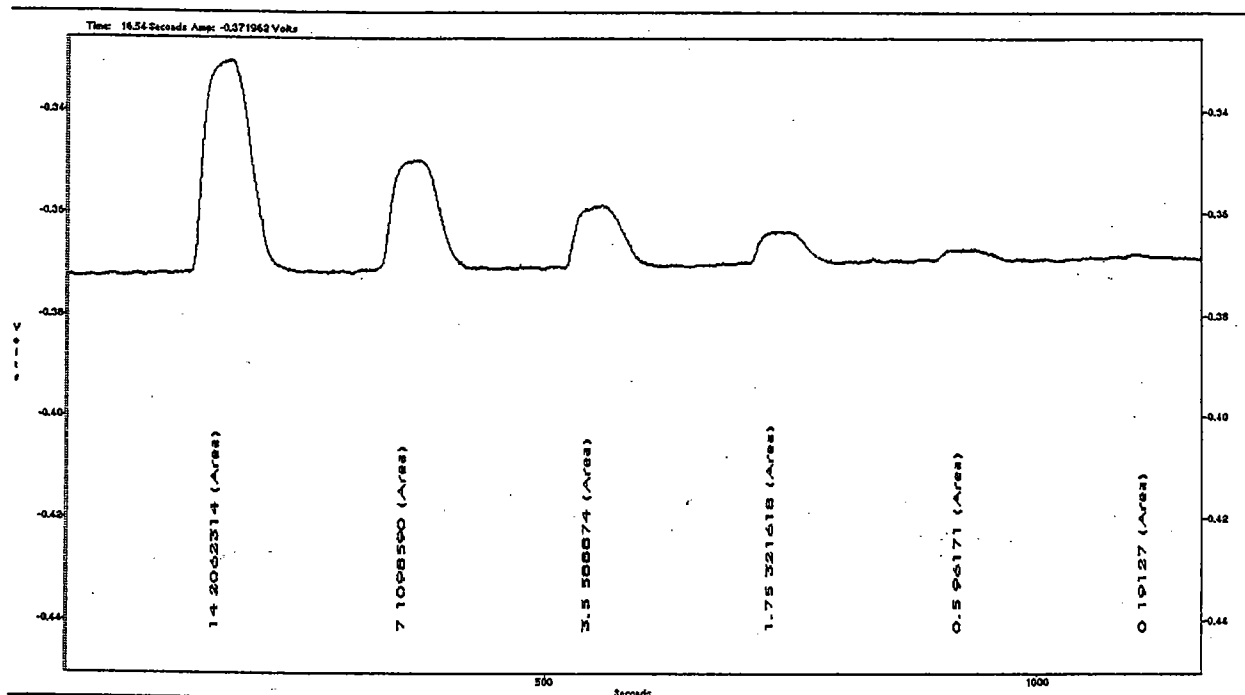

File Name: lno3pre3.fdt
Acq. Date: 16 November 2000

Calibration Graph and Statistics

Level	Area	$\mu\text{g N/L}$	Determined	% residual
1	2062314	14.00	14.028	-0.2
2	1098590	7.00	6.916	1.2
3	588874	3.50	3.51	-0.3
4	321618	1.75	1.83	-4.4
5	96171	0.5	0.46	8.0
6	19127	0	---	---

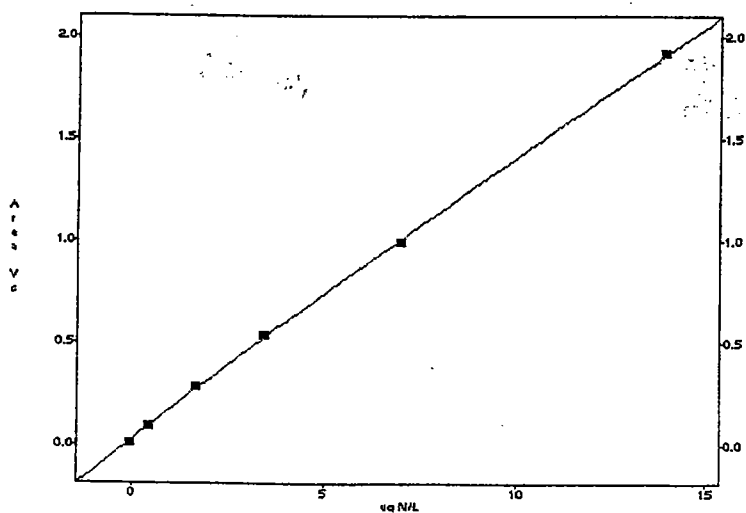

Scaling: None
Weighting: None
2nd Order Poly
Conc = $3.487\text{e-}013 \text{ Area}^2 + 6.711\text{e-}006 \text{ Area} - 1.724\text{e-}001$
 $r = 0.9999$

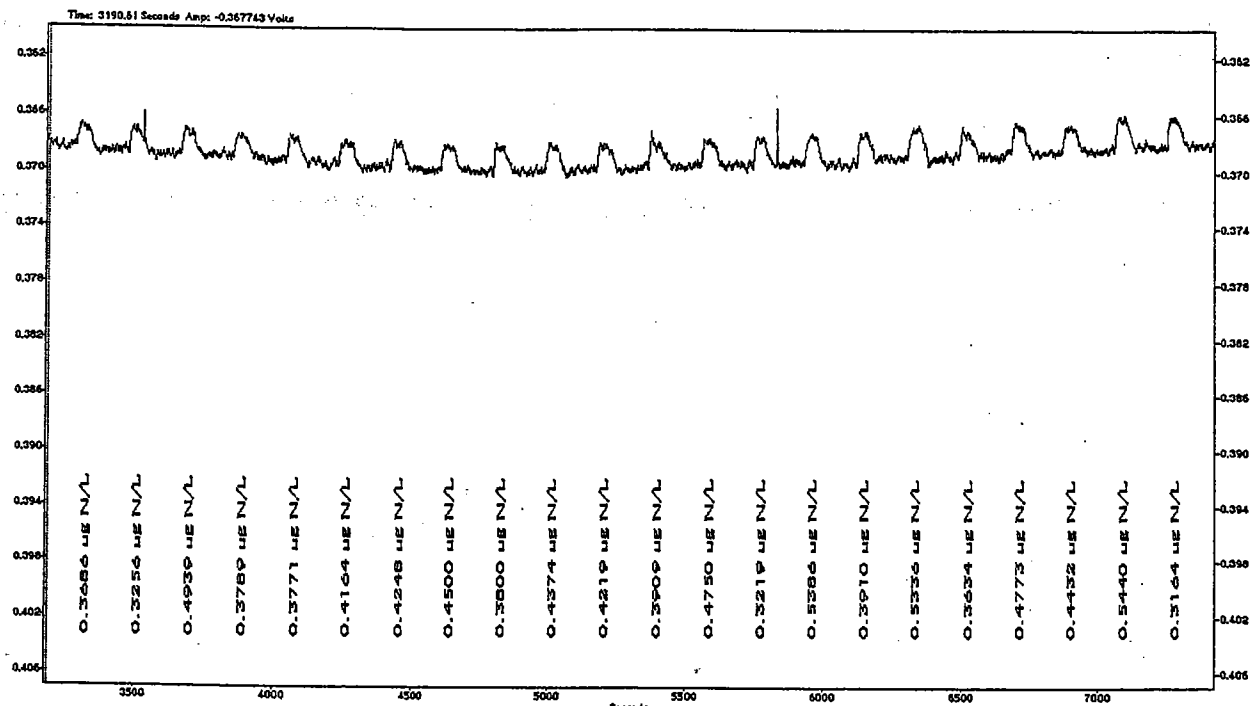

Method Detection Limit for Nitrate using 0.5 µg N/L standard

MDL= 0.20 µg N/L (0.014 µM N)*

Standard Deviation (s) = 0.068 µg N/L, Mean (x) = 0.382 µg N/L, Known value = 0.5 µg N/L, %RSD = 16.14

File Name: lno3pre3.fdt

Acq. Date: 16 November 2000

*Results are noise limited, and may be improved by the use of a longer cycle period

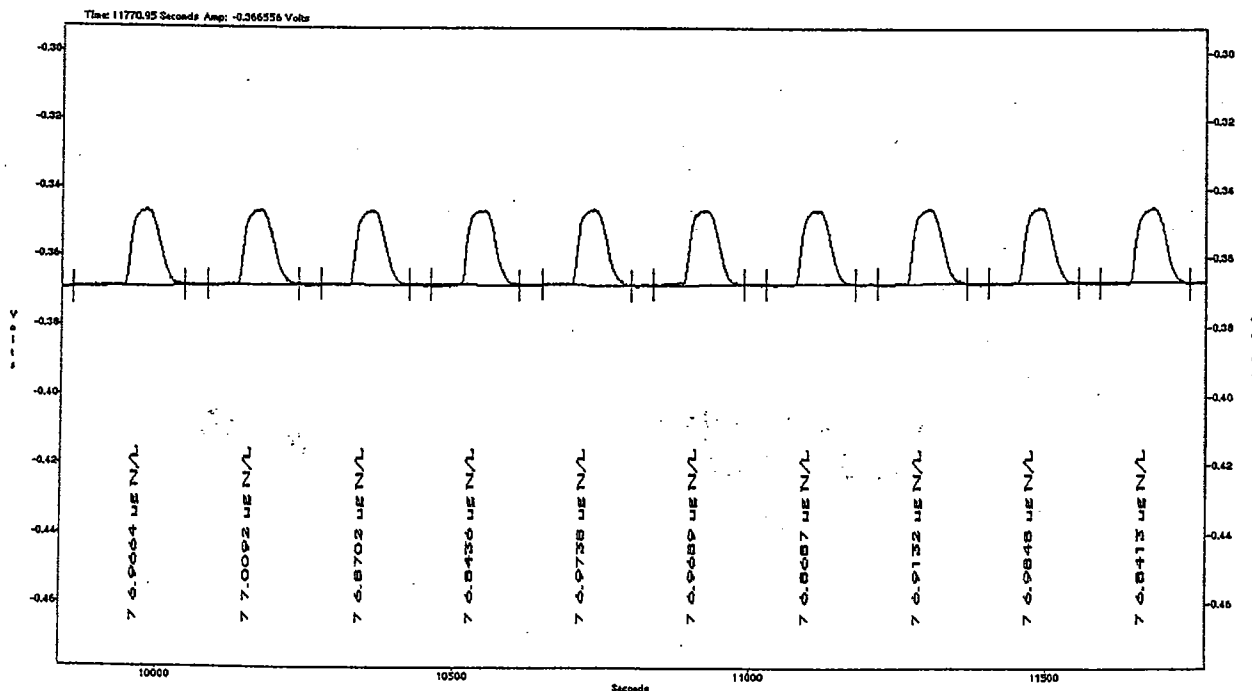

Precision data for Nitrate using 7 µg N/L standard

% RSD = 1.44

Standard Deviation (s) = 0.099 µg N/L, Mean (x) = 6.89 µg N/L, Known value = 7 µg N/L,

File Name: lno3pre3.fdt

Acq. Date: 16 November 2000

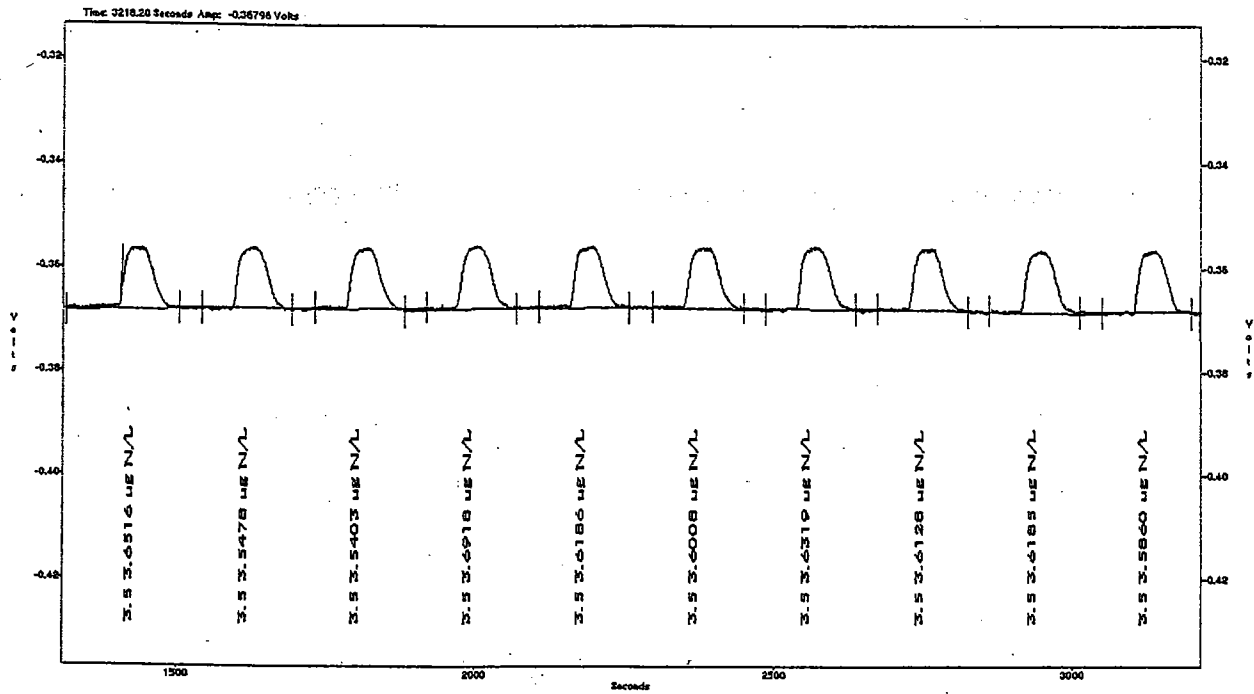

Precision data for Nitrate using 3.5 µg N/L standard

% RSD = 3.37

Standard Deviation (s) = 0.119 µg N/L, Mean (x) = 3.53 µg N/L, Known value = 3.5 µg N/L,

File Name: lno3pre3.fdt

Acq. Date: 16 November 2000

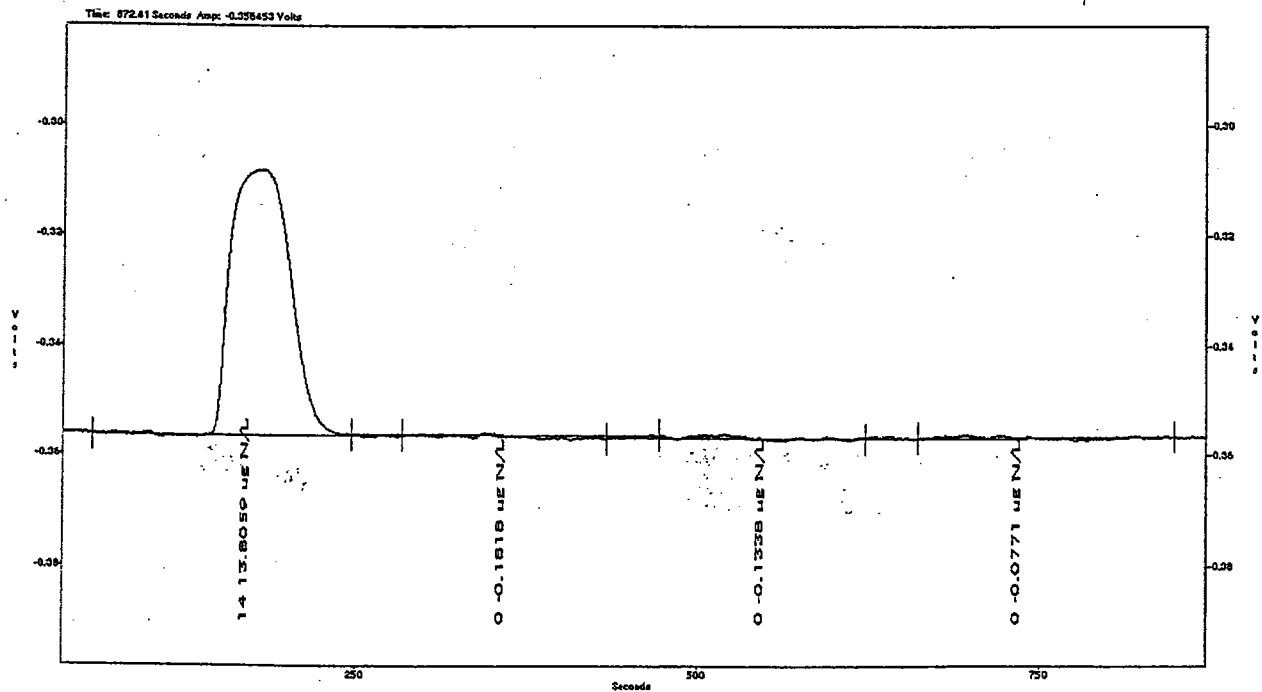

Carryover Study: 14 µg N/L standard followed by 3 blanks

Carryover Passed

File Name: lno3car3.fdt

Acq. Date: 20 November 2000

Spikes Into Artificial Seawater Matrix.

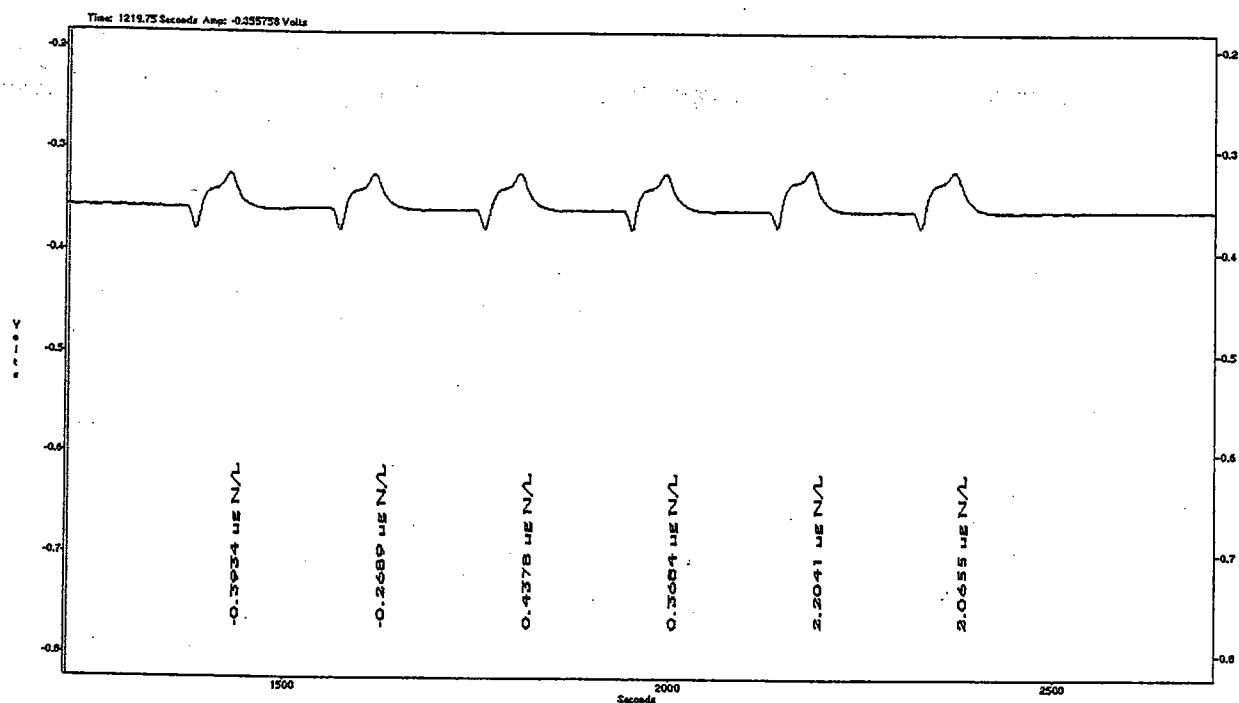

File Name: spike3.fdt
Acq. Date: 20 November 2000

0.5 and 2.1 $\mu\text{g N/L}$ as NO_3 was spiked into an artificial seawater matrix. Recoveries of 80.62% and 101.66 % were obtained, respectively. Conclusion: Recoveries of 80-120% can be obtained in the artificial matrix.

11.3. NITRATE/NITRITE MANIFOLD DIAGRAM

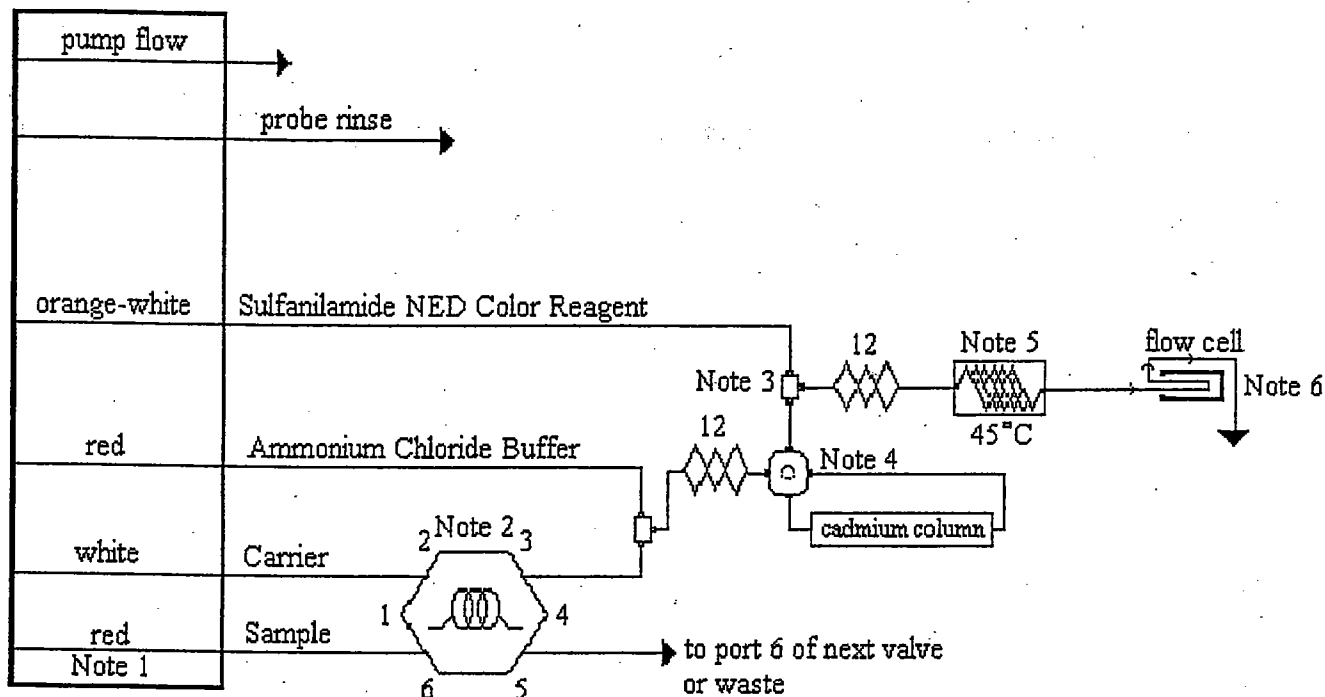

Carrier: DI water

Manifold Tubing: 0.8 mm (0.032 in) i.d. This is 5.2 $\mu\text{L}/\text{cm}$.

QC8000 Sample Loop: 125 cm x 0.042" i.d.

Interference Filter: 540 nm

Apparatus: An injection valve, a 10 mm path length flow cell, and a colorimetric detector module is required. The  shows 175 cm of tubing wrapped around the heater block at the specified temperature.

12: 150 cm of tubing on a 12 cm alternating coil support

Note: PVC PUMP TUBES MUST BE USED FOR THIS METHOD.

Note 1: Sample line is connected to a red-red pump tube

Note 2: Sample loop ends should be cut at a 30-45° angle for the best fit.

Note 3: 12 cm alternating coil support wrapped with 150 cm of 0.032" i.d. tubing.

Note 4: Two-state switching valve for the cadmium column.

Note 5: 175 cm of 0.032" tubing wrapped on the heater at 45°C. This section of tubing must not be used for phosphate or silicate chemistries, as the phosphoric acid in the nitrate color reagent can interfere in these chemistries. This section of tubing should be dedicated to nitrate only.

Note 6: Flow is to waste. Backpressure loop (50 cm x 0.022" i.d.) should be used only if outgassing is problematic, as it may cause increased noise.

Chlorophyll A
Standard Operating Procedure

Title: FLUOROMETRIC DETERMINATION OF CHLOROPHYLL A

Author: _____ Date: _____
Marie E. DeLorenzo

Program Manager: _____ Date: _____
Michael H. Fulton

Branch Chief: _____ Date: _____
Geoffrey I. Scott

1.0 OBJECTIVE

Chlorophyll *a* is used to estimate phototrophic biomass. The purpose of this method is to quantify chlorophyll *a* concentration from water samples. This method was adapted from Glover and Morris (1979).

2.0 HEALTH AND SAFETY

Personnel should wear lab coats and chemical resistant gloves.

3.0 PERSONNEL/TRAINING/RESPONSIBILITIES

Personnel should not perform this method until training by experienced individuals is complete.

4.0 REQUIRED AND RECOMMENDED MATERIALS

20 mL plastic scintillation vials
acetone
magnesium carbonate ($MgCO_3$)
deionized water
glass fiber filters (Type GF/F, 25 mm diameter)
filter apparatus
filter forceps
fluorometer (e.g. Sequoia-Turner Model 450)

disposable, borosilicate glass test tubes for fluorometer

Vortex mixer

1 and 10 mL pipettes/bulbs

5.0 PROCEDURE

5.1 Chlorophyll extraction

- Sample volume required will vary, depending on the chlorophyll concentration in the water. For PFU samples, 10 mL is typically adequate.
- Filter water sample onto glass fiber filter (Type GF/F, 25 mm diameter).
- Just before all sample passes the filter, rinse the column with two separate aliquots (1.0 mL each) deionized water. Continue vacuum until all liquid is gone.
- Release vacuum, disassemble filter tower apparatus, and remove filter with forceps.
- Place filter face up on bottom of scintillation vial, add 1 mL MgCO_3 and freeze until analysis.
- Samples should be kept in the dark for the rest of the procedure. To extract the samples, add 9 mL of acetone to each scintillation vial and shake well.
- Refrigerate samples overnight in the dark at 4 °C, shake the samples the next day, and refrigerate overnight again.
- The next day, bring the samples to room temperature and read on a fluorometer.

5.2 Fluorometric measurement

5.2.1 Chlorophyll *a*

- Before using the fluorometer for unknowns, a standard curve should be created with pure chlorophyll *a* extracts (available from Sigma).
- "Zero" each door opening of the fluorometer immediately prior to use, using a tube of 90% acetone.

Effective Date: 06 December, 2000

- Decant the chlorophyll extract from the scintillation vial into the fluorometer test tube. Care should be taken not to transfer particulates from the filter into the tube.
- Wipe off the sides of the test tube with a Kim Wipe and place the test tube in the fluorometer.
- Record the fluorescence units, door setting and gain setting.
- Samples that are too concentrated may be diluted with 90% acetone.
- A new test tube should be used for each sample.

5.2.2 Phaeo-pigments

This extra step is performed to determine and correct for the concentration of phaeo-pigments (chlorophyll degradation products) in the samples. It is usually not necessary with the GF/F filtering technique, but is provided here for those using other collection methods.

- After the first reading is taken on the fluorometer, remove the tube and add 2 drops of 5% v/v hydrochloric acid.
- Mix contents of tube with a vortex mixer.
- Take a second reading 30-60 seconds later, after a stable value is reached.

5.3 Calculations

Chlorophyll *a* (µg/mL)= (door factor*(chlorophyll fluorescence reading-phaeo-pigment reading)*gain correction*acetone volume)/volume filtered*gain.

6.0 QUALITY CONTROL/QUALITY ASSURANCE

A minimum of three replicates per site or treatment is recommended. It is important that each sample is well-mixed prior to filtration and that the samples are kept in the dark after collection onto the filters.

7.0 REFERENCES

Glover H.E. and Morris I. 1979. Photosynthetic carboxylating enzymes in marine phytoplankton. *Limnol Oceanogr* 23:510-519

Appendix B
Data Sheet/Chain of Custody

ETV multi-parameter water probe chain of custody form

Proj. No. G003383 33mult	Project Title: multi-parameter water probe verification	ANALYSIS REQUESTED (CHECK BOXES)										Number of Containers	Remarks
SAMPLERS: (Signature)		Turbidity	Chlorophyll A	Nitrate	Phosphate							Container No	
		DATE	TIME	SAMPLE I.D.									
Relinquished by: (Signature)		Date/Time		Received by: (Signature)								Date/Time	
													Page ____ of ____

Site Notes:

Circle One

- Site: Kiawah Mesocosm Harbor
- Wind: Calm Slight Breeze Moderate Breeze Windy
- Wind Direction: N NE E SE S SW W NW
- Weather: Clear Partly Cloudy Overcast Rain Drizzle Fog Snow
- Tidal Stage Flooding Ebb High
- Water Surface Calm Ripples Chops Swells

Air Temperature _____

Other Notes: _____