

US EPA ARCHIVE DOCUMENT

Model Development for Simulation of Dry - Weather Metals Loading from the San Gabriel River Watershed

November 2005

Prepared for:
USEPA Region 9
Los Angeles Regional Water Quality Control Board

Prepared by:
Tetra Tech, Inc.

1. Introduction

The State of California is required to develop Total Maximum Daily Loads (TMDLs) for waters not meeting water quality standards, in accordance with Section 303(d) of the Clean Water Act and the U. S. Environmental Protection Agency (EPA) Water Quality Planning and Management Regulations (40 CFR Part 130). Several segments of the San Gabriel River and its tributaries were included on the State Water Resources Control Board’s 303(d) list of impaired waters in California for a variety of pollutants. Specifically, the San Gabriel River system was included for impairment of the metals copper, lead, and zinc.

A system of models was developed to support the establishment of TMDLs for the metals impairments within the San Gabriel River and its tributaries. This report outlines the assumptions used in the model development and application. These models were developed to assess instream concentrations and sources of copper, lead, and zinc in low-flow conditions. The work presented herein was performed in cooperation with EPA Region 9, the Southern California Coastal Water Research Project (SCCWRP), the Los Angeles Regional Water Quality Control Board (LARWQCB), the City of Los Angeles, the Los Angeles County Department of Public Works (LACDPW), the Los Angeles County Sanitation District (LACSD), and the Los Angeles and San Gabriel Rivers Watershed Council.

The San Gabriel River flows from the San Gabriel Mountains at the northern end of the City of Los Angeles to the Pacific Ocean. The headwaters of the San Gabriel River are located in the San Gabriel Mountains, and the flow is controlled by the San Gabriel and Morris Reservoirs before draining through the urban areas of Los Angeles. The San Gabriel River flows south through a heavily developed commercial and industrial area and drains into the Pacific Ocean at Long Beach Harbor. Major tributaries to the river are Coyote Creek, San Jose Creek, and Walnut Creek. Due to major flood events at the beginning of the century, most of San Gabriel River was lined with concrete by the 1950s. Figure 1 shows the San Gabriel River watershed in relation to neighboring counties and the State of California. Figure 2 shows the predominant landuses in the drainage area..

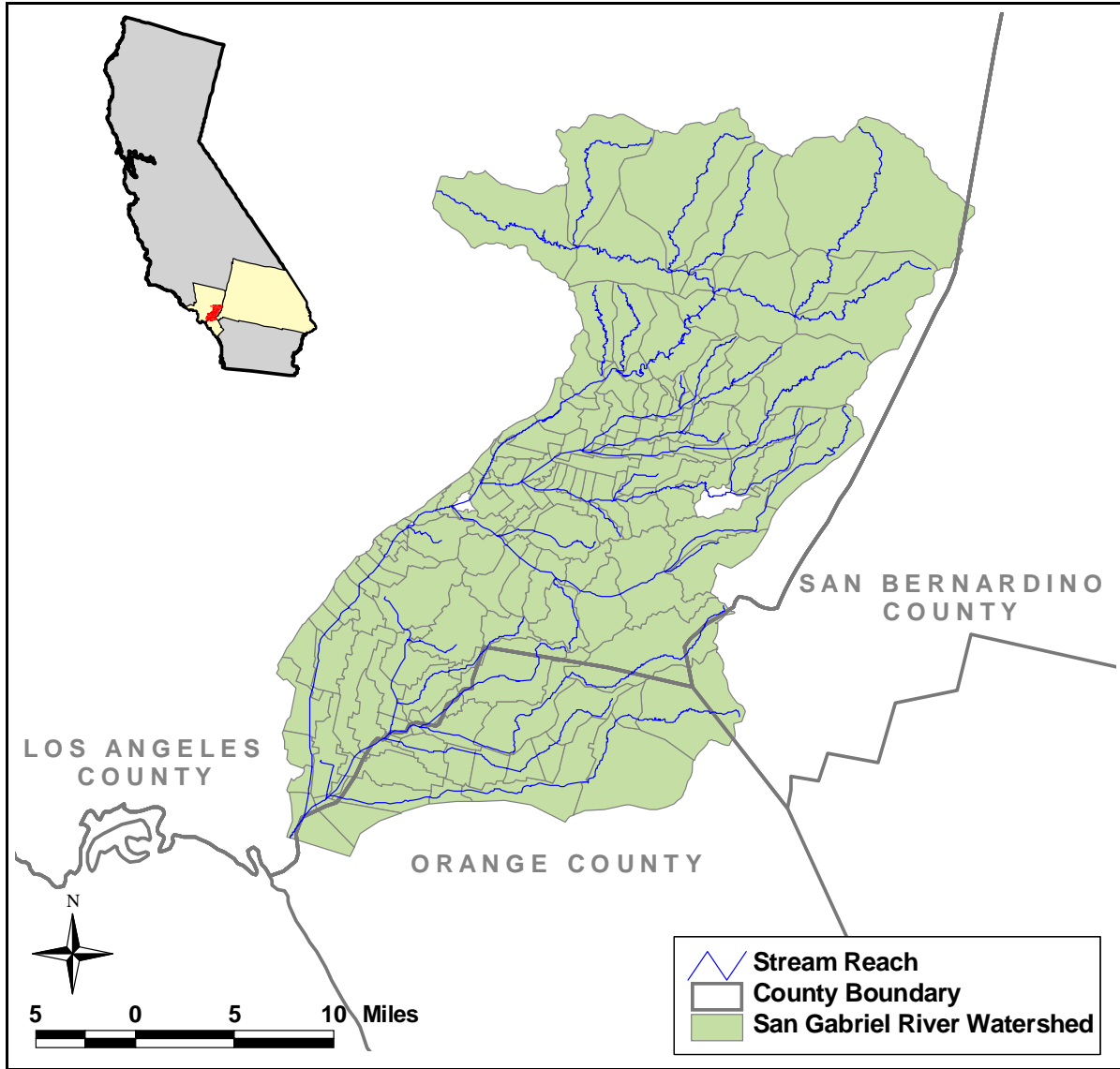

Figure 1. San Gabriel River Basin

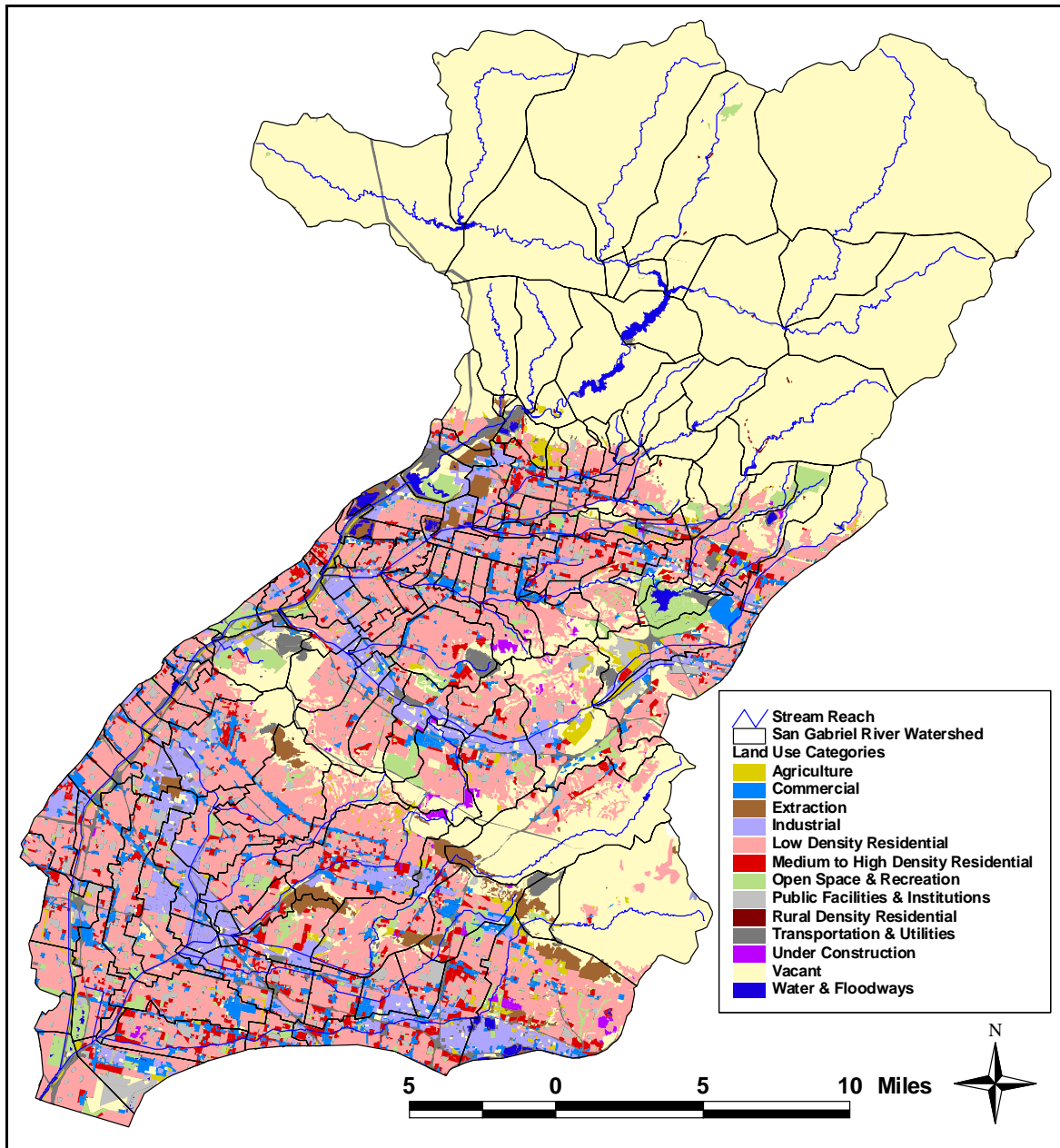

Figure 2. Landuse Distribution in the San Gabriel River Watershed

The San Gabriel River has two distinct flow conditions as a result of the prevailing rainfall patterns in the region. Typically the high-flow (or wet weather) conditions occur between October and March, while the low-flow (or dry weather) conditions occur from April through September. The wet-weather periods are marked by events when flows in the river and tributaries rise and fall rapidly, reaching flow levels on the order of thousands of cubic feet per second (cfs). Flows during the wet-weather periods are generated by storm runoff in the watershed. Stormwater runoff in the sewered urban areas of the watershed is carried to the river through a system of stormdrains.

In between rainfall events and during low-flow periods, the flows are significantly lower and less variable. Flows during these periods are provided by point source discharges, urban runoff, and groundwater baseflow. The predominant contribution to dry-weather instream flow comes from the point source discharges. The predominant contribution of metals varies from point and non-point sources depending on the conditions.

During dry weather, various controls and features in the watershed impede or divert flows at various locations. During low-flow conditions, flows from tributaries such as Coyote Creek, San Jose Creek, and Walnut Creek are separated from San Gabriel River and each behaves as an independent system. The Rio Hondo hydraulically connects the San Gabriel River to the Los Angeles (LA) River watershed through the Whittier Narrows Reservoir. Flows from the San Gabriel River and Rio Hondo merge at this reservoir during larger flood events, and flows from the San Gabriel River watershed may impact the LA River. Most of the water in the Rio Hondo is used for groundwater recharge during dry weather.

2. Dry-weather Modeling Approach

When selecting an appropriate technical approach for a water quality modeling study, it is important to identify and understand the defining characteristics of the waterbody system, the goals and planned uses of the modeling system, and any unique aspects of the waterbody or impairment that will guide the approach. A technical committee comprised of representatives from various agencies coordinated the selection of an appropriate modeling approach for addressing the metals impairments in the San Gabriel River and tributaries, as well as supporting monitoring. This committee included representatives from EPA Region 9, the LARWQCB, SCCWRP, the City of Los Angeles, LACDPW, LACSD, and the Los Angeles and San Gabriel Rivers Watershed Council.

Specific criteria were used in selection of an appropriate modeling system of the watershed. For instance, the selected models should be capable of simulating the hydrology and the water quality of the river system and should be capable of addressing the influential characteristics or aspects of the watershed and waterbody system (e.g., nonpoint and point source inputs, low flows, etc.). Since separate models are often used for simulation of hydrodynamics and water quality, the models should also be easily linked to improve transferability between model users and streamline the technical review process.

The modeling criteria and were evaluated against available models and recent applications of models for TMDL development (e.g., models developed for LA River to support metals TMDL development). Model selection also considered public access to model software, model distribution and support, and acceptance by EPA in similar TMDL applications. Based on the review, a suite of models requiring minimal modifications were selected for the San Gabriel River application.

The selected modeling system consisted of a hydrodynamic model linked with a separate water quality model of the river system. For simulation of hydrodynamics, the one-dimensional (1-D) version of the Environmental Fluid Dynamics Code (EFDC) was used. This model was linked to

the Water Quality Analysis Simulation Program (WASP) for simulation of pollutant transport. These models, both in the public domain and with a track record of TMDL applications, were mostly consistent with model selection criteria and sufficient for simulation of the unique low-flow conditions of the river system. The WASP model was modified slightly to provide simulation of multiple individual point sources. The following sections describe in more detail the models selected for application to the San Gabriel River system, including why the models are the most appropriate for the analysis. Supplemental monitoring needs for application of the selected models were also identified.

2.1 Hydrodynamic Model – EFDC

EFDC (Hamrick, 1992 and 1996) is a modeling package for simulating one- or multi-dimensional flow, transport, and bio-geochemical processes in surface water systems including rivers, lakes, estuaries, reservoirs, wetlands, and coastal regions. The model is supported by USEPA and has been used extensively to support TMDL development throughout the country. Special enhancements to the hydrodynamic portion of the code, including hydraulic structure representation, allow refined modeling of especially controlled systems such as San Gabriel. The EFDC model has been extensively tested, documented, and applied to environmental studies worldwide by universities, governmental agencies, and environmental consulting firms, and is considered public domain software.

The 1-D version of EFDC was used to simulate hydrodynamics in San Gabriel River and its tributaries. This model was appropriate for use in the San Gabriel River analysis because the evaluation focused on longitudinal changes in water quality conditions and data were not available to support use of the 2-D or 3-D versions of the model.

In EFDC, a 1-D variable cross-section sub-model solves the 1-D continuity, momentum, and transport equations within a variable cross-section framework. The 1-D sub-model uses the efficient numerical solution routines within the more general 2-D/3-D EFDC hydrodynamic model as well as the transport and meteorological forcing functions. Specific details on the model equations, solution techniques and assumptions can be found in Hamrick (1996).

The use of variable cross-sections in EFDC makes it possible to use detailed data available for the river channels to better define the channels and provide finer distinctions among channel segments, including areas of concrete channels. Because of the variable cross-section features, EFDC has the ability to account for the spreading grounds and the low-flow channels in the river system. The ability to incorporate the spreading grounds in the system is important for the application of the model for potential use in simulating wet-weather conditions in the future.

2.2 Water Quality Model – WASP5

EPA's Water Quality Analysis Simulation Program (WASP5) is an enhancement of the original WASP model (Di Toro et al., 1983; Connolly and Winfield, 1984; Ambrose, R.B. et al., 1988), which is a dynamic compartment model program for assessing aquatic systems, including both

the water column and the underlying benthos. The time-varying processes of advection, dispersion, point and diffuse mass loading, and boundary exchange are represented in the basic program. Water quality processes are represented in special kinetic subroutines that are either chosen from a library or written by the user. WASP5 is structured to permit easy substitution of kinetic subroutines into the overall package to form problem-specific models. WASP5 permits the modeler to structure one, two, and three-dimensional models, allows the specification of time-variable exchange coefficients, advective flows, waste loads and water quality boundary conditions, and permits tailored structuring of the kinetic processes, all within the larger modeling framework without having to write or rewrite large sections of computer code.

WASP5 was chosen for use in the modeling analysis of San Gabriel River because it can simulate all of the parameters of concern and it is easily linked with EFDC output. WASP5 also allowed for the simulation of metals as either a conservative substance (meaning no loss of mass) or with a first-order decay coefficient. For the San Gabriel River application, metals were modeled as a conservative substance. This is an appropriate assumption for this system since metals occur mostly in the dissolved phase in the water column during dry conditions, reducing opportunity for instream losses (e.g., settling processes associated with particulate material).

To accurately address the unique conditions in the San Gabriel River, the original WASP5 computer code was modified to allow input of more than one load into a single segment. The original WASP5 code limits the user to input only one load into any one segment. To input more than one load into a segment, these loads would be added together and the single combined load would have been used as input into the model. For most modeling applications this is sufficient. However, for the San Gabriel River, WASP5 was modified to input the loads separately, providing an efficient way to clearly identify and track each load input into the model.

2.3 Supplemental Monitoring

This modeling study focuses on the critical low-flow period for metals loading to the San Gabriel River system. To characterize the sources influencing flow and water quality in the river system, SCCWRP (2004) conducted intensive monitoring in the watershed during periods representative of typical low-flow conditions. The first monitoring event was conducted on September 29 and 30, 2002, and the second was conducted on September 14 through 16, 2003. The datasets collected represent snapshots of the flow distribution and water quality conditions throughout the San Gabriel River system.

During the measurement periods in September 2002 and September 2003, all observed sources of flow to the San Gabriel River system were from either point sources or stormdrains. The point source contributions came from five wastewater reclamation plants (WWRPs) – Los Coyotes, Long Beach, San Jose East, San Jose West, and Pomona. Flow and water quality data were also collected for identified dry-weather stormdrain flows and used as model input to represent the dry-weather loadings to the river system. Nearly 80% of flows to the San Gabriel River system during the sampling periods were from WWRPs (SCCWRP, 2004).

In addition to data used as input to the model, SCCWRP collected instream velocity data to support model development. During the summer of 2002, SCCWRP performed dye studies in the San Gabriel River, Coyote Creek, and San Jose Creek to estimate velocities. However, due to the variability of flows in the system, and the limited data representative of velocities during periods with corresponding information regarding inflows (such as provided by SCCWRP [2004] in the intensive dry-weather monitoring), use of these data for hydrodynamic calibration was not possible. Rather, the velocity data obtained from the dye study were useful for verification that simulated velocities were reasonable.

The hydrodynamic and water quality model simulations, based on inflow data from the monitoring studies, represent snapshots of dry-weather conditions of the river system in September of 2002 and 2003. The resulting simulated water quality results were compared with the instream water quality measurements. For all of the SCCWRP (2004) monitoring stations, triplicate composite samples were collected at each location to provide a measure of the system variability for water quality calibration. Total copper, total lead, and total zinc concentrations were simulated in the WASP5 water quality model and compared to the observed ranges of water quality at corresponding locations in the river system.

3. Model Development

The following subsections describe the model set-up for the San Gabriel River system, including model linkages, simulation period, model boundaries, and model input parameters.

3.1 Model Linkages

The 1-D EFDC model was utilized to simulate the flow and transport of metals within the river system under dry-weather conditions. Metals were simulated as a conservative substance (zero instream losses) using the WASP5 model system. The EFDC model was externally linked to the WASP5 model through a hydrodynamic forcing file that contains the flows, volumes, and exchange coefficients between adjacent cells. The EFDC model utilizes the user-defined flow inputs (e.g., point source discharges, dry-weather stormdrain discharges, etc.) and develops instream flows and transport that are transferred to the WASP5 model through a hydrodynamic linkage file. The WASP5 water quality model then runs at a similar time step with a consistent grid network configuration. Model setup of the river system included the following reaches:

- San Gabriel River
- Coyote Creek
- San Jose Creek
- Walnut Creek

During low-flow conditions, these reaches are not linked. Therefore, models of these river reaches were independent of each other for the dry-weather simulation periods.

3.2 Simulation Period

Selection of the model simulation periods was based on the dry-weather, low-flow condition. Monitoring studies performed by SCCWRP (2004) on two separate periods were assumed representative of these conditions. These surveys were performed on September 29 and 30, 2002, and September 14 to 16, 2003. The hydrodynamic and water quality models were configured for simulation of each of these periods.

3.3 Model Setup and Inputs

The following describes data that were used in the model setup and the inputs used in the 2002 and 2003 simulations for low-flow conditions. These include the following hydrodynamic (EFDC) and water quality (WASP5) inputs:

- Geometry
- Topography
- Meteorological data
- Source data

3.3.1 Geometry

All of the waterways modeled were concrete lined. The major waterways in the watershed were planned and constructed in the early part of the twentieth century. Over time, modifications have been made to the waterways such as adding low-flow channel sections, repairing deteriorated portions, and other various as-needed work. As a result of the size of the watershed conduit system and time period for the majority of the construction, there was not a readily discernible location for complete and current geometric information on the major waterways. However, detailed geometry data were needed to physically define the river system in the models to appropriately simulate flow and transport under low-flow conditions.

The model of the river reaches was established with a variable cross-section grid. The San Gabriel River was represented using 26 grid cells, the Coyote Creek was represented using 22 grid cells, the San Jose Creek was represented using 42 grid cells, and the Walnut Creek was represented using 18 grid cells. All grid cells were 804.7 meters (0.5 miles) in length. The geometric model input files for each cross-section were established based on the following user-defined information:

- Invert elevation
- A range of depths measured above the invert, covering the full depth of the cross-section
- Cross-sectional area associated with each depth above the invert
- Wetted perimeter associated with each depth above the invert
- Top width associated with each depth above the invert

The geometric input files represent the full cross-section of the river, including the low-flow channel. The EFDC model is then capable of simulating the full range of flow conditions that do not overtop the existing channel.

Invert elevation and cross sectional geometry for the waterways in this study were determined from review of construction plans and as-built drawings, typical section sheets from the LACDA USACE O&M Manual, FEMA flood study HEC-2 decks, photographs, and limited field reconnaissance. Figures 3 through 6 show typical cross-sections of each of the reaches. Cross-sections for each grid cell were assumed constant until alternate downstream sections were identified and defined based on as-built drawings or other sources.

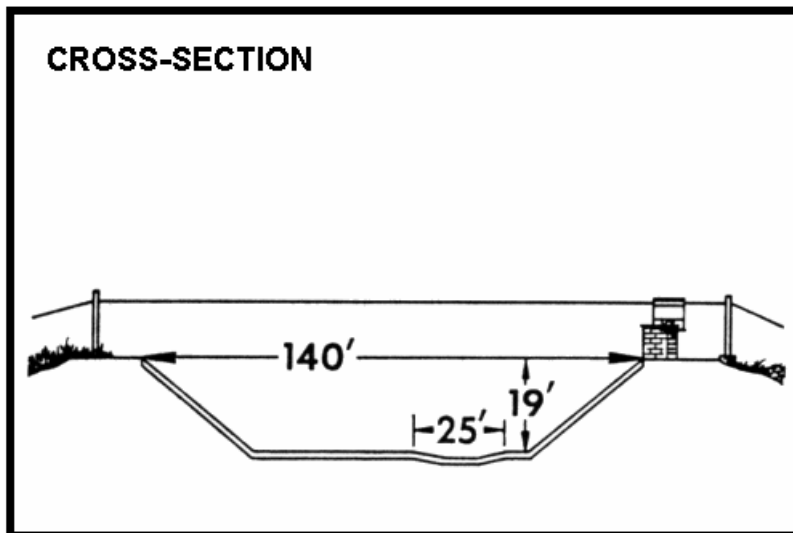

Figure 3. Typical Channel Cross-Section for San Gabriel River

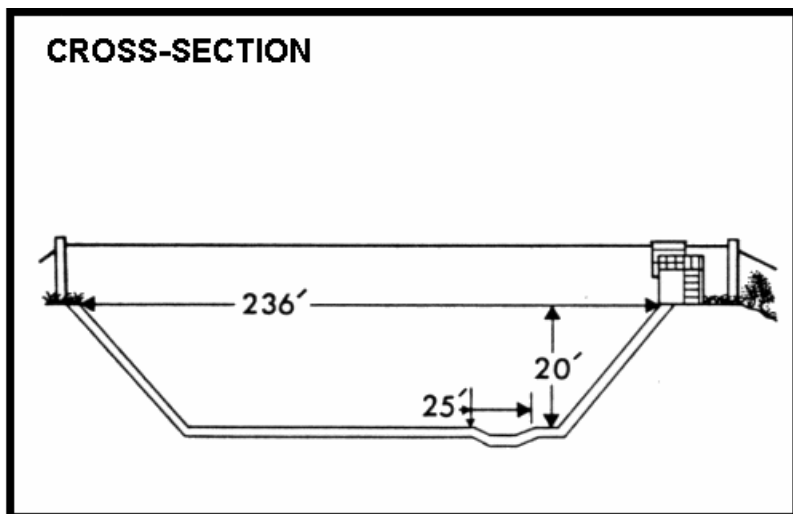

Figure 4. Typical Channel Cross-Section for Coyote Creek

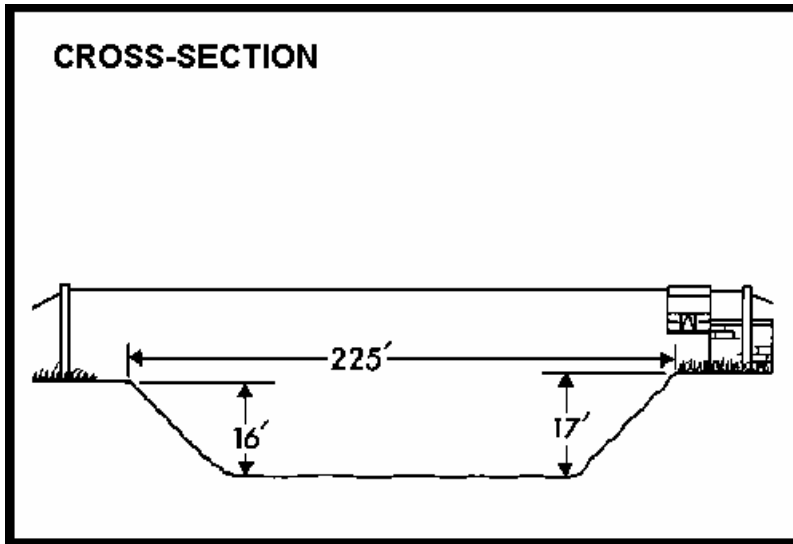

Figure 5. Typical Channel Cross-Section for San Jose River

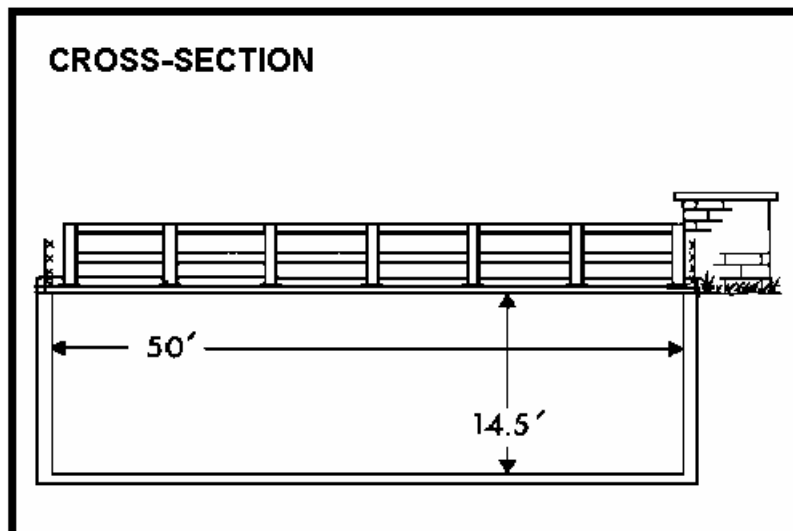

Figure 6. Typical Channel Cross-Section for Walnut Creek

3.3.2 Topography

Topographic data used in the model simulations were obtained from the USGS Digital Elevation Model (DEM) within the BASINS database with a resolution of 90 x 90 feet. Figure 7 presents the DEM data used in the model simulations. Within the river model network, the DEM provided invert elevations and slopes for the channel sections where data were not available from the as built drawings.

3.3.3 *Meteorological Data*

Relevant meteorological parameters necessary for input into EFDC and WASP models are:

- Air Temperature
- Relative Humidity
- Wind Speed
- Wind Direction
- Solar Radiation
- Cloud Cover

The primary weather station located at Long Beach provided the meteorological data used in the simulation of temperature in the EFDC hydrodynamic model. Given the type of data, a single station was sufficient because spatial variability is not as critical for these parameters as it is for rainfall. Because the modeling evaluates dry-weather conditions with no rain-driven inputs, precipitation data are not a necessary input for low-flow modeling. However, all meteorological data were input to the models for completeness.

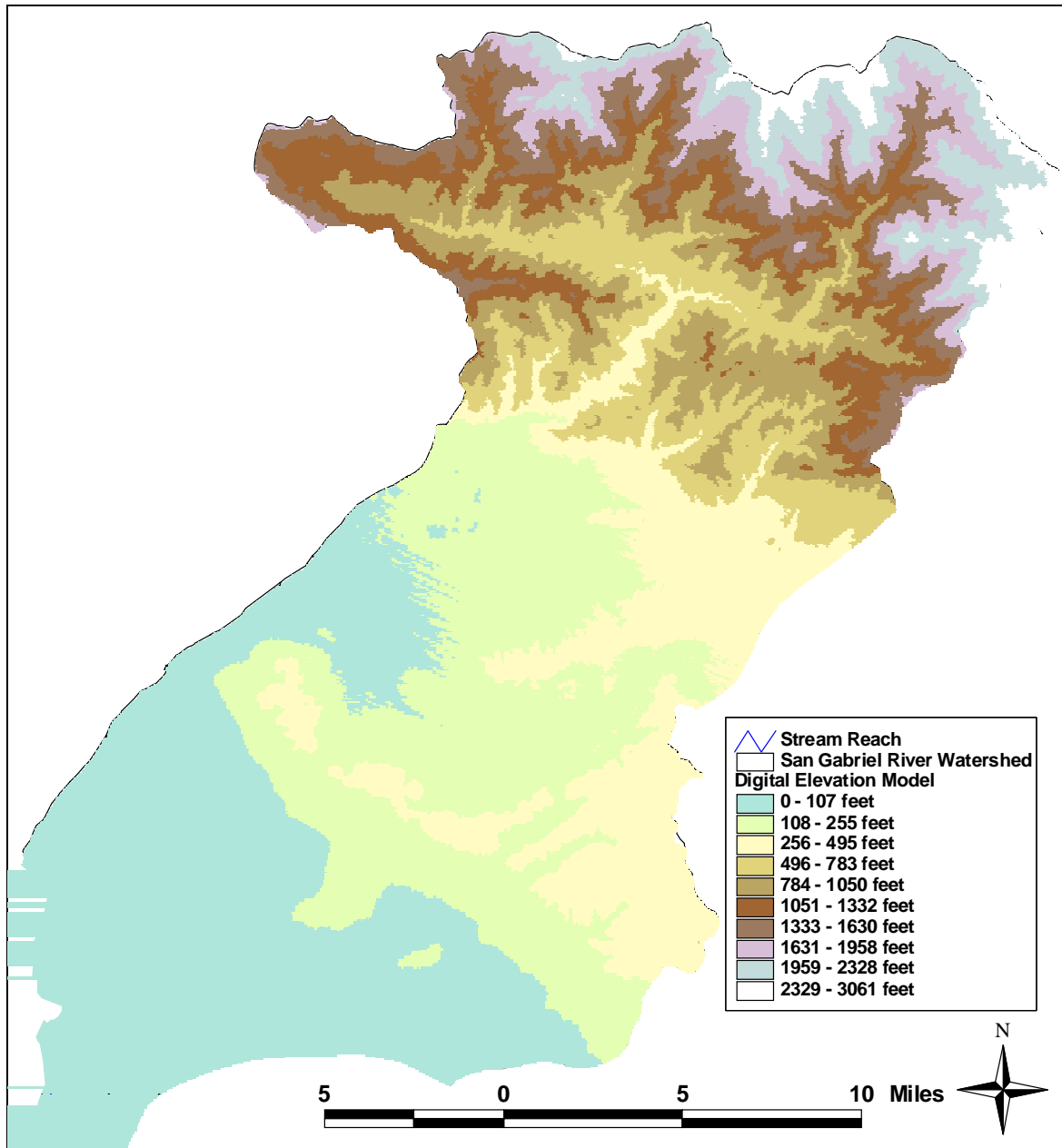

Figure 7. Topography in the San Gabriel River Watershed

3.3.4 Source Representation

For this application, SCCWRP (2004) conducted targeted monitoring throughout the watershed in September 2002 and September 2003 to better characterize sources of flow and metals to the river system. Examination of these data indicated that during these low-flow periods, all sources of flow and loading came from either point source discharges or inflows from stormdrains.

During the low-flow measurement periods, there were five active point source flows measured. The Los Coyotes WWRP contributed flow to the San Gabriel River (San Jose WWRP #1 did not discharge during both monitoring periods). The Long Beach WWRP contributed flow to Coyote Creek. The San Jose WWRP #2 (West), San Jose WWRP #3 (East), and the Pomona WWRP contributed flow to San Jose Creek. All other flows measured during the low-flow measurement periods were assumed to result from stormdrain inflows.

For each of the hydrodynamic simulation periods, it was necessary to characterize the sources of flow as closely as possible to properly represent river flows. All flows recorded during each simulation period were input in the model as constant daily averages. Table 1 presents the WWRP flows used in the model setup for September 2002 and September 2003.

Table 1. Flow Data from the Five Major Point Source Discharges Used in Model Setup

Point Source Discharge	Flows used for September 29-30, 2002 ¹		Flows used for September 14-16, 2003 ¹		Receiving Stream
	Flow (cms)	Flow (mgd)	Flow (cms)	Flow (mgd)	
Los Coyotes WWRP	1.498	34.19	0.770	17.58	San Gabriel River
Long Beach WWRP	0.476	10.86	0.374	8.53	Coyote Creek
San Jose WWRP #1	0	0	0	0	San Gabriel River
San Jose WWRP #3 (East)	1.453	33.16	1.294	29.54	San Jose Creek
San Jose WWRP #2 (West)	2.248	51.32	1.300	29.67	San Jose Creek
Pomona WWRP	0.428	9.76	0.433	9.89	San Jose Creek

¹Based on discharge monitoring data provided by the WWRP

The other major sources of flows to river system are dry-weather stormdrain discharges. During the September 29-30, 2002 monitoring, 67 active dry-weather stormwater flows were identified in the watershed. Of these active stormdrains, 14 were located on the San Gabriel River, 18 on Coyote Creek, 28 on San Jose Creek, and 7 on Walnut Creek. During the September 14-16, 2003 monitoring, 73 active dry-weather stormwater flows were identified. Of these, 10 were located on San Gabriel River, 16 were located on Coyote Creek, 33 were located on San Jose Creek, and 14 were located on Walnut Creek. These observed stormdrain flow and water quality concentrations are summarized in Table A-1 of Appendix A.

To provide sufficient depth of flow for model stability, a minimum flow is required for model simulation. In some cases, the flows measured at the headwaters did not provide the minimum flow required to prevent model instability. For this reason, the farthest upstream flows measured during the monitoring periods were combined until a sufficient level of model stability was achieved. The resulting sum of flows was used to characterize headwater flows, or flows assumed at the upstream extent of the model domain. For the San Gabriel River, Coyote Creek,

and San Jose Creek, this required inclusion of flows from WWRPs to provide the necessary minimum headwater flows. For San Jose Creek, the furthest downstream WWRP flows added to headwater assumptions were those for Pomona. The model domain did not extend much further upstream than this discharge, so the assumption of adding these flows to the headwaters was not far from reality. However, due to the low flows observed in San Gabriel River and Coyote Creek, flows from Los Coyotes WWRP and Long Beach WWRP were added their headwater flows, respectively, to prevent model instability. Since these WWRPs are located at lower sections of the reaches, these flow assumptions required adjustment of associated inflow water quality concentrations so that prediction of metals concentrations in San Gabriel River and Coyote Creek were not impacted. These adjustments are discussed later in this section. Table 2 presents the flows assumed in the model at the headwater of each reach and which WWRP and stormdrain flows were combined to determine these values. These flows were input to the uppermost model cell of each reach.

Table 2. Measured Headwater Inflows Used for Model Setup

Location	Flows Used for September 29-30, 2002 (cms)	Measured Sources of Flow (Sept 2002) ¹	Flows Used for September 14-16, 2003 (cms)	Measured Sources of Flow (Sept 2003) ¹
San Gabriel River	1.511	11-01, 10-01, 11-02, 10-03, 10-04, 12-02, Los Coyotes WWRP	0.777	110-03, 110-02, 110-01, 112-01, Los Coyotes WWRP
Coyote Creek	0.057	Brea	0.208	Brea-A, 135-04, 134-01
San Jose Creek	0.468	09-01, 09-05, 09-04, 09-03, 08-02, 08-01, Pomona WWRP	0.462	101-01, 101-02, 101-03, 101-04, 101-05, 101-07, Pomona WWRP
Walnut Creek	0.020	02-01, 01-04, 02-02	0.026	109-02, 109-04, 109-01

¹Stormdrains identified by number (e.g. 11-01, 110-03) are listed in Appendix A. WWRP flows are listed in Table 1.

Table 3 presents a summary of the model representation of water quality inputs from sources of metals to the river system—WWRP and stormwater concentrations. Following is a discussion of the data used to characterize the inputs for the WASP water quality comparisons.

Table 3. Summary of Water Quality Representation of Sources in the San Gabriel River System

Source Inflows	Representation in 1 st Comparison	Representation in 2 nd Comparison
WWRP	Metals concentrations based on measurements of WWRP effluent on September 29-30, 2002	Metals concentrations based on measurements of WWRP effluent on September 14-16, 2003
Dry-weather stormdrain flows	Metals concentrations based on water quality measurements in 67 active stormwater flows on September 29-30, 2002	Metals concentrations based on water quality measurements in 73 active stormwater flows on September 14-16, 2003

During the 2002 and 2003 data collections, many water quality samples were measured as “non-detects” or “less than detection limits”. This means that when analyzing the sample, the true concentration was below the detection limits of the test being performed. Each sample measured as a non-detect value was initially input into the model at half the detection limit of each metal. This resulted in some unusual longitudinal concentration results (artificially higher than observed

values). Afterward, readings that were less than the detection limits were entered as a value of zero (0) to determine the sensitivity of the results to this assumption. In the summary tables presented here, measurements below the detection limit are indicated. For example, a value below a minimum detection limit of 0.003 mg/L is indicated as “<0.003”. Results of model simulations with assumptions for “non-detects” and “less than detection limits” at half the detection limit and at zero are reported in Section 4.

The WWRPs in the watershed routinely monitor their discharge effluent. Corresponding water quality data for the major WWRPs collected during the SCCWRP (2003) monitoring periods were used for model input. Table 4 presents the water quality data used to represent WWRP discharges in the model.

Table 4. Water Quality Characteristics of WWRP Inputs for Model Comparisons (UG/L)

Point Source Discharge ³	Copper (ug/L)		Lead (ug/L)		Zinc (ug/L)	
	Com ¹	Com ²	Com ¹	Com ¹	Com ²	Com ¹
Los Coyotes WWRP	<8	<3	<0.4	<8	<3	<0.4
Long Beach WWRP	<8	<3	<0.4	<8	<3	<0.4
San Jose WWRP #3 (East)	<8	<3	<0.4	<8	<3	<0.4
San Jose WWRP #2 (West)	<8	<3	<0.4	<8	<3	<0.4
Pomona WWRP	<8	<3	<0.4	<8	<3	<0.4

¹ Based on data collected on September 29-30, 2002

² Based on data collected on September 14-16, 2003

³ San Jose WWRP #1 did not discharge to San Gabriel River during sampling periods

SCCWRP (2003) measured flow and water quality at 67 dry-weather stormdrain discharges to the river system during the September 2002 monitoring and at 73 discharges during the September 2003 monitoring. The data collected by SCCWRP were used to assign representative flow and metals concentrations to each of the individual runoff discharges, characterized as inputs to the model cells corresponding to their measurement location. The flows and metals concentrations at the stormdrains are summarized in Table A-1 of Appendix A.

For each of the headwater flows previously described in Table 2, a water quality concentration was determined. Assumptions for headwater metals loadings were based on composite water quality samples collected by SCCWRP (2003) at each upstream reach model boundary during each monitoring period. Table 5 presents the observed headwater water quality concentrations measured by SCCWRP. A simple mass balance calculation was performed to adjust headwater concentrations to accurately account for mass loads to the system, which were dependent on flows adjusted to prevent model instability (Table 2).

Table 5. Water Quality Concentrations of Headwaters in Model Setup (UG/L)

Tributary	Copper (ug/L) ¹		Lead (ug/L) ¹		Zinc (ug/L) ¹	
	Com ²	Com ³	Com ²	Com ²	Com ³	Com ²
San Gabriel River	4.6	3.2	0.26	4.6	3.2	0.26
Coyote Creek	<8	<3	<0.4	<8	<3	<0.4
San Jose Creek	10.7	2.33	0.53	10.7	2.33	0.53
Walnut Creek	10.3	12.8	1.5	10.3	12.8	1.5

¹ Based on data collected on September 29-30, 2002

² Based on data collected on September 14-16, 2003

4. Model Results

WASP5 water quality model results were compared to observed data, with no modification of modeling parameters to improve comparison. Lack of water quality calibration and validation was due to limited supporting data and the simulation of metals as conservative substances with no losses or decay. As conservative substances, processes affecting water quality are limited to dilution and transport, which depend on results of the hydrodynamic model. The hydrodynamic model is further constrained by the accuracy of inflows represented by field measurements. Boundaries of the WASP5 water quality model were also defined by measured water quality data. The WASP5 model was used to simulate both monitored periods (September 29 and 30, 2002, and September 14 through 16, 2003) under steady-state conditions with constant loads and forcing functions. For each metal, comparison was considered successful if magnitudes and trends in simulated data were reflected in the observed data. Metals concentrations below the detection limit were represented at half the detection limit. Afterward, a sensitivity analysis was performed in which these concentrations were represented with a value of zero (0). For comparison of model results with observed instream water quality, non-detectable levels of metals within the stream channels were assumed to maintain consistent assumptions with inflow non-detects for the respective model scenarios.

4.1 Model Simulations of Copper

Model results for copper within each reach are discussed in the following sections. For each reach, results are shown for both monitoring periods and assumptions for water quality non-detects for inflows (zero and half the detection limit).

4.1.1 San Gabriel River Copper Simulation

The water quality comparisons for copper for the San Gabriel River for the two monitoring periods and assumptions for water quality non-detects are shown in Figures 8 through 11. The comparison points for the San Gabriel River consisted of four composite samples collected along the river during both the September 2002 and 2003 monitoring periods.

Observed copper concentrations in the San Gabriel River are highly variable, with ranges sometimes varying by orders of magnitude for both monitoring periods. However, most of the measured copper levels in the river were at non-detectable levels in September 2003. Based on measured inflows used to represent model inputs, the simulated copper levels within the river were either below or close to the lower levels of the observed ranges. This was impacted by the Los Coyotes WWRP discharge, which had non-detectable copper levels (Table 4) and was therefore represented with assumptions for non-detects. As a result, model results show a noticeable relative impact of assumptions for non-detects on instream water quality simulations. The net result of changing from half the detection limit to zero for non-detects at inflows to the river is lower simulated copper levels in the river.

4.1.2 Coyote Creek Copper Simulation

The water quality comparisons for copper in Coyote Creek for the two monitoring periods and assumptions for water quality non-detects are shown in Figures 12 through 15. The comparison points for Coyote Creek consisted of three composite samples collected along the river during the September 2002 monitoring period, and five composite samples collected during the September 2003 period.

As with the San Gabriel River, observed ranges of copper concentrations in Coyote Creek vary by orders of magnitude, and differ between monitoring periods. Model-simulated instream copper levels are heavily controlled by assumptions for inflows. As a result, assumptions for non-detects at these inflows have a noticeable impact on simulated copper levels in the creek.

4.1.3 San Jose Creek Copper Simulation

The water quality comparisons for copper for San Jose Creek for the two monitoring periods and assumptions for water quality non-detects are shown in Figures 16 through 19. Four composite samples were taken on San Jose Creek on September 30, 2002, however, one of these locations was located upstream of the simulated portion of the reach. Likewise, two of the eight composite samples collected during the September 15, 2003, period were upstream of the model domain. As was previously discussed, the upstream flows were combined and applied at approximately River Mile 15.0 to provide more consistent flow, depth, and model stability. Therefore, the comparison points for San Jose Creek consisted of three composite samples collected along the river on September 30, 2002, and six samples collected on September 15, 2003.

WWRP discharges heavily control instream flows and associated copper levels in San Jose Creek. However, copper levels from WWRPs are based on assumptions for non-detects (Table 4), which were simulated based on levels assumed at half the detection limit (4 ug/L) and zero. If flows were based only on WWRP flows, all instream concentrations would be at assumed values for non-detects. However, simulated instream concentrations vary longitudinally, indicating the influence of inflows from stormdrain discharges on model results. For the September 2003 model scenario, it is clear that assumed copper loads for these stormdrain discharges did not result in model-simulated instream concentrations that were comparable to

observed non-detectable levels within the creek channel. This anomaly may be due to additional influencing factors that were not accounted for in the model, or misrepresentation of loads from stormdrains based on the measured flows and copper concentrations. Assumptions for non-detects had noticeable impact on model results for copper in San Jose Creek.

4.1.4 Walnut Creek Copper Simulation

The water quality comparisons for copper for Walnut Creek for the two monitoring periods and assumptions for water quality non-detects are shown in Figures 20 through 23. The comparison points for Walnut Creek consisted of two composite samples collected along the river on September 30, 2002, and three composite samples collected on September 15, 2003.

There are no WWRP discharges in Walnut Creek. Therefore, simulated copper levels were based only on stormdrain loads. This resulted in relatively low flows (Table 2) that were subject to uncertainty. Regardless, copper levels in the creek were simulated by the modeling system relatively well. Assumptions for non-detects had no significant impact on model results for copper in Walnut Creek.

San Gabriel Dry-Weather Model Development – Draft

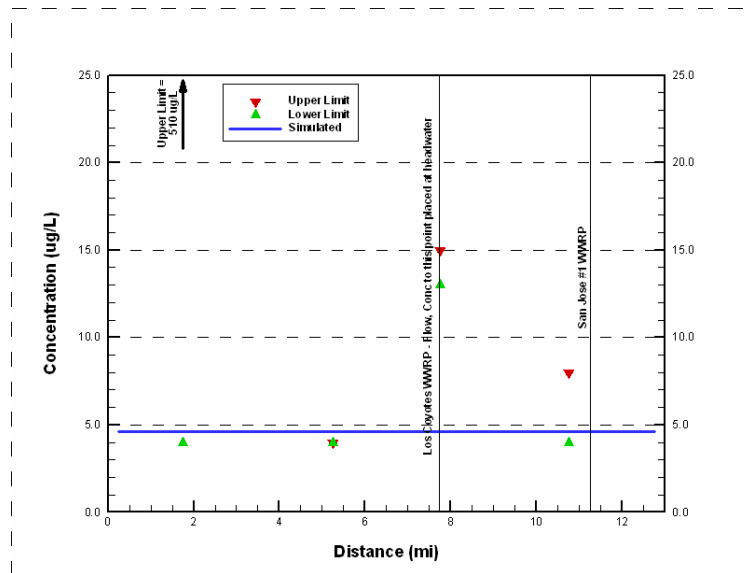

Figure 8. Simulated vs. observed Total Copper of San Gabriel River in September 2002 (1/2 detection limit for non-detects)

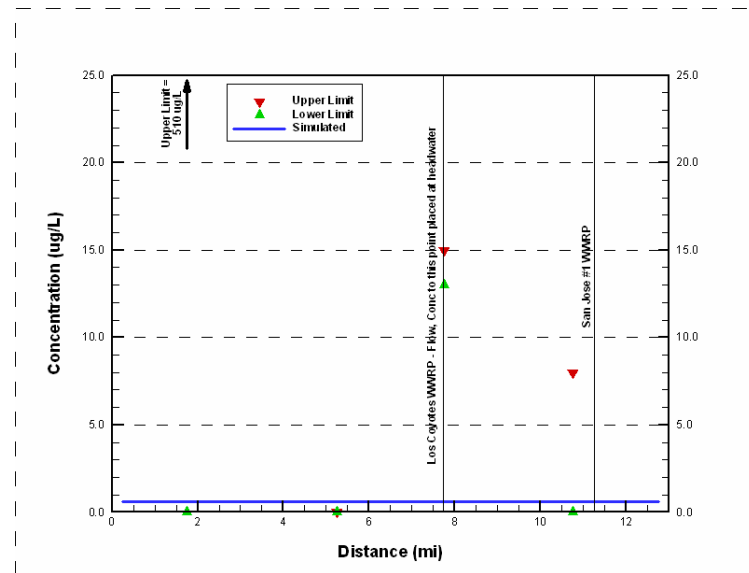

Figure 10. Simulated vs. observed Total Copper of San Gabriel River in September 2002 (zero for non-detects)

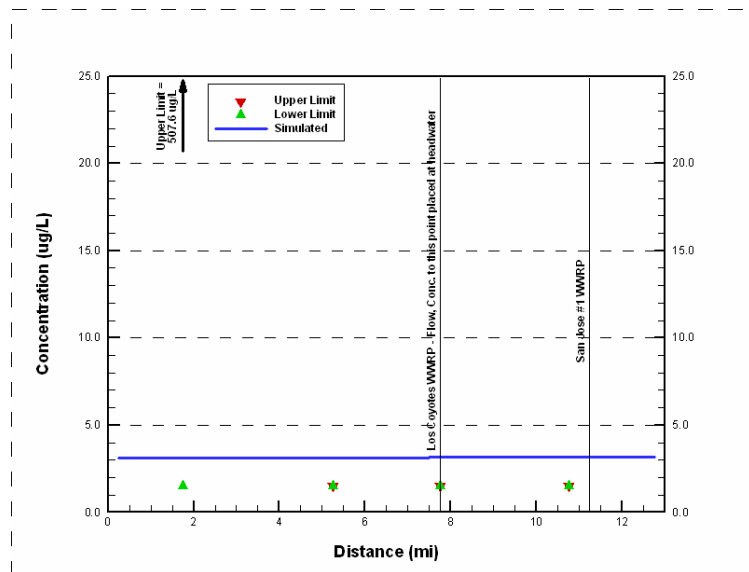

Figure 9. Simulated vs. observed Total Copper of San Gabriel River in September 2003 (1/2 detection limit for non-detects)

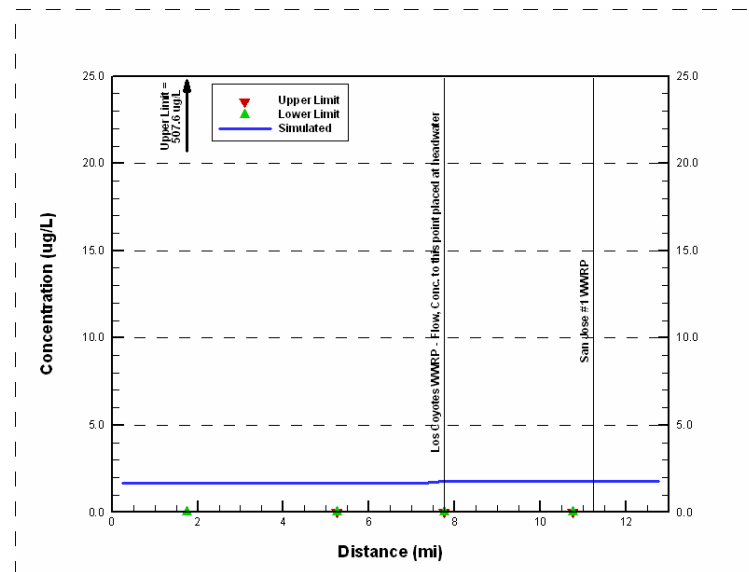

Figure 11. Simulated vs. observed Total Copper of San Gabriel River in September 2003 (zero for non-detects)

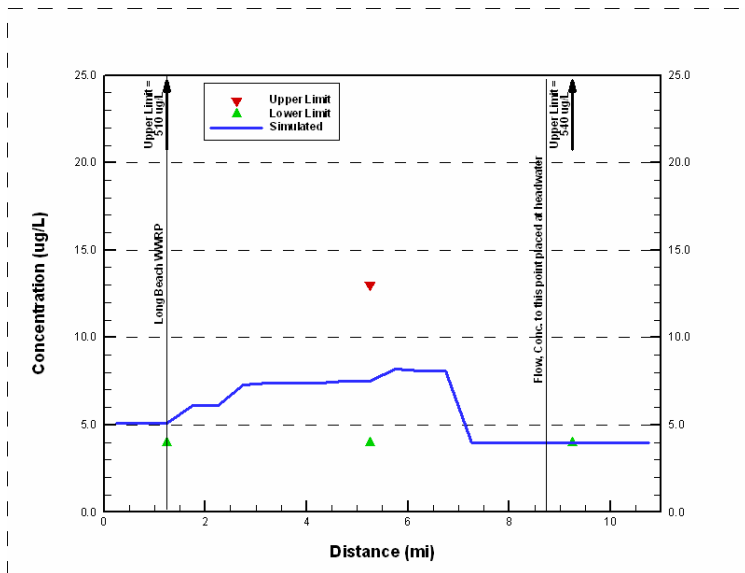

Figure 12. Simulated vs. observed Total Copper of Coyote Creek in September 2002 (1/2 detection limit for non-detects)

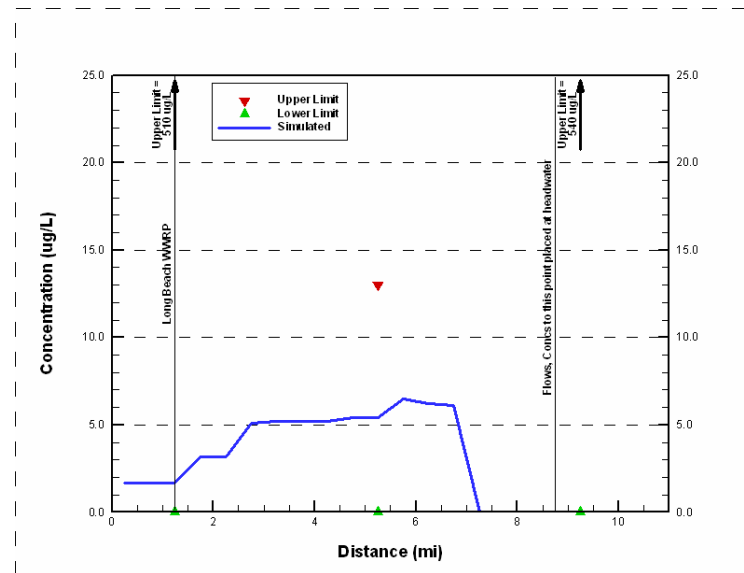

Figure 14. Simulated vs. observed Total Copper of Coyote Creek in September 2002 (zero for non-detects)

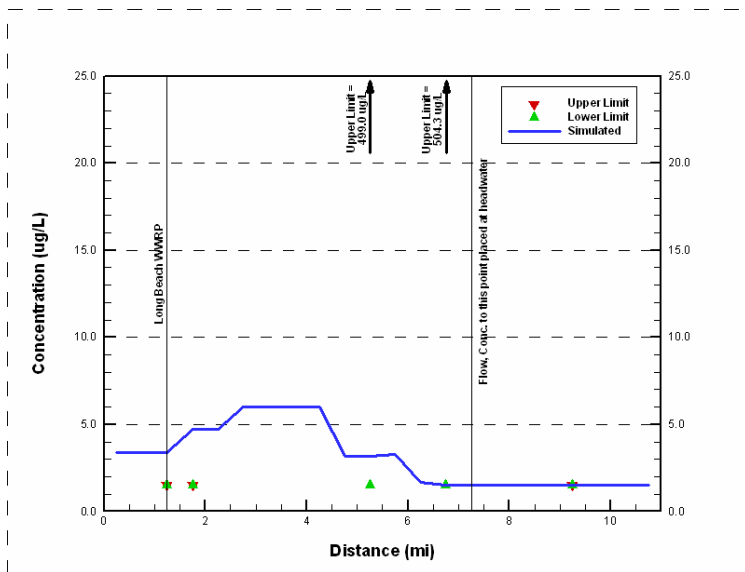

Figure 13. Simulated vs. observed Total Copper of Coyote Creek in September 2003 (1/2 detection limit for non-detects)

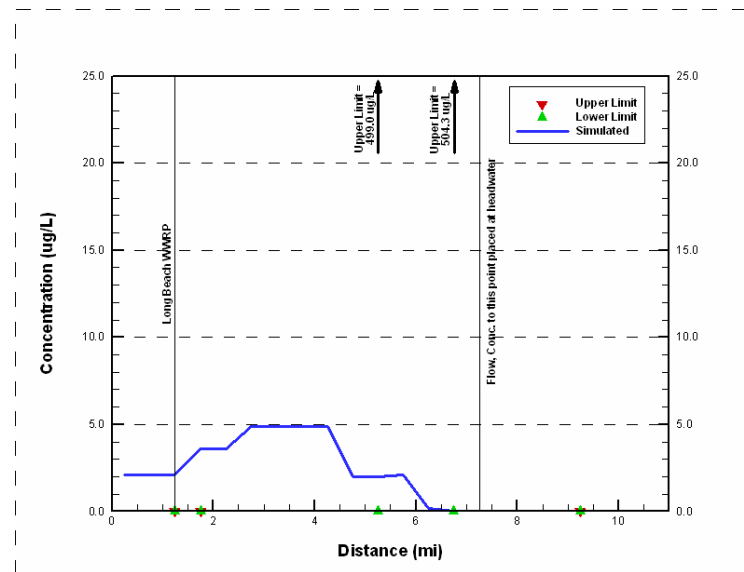

Figure 15. Simulated vs. observed Total Copper of Coyote Creek in September 2003 (zero for non-detects)

San Gabriel Dry-Weather Model Development – Draft

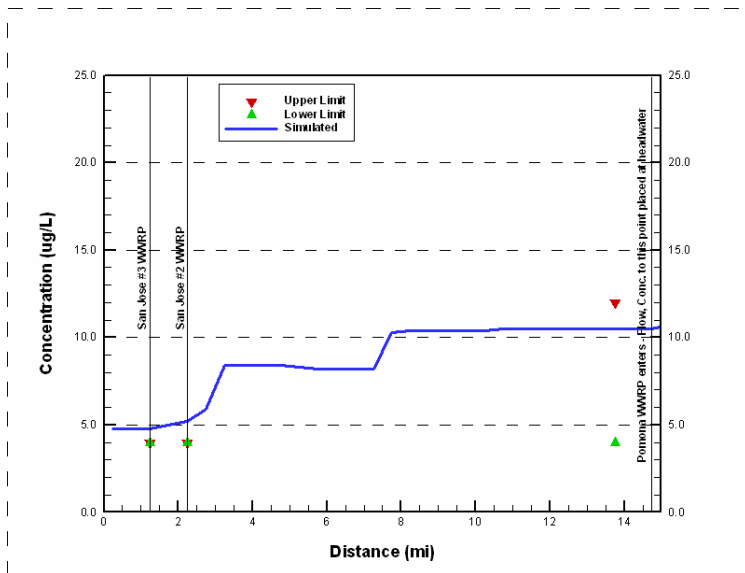

Figure 16. Simulated vs. observed Total Copper of San Jose Creek in September 2002 (1/2 detection limit for non-detects)

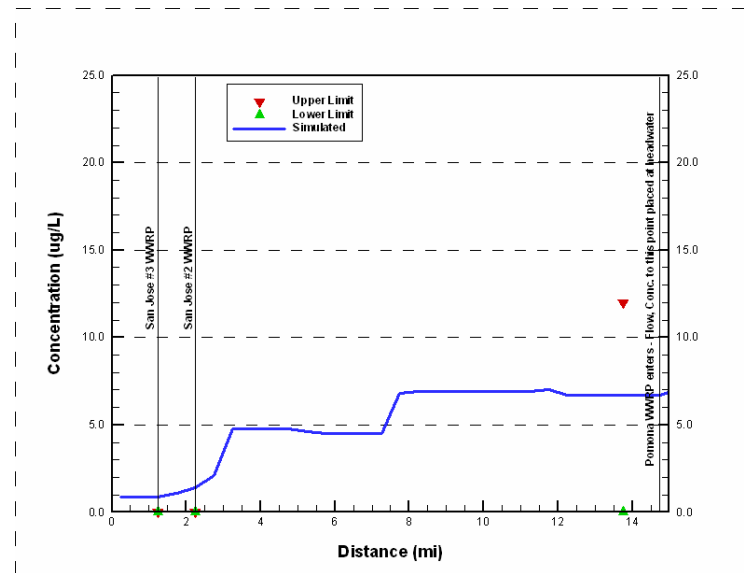

Figure 18. Simulated vs. observed Total Copper of San Jose Creek in September 2002 (zero for non-detects)

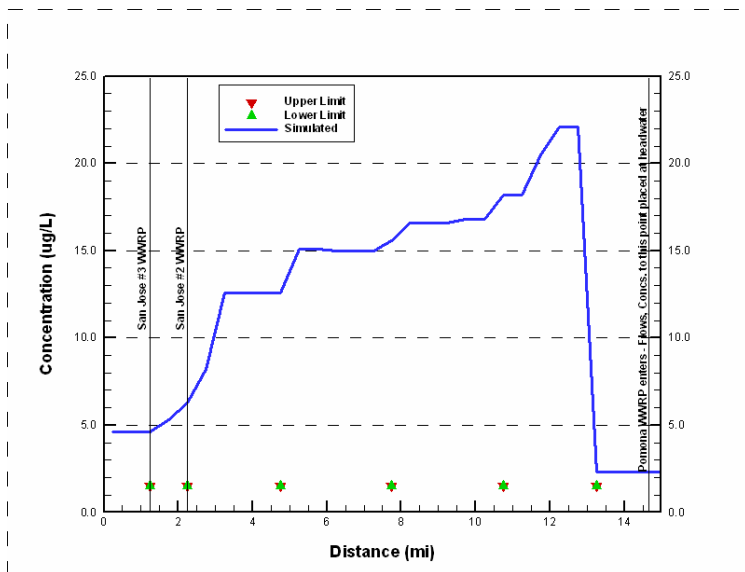

Figure 17. Simulated vs. observed Total Copper of San Jose Creek in September 2003 (1/2 detection limit for non-detects)

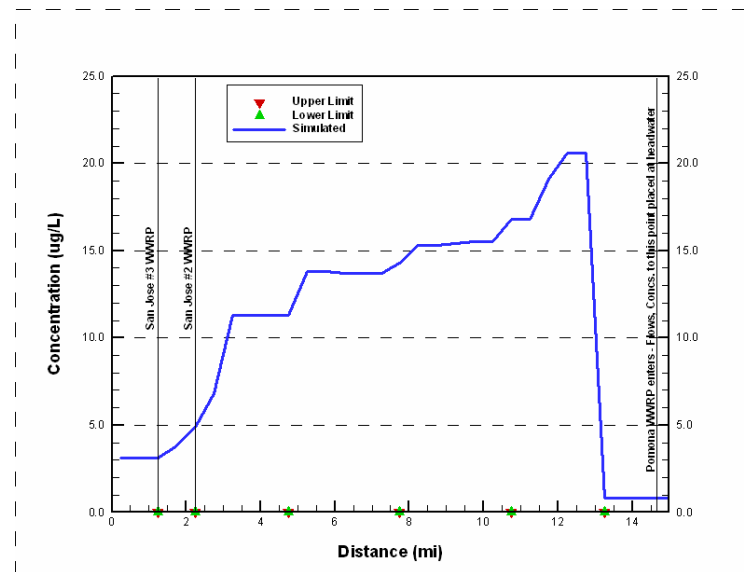

Figure 19. Simulated vs. observed Total Copper of San Jose Creek in September 2003 (zero for non-detects)

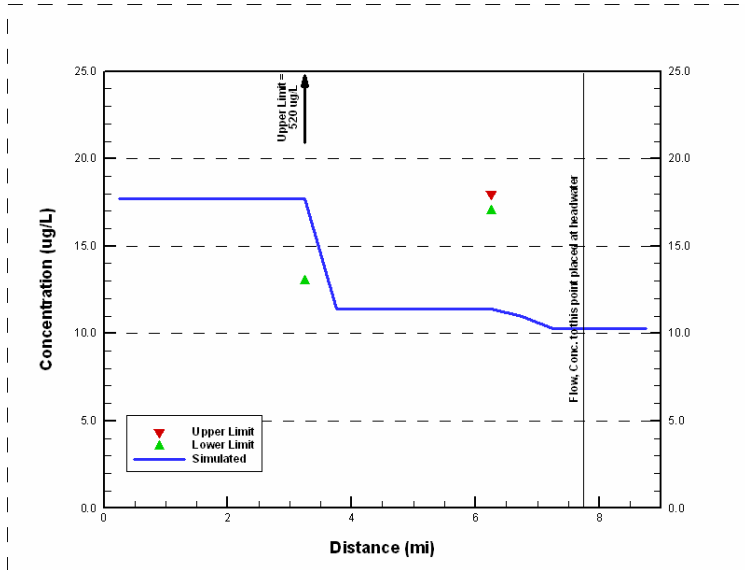

Figure 20. Simulated vs. observed Total Copper of Walnut Creek in September 2002 (1/2 detection limit for non-detects)

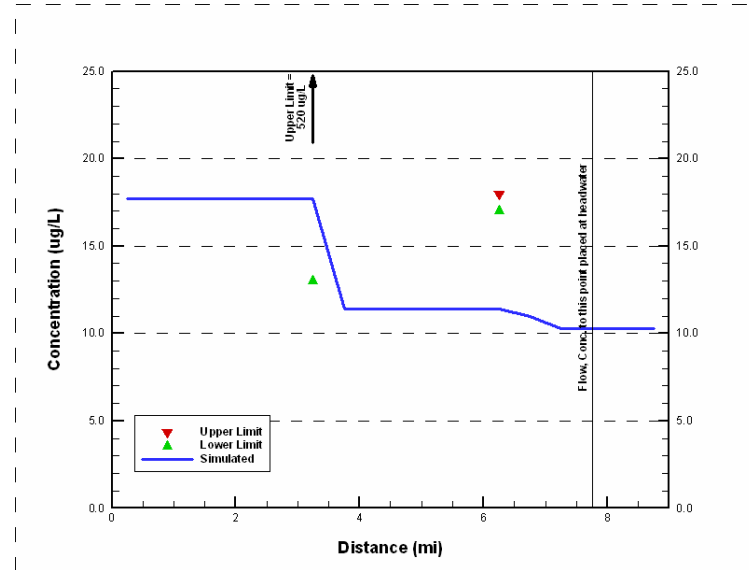

Figure 22. Simulated vs. observed Total Copper of Walnut Creek in September 2002 (zero for non-detects)

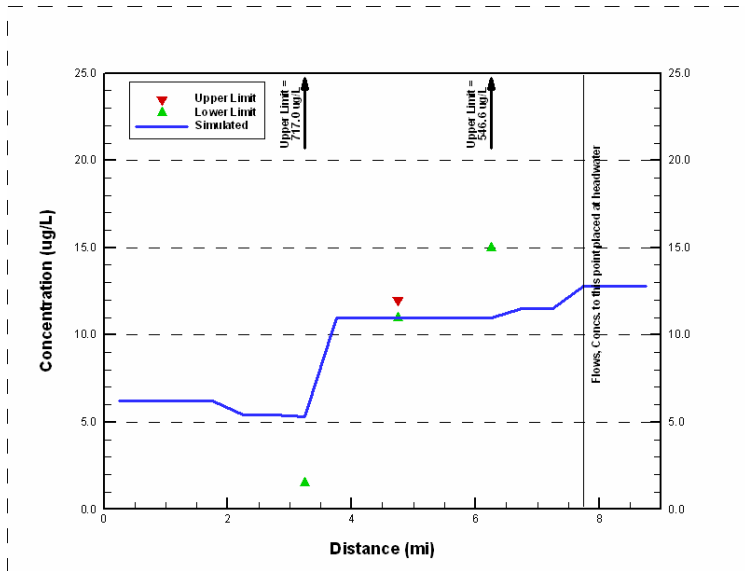

Figure 21. Simulated vs. observed Total Copper of Walnut Creek in September 2003 (1/2 detection limit for non-detects)

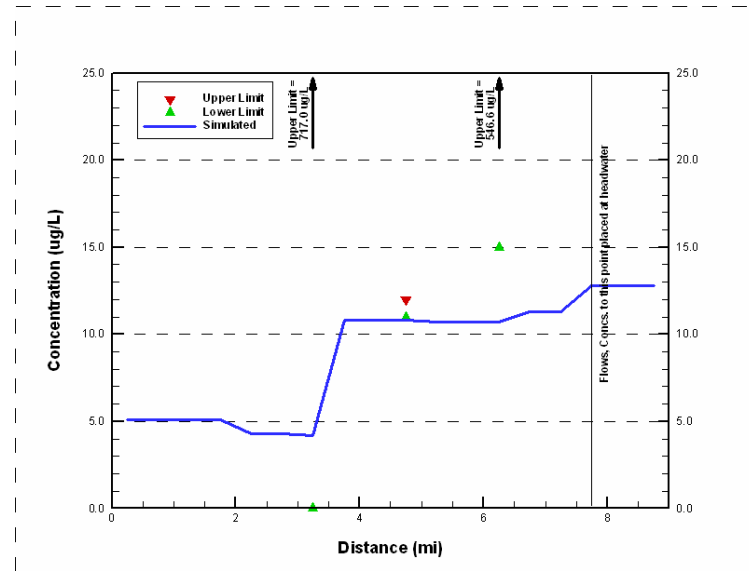

Figure 23. Simulated vs. observed Total Copper of Walnut Creek in September 2003 (zero for non-detects)

4.2 Model Simulations of Lead

Model results for lead within each reach are discussed in the following sections. For each reach, results are shown for both monitoring periods and assumptions for water quality non-detects for inflows (zero and half the detection limit).

4.2.1 San Gabriel River Lead Simulation

The water quality comparisons for lead for the San Gabriel River for the two monitoring periods and assumptions for water quality non-detects are shown in Figures 24 through 27. The comparison points for the San Gabriel River consisted of four composite samples collected along the river during both the September 2002 and 2003 monitoring periods.

Observed lead concentrations in the San Gabriel River are highly variable, with ranges sometimes varying by orders of magnitude for both monitoring periods. However, most of the measured lead levels in the river were at non-detectable levels in September 2002. Based on measured inflows used to represent model inputs, the simulated lead levels within the river were either above or close to the lower levels of the observed ranges. This was impacted by the Los Coyotes WWRP discharge, which had non-detectable lead levels (Table 4) and was therefore represented with assumptions for non-detects. As a result, model results show a noticeable relative impact of assumptions for inflow lead non-detects on instream water quality simulations. The net result of changing from half the detection limit to zero for non-detects at inflows to the river is a slight reduction in simulated lead levels in the river.

4.2.2 Coyote Creek Lead Simulation

The water quality comparisons for lead for Coyote Creek for the two monitoring periods and assumptions for water quality non-detects are shown in Figures 28 through 31. The comparison points for Coyote Creek consisted of three composite samples collected along the river during the September 2002 monitoring period, and five composite samples collected during the September 2003 period.

As with the San Gabriel River, observed ranges of lead concentrations in Coyote Creek vary by orders of magnitude, and differ between monitoring periods. However, model-simulated instream lead levels are slightly controlled by assumptions for inflows. As a result, assumptions for non-detects at these inflows can result in a slight reduction in simulated lead levels in the river, which is most noticeable above river mile 8.

4.2.3 San Jose Creek Lead Simulation

The water quality comparisons for lead in San Jose Creek for the two monitoring periods and assumptions for water quality non-detects are shown in Figures 32 through 35. Four composite samples were taken on San Jose Creek on September 30, 2002, however, one of these locations was located upstream of the simulated portion of the reach. Likewise, two of the eight composite samples collected during the September 15, 2003, period were upstream of the model domain. As was previously discussed, the upstream flows were combined and applied at approximately River Mile 15.0 to provide more consistent flow, depth, and model stability. Therefore, the comparison points for San Jose Creek consisted of three composite samples collected along the river on September 30, 2002, and six samples collected on September 15, 2003.

WWRP discharges heavily control instream flows and associated lead levels in San Jose Creek, especially in the lower portion of the creek below the San Jose WWRP discharges. Lead levels from the San Jose WWRP #2 and Pomona WWRP were based on assumptions for non-detects (Table 4), which were simulated based on levels assumed at either half the detection limit (0.2 ug/L) or zero. However, the noticeable spike in lead levels during the September 2003 period at the San Jose WWRP #3 discharge is due to the higher concentration of that discharge (Table 4). Inflows from stormdrain discharges also influence model results. For the September 2003 model scenario, it is clear that assumed lead loads for these stormdrain discharges did not result in model-simulated instream concentrations that were comparable to observed non-detectable levels within the creek channel. This anomaly may be due to additional influencing factors that were not accounted for in the model, or misrepresentation of loads from stormdrains based on the measured flows and lead concentrations. Assumptions for non-detects had no significant impact on model results for lead in San Jose Creek.

4.2.4 Walnut Creek Lead Simulation

The water quality comparisons for lead for Walnut Creek for the two monitoring periods and assumptions for water quality non-detects are shown in Figures 36 through 39. The comparison points for Walnut Creek consisted of two composite samples collected along the river on September 30, 2002, and three composite samples collected on September 15, 2003.

There are no WWRP discharges in Walnut Creek. Therefore, simulated lead levels were based only on stormdrain loads. This resulted in relatively low flows (Table 2) that were subject to uncertainty. Regardless, lead levels in the creek were simulated by the modeling system relatively well. Assumptions for non-detects had no significant impact on model results for lead in Walnut Creek.

San Gabriel Dry-Weather Model Development – Draft

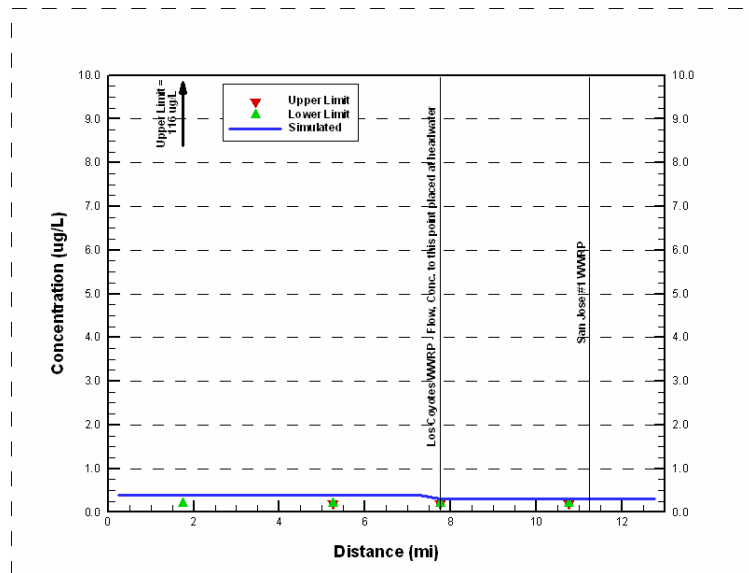

Figure 24. Simulated vs. observed Total Lead of San Gabriel River in September 2002 (1/2 detection limit for non-detects)

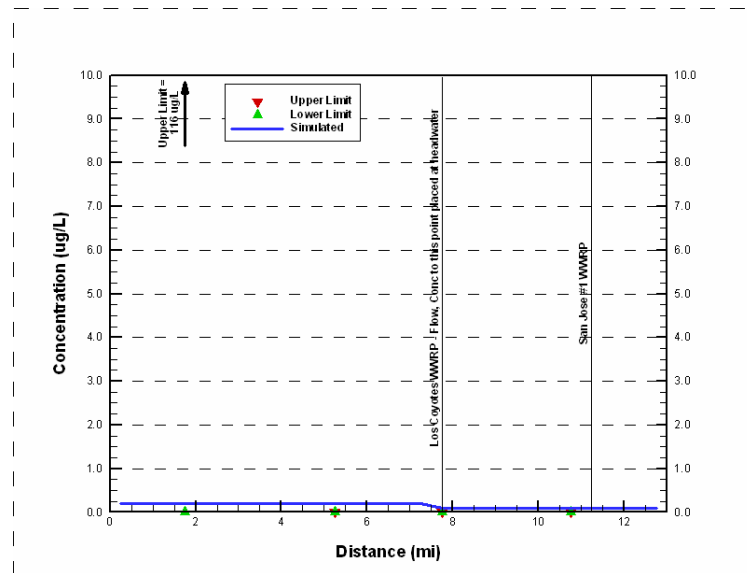

Figure 26. Simulated vs. observed Total Lead of San Gabriel River in September 2002 (zero for non-detects)

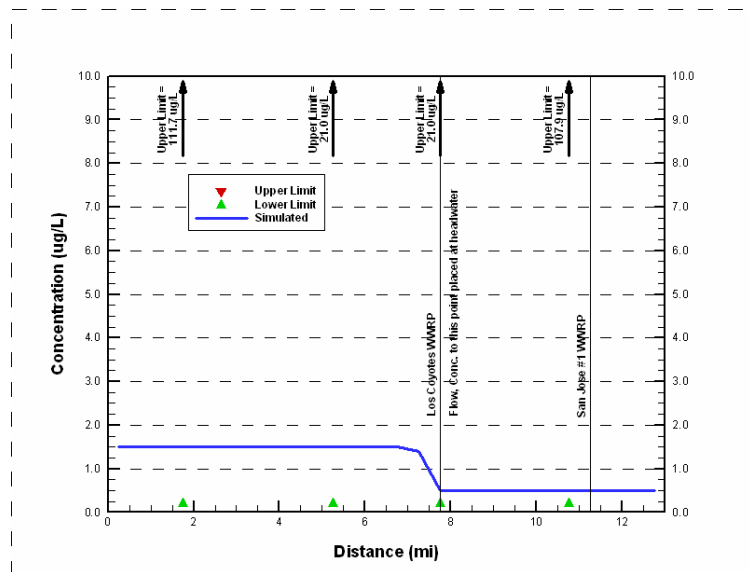

Figure 25. Simulated vs. observed Total Lead of San Gabriel River in September 2003 (1/2 detection limit for non-detects)

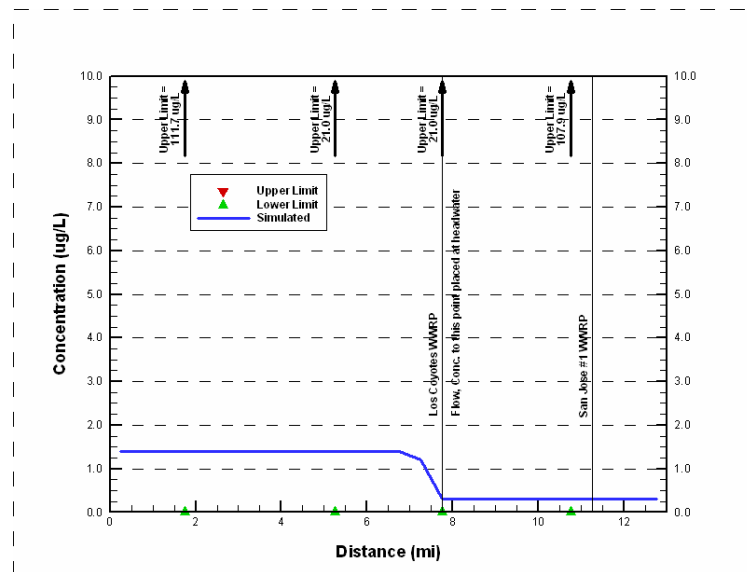

Figure 27. Simulated vs. observed Total Lead of San Gabriel River in September 2003 (zero for non-detects)

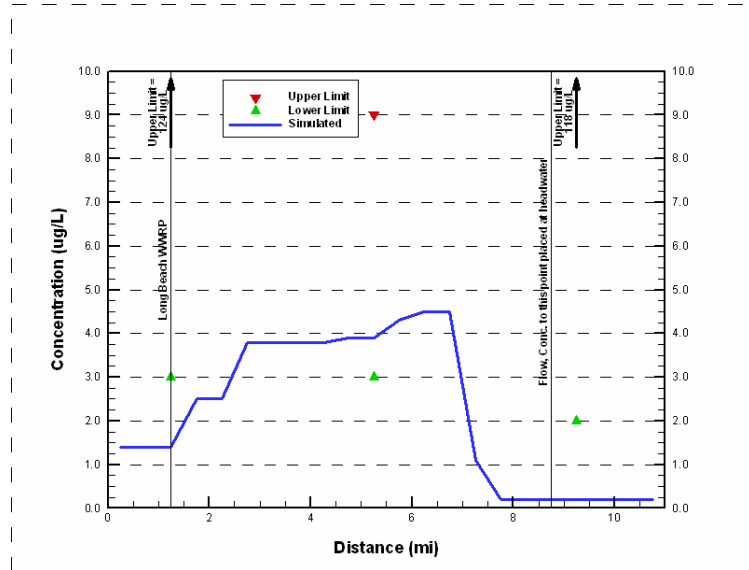

Figure 28. Simulated vs. observed Total Lead of Coyote Creek in September 2002 (1/2 detection limit for non-detects)

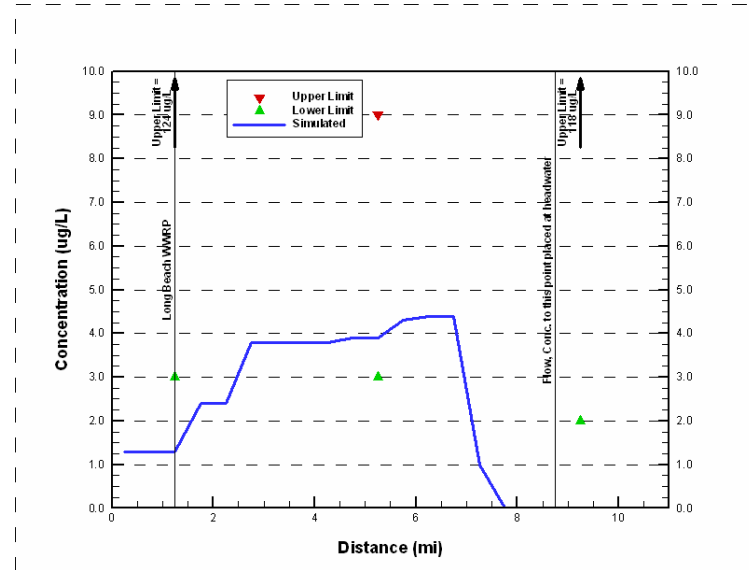

Figure 30. Simulated vs. observed Total Lead of Coyote Creek in September 2002 (zero for non-detects)

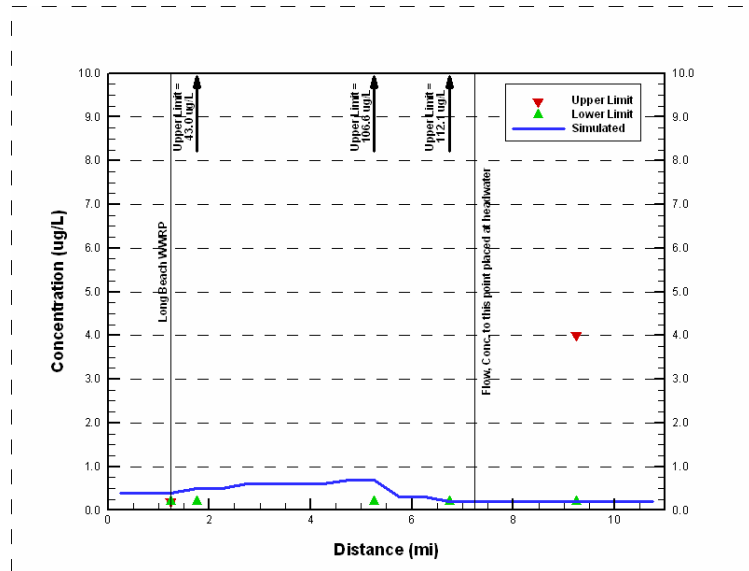

Figure 29. Simulated vs. observed Total Lead of Coyote Creek in September 2003 (1/2 detection limit for non-detects)

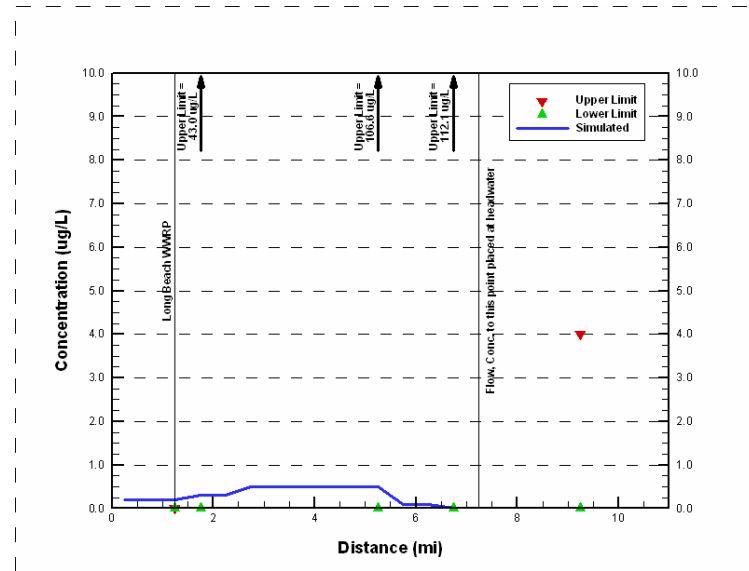

Figure 31. Simulated vs. observed Total Lead of Coyote Creek in September 2003 (zero for non-detects)

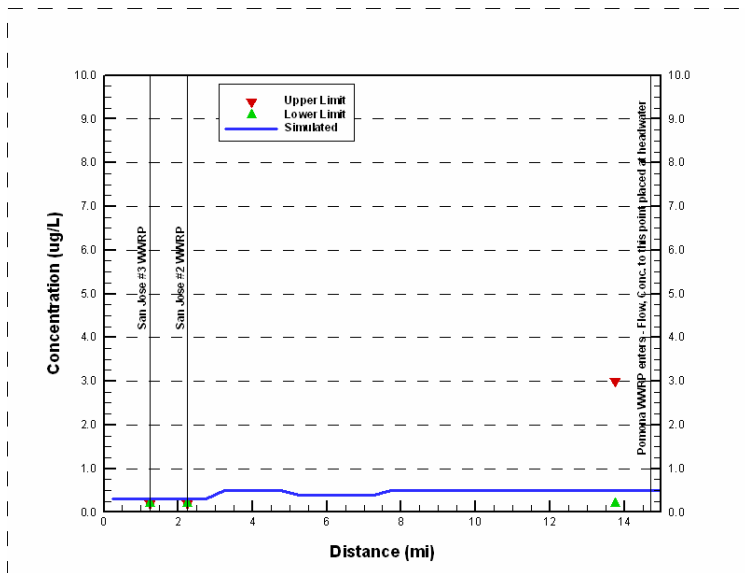

Figure 32. Simulated vs. observed Total Lead of San Jose Creek in September 2002 (1/2 detection limit for non-detects)

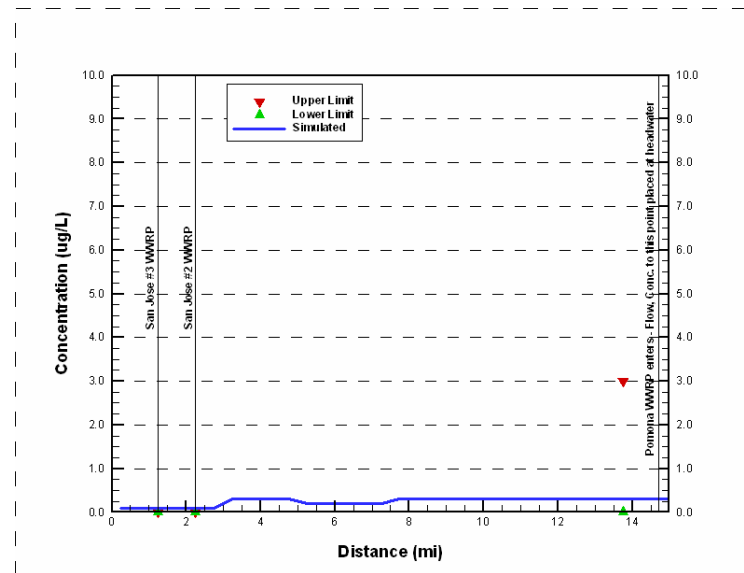

Figure 34. Simulated vs. observed Total Lead of San Jose Creek in September 2002 (zero for non-detects)

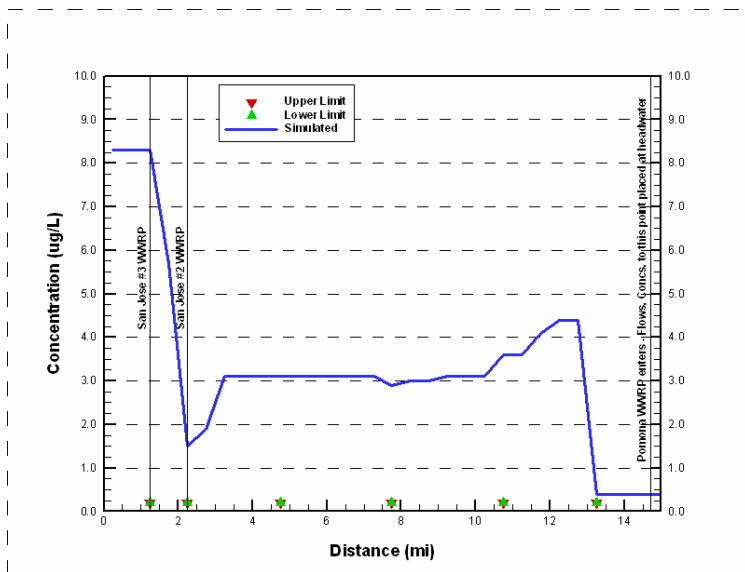

Figure 33. Simulated vs. observed Total Lead of San Jose Creek in September 2003 (1/2 detection limit for non-detects)

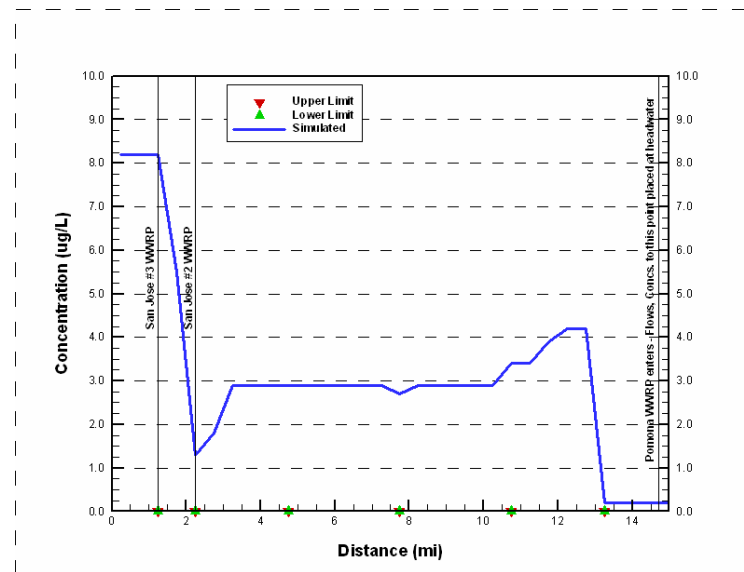

Figure 35. Simulated vs. observed Total Lead of San Jose Creek in September 2003 (zero for non-detects)

San Gabriel Dry-Weather Model Development – Draft

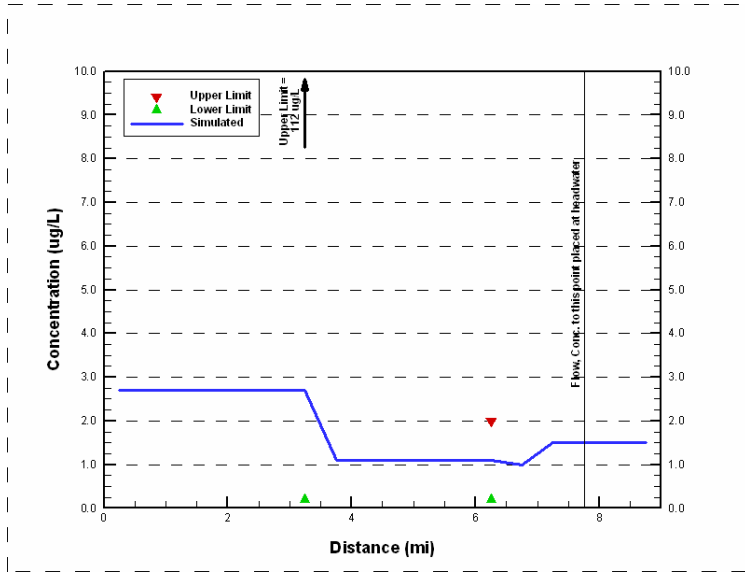

Figure 36. Simulated vs. observed Total Lead of Walnut Creek in September 2002 (1/2 detection limit for non-detects)

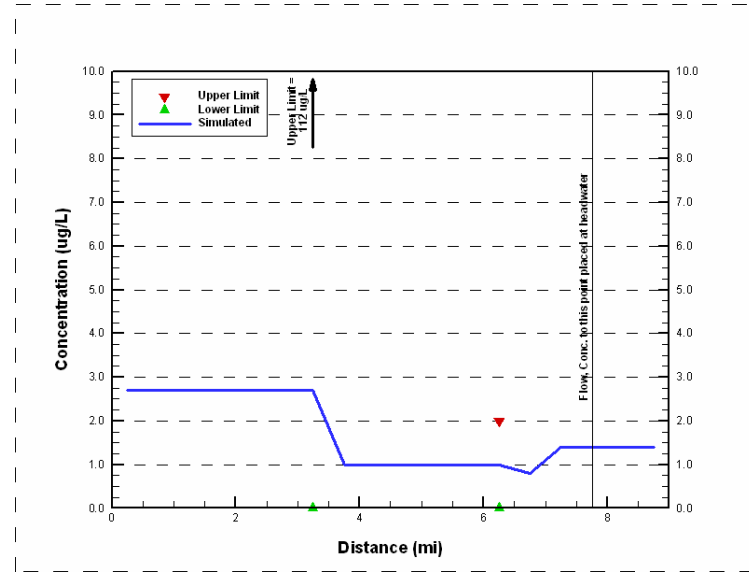

Figure 38. Simulated vs. observed Total Lead of Walnut Creek in September 2002 (zero for non-detects)

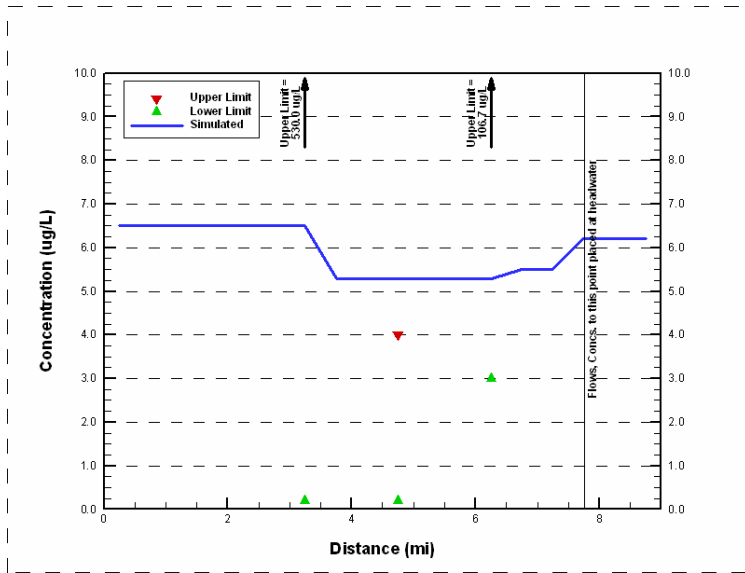

Figure 37. Simulated vs. observed Total Lead of Walnut Creek in September 2003 (1/2 detection limit for non-detects)

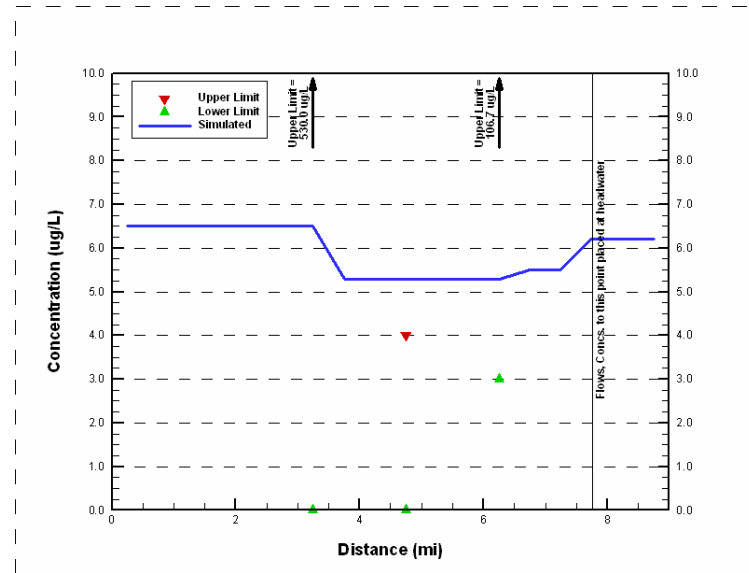

Figure 39. Simulated vs. observed Total Lead of Walnut Creek in September 2003 (zero for non-detects)

4.3 Model Simulations of Zinc

Model results for zinc within each reach are discussed in the following sections. For each reach, results are shown for both monitoring periods and assumptions for water quality non-detects for inflows (zero and half the detection limit).

4.3.1 San Gabriel River Zinc Simulation

The water quality comparisons for zinc for the San Gabriel River for the two monitoring periods and assumptions for water quality non-detects are shown in Figures 40 through 43. The comparison points for the San Gabriel River consisted of four composite samples collected along the river during both the September 2002 and 2003 monitoring periods.

All measured zinc levels in the river were at detectable levels during both monitoring periods. Based on measured inflows used to represent model inputs, the simulated zinc levels within the river were either below or close to the lower levels of the observed ranges. This was impacted by the Los Coyotes WWRP discharge, which had detectable copper levels of 30 and 65.2 ug/L in September 2002 and September 2003, respectively (Table 4). Changes of assumptions for non-detects at inflows to the river had no noticeable impact on model results.

4.3.2 Coyote Creek Zinc Simulation

The water quality comparisons for zinc for Coyote Creek for the two monitoring periods and assumptions for water quality non-detects are shown in Figures 44 through 47. The comparison points for Coyote Creek consisted of three composite samples collected along the river during the September 2002 monitoring period, and five composite samples collected during the September 2003 period. All measured zinc levels in the creek were at detectable levels during both monitoring periods.

Overall, model results for Coyote Creek compared relatively well with observed zinc levels. Some stormdrain discharges were characterized by non-detects, but assumptions for these had no noticeable impact on model results.

4.3.3 San Jose Creek Zinc Simulation

The water quality comparisons for zinc for San Jose Creek for the two monitoring periods and assumptions for water quality non-detects are shown in Figures 48 through 51. Four composite samples were taken on San Jose Creek on September 30, 2002, however, one of these locations was located upstream of the simulated portion of the reach. Likewise, two of the eight composite samples collected during the September 15, 2003, period were upstream of the model domain. As was previously discussed, the upstream flows were combined and applied at approximately River Mile 15.0 to provide more consistent flow, depth, and model stability. Therefore, the

comparison points for San Jose Creek consisted of three composite samples collected along the river on September 30, 2002, and six samples collected on September 15, 2003. All measured zinc levels in the creek were at detectable levels during both monitoring periods.

WWRP discharges heavily control instream flows and associated zinc levels in San Jose Creek. All WWRP discharges to the creek had notable concentrations of zinc (Table 4). The resulting loads, combined with stormdrain loads, resulted in model-simulated zinc levels in the creek that mostly exceeded observed ranges. Since most inflows to the creek were characterized by detectable zinc levels, assumptions for non-detects had no noticeable impact on model results.

4.3.4 Walnut Creek Zinc Simulation

The water quality comparisons for zinc for Walnut Creek for the two monitoring periods and assumptions for water quality non-detects are show in Figures 52 through 55. The comparison points for Walnut Creek consisted of two composite samples collected along the river on September 30, 2002, and three composite samples collected on September 15, 2003.

There are no WWRP discharges in Walnut Creek. Therefore, simulated zinc levels were based only on stormdrain loads. This resulted in relatively low flows (Table 2) that were subject to uncertainty. Regardless, zinc levels in the creek were simulated by the modeling system relatively well. Since most inflows to the creek were characterized by detectable zinc levels, assumptions for non-detects had no noticeable impact on model results.

San Gabriel Dry-Weather Model Development – Draft

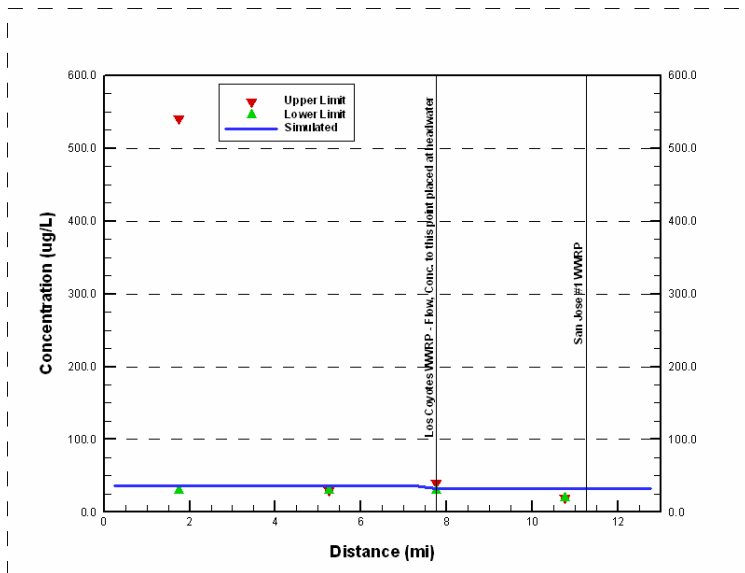

Figure 40. Simulated vs. observed Total Zinc of San Gabriel River in September 2002 (1/2 detection limit for non-detects)

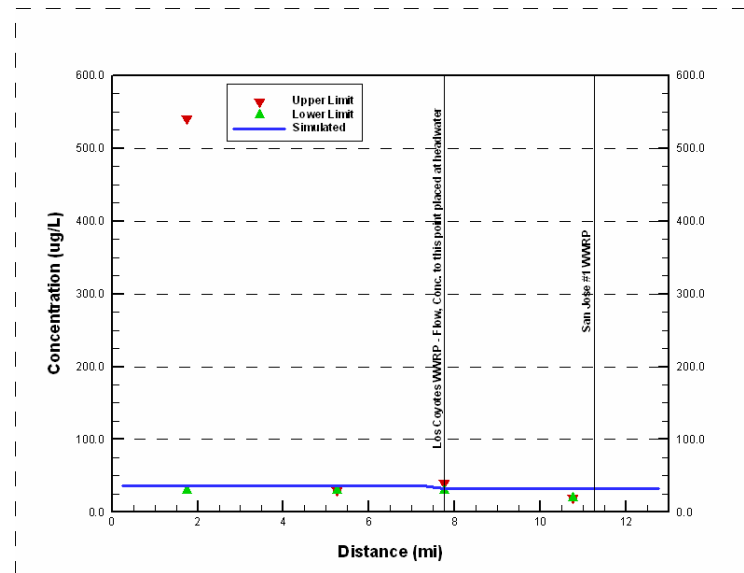

Figure 42. Simulated vs. observed Total Zinc of San Gabriel River in September 2002 (zero for non-detects)

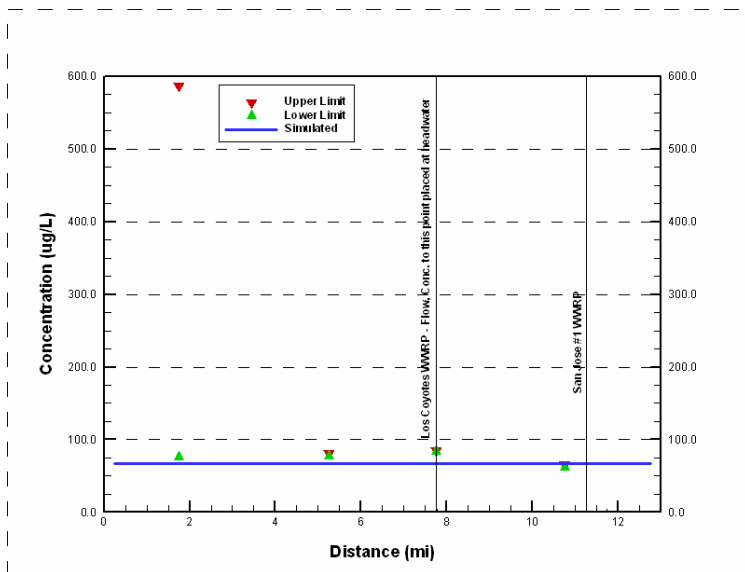

Figure 41. Simulated vs. observed Total Zinc of San Gabriel River in September 2003 (1/2 detection limit for non-detects)

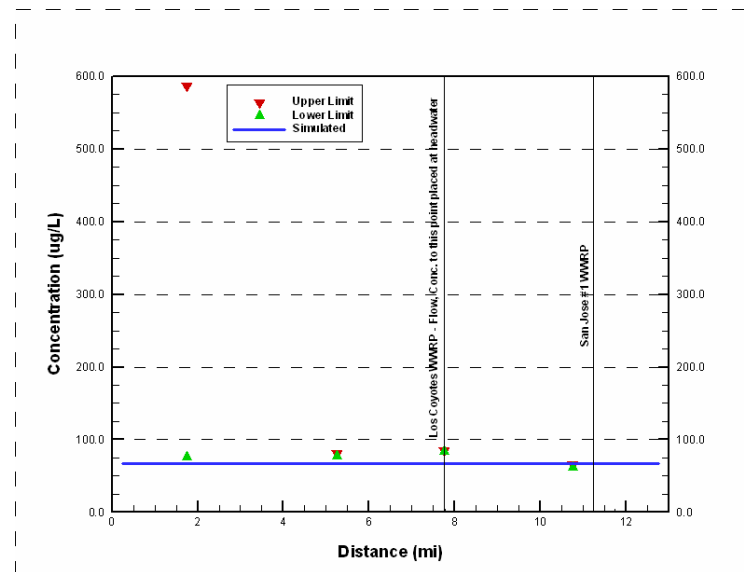

Figure 43. Simulated vs. observed Total Zinc of San Gabriel River in September 2003 (zero for non-detects)

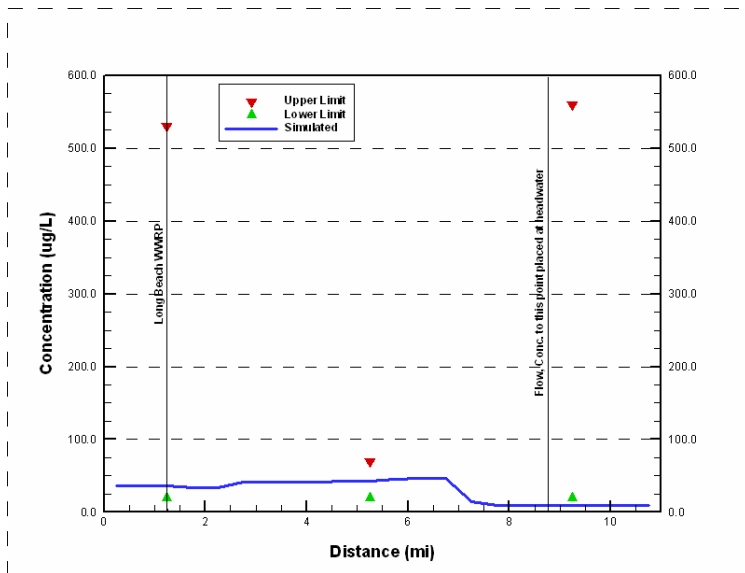

Figure 44. Simulated vs. observed Total Zinc of Coyote Creek in September 2002 (1/2 detection limit for non-detects)

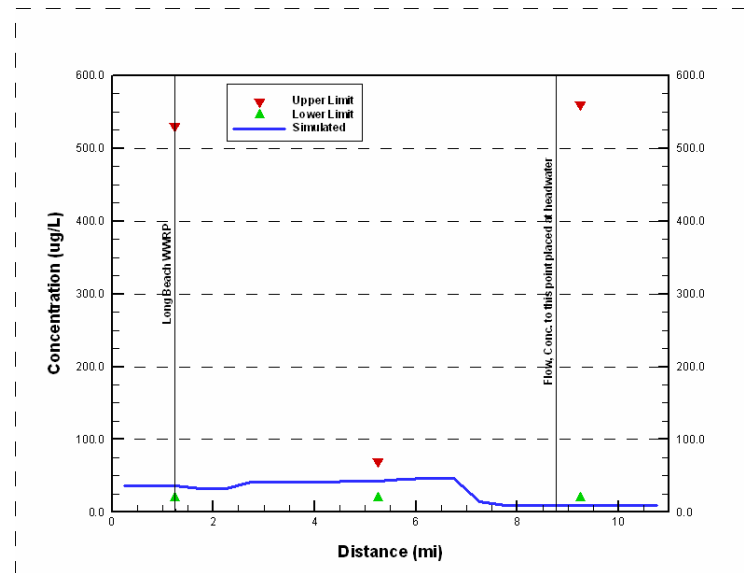

Figure 46. Simulated vs. observed Total Zinc of Coyote Creek in September 2002 (zero for non-detects)

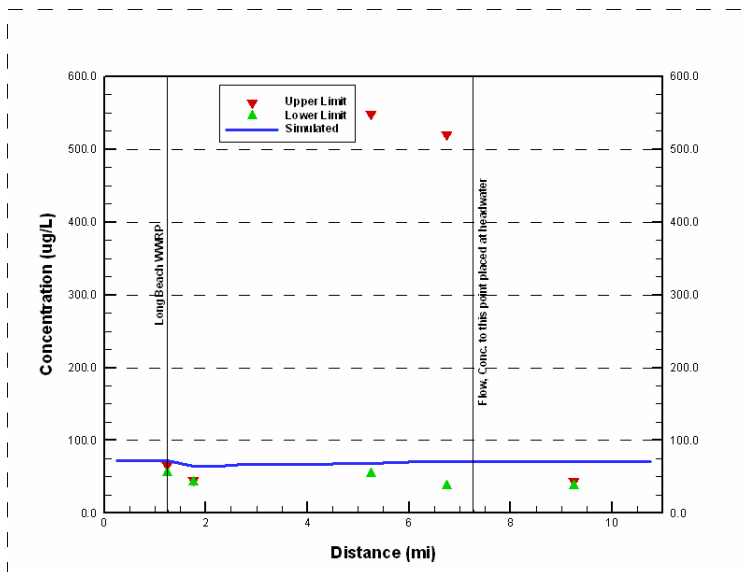

Figure 45. Simulated vs. observed Total Zinc of Coyote Creek in September 2003 (1/2 detection limit for non-detects)

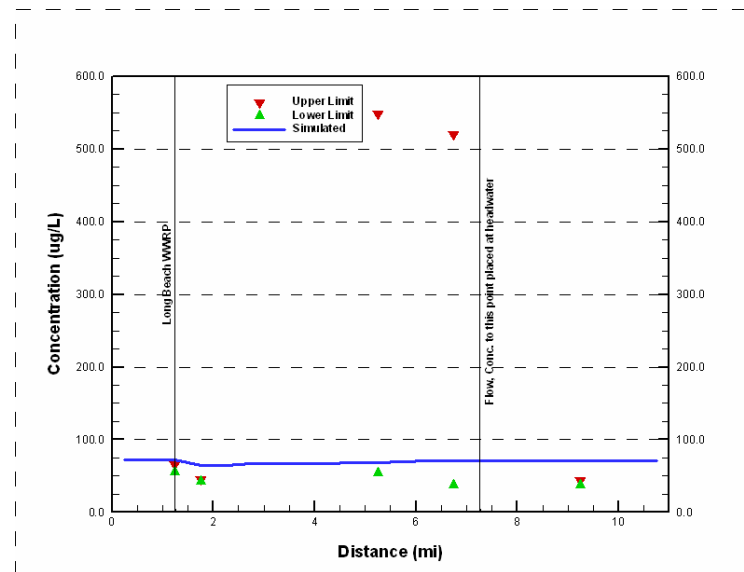

Figure 47. Simulated vs. observed Lower Total Zinc of Coyote Creek in September 2003 (zero for non-detects)

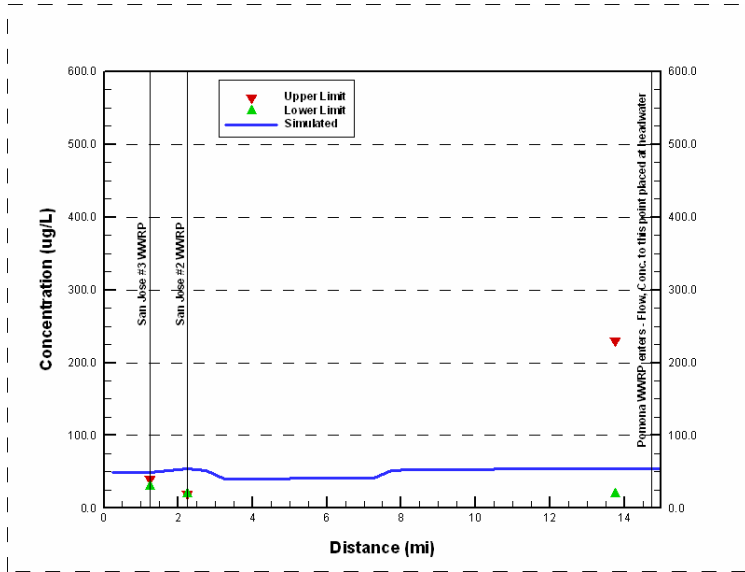

Figure 48. Simulated vs. observed Total Zinc of San Jose Creek in September 2002 (1/2 detection limit for non-detects)

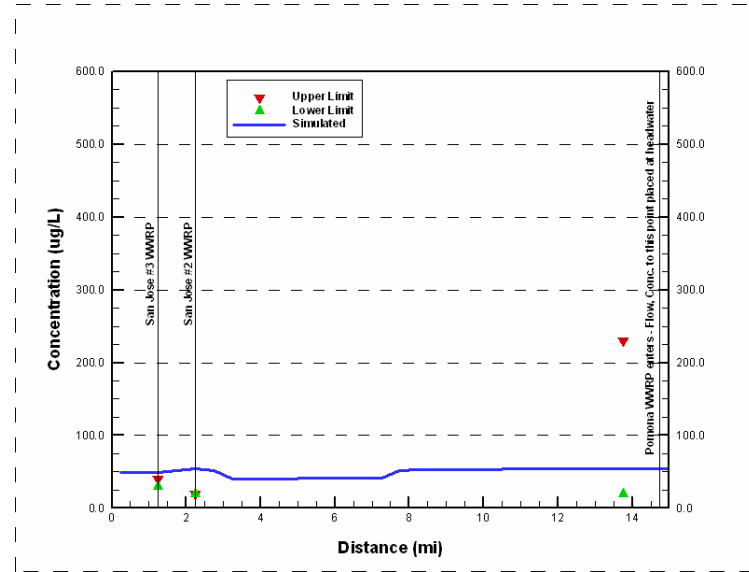

Figure 50. Simulated vs. observed Total Zinc of San Jose Creek in September 2002 (zero for non-detects)

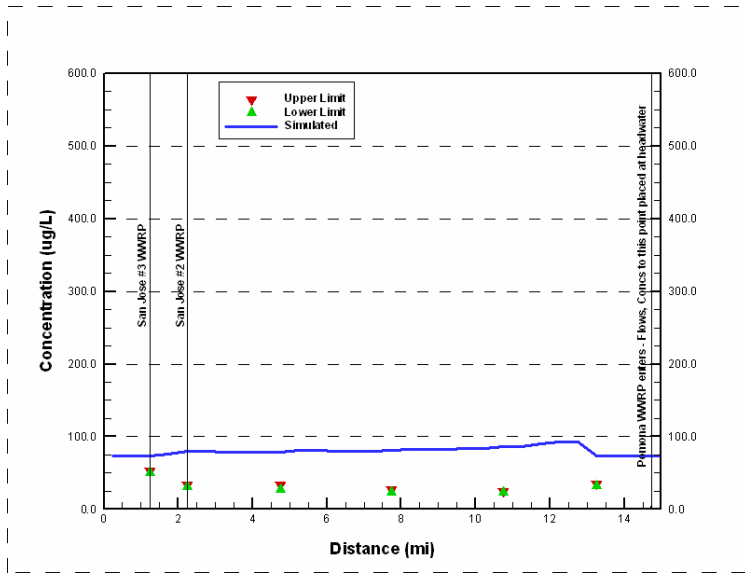

Figure 49. Simulated vs. observed Total Zinc of San Jose Creek in September 2003 (1/2 detection limit for non-detects)

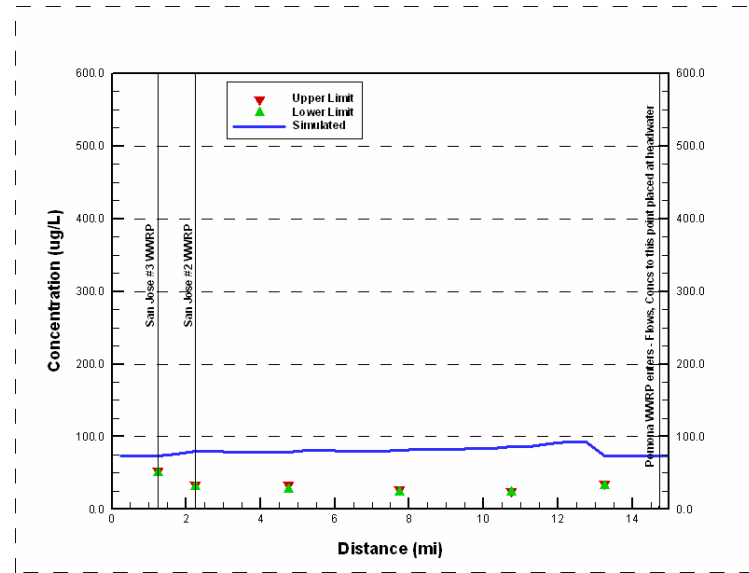

Figure 51. Simulated vs. observed Total Zinc of San Jose Creek in September 2003 (zero for non-detects)

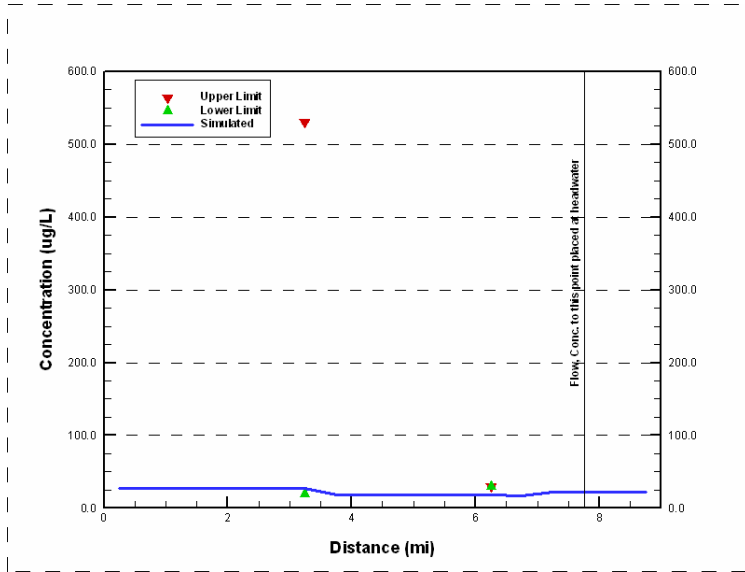

Figure 52. Simulated vs. observed Total Zinc of Walnut Creek in September 2002 (1/2 detection limit for non-detects)

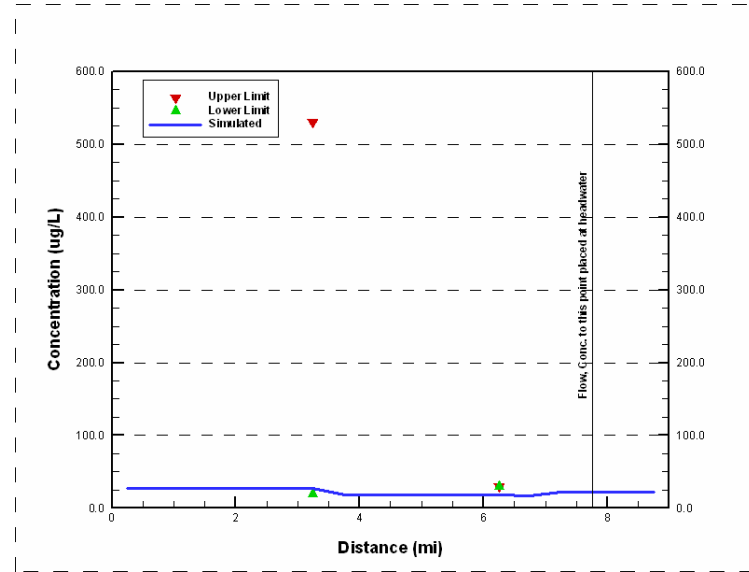

Figure 54. Simulated vs. observed Total Zinc of Walnut Creek in September 2002 (zero for non-detects)

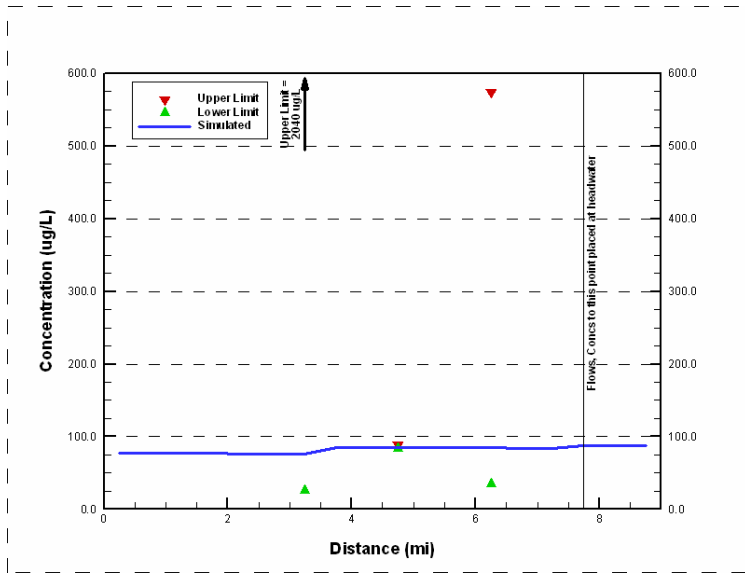

Figure 53. Simulated vs. observed Total Zinc of Walnut Creek in September 2003 (1/2 detection limit for non-detects)

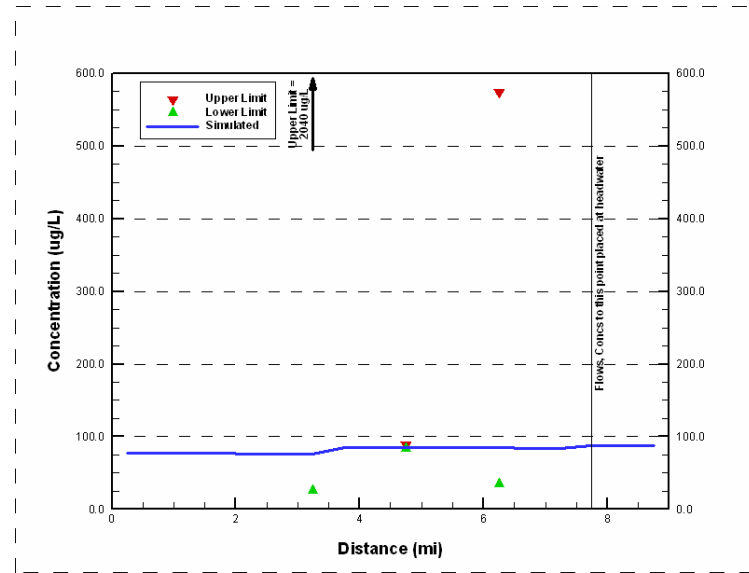

Figure 55. Simulated vs. observed Total Zinc of Walnut Creek in September 2003 (zero for non-detects)

4.4 Conclusions

As shown in Figures 8 through 55, the model appears to be simulating the water quality constituents in a reasonable manner. The magnitude of the results is similar to the observed concentrations. This is frequently due to a large range of concentrations measured instream. However, the simulated metals concentrations do not always compare consistently with the observed instream concentrations. Often this occurs where measurements were below detection limits. In other cases, there appear to be sources or other factors affecting metals concentrations in the reaches that are not accounted for in the model based on the observed data. More data collection to provide a range of observed dry-weather conditions can focus refinements of model assumptions to provide increased model resolution and improved predictive capability of typical low-flow conditions.

Assumptions for non-detects for discharges to the reaches have varied impacts on instream water quality depending on the location and constituent. Overall, assuming a value of zero for non-detects results in lower model-simulated metals concentrations than an assumption of half the detection limits. Very little observed instream metals concentrations were available for comparison to determine which assumption for detection limits resulted in the best model results. Furthermore, many of the instream locations that were most impacted by non-detect assumptions were also characterized by non-detectable levels, preventing useful comparison. Therefore, although results of this analysis can provide guidance regarding the relative impact of non-detect assumptions on model-simulation of instream concentrations, these results are too inconclusive to provide definitive guidance regarding which assumption is most appropriate. Where these assumptions can result in metals concentrations that exceed instream water quality targets, caution should be exercised.

Overall, it appears that the model can be a valuable tool to predict water quality trends and magnitudes for evaluation of sources and water quality impacts in the system, but could be improved with additional data. As more water quality and hydrodynamic data are collected, the models can be further tested and calibrated to provide improved simulation of average dry-weather conditions. The models provide a useful linkage analysis tool for assessing the assimilative capacity of the reaches, the impact of loadings from WWRPs and stormdrain loads, and the transport of these loads through the watershed and to the estuary. Furthermore, the models can be further modified and used to assess alternative scenarios for watershed planning or assessment of alternative control measures, providing a foundation for future planning initiatives to potentially address TMDL implementation or other planning initiatives.

5. References

Ackerman, D., E. Stein, and K. Schiff. 2004. *Dry-season Water Quality in the San Gabriel River Watershed*. Southern California Coastal Water Research Project, Annual Report 2003-2004. Westminster, CA.

Ambrose, R.B. et al. 1988. *WASP4, A Hydrodynamic and Water Quality Model--Model Theory, User's Manual, and Programmer's Guide*. U.S. Environmental Protection Agency, Athens, GA. EPA/600/3-87-039.

Caupp, C.L., Brock, J.T., and Runke, H.M. 1991. *Application of the dynamic stream simulation and assessment model (DSSAM III) to the Truckee River below Reno, Nevada. Model formulation and program description*. Prepared by Rapid Creek Water Works for Nevada Division of Environmental Protection, Carson City and Washoe County Department of Comprehensive Planning, Reno, NV.

Connolly, J.P., and Winfield, R. 1984. *A User's Guide for WASTOX, a Framework for Modeling the Fate of Toxic Chemicals in Aquatic Environments. Part I: Exposure Concentration*. U.S. Environmental Protection Agency, Gulf Breeze, FL.

DiToro, D.M., Fitzpatrick, J.J., and Thomann, R.V. 1981, rev. 1983. *Water Quality Analysis Simulation Program (WASP) and Model Verification Program (MVP) - Documentation*. Hydroscience, Inc., Westwood, NY, for U.S. Environmental Protection Agency, Duluth, MN, Contract No. 68-01-3872.

Hamrick, J.M. 1996. *A User's Manual for the Environmental Fluid Dynamics Computer Code (EFDC)*. The College of William and Mary, Virginia Institute of Marine Science, Special Report 331, 234 pp.

LARWQCB. 1998. *Los Angeles River Watershed Water Quality Characterization*. First Edition. April 1998. California Regional Water Quality Control Board, Los Angeles Region, CA.

NDEP. 1982. *Water Quality Management (208) Plan for the Carson River Basin, Nevada*. Nevada Division of Environmental Protection, Department of Conservation and Natural Resources.

Thomann, R.V., and Mueller, J.A. 1987. *Principles of Surface Water Quality Modeling and Control*. Harper & Row, New York. 644 pp.

Warwick, J.J., Cockrum, D., and Horvath, M. 1997. Estimating Non-Point Source Loads and Associated Water Quality Impacts. *Journal of Water Resources Planning and Management*.

Whitford, L.A., and Schumacher, G.J. 1964. "Effect of current on respiration and mineral uptake in Spirogyra and Oedogonium." *Ecology*, 45, 168-170.