

# ECOLOGICAL RISK ASSESSMENT Guidance Document



February 2003  
Revised April 2008

# **Guidance for Conducting Ecological Risk Assessments**

DERR - 00 - RR - 031

October 2006  
Revised April 2008

**State of Ohio  
Environmental Protection Agency Division of  
Environmental Response and Revitalization  
P.O. Box 1049  
Lazarus Government Center  
Columbus, Ohio 43216-1049**

# TABLE OF CONTENTS

		<u>Page</u>
Ohio EPA Districts .....		v
Acknowledgments .....		vi
Acronyms .....		vii
Chapter 1	<b>OVERVIEW</b> .....	1-1
	1.1 Overview of the Ecological Risk Assessment Process .....	1-1
	1.1.1 Level I - Scoping Ecological Risk Assessment .....	1-4
	1.1.2 Level II - Screening Ecological Risk Assessment .....	1-4
	1.1.3 Level III - Baseline Ecological Risk Assessment .....	1-5
	1.1.4 Level IV - Field Baseline Ecological Risk Assessment .....	1-5
Chapter 2	<b>Level I - Scoping Ecological Risk Assessment</b>	
	2.1 Objective .....	2-1
	2.2 Prerequisites .....	2-1
	2.3 Tasks .....	2-1
	2.3.1 Task 1: Assess Existing Data .....	2-1
	2.3.2 Task 2: Site Information and Identification of Important Ecological Resources .....	2-2
	2.3.3 Task 3: Identify Potential Chemical and Non-chemical Stressors .....	2-2
	2.3.4 Task 4: Level I Assessment .....	2-3
	2.3.5 Task 5: Submit Level I Deliverable .....	2-3
	<b>ATTACHMENTS</b>	
	ATTACHMENT A – Ecological Phase I Site Assessment .....	2-4
	ATTACHMENT B - Ecological Scoping Checklist .....	2-8
	ATTACHMENT C - Evaluation of Potential Ecological Harm .....	2-12
	ATTACHMENT D - Level I Deliverable Outline .....	2-13
	ATTACHMENT E - ODNR Species Information .....	2-14
Chapter 3	<b>Level II - Screening Ecological Risk Assessment</b>	
	3.1 Objective .....	3-1
	3.2 Prerequisites .....	3-1
	3.3 Tasks	
	3.3.1 Task 1: Evaluate Existing Site Data .....	3-2
	3.3.2 Task 2: Site Characterization .....	3-2
	3.3.3 Task 3: Data/Media Evaluation .....	3-2
	Frequency of Detection .....	3-3
	Common Laboratory Contaminants .....	3-3
	Background Concentrations .....	3-3
	Ohio Sediment Reference Values (SRVs) .....	3-4
	3.3.4 Task 4: Scientific Management Decision Point .....	3-4
	3.3.5 Task 5: Screening .....	3-5
	Soil .....	3-5
	Surface Water .....	3-7
	Sediment .....	3-7

	Persistent, Bioaccumulative, and Toxic Pollutants . . .	3-7
	Cumulative Effects . . . . .	3-7
	Benchmark Availability . . . . .	3-8
	State and/or Federal Listed Species . . . . .	3-8
3.3.6 Task 6:	COPEC Selection . . . . .	3-8
3.3.7 Task 7:	Conduct Site Survey . . . . .	3-8
3.3.8 Task 8:	Update Site Description . . . . .	3-9
3.3.9 Task 9:	Revise Conceptual Site Model . . . . .	3-9
3.3.10 Task 10:	Identify Ecological Receptors . . . . .	3-9
3.3.11 Task 11:	Identify Complete Exposure Pathways . . . . .	3-10
3.3.12 Task 12:	Identify Candidate Assessment Endpoints . . . . .	3-11
3.3.13 Task 13:	Scientific Management Decision Point (SMDP) . . . . .	3-12
3.3.14 Task 14:	Submit Level II Report . . . . .	3-12

**ATTACHMENTS**

	ATTACHMENT A - Flowchart and Legend . . . . .	3-14
	ATTACHMENT B - Potential Ecological Contaminants of Concern . . . . .	3-22
	ATTACHMENT C - Summary of Ecological Receptors . . . . .	3-23
	ATTACHMENT D - Exposure Routes for Ecological Receptors by Environmental Media . . . . .	3-24
	ATTACHMENT E - CSM Diagram . . . . .	3-25
	ATTACHMENT F - Level II Report . . . . .	3-26
	ATTACHMENT G - Point of Compliance . . . . .	3-27
	ATTACHMENT H - Ohio Specific Sediment Reference Values . . . . .	3-28
	ATTACHMENT I - Generic Receptor Species List . . . . .	3-35

**Chapter 4 Level III - Baseline Ecological Risk Assessment**

4.1	Objective . . . . .	4-1
4.2	Prerequisites . . . . .	4-1
4.3	Tasks	
4.3.1	Task 1: Complete Problem Formulation . . . . .	4-1
4.3.2	Task 2: Prepare Analysis Plan . . . . .	4-2
4.3.3	Task 3: Perform Exposure Assessment . . . . .	4-3
4.3.4	Task 4: Perform Toxicity Assessment . . . . .	4-4
4.3.5	Task 5: Perform Risk Characterization . . . . .	4-5
4.3.6	Task 6: Perform Uncertainty Analysis . . . . .	4-7
4.3.7	Task 7: Scientific Management Decision Point (SMDP) . . . . .	4-8
4.3.8	Task 8: Submit Level III Deliverable . . . . .	4-8
4.3.9	Task 9: Scientific Management Decision Point (SMDP) . . . . .	4-8

**ATTACHMENTS**

	ATTACHMENT A - Generic Receptors . . . . .	4-9
	ATTACHMENT B - Exposure Assessment . . . . .	4-15
	ATTACHMENT C - Toxicity Assessment . . . . .	4-25
	ATTACHMENT D - Receptor Life History Data . . . . .	4-36
	ATTACHMENT E - Level III Report - Outline . . . . .	4-47

**Chapter 5 Level IV - Field Baseline Ecological Risk Assessment**

5.1	Objective . . . . .	5-1
5.2	Prerequisites . . . . .	5-1
5.3	Tasks	
5.3.1	Task 1: Refine Problem Formulation . . . . .	5-1

	Select COECs .....	5-1
	Review/revise Establish Measures .....	5-1
5.3.2 Task 2:	Select Assessment Tools .....	5-2
	Tissue Analysis/Bioaccumulation Studies .....	5-2
	Population/Community Evaluations/ Toxicity Tests (Bioassay) .....	5-2
5.3.3 Task 3:	Prepare Field Ecological Sampling and Analysis Plan	5-3
5.3.4 Task 4:	Conduct Field/Laboratory Work .....	5-4
5.3.5 Task 5:	Perform Risk Characterization .....	5-4
5.3.6 Task 6:	Perform Uncertainty Analysis .....	5-4
5.3.7 Task 7:	Submit Level IV deliverable .....	5-4
ATTACHMENTS		
	ATTACHMENT A - Useful References .....	5-5
CHAPTER 6	<b>Definitions</b>	
	Definitions .....	6-1
CHAPTER 7	<b>Literature Cited</b>	
	Literature Cited .....	7-1

# Ohio Environmental Protection Agency

## Division of Environmental Response and Revitalization

Central Office \*  
P.O. Box 1049  
Columbus, Ohio 43216-1049  
Phone: (614) 644-2924  
Fax: (614) 644-3146

Central District Office  
PO Box 1049  
Columbus, Ohio 43216-1049  
Phone: (614)728-3778  
Fax: (614)728-3898

Southeast District Office  
2195 Front Street  
Logan, Ohio 43138  
Phone: (740)385-8501  
Fax: (740)385-6490

Northeast District Office  
2110 East Aurora Road  
Twinsburg, Ohio 44087  
Phone: (330)963-1200  
Fax: (330)487-0769

Southwest District Office  
401 East Fifth Street  
Dayton, Ohio 45402-2911  
Phone: (937)285-6357  
Fax: (937)285-6249

Northwest District Office  
347 North Dunbridge Road  
Bowling Green, Ohio 43402  
Phone: (419)352-8461  
Fax: (419)352-8468

\* Specific questions regarding the methodologies given in this guidance should be directed to Central Office. Specific questions regarding the application of the guidance to a specific Site or Property should be directed to the Site coordinator or VAP representative.

## **ACKNOWLEDGMENTS:**

The ecological risk assessment (ERA) process proposed in this document is based on several federal and state guidance documents modified to reflect conditions of the State of Ohio. Ohio EPA would like to acknowledge their debt to these agencies, particularly U.S. EPA and the Oregon Department of Environmental Quality.

Ohio EPA would also like to recognize the efforts of the Ecological Risk Assessment Group (ERAG) and staff members who assisted and cooperated with the development of this document:

Bernie Counts  
Brian Tucker (Team Leader)  
Chris Skalski  
Dave Altfater  
Jeff Reynolds  
Jim Sferra

Laurie Eggert  
Lawrence Sirinek  
Sheila Abraham  
Tara Spoon  
Vanessa Steigerwald-Dick

## **ACRONYMS**

ADD	Average Daily Dose ADD <sub>A</sub> - Average Daily Dose by ingestion of Animal matter ADD <sub>P</sub> - Average Daily Dose by ingestion of Plant matter ADD <sub>S</sub> - Average Daily Dose by ingestion of Soil ADD <sub>Total</sub> - Total Average Daily Dose
A <sub>F</sub>	Fraction of the diet that is Animal matter
ARL	Acceptable Risk Level
AUF	Area Use Factor
BAF	Bioaccumulation Factor BAF <sub>I</sub> - Bioaccumulation Factor for Invertebrates BAF <sub>P</sub> - Bioaccumulation Factor for Prey Items
BCF	Bioconcentration Factor
BSAF	Biota-to-Sediment Accumulation Factor
BW	Body Weight
CF	Dry-weight to wet weight Conversion Factor
COEC	Chemical of Ecological Concern
COI	Contaminant Of Interest
COPECS	Chemicals of Potential Ecological Concern
CSM	Conceptual Site Model
CV	Coefficient of Variation
DERR	Division of Emergency and Remedial Response
DO	Dissolved Oxygen
DQOs	Data Quality Objectives
dw	Dry Weight
EDQL	Ecological Data Quality Level
EHI	Environmental Hazard Index
EHQ	Environmental Hazard Quotient
EPC	Exposure Point Concentration
ERA	Ecological Risk Assessment
ERAG	Ecological Risk Assessment Group
ERfD	Ecologically-Based Reference Dose
FESAP	Field Ecological Sampling and Analysis Plan
GIS	Geographic Information System
HEP	Habitat Evaluation Procedures
IBI	Index of Biological Integrity
ICI	Invertebrate Community Index
IRIS	Integrated Risk Information System
K <sub>ow</sub>	Octanol-Water Partition Coefficient
LD <sub>50</sub>	Lethal Dose to 50% of test population
LOAEL	Lowest Observed Adverse Effect Level
LRW	Limited Resource Water
MDC	Maximum Detected Concentration
MI <sub>wb</sub>	Modified Index of Well-Being
NOAEL	No Observed Adverse Effect Level NOAEL <sub>mc</sub> - Modified Chronic No Observed Adverse Effect Level
NOEL	No Observed Effect Level
OAC	Ohio Administrative Code
OEPA	Ohio Environmental Protection Agency
Ohio EPA	Ohio Environmental Protection Agency
ODNR	Ohio Department of Natural Resources



ODW	Ohio Division of Wildlife, division of ODNR
PAHs	Polycyclic (or Polynuclear) Aromatic Hydrocarbons
PBT	Persistent, Bioaccumulative, and Toxic
PCBs	Polychlorinated Biphenyls
P <sub>F</sub>	Fraction of the diet that is Plant matter
RAGS	Risk Assessment Guidance for Superfund
S <sub>F</sub>	Fraction of the diet that is soil
SMDP	Scientific Management Decision Point
SRV	Sediment Reference Value
T&E	Threatened and Endangered
TAL	Target Analyte List
TCDD	Tetrachlorodibenzo-p-dioxin
TCL	Target Compound List
TDS	Total Dissolved Solids
TEC	Threshold Effect Concentration
TUF	Temporal Use Factor
UCL	Upper Confidence Limit
U.S. EPA	United States Environmental Protection Agency
U.S. FWS	United States Fish & Wildlife Service
USGS	United States Geological Society
ww	Wet Weight

# CHAPTER 1

## OVERVIEW

The Ohio EPA Division of Emergency and Remedial Response (DERR) ecological risk assessment (ERA) guidance document provides methodologies, supported by appropriate references, needed to conduct consistent and protective ecological risk assessments. It is hoped that, as discussed in the 13 August 1998, U.S. EPA Ecological Risk Management Guidance document, these ERA guidelines will aid in:

- planning and conducting ecological risk assessments of appropriate scope and complexity necessary to establish exposure levels that are protective of the environment;
- planning and conducting other environmental evaluations useful for developing and screening remedial alternatives; and,
- providing a body of information to enable rational risk management decision making.

ERA has been defined (U.S. EPA 1992) as a process that evaluates the likelihood that adverse ecological effects may occur or are occurring as a result of exposure to one or more ecological stressors. Typically, ERAs are developed within a risk management context to evaluate chemical and non-chemical stressors and support appropriate environmental decision making.

Ohio EPA DERR stresses that, as stated in the 1998 U.S. EPA ERA guidance, all members of the site evaluation team, including risk assessors and risk managers, should discuss and agree upon:

- clearly established and articulated ecological risk management goals;
- characterization of the decisions to be made in the context of the ecological risk management goal; and,
- the scope, complexity and focus of the ecological risk assessment.

A critical initial component of the ecological risk assessment is problem formulation, the process for generating and evaluating preliminary hypotheses related to the ecological effects of chemical and non-chemical stressors. Ohio

EPA recommends a flexible and phased approach to this problem formulation process, such that identified deficiencies can be rectified prior to relevant management decision points.

### OVERVIEW OF THE ECOLOGICAL RISK ASSESSMENT PROCESS

The Ohio EPA DERR ecological risk assessment process consists of the following four levels:

\$ Level I	Scoping
\$ Level II	Screening
\$ Level III	Baseline
\$ Level IV	Field Baseline

Figure #1 illustrates the various levels and sequence of the ERA process.

The levels in the ERA process are designed to streamline and focus any ecological investigations that are necessary, and, at each level, to eliminate sites that do not require further ecological assessments from the ecological risk assessment process. Sites enter the ERA process at Level I and may exit at the conclusion of any level provided the results indicate that minimal ecological risks exist at the site, a remedial alternative is chosen to reduce ecological risks to acceptable levels, or no further action has been approved by Ohio EPA DERR.

Prior to beginning any ERA, the risk assessors should have read and be familiar with the terms, concepts, and approaches discussed in the following framework documents:

- \$ State of Ohio DERR Ecological Risk Assessment Guidance document, Feb. 2003;
- \$ U.S. EPA [Ecological Risk Assessment Guidance for Superfund: Process for Designing and Conducting Ecological Risk Assessments](#), Interim Final, June, 5 1997, EPA 540-R-97-006; and,
- \$ U.S. EPA [Guidelines for Ecological Risk Assessment](#), Final, April 1998, EPA 630-R-95-002F.

This guidance was produced primarily to assist those in conducting ecological risk assessments as part of a Remedial Investigation and Feasibility study (RI/FS). The RI/FS generic statement of work (SOW) ([Generic Statement of Work for Conducting Remedial Investigations and Feasibility Studies](#), Ohio EPA, Division of Emergency and Remedial Response, Remedial Response Program, should be reviewed to ensure that an ecological risk assessment is conducted to support remedial decision making at the Site.

Ecological risk assessments may be conducted for other programs and other types of environmental decision making. The approaches found within this guidance may be acceptable for these programs or processes. The specific requirements for these programs should be reviewed prior to beginning any investigation to ensure that the results of the risk assessment can be used. Contacting the appropriate Ohio EPA personnel is suggested prior to beginning any ecological risk assessment.

The level of effort, detail, and quantity of site data that is required increases as a risk assessment advances from one level to the next. Below is an outline describing the purpose and requirements of each level of an ecological risk assessment.

Figure 1. Ecological Risk Assessment Process.

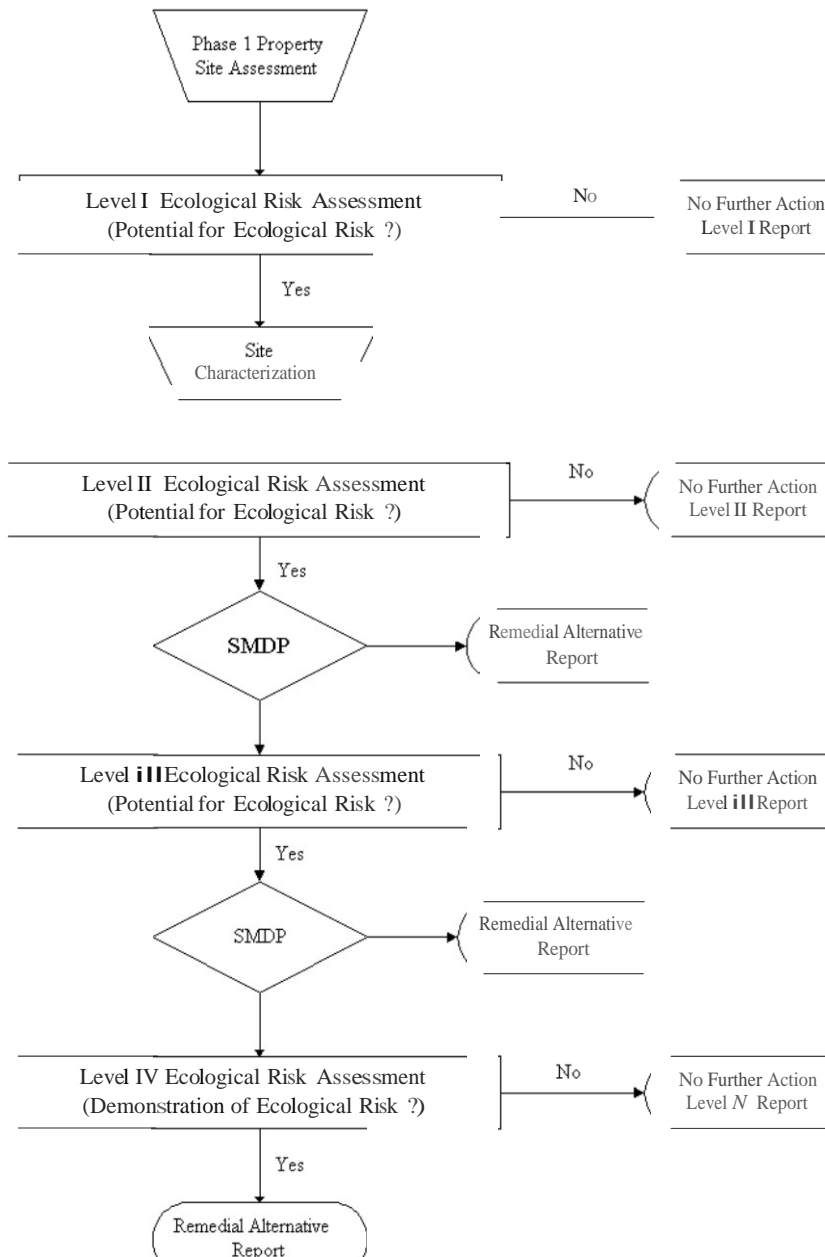

SMDP = Scientific Management Decision Point

### 1.1.1 Level I Scoping Ecological Risk Assessment

The purpose of a Level I ERA is to eliminate sites from further ecological risk evaluation that do not have the potential for current or past release of contaminants of interest (COIs) and non-chemical stressors or, do not contain important ecological resources on or in the locality of the site. The Level I ERA is designed to efficiently determine whether further ecological risk should be evaluated at a particular site. The Level I assessment only requires the results of a Phase I Site Assessment and a site visit/limited field investigation to determine whether or not the site should be evaluated for ecological risks. The following questions are to be answered at the completion of the Level I ERA:

- a) Are current or past releases at the site suspected (use Phase I Site Assessment methodology found in Level I Attachment A)?
- b) Are important ecological resources present at or in the locality of the site?

If the answer to both questions is yes, then the site is subject to continued ecological investigation by completing a Level II ERA. If, however, either of the two questions are answered no, then no further ecological evaluation is required.

### 1.1.2 Level II Screening Ecological Risk Assessment

The purpose of a Level II ERA is to screen the list of detected chemicals per media as appropriate, evaluate aquatic habitats potentially impacted by the site, and if necessary, revise the conceptual site model, complete a list of ecological receptors, identify contaminants of potential ecological concern (COPECs) and non-chemical stressors, and other tasks required for further ecological evaluation of the site and impacted habitats. The Level II ERA is to be completed after the full nature and extent of the site contamination has been determined.

COIs and non-chemical stressors detected in terrestrial habitats (e.g., soil) will be screened

against the appropriate ecotoxicologically-based screening values in a Level II ERA. In addition, concentrations of chemicals in any medium detected on-site may be compared to concentrations representative of background conditions. Background values are to be determined from media samples taken from areas that have not been impacted by site related or other activities that may have negatively impacted the background locations. Sediments may also be compared to the Ohio specific sediment reference values (SRVs) to demonstrate whether surface waters have been impacted by site-related contaminants. Aquatic habitats identified as being impacted by site-related COIs and/or non-chemical stressors, will need to be evaluated using appropriate chemical specific and biological criteria.

The COIs and non-chemical stressors are identified in the Level I ERA due to a history of their use/presence at the site and through the site characterization process following the completion of a Level I ERA. Contaminants of potential ecological concern (COPECs) are simply the COIs and non-chemical stressors remaining after the screening and evaluation procedures of the Level II ERA are completed. COPECs and non-chemical stressors may then be carried through a Level III or Level IV ERA, or a remedial action may be chosen for the site based on the results of the Level II ERA.

A scientific management decision point (SMDP) is offered at the completion of a Level II ERA and any of the following levels of the ERA process. The SMDPs are designed to allow those involved with a site to make a decision for remedial action in lieu of pursuing further ecological evaluations. This decision may provide a cost effective way of eliminating ecological risk and reduce unnecessary ecological evaluation, for instance, when only a limited area requires removal or remediation, or when ecological harm at a site is obvious. SMDPs are made to determine one of three following recommendations:

- § Continue of the ecological risk assessment process at the next level;
- § Undertake a removal or remedial action after completion of site characterization and a Level II ERA, and necessary Agency

- approval has been obtained; or,  
 § No further action.

If ecological stressors in terrestrial habitats are above the screening values, or site-related ecological stressors have been identified in surface water and/or sediments, the following items are to be completed in a Level II ERA:

- a) Identify impacted and exposure media (soil, sediment, surface water, and tissue);
- b) List COPECs (contaminants remaining after the screening process) including non-chemical stressors;
- c) Assess surface water and sediment quality using the Ohio EPA's chemical specific and biological criteria methodology as appropriate.d) Revise the conceptual site model (CSM);
- e) Identify complete exposure pathways;
- e) Identify/list important ecological resources/species (species that are potentially affected) and identify assessment endpoints; and,
- f) Make one of the following scientific management (SMDP) decisions:
  - 1) Move into remedy selection/remedial action, or,
  - 2) continue ecological assessment in a Level III (baseline ecological risk assessment).

### 1.1.3 Level III Baseline Ecological Risk Assessment

The purpose of a Level III ERA is to identify the potential for ecological harm at a site. Specifically, the Level III ERA is a formal ecological risk assessment process that includes an exposure assessment, toxicity assessment, risk characterization, and an uncertainty analysis. Potential ecological hazards are evaluated by using the COPECs and non-chemical stressors identified in a Level II ERA, generic receptors, direct contact evaluations, and food-web models that are provided in the guidance document. The food-web models are used to assess adverse effects caused by the ingestion of contaminated media on the various trophic (feeding) levels identified at the site. The direct contact evaluations are to estimate

adverse effects on terrestrial plants and soil invertebrates. The required direct contact evaluations and food-web models are designed to evaluate the most probable exposures and significant effects that could appear at any site.

The hazard values for ecological receptors should be calculated one time only during the risk assessment process. Site-specific parameters are to be used in the hazard calculations to streamline the evaluation and to ensure that hazard quotient values generated from a Level III ERA reflect possible site conditions and are of such value to be used directly for risk management decisions.

At the conclusion of the Level III ERA three choices are given for a SMDP and include:

- 1) No further action (potential harm to ecological receptors are within the appropriate guidelines);
- 2) Move into remedy selection/remedial action, including risk management; or,
- 3) Continue ecological assessment in a Level IV (field baseline risk assessment) risk assessment.

### 1.1.4 Level IV Field Baseline Ecological Risk Assessment

The purpose of a Level IV ERA is to confirm or refute the findings of the Level III ERA through field and biological measurements. The results of a Level IV ERA are to be used to support a more robust weight-of-evidence determination of possible adverse ecological impacts of site-related ecological stressors.

The Level IV guidance document provides information on choosing the appropriate biological measurements that can aid in the determination of whether the Level III ERA results are consistent with field observations and measurements. Due to the complexity of a Level IV ERA and the variety of issues involved with field/population measurements and evaluation, the Level IV guidance consists of an overview of the process and references additional supporting and guidance documents. The Level IV ERA requires considerable oversight and approval by Ohio EPA. It is

recommended that the appropriate OEPA personnel be contacted once a decision has been made to conduct a Level IV ERA prior to the development of a Level IV work plan.

NOTE: The *Guidance for Conducting Ecological Risk Assessments* is a continuing work in progress and will be updated as needed to reflect major revisions or changes. It is strongly recommended that facilities/responsible parties contact and work closely with Ohio EPA throughout the ecological risk assessment process.

## CHAPTER 2

# LEVEL I – SCOPING

### 2.1 OBJECTIVE

The objective of a Level I (scoping) ecological risk assessment (ERA) is to determine whether there are reasons to believe that an *important ecological resource* is present or potentially present at or *in the locality of the site*, and to investigate the possibility of a release(s) or potential release(s) of an *ecological stressor*. [Note: See definition section in Chapter 6 for all italicized terms.] Scoping is intended to identify sites that are obviously devoid of important ecological resources, and/or where the Phase I Site Assessment indicates that ecological stressors were not potentially released at the site.

Sites that:

- \$ do not have an important ecological resource; or,
- \$ for which there is no reason to believe a release of any ecological stressor has occurred, will not be required to continue the ERA process.

A Level I ERA is intended to focus primarily on habitat and Phase I Site Assessment data (*i.e.*, chemical data from the appropriate media are not required for Level I, although adequately validated data may be factored into the decision-making process, as appropriate). Habitat evaluation is required to determine whether important ecological resources are found on or in the locality of the site.

Habitat is assessed to determine the quality and quantity of the environment, and the likelihood that important ecological resources could be affected by potential releases from a site. Phase I Site Assessment data are used to determine the potential for releases of ecological stressors that may have occurred at a site. Historical data are collected by performing a Phase I Site Assessment as described in Attachment A. The Phase I Site Assessment is designed to evaluate the potential of a release of ecological stressors at or in the locality of the site. In this context, special attention should be paid to the requirement to identify all above and below ground migration conduits associated with the suspected, actual or potential releases. Habitat type(s) and quality, and the potential existence of important ecological resources must also be evaluated and documented by using the Level I methods and checklists attached.

### 2.2 PREREQUISITE

The completion of a Phase I Site Assessment (Attachment A) is required to begin a Level I ERA.

### 2.3 TASKS

The following tasks are to be completed as part of a Level I ERA:

#### 2.3.1 Task 1 Assess Existing Data

When possible, the following information should be obtained prior to the site visit:

- a) Surface area of the site;
- b) Present and historical uses of the site;



- c) Current and potential future land and/or water use(s);
- d) Important ecological resources at, or in the locality of the site;
- e) Known or suspected presence of threatened and/or endangered species, or any state or federal special status species, or their habitat in the locality of the site as evidenced by response letters from: U.S. Fish & Wildlife Service (U.S. FWS); the Ohio Department of Natural Resources (ODNR), Ohio Division of Wildlife (ODW); the Ohio EPA Division of Surface Water (DSW) Ecological Assessment Section; local naturalists, or other information sources. See Attachment E for a list of State and Federally Listed Threatened and Endangered species;
- f) Accurate site and regional maps showing structures, sampling locations (if available), land use, wetlands, surface water bodies, and *sensitive environments*;
- g) Types of ecological stressors potentially released at the site; and,
- h) Biological and Water Quality studies performed by Ohio EPA.

It is also recommended that the public be included where applicable during the initial stages of determining whether important ecological resources are present at, or in the locality of the site. This will help ensure that public concerns regarding what constitutes an important ecological resource have been heard.

### **2.3.2 Task 2 Site Information and Identification of Important Ecological Resources**

A site visit is required to directly assess ecological features and conditions of the site and to determine the presence or absence of important ecological resources. An ecologist or biologist with risk assessment experience should be consulted and conduct the site inspection. The site visit should be conducted at a time of the year when ecological features are most apparent (e.g., spring, summer). Visits during the winter months or periods of severe weather are more likely to produce evidence incorrectly indicating the absence of ecological receptors. The site, and if possible, areas in the locality of the site, should be visited. While at the site, or following the site visit, the following activities should be performed:

- a) Look for any signs (e.g., visual, olfactory) of a chemical release;
- b) Produce a site map (derived from paper maps or from Geographic Information System (GIS) databases) identifying relevant surface features such as water and potential hazardous substances migration pathways, location of buildings, green space etc. Additional maps should be included such as United States Geological Survey (USGS) 7.5 minute quadrangle maps, National Wetland Inventory maps, and National Resource Conservation Service (NRCS) maps, if appropriate, or available;
- c) Note any signs (e.g., visual, olfactory) of hazardous substance migration within the site or offsite;
- d) Look for signs of habitat within or in the locality of the site that could contain or be used by threatened and/or endangered species or other important ecological receptors;
- e) As appropriate, note any signs for groundwater discharge (e.g., seeps, springs) to the surface.
- f) Note any natural or anthropogenic disturbances onsite;
- g) Make a photographic record of the site with emphasis on ecological features and potential exposure pathways. Photographs should also be identified by time, direction, latitude and longitude and identified on a USGS quadrangle map; and,
- h) Complete the Ecological Scoping Checklist (Attachment B).

### **2.3.3 Task 3 Identify Potential Chemical and Non-Chemical Stressors**

Based on the Phase I Site Assessment, summarize any potential chemical and non-chemical stressors that may have been released at the site. Please note that identification of chemical and non-chemical stressors for ecological receptors may necessitate a separate identification process than that used for any

human health evaluation, since a contaminant not generally considered a threat to human health may be a threat to *biota*. When gathering information on potential chemical and non-chemical stressors, the focus should not be solely on hazardous substances. The investigation should also consider whether or not non-chemical stressors, such as mechanical disturbances, abnormal soil/sediment conditions, or other water quality parameters (e.g., elevated total dissolved solids (TDS), low dissolved oxygen (DO), temperature, extremes in pH, etc.), are potentially contributing to adverse ecological effects. These non-chemical stressors should be identified along with the chemical stressors to provide an insight into the general ecological health at and surrounding the site. The results of this evaluation are summarized by completing Attachment B, Part 2.

#### **2.3.4 Task 4 Level I Assessment**

Make an estimate, based on the site-specific information gathered in the previous three tasks and professional judgment, as to whether important ecological resources are, or potentially could be impacted by site related ecological stressors. The evaluation results are summarized by completing Attachment C.

##### **Decision 1: Are Ecological Risks Suspected?**

Based on information gathered in tasks 1 through 3, do important ecological resources exist at or in the locality of the site, and has there been a release or suspected release of ecological stressors? Specific criteria from Attachment C are as follows:

- a) If "Y" or "U" boxes in Attachment C are checked for row **f** and any other row, then a recommendation to move to Level II should be made for an assessment of the appropriate aquatic and/or terrestrial habitat. In completing this Attachment, a lack of knowledge, presence of high uncertainty, or any "unknown" circumstances should be tabulated as a "U".
- b) If all of the "No" boxes in Attachment C are checked, or if only row **f**, or only rows **a** through **e** are checked "No", then the site is highly unlikely to present significant risks to important ecological receptors and a recommendation for no further ecological investigations should be made.

#### **2.3.5 Task 5 Submit Level I Deliverable**

This deliverable is a report (see Attachment D, Level I (Scoping) Ecological Risk Assessment Report, for suggested format and content) detailing the results of the data review, the site visit, the evaluation of the presence or absence of important ecological resources, and the potential releases of ecological stressors. It should present information in sufficient depth to give risk managers confidence in determining whether important ecological resources and uncontrolled ecological stressors are or are not likely to exist at the site.

## **Attachment A**

### **Ecological Phase I Site Assessment**

#### *Purpose of a Phase I Site Assessment:*

The purpose of a Phase I Site Assessment is to determine whether any releases have or may have occurred from on or off-site activities. The Phase I Site Assessment is used to help complete Task 3 of the Level I Ecological Risk Assessment. At a minimum, the Phase I Site Assessment should include a review of the historic and current uses of the site, a review of the complete environmental site history, a review of the history of hazardous substances or petroleum release history, and a site inspection.

Much of the site history and contaminant release information needed for the ecological phase 1 site assessment can likely be found in the preliminary investigation/site assessment (PI/SA) as part of the RI/FS process, or from the Voluntary Action phase 1 assessment. These resources should be evaluated prior to beginning any assessment at a site.

#### *The Phase I Site Assessment Investigation:*

##### Historic And Current Uses

The purpose of exploring the historic and current uses of the site is to establish a continuous site history, from the first industrial or commercial use through the present use. A diligent inquiry of reasonably available historical sources should be made to determine this information. A chain of title investigation using deeds, mortgages, easements of record, and other similar documents that are reasonably available should help establish a history of previous ownerships. Interviews with people who were employed or resided near the site may help identify past uses of the site.

##### Environmental History Review

This section of the assessment should provide the environmental site history to determine areas suspected of hazardous substance or petroleum management, treatment, storage or disposal, and areas where a release may have occurred. This section should include any previous environmental assessments or studies, property or site assessments and/or geologic studies of the site.

An investigation of the environmental compliance history of the site should be made for both current and past owners or operators. This information can be obtained from U.S. EPA, Ohio EPA, the Ohio Department of Natural Resources (ODNR), and the Bureau of Underground Storage Tank Regulations (BUSTR). Specifically, the following sources may help locate information on environmental compliance history: Federal National Priorities List (NPL), Federal Comprehensive Environmental Response, Compensation, and Liability Information System list (CERCLIS), Federal Resource Conservation and Recovery Act (RCRA) treatment storage and disposal facility list, Federal RCRA generators list, Federal emergency release notification system list, RCRA Info data base (RCRIS), Ohio EPA Division of Hazardous Waste Management (DHWM) files, Ohio EPA Division of Emergency and Remedial Response (DERR) files, Ohio BUSTR registered Underground Storage Tank (UST) list, Ohio BUSTR leaking UST list, Ohio EPA spill data base, ODNR well log information, Community Right-to-Know inventory report records of the State Emergency Response Commission or the Local Emergency Planning Committee, local fire department records, and local health department records. Other federal, state and local agency records and databases, such as those referenced in ASTM Standard E 1527, paragraph 7.2.2, may also help locate additional information. Lastly, interviews with people who were employed or resided near the site may help identify areas that were used for hazardous substance or petroleum management, treatment, storage or disposal, and areas where releases occurred.

A review of these sources should also be conducted on areas surrounding the site to determine if releases from adjoining properties may have migrated onto the site. If information from this search indicates such releases may have occurred, then a "Site Hazardous Substance or Petroleum Release History" review should be performed for these sites as well, to the extent practicably reviewable.

### Site Release History

The purpose of this portion of the Phase I Site Assessment is to identify all known or suspected contaminant releases that have or may have occurred on-site or off-site. Specifically, the Phase I Site Assessment should identify, to the extent known or suspected: the contaminant type, the quantity, the date of release, the areas of the site impacted by the release, the media impacted, and any measures taken to address the release, including the result of those measures.

### Site Inspection

The purpose of a site inspection is to determine whether any releases have or may have occurred by a physical inspection of the site. A physical inspection of the interior and exterior of all buildings and structures on the site and an inspection of all other areas should be conducted. When conducting the site inspection the following areas should be identified and documented: underground storage tanks, above-ground storage tanks, wells (including oil and gas wells and underground injection control wells), cans, boxes and other containers, pipes, drains, storm or sanitary sewers, electrical equipment, cables, fuel tanks, oil pans, lagoons, stacks, cooling systems, inventory, pits, piles, landfills, waste or process water treatment systems, equipment and associated structures that contain or previously contained any hazardous substances or petroleum, and areas used for the treatment, storage, management or disposal of any hazardous substances or petroleum.

If any of these sources are identified in the site inspection, the condition of the sources should be documented. Evidence of a release at these sources or any other areas of the site should be noted. Such evidence includes stressed vegetation, spilled materials, discolored soils, or a strong, pungent or noxious odor. Also, any identifiable migration conduits for hazardous substances or petroleum, such as basements, drains, tiles, wells, and utility lines should be documented. Evidence of current and past uses of adjoining properties which may be observed from the site or which are accessible from public rights of way should be included in this section.

Lastly, the general physical condition of the site should be noted. The general topographic conditions of the site and areas surrounding the site should be noted. Any physical obstructions which limit the visibility of conditions on the site, including but not limited to buildings, snow or leaf cover, rain, fill, asphalt, or pavement, should be included in this section.

### *The Phase I Site Assessment Report:*

#### Introduction

The introduction should identify the site and include the legal description of the site. The introduction should also include the date that the Phase I Site Assessment and the written report were completed, the name and job title of each person conducting the investigation, and a summary of the current and intended use of the site.

#### Identified Areas

The Phase I Site Assessment should identify each area located on or underlying the site which has contained hazardous substances or petroleum at some point in the history of the site. In addition, this section should also identify any area where a release has or may have occurred. If there is reason to believe a release has or may have occurred, but it cannot be visually observed or otherwise defined, then it is necessary to designate as an identified area that portion of the site suspected to be affected by the hazardous substances or petroleum. If it is known that a release of hazardous substances or petroleum occurred on the site but there is no information on the location of the release, then the whole site may be designated as one identified area.

#### Conclusions

The conclusion section should discuss whether there is any reason to believe that any releases have or may have occurred. If there is any reason to believe that any releases have or may have occurred, the report should identify the hazardous substances or petroleum as Contaminants of Interest (COIs) and

identify the areas where these COIs are known or suspected to be present. [Note: Any of the areas and/or COIs identified in the Phase I Site Assessment report may be redelineated or eliminated as a result of additional data collected during the Level I and/or Level II Ecological Risk Assessment.]

### Maps

A number of maps should accompany the Phase I Site Assessment report, including: a site location map using the most currently available 7.5 minute USGS topographic map; a site map which identifies significant structures and features, including property lines; a site map which labels the identified areas, and the locations of all known or suspected releases on the site; and a map which identifies all areas surrounding the site which were identified in the "Environmental History Review" as areas that were used for hazardous substance or petroleum management, treatment, storage or disposal. The Phase I Site Assessment should provide latitude and longitude coordinates for the site, and a digitized map should be included, whenever possible.

### Review Methodology

This section should include an explanation of all procedures used during the Phase I Site Assessment. This section should also include a summary of all relevant information used to meet the objectives of the Phase I Site Assessment Investigation, including: historic and current uses of the site, adjoining properties, and areas surrounding the site; the environmental history review; the release history on or adjoining the site; any interviews conducted and any site inspections performed.

### Statement of Limitations

This section should include a statement of any limitations or qualifications which impacted the Phase I Site Assessment, including an identification and explanation of any sources of information which were not reviewed because they were not public ally available, practicably reviewable or otherwise reasonably available.

### Bibliography

The bibliography should include any references which identify, to the extent available, a description, date, source, and location of any document reviewed as part of the Phase I Site Assessment, including the name, address and telephone number of any persons interviewed.

### Photographs

Sufficient color photograph documentation should establish the site's current condition, the season and weather conditions during the site inspection, and any significant findings discovered during the site inspection. Documentation should include the date that the photograph was taken and a description of the photograph, such as the specific location and direction.

### Appendices

The appendices should include all appropriate supporting documentation.

### Signed Statement

This section should include a signed statement by the owner/operator or duly authorized representative that performed the Phase I Site Assessment, verifying that: all information is complete and reliable; all of the items outlined in "Phase I Site Assessment Investigation" have been performed to the extent practicably re-viewable; and all activities in the "Phase I Site Assessment Investigation" section have either been performed within 180 days prior to Ohio EPA DERR receiving the assessment, or that subsequent time and/or investigation has not altered the conditions at the site since these activities were performed.

*Definitions:*

For the purposes of this appendix:

“Areas surrounding the site” means all areas located within one half-mile of the property boundaries.

“Diligent inquiry” means conducting a thorough search of all reasonably available information, and making reasonable efforts to interview people with knowledge about the current and past uses of the site, waste disposal practices, and environmental compliance history.

“Historical sources” means sources of information which help in identifying current or past uses or occupants of a site, such as: aerial photographs, fire insurance maps, property tax files, recorded land title records, United States Geological Survey (USGS) 7.5 minute topographic maps, local street directories, building department records, zoning or land use records.

“Practicably reviewable” means information provided in a form that, upon examination, yields information relevant to the site. Records that cannot feasibly be retrieved by reference to the site location, geographic area in which the site is located, or the name of the owner or operator of the site are not practicably reviewable.

“Publicly available” means the source of the information allows access to the information by anyone upon request.

“Release” means a release of hazardous substances and/or petroleum on, underlying, or emanating from a site including, but not limited to, any release from management, handling, treatment, storage, or disposal activities.

**Attachment B Ecological Scoping Checklist**

Part 1			
<b>SITE INFORMATION</b>			
Site Name: _____		Date: _____	
Personnel: _____ _____		Time Arrived: _____	
(Identify team leader)		Time Departed: _____	
Site Address: _____			
Site Location:	Latitude:	Longitude:	
Site Size (acres): _____			
Weather Conditions (note any unusual conditions):          			
Land uses at and adjacent to the site: (Circle all that apply and record at or adjacent)			
Residential	Commercial	Recreational	Industrial
Agricultural	Urban	Green-Space/ Undeveloped	Other: _____

Note: This checklist provides a suggested format. The format may be altered to fit the needs of the site; however, all pertinent information should be presented.





Part 3	
<b>SPECIFIC EVALUATION OF ECOLOGICAL RECEPTORS/HABITAT</b>	
Terrestrial – Wooded _____% of site  Dominant vegetation (circle one): Coniferous      Deciduous      Mixed  Dominant tree diameter diameter at breast height ( <i>dbh</i> ): _____(inches)  Evidence/observation of wildlife*: _____ _____ _____	Terrestrial - Shrub/scrub/grasses _____% of site  Dominant vegetation (circle one): shrub/scrub      grasses  vegetation density: Dense, Patchy, Sparse Prominent height of shrub/scrub (<2', 2' to 5', >5') Prominent height of grasses/herbs (<2', 2' to 5', >5') Evidence/observation of wildlife*: _____ _____ _____
Terrestrial - Ruderal/Engineered _____% of site  Dominant vegetation/surfaces (circle one): Landscaped      Agricultural      Bare ground Parking lot      Artificial surfaces Dominant vegetation height ( 0', >0' - 2', 2' - 5', >5') Vegetation Density: Dense      Patchy      Sparse Evidence/observation of wildlife*: _____ _____ _____ _____	Aquatic - Non-Flowing (Lentic) _____% of site  Type:    Lake    Pond    Vernal Pool    Lagoon Engineered**    Impoundment    Reservoir Water source:    Surface water    Groundwater Industrial discharge      Surface water runoff Discharge Point:    Surface water    Groundwater Wetlands Bottom Substrate***: _____ Vegetation: Submerged    Emergent    Floating Wetland Present: (Yes/No) Evidence/Observation of wildlife*: _____ _____ _____ _____
Aquatic - Flowing (Lotic) _____% of site Aquatic Life Use Designation (if available) _____ Type:    River    Stream    Intermittent Stream Ditch Water source:    Surface Water    Ground Water Industrial discharge      (seeps /springs) Storm water runoff Discharge Point:    Surface water    Groundwater Wetlands      Impoundment Bottom Substrate***: _____ Vegetation: Submerged    Emergent    Floating Wetland Present: (Yes/No) Evidence/Observation of Wildlife*: _____ _____ _____ _____	Aquatic - Wetlands _____% of site Size _____(acres) Obvious or designated wetland: (Yes / No) Water source:    Surface Water    Ground Water Industrial discharge      Surface water runoff Discharge Point:    Surface water    Groundwater Wetlands      Impoundment Bottom Substrate***: _____ Vegetation: Submerged    Emergent    Floating  Evidence/Observation of Wildlife*: _____ _____ _____ _____

\* Wildlife includes: macroinvertebrates, reptiles, amphibians, birds, mammals and fish.  
 \*\* Engineered can mean any surface water body that has been artificially created or significantly altered.  
 \*\*\* Bottom substrate types include but not limited to: cobble, gravel, sand, silt, clay, muck, artificial (e.g., concrete).



## Attachment C

<i>EVALUATION OF POTENTIAL ECOLOGICAL HARM</i>		<b>Y</b>	<b>N</b>	<b>U</b>
Are ecological stressors present or potentially present in:				
a	Soil			
b	Surface Water			
c	Sediment			
d	Groundwater			
e	Other (biotic media)			
f	Are important ecological resources located at, or in the locality of the site?			

"Y" = yes; "N" = No, "U" = Unknown (counts as a "Y")

When answering the above questions, consider the following:

- Known or suspected presence of ecological stressors stored, used or manufactured at the site.
- Ability of ecological stressors to migrate from one medium to another.
  - The mobility of the various media.
  - Transfer of contaminants through food webs and uptake of chemicals by organisms.
  - The presence of important ecological resources, including surface waters on or in the locality of the site.

- (a) If "Y" or "U" boxes in Attachment C are checked for row f and any other row, then a recommendation to move to Level II should be made for an assessment of the appropriate aquatic and/or terrestrial habitat. In completing this attachment, a lack of knowledge, presence of high uncertainty, or any "unknown" circumstances should be tabulated as a "U".
- (b) If all of the "No" boxes in Attachment C are checked, or if only row f, or only rows a through e are checked "No", then the site is highly unlikely to present significant risks to important ecological receptors and a recommendation for no further ecological investigations should be made.

**Attachment D**  
**Level I Deliverable - Level 1 (Scoping) Ecological Risk Assessment Report**  
**Outline**

- (1) EXISTING DATA SUMMARY
  - (a) Site location (Part 1, Attachment B)
  - (b) Site history (Summary from Phase 1 Site Assessment)
  - (c) Site land and/or water use(s)
    - (i) Current
    - (ii) Future (list reasonable potential uses)
  - (d) Known or suspected hazardous substance releases
  - (e) Threatened and/or endangered species (USFWS/ODNR/DOW data)
  
- (2) SITE VISIT SUMMARY
  - (a) Contaminants of Interest (Part 2, Attachment B)
  - (b) Ecological features (Part 3, Attachment B)
  - (c) Ecologically important species/habitats (Part 4, Attachment B)
    - (i) Threatened and/or endangered species
    - (ii) Threatened and/or endangered species habitat
  - (d) Exposure pathways (Attachment C)
  
- (3) RECOMMENDATIONS
  
- (4) ATTACHMENTS
  - (a) Regional map showing location of site
  - (b) Local map showing site in relation to adjacent property
  - (c) Site map
  - (d) Sketch/develop a map of ecological features as an overlay to the site map or as a separate map.
    - (a) Sketch/develop a map of known or suspected extent of hazardous substances as an overlay to the site map or as a separate map
  - (f) Summary of Phase I Site Assessment report
  - (g) Site photograph(s)
  - (h) Copies of letters to and from USFWS and ODNR, responding to queries about threatened and endangered species
  
- 5) REFERENCES / DATA SOURCES

**Attachment E**

Division of Wildlife  
Ohio Department of Natural Resources

Please see: Division of Natural Areas and Preserves, Ohio Department of Natural Resources at: <http://ohiodnr.com/default/tabid/867/Default.aspx>, for additional and up-to-date information about threatened and endangered plant species, and <http://ohiodnr.com/Home/ExperienceWildlifeSubHomePage/Endangeredthreatenedspeciesplaceholder/resourcesmgtpplansspecieslist/tabid/5664/Default.aspx> for listings of animal species. Please note that the links for the specific information above may change. The home page for Ohio DNR can be found at: <http://ohiodnr.com/>

## CHAPTER 3

# LEVEL II -SCREENING

### 3.1 OBJECTIVE

The objective of a Level II ERA is to compare site-specific data to the Ohio Water Quality Standards, Ohio sediment reference values (SRVs), and other values identified in this document to determine the need for further ecological evaluation of a site. If all concentrations of site-related ecological stressors are below the appropriate screening concentrations, in all relevant media, and surface waters are meeting applicable criteria, then the entire site is considered to have minimal impact on important ecological resources and no further ecological assessment is necessary. However, if any site-related ecological stressor concentration is not meeting the applicable value, then the site is required to continue the ecological assessment in a Level III ERA, or the information is used to complete a remedial or other appropriate risk management alternative.

Furthermore, the process of the Level II ERA is designed to:

- a) evaluate site-specific chemical concentrations and attainment of Ohio Water Quality Standards (Tasks 3 and 5);
- b) characterize wetlands at or in the locality of the site using [Ohio EPA's Rapid Assessment Method for Wetlands](#);
- c) identify contaminants of potential ecological concern (COPECs) from among the contaminants of interest (COIs) associated with the site and identified during the Level I ERA and site characterization process;
- d) update the site description based on information from site visits and/or surveys, the existing literature, any prior preliminary assessments, and site history (including past and present uses) (Task 8);
- e) revise the conceptual site model (Task 9);
- f) identify site-specific ecological receptors (Task 10);
- g) identify relevant and complete exposure pathways between each source medium of concern and site-specific ecologically important receptors (Task 11);
- h) define ecologically appropriate assessment endpoints (Task 12);
- i) scientific management decision point (Task 13); and,

- j) summarize the appropriate information in a Level II report (Task 14).

Activities b through h (Tasks 6 through 13) are only required after the screening process (Tasks 4 and 5) when chemicals are retained as COPECs or non-attainment of the Ohio Water Quality Standards exist at, or in the locality of the site. All sites conducting a Level II ecological risk assessment are required to submit a Level II report (Task 14).

### Level II Flowchart and Legend (Attachment A)

The Level II guidance includes a flowchart and legend (Attachment A) that is hoped, will be beneficial to the reader to determine the appropriate methodologies for evaluating potentially contaminated media. The flowchart guides the reader through the procedures contained within the Level II guidance. The flowchart begins with site characterization which is completed between the Level I and the Level II ecological risk assessments. The flowchart should be used in conjunction with the written text of the Level II guidance. The Level II guidance makes several references to the flowchart to help identify various steps of the flowchart with the corresponding sections of guidance text.

### 3.2 PREREQUISITES

A release or suspected release, of ecological stressors and the identification (completion of Level I ERA) of important ecological resources on or potentially influenced by the site is required to begin a Level II ERA. In addition, the determination of the nature and extent of contamination (*i.e.*, site characterization) is also required before the Level II ecological assessment can be undertaken.

### 3.3 TASKS

The following are to be completed as part of a Level II ERA:

#### 3.3.1 Task 1 Evaluate Existing Site Data

If the results from the Level I (Scoping) ERA

efforts indicate important ecological resources are associated with the site, and evidence exists that ecological stressors may have been released at the site, then site characterization is required.

If sufficient chemical data from ongoing activities exist to satisfy the site characterization data needs, further data collection may not be required for the completion of a Level II ERA. It should be noted that sites with impacted lotic surface water or sediment will generally be required to conduct biological criteria investigations to determine compliance with Ohio Surface Water Standards [Ohio Administrative Code (OAC) 3745-1]. The collection of data needed for conducting the biological evaluation has both technical and seasonal considerations that should be reviewed prior to conducting the site characterization process.

### **3.3.2 Task 2 Site Characterization**

Site characterization is completed prior to the Level II ERA process. This collection and evaluation of data may be iterative and is completed as part of the site RI. Please refer to the RI/FS generic or site specific SOW for the Site. Other processes may be followed for site assessment, as appropriate for the specific program being utilized for the site or property. The following information is provided to assist the development of the site characterization sampling plan.

#### **A) Sampling**

Sampling should be designed and conducted to determine the full nature and extent of potential contamination. Sampling may also be completed to be representative of possible exposure units. Chemical sampling and analysis of non-chemical stressors, provides data concerning the presence or absence of COIs and their concentrations in abiotic media (*i.e.*, soil, surface water, ground water, and sediment). Sampling of aquatic organisms (*e.g.*, macroinvertebrates and fish) to document the attainment of the Water Quality Standards of Ohio may also be required. Non-chemical stressors should be evaluated when impacts caused by these stressors are expected (see Task 6). Sampling should cover all relevant media of ecological interest. Analytical detection levels are to be low enough to be of ecological

significance (*e.g.*, lower than the screening values), as determined by the analysis plan (which includes Data Quality Objectives (DQOs) and a Quality Assurance/Quality Control (QA/QC) plan). [Note: A consistent sampling approach and methodology for site evaluation is envisioned for the site characterization process that when needed will result in data sufficient for conducting both human health and ecological risk assessments.]

#### **B) Calculate COI Concentration(s)**

For the Level II screening assessment, maximum detected values of chemical concentrations in soils and sediment are to be used to compare to the appropriate screening values. Surface water COI concentrations, when used to compare to water quality criteria, are specified in OAC 3745-01.

Use of a geographic information system (GIS) is suggested to overlay the spatial distribution of various habitat types with contaminant distributions. This information would be useful for identifying potential ecological receptor species and habitats if contamination is present at a site. GIS information and support may be available from the Ohio EPA DERR. Please contact the DERR to determine if data and support are available for the site of interest.

### **3.3.3 Task 3 Data/Media Evaluation**

COIs (identified in Level I, site characterization, and quantified in Task 2 and 3 of Level II) in all appropriate media are evaluated on the basis of physicochemical properties and/or toxicity [see Step B of the flowchart (Attachment A)]. The Data/Media evaluation is comprised of two processes: A) Data Evaluation, a process used to screen chemicals from the risk assessment by using a frequency of detection screen and to eliminate common laboratory contamination, and B) Media Evaluation, which is a process to determine if site-related chemicals have impacted media associated with a site.

#### **A) Data Evaluation**

(i) Frequency of Detection COIs that are

detected infrequently may be artifacts in the data due to sampling, analytical, or other errors. COIs detected in five percent or less of the samples for a given medium need not be selected as COPECs, assuming that the detection limits were low enough for ecological purposes and that adequate sampling has occurred in all relevant media. A detection frequency of five percent or less is usually considered grounds for eliminating a chemical from further consideration. A COI should however be retained if it is exceptionally toxic to ecological receptors, measured at high concentrations, is a persistent, bioaccumulative, and toxic (PBT, see 3.3.5 (C)) compound, identified in multiple media, or located in sensitive environments.

- (ii) Common Laboratory Contaminants  
Blank data should be compared to the corresponding field samples from which the blanks are associated. This will provide a measure of contamination that has been introduced into the samples during sample preparation or analysis. Acetone, 2-butanone (or methyl ethyl ketone), carbon disulfide, methylene chloride, toluene, and phthalate esters are considered to be common laboratory contaminants. If blanks contain detectable levels of common laboratory contaminants, then the sample results should be considered as positive results only if the concentrations in the samples exceed ten times the maximum amount detected in any blank. For those chemicals which are not common laboratory contaminants, the chemical should be retained for further evaluation if the maximum sample concentration is greater than five times the maximum blank concentration.

## B) Media Evaluation

The media evaluation step is used to determine whether site-related stressors have impacted media associated with the site. The evaluation method is dependent upon the medium in question. Below are the acceptable methods for media evaluation.

- (i) Background Concentration

Ecological stressors detected on-site may be compared to concentrations representing background levels. Background levels can be determined for soil, surface water, and sediment. Chemicals and media may be eliminated from further investigations provided on-site concentrations of ecological stressors are comparable to background conditions (see 3.3.5 (C) on PBT compounds).

*Background* is defined as the quantity of naturally occurring chemical and non-chemical stressors at a site and areas surrounding a site, that have not been affected by any current or past activities involving the management, handling, treatment, storage or disposal of ecological stressors. If a site-related compound is comparable to the selected background concentration (e.g., maximum detected concentration (MDC) of a COI is less than the concentration selected as a background value), then that COI need not be selected as a COPEC. Furthermore, media samples for background concentrations are to be from environments that have not been impacted by site related or other contaminating activities. To help ensure media samples were taken from the appropriate background locations, background samples may be analyzed for target analyte list (TAL) and target compound list (TCL) chemicals. The results should indicate whether background locations have been impacted by site-related or other activities. Caution is recommended for anthropogenic compounds detected in locations considered to be background. Additional scrutiny of the data is recommended to ensure that background locations have not been impacted by site related activities. Methods for calculating background values can be found at: <http://www.epa.ohio.gov/portals/30/rules/bground%20guidance.pdf>.

For surface water and sediment screening, the background evaluation is not intended to determine relative amounts or up-stream sources of contamination. The background screening step is intended to determine if sediment or surface waters have been



impacted by site related stressors and to eliminate specific compounds or entire media if chemical concentrations are indicative of background conditions.

Background conditions for all surface water bodies can be measured on a site specific basis. Sediment background concentrations from lotic (flowing) surface water bodies may be derived from on-site sampling or selected from the appropriate Ohio specific sediment reference values (SRVs), (see 3.3.3 (B)(ii)). If chemical concentrations in depositional sediments indicate background conditions, then the sediments may be eliminated from further ERA procedures and the results are to be provided in the Level II report. If ecological stressors in sediment are detected above background or SRV concentrations, then the sediments are considered impacted or potentially impacted by site related compounds and are subject to the Ohio surface water statutes, which include chemical and biological criteria where appropriate. See section 3.3.5 (B) for details regarding the evaluation of contaminated sediment and surface water bodies.

(ii) Ohio Specific Sediment Reference Values

Sediment concentrations from lotic surface water systems may be compared to the Ohio specific sediment reference values. [Note: Sediments from lentic environments may be evaluated using SRVs upon approval.] The SRVs, found in Attachment H, can be used in lieu of site-specific background concentrations for sediments for determining whether sediments have been impacted by site related activities. If the on-site sediment concentrations approximate reference conditions (e.g., the maximum detected concentration of a COI is less than the corresponding SRV), then sediment is not retained as an exposure medium in the Level II ERA. If SRVs do not exist for certain chemicals detected in sediment, then those chemicals can only be eliminated by being detected at concentrations less than or equal to site specific background values (see 3.3.3 (B)(i)). Sediment associated COPECs can

be narrowed further in tasks 5 and 6 where appropriate.

The media evaluation step is designed so evidence may be gathered that reasonably demonstrates that specific media at a site may not have been impacted by site-related compounds. This evidence may include up-stream and background, chemical concentrations, topographic, and other information that demonstrates or explains why site-related compounds have not migrated from one medium to another. For example, if a site can demonstrate that no releases have occurred and there is little potential for future releases to surface water then, sediments and surface water can be eliminated as exposure media in the ecological risk assessment. The sampling results and rationale used for eliminating any medium in the ecological risk assessment is to be given in the Level II report. An example of how surface water and sediments may be dismissed from further evaluation is as follows:

It was determined that a site has localized soil contamination, found only in the vicinity of a building, and that the contamination has not migrated to a nearby surface water body. Soils down-gradient and adjacent to the surface water body are not impacted. Site related compounds were not detected in sediments or were detected at or below the Ohio specific reference values or upstream concentrations.

### 3.3.4 **Task 4 Scientific Management Decision Point (SMDP)(removal)**

A scientific/management decision point (SMDP) is offered for sites with limited soil or sediment contamination of lentic or lotic water bodies designated as limited resource water (LRW) by the Ohio EPA, Division of Surface Water. A site may choose to remove contaminated media in lieu of completing an ecological risk assessment. If site contamination has been identified, important ecological resources are at or in the locality of the site, and a remedy other than contaminant removal is desired, then the ecological risk assessment process is to continue onto Task 5.

The SMDP (removal) option is offered to allow for removal of contaminated soil to background levels. Sediment contamination may also be removed for lentic or LRW designated surface water bodies. Specifics on how any removal may be completed and any potential impacts caused by the action are to be evaluated as required by the remedial (e.g., RI/FS, removal action carried into the feasibility study (FS) or voluntary process being completed). The SMDP (limited) option offered as part of Task 4 is only available for removal actions and would require the removal of contaminated media. The use and applications of the other SMDPs are discussed in Task 13 of the Level II guidance.

Task 4 (SMDP) is also the termination point of the ecological risk assessment process if all media concentrations of site-related chemical and non-chemical stressors are indicative of background conditions. If through the data and media evaluation step (Task 3) all compounds have been eliminated, then the Level II ERA can be completed by finalizing the Level II report.

### 3.3.5 **Task 5 Media Screening**

The media screening process is to be conducted if following the site characterization and data/media evaluation, a decision is made to continue with the ecological risk assessment process instead of selecting a removal option (Task 4). The screening process is dependent on the media that have been retained due to the possibility of site-specific contamination. If stressors detected in any media are below their appropriate and available screening values, then those stressors may be eliminated from further ecological risk evaluations. If all of the stressors detected in any given medium do not exceed the appropriate screening values, then the entire medium may be eliminated from future ecological risk evaluations. Chemicals detected in various media may be screened according to the following procedures:

#### A) **Soils**

Soil found to be potentially impacted (e.g., ecological stressors were detected at concentrations greater than background) may be screened using toxicologically-based benchmark

values (see steps E through H of the Level II flowchart, Attachment A). The maximum soil concentrations are to be used for the comparison of site related chemicals to benchmark values. Chemicals with maximum concentrations found to be greater than the benchmark values are to be retained as COPECs and reported in the Level II Report. Chemicals with maximum concentrations below the cited benchmark values may be eliminated from further ecological evaluation. If only minor exceedances are detected and other evidence can substantiate, a claim may be made that some or all of the site-associated soils have not been impacted and no additional ecological investigation of the soils is warranted. This information is to be presented in the Level II Report.

The soil screening value hierarchy is to be used in finding the appropriate screening values for soils, and is to be used in the order given in the guidance.

#### Soil Screening Hierarchy:

- 1) U.S. EPA ecological Screening Levels (Eco-SSL) <http://www.epa.gov/ecotox/ecossil/>
- 2) Preliminary Remediation Goals for Ecological Endpoints, Efroymson, R.A., G.W. Suter II, B.E. Sample, and D.S. Jones, August 1997, ES/ER/TM-162/R2, Oak Ridge National Laboratory, Oak Ridge, Tennessee 37831, <http://www.esd.ornl.gov/programs/ecorisk/documents/tm162r2.pdf>.
- 3) Ecological Screening Levels, U.S. EPA, Region 5, 2003. <http://www.epa.gov/reg5rcra/ca/edql.htm>

#### B) **Surface Water and Sediment Evaluation**

The evaluation of sediment and surface water is dependent on the type of surface water(s) that is affected. Surface water is classified as either lotic (flowing) or lentic (not flowing). The distinction between water bodies is based on the fact that biological criteria are not available for lentic waters in OAC 3745-1 or lotic waters designated as Limited Resource Waters (LRW) in accordance with section OAC 3745-1.

Lotic water bodies designated warmwater, exceptional warmwater, and modified warmwater habitat have specific biological criteria associated with the designations (OAC 3745-1-07). Aquatic life habitat use designations for these designated water bodies are listed in OAC 3745-1-08 through 3745-1-30.

Lotic water bodies that have not been designated will need to be designated prior to completing the ecological evaluation or criteria for warm water habitat may be applied to the water body. See 3.3.5 (B)(ii)(b) for the designation process for surface water bodies. In the Level II flowchart, step I is the beginning point for the evaluation of surface water and step M is the beginning point for sediment. The following procedures for evaluating surface waters and sediments for a Level II ERA are divided into lentic/LRW and lotic systems and are to be used accordingly:

(i) Surface Water

Surface water chemical concentrations are to be compared to the chemical criteria pursuant to OAC 3745-1. The outside mixing zone average criteria for human health and aquatic life should be compared against ambient samples averaged over a 30-day period. Single ambient samples are not to exceed the outside the mixing zone maximum. If all chemical constituents are below their corresponding chemical criteria, then the surface water may be eliminated as an exposure medium. An updated summary of chemical criteria can be found at: <http://www.epa.ohio.gov/dsw/wqs/criteria.aspx>. Biological criteria corresponding to the aquatic life habitat designation of the water body are to be in full attainment (see 3.3.5 (B)(ii)(b) below).

(ii) Sediment

The sediment screening/evaluation process is specific for the type of water body being investigated. Sediment evaluation begins at step M of the Level II flowchart. Below are the procedures for evaluating sediments based on the surface water type:

a) Lentic Surface Water/LRW Designated Lotic Surface Water

Sediment concentrations for lentic/LRW surface water bodies can be screened using the values prescribed in the sediment

screening hierarchy listed in section 3.3.5 (B)(ii)(d). Maximum sediment concentrations are to be compared to the screening benchmark values. If sediment chemical concentrations are at or below the appropriate screening benchmark values, then the chemicals may be eliminated from further investigation. If all chemicals are at or below the appropriate screening benchmark values, and screening benchmark values exist for all chemicals, then sediment may be eliminated as an exposure medium in the ERA. Chemicals that exceed screening benchmark values, or where screening values are not available in the hierarchy, are to be retained as COPECs (Task 6) and listed in the Level II report (Task 14).

b) Lotic Surface Water

Lotic surface water must meet chemical and non-chemical specific criteria and be in full attainment of the aquatic life habitat use designation criteria listed in OAC 3745-1. If a lotic surface water system has not been designated in the OAC, the assessors are to contact Ohio EPA Division of Surface Water for information regarding the designation of the water body. It is possible that data and proposed designations are available on lotic surface water systems that have not been codified in the OAC. If a lotic surface water system has not been designated in the OAC and Ohio EPA has not recommended a use designation, then the criteria for warm water aquatic life habitat use designation apply. Site specific data may also be collected to determine the appropriate designation of the water body. Ohio EPA is to be contacted for specific procedures and the level of effort required to adequately designate a surface water body. Once a lotic stream has been designated, the attainment status of the biological criteria can be determined. Lotic surface water bodies are to be in full attainment of their aquatic life use designations. If only partial or non-attainment of the aquatic life use designation is met, then further evaluation may be required.

Pertinent information explaining the reasons why a section is not in full attainment can be given in the Level II report. If physical degradation of the aquatic habitat, urban development, or reasons other than site related contamination can adequately explain

the failure of a site to be in full attainment of the aquatic life use designations, then further ecological evaluation (*i.e.*, Level III or greater ERA) may not be required. If however, a site is not in full attainment of the aquatic life use designation(s), and any site-related chemical contamination has been identified in sediment or surface waters, then continued ecological evaluation (Level III or greater ERA), remediation, or other remedial actions will be required.

Sediment contaminant concentrations from streams that are not in full attainment of the aquatic life habitat use designations, or do not exceed the non-significant departure of the aquatic life habitat use designation (see definitions section), are to be compared to the values cited in the sediment screening hierarchy in 3.3.5 (B)(ii)(d). Chemicals that exceed the sediment screening benchmark values are to be retained as COPECs and

listed in the Level II report.

c) Wetlands

Wetlands are to be treated as lentic/LRW surface water for the evaluation of sediments. Sediment substrates are to be compared to the sediment screening values given in section 3.3.5 (B)(ii)(d).

Surface waters associated with wetlands are to meet the surface water chemical specific criteria where appropriate. Surface water chemical criteria are discussed in 3.3.5 (B)(i). Ohio EPA should be contacted with any specific questions regarding the evaluation wetland media (surface water or sediment/substrate).

d) Sediment Screening Hierarchy:

Below is the hierarchy for obtaining sediment screening values:

- 1) Consensus-based TEC values;  
The TEC values are located in: Development and Evaluation of Consensus-based Sediment Quality Guidelines for Freshwater Ecosystems, D.D. MacDonald, C.G. Ingersoll, and T.A. Berger, Arch. Environ. Contam. Toxicol. 39, 20-31 (2000).
- 2) Ecological Screening Levels, U.S. EPA, Region 5, 2003.

<http://www.epa.gov/reg5rcra/ca/edql.htm>

C) **Persistent, Bioaccumulative, and Toxic Pollutants**

Persistent, bioaccumulative and toxic (PBT) compounds include but are not limited to the following substances; aldrin/dieldrin, chlordane, 1,1'-(2,2,2trichloroethylidene)bis[4-chlorobenzene] (DDT) and metabolites (DDD+DDE), hexachlorobenzene, hexachlorobutadiene (hexachloro-1,3-butadiene); hexachlorocyclohexanes (BHCs, alpha-BHC, beta-BHC, delta-BHC); lindane (gamma-hexachlorocyclohexane); alkyl-lead, mercury and its compounds, mirex, photomirex, octachlorostyrene, polychlorinated biphenyls (PCBs), 2,3,7,8-tetrachlorodibenzo-p-dioxin (TCDD); dioxin; PCDF (furans), 1,2,3,4- tetrachlorobenzene, 1,2,4,5-tetrachlorobenzene; toxaphene, and other chemicals that are reasonably anticipated to bioaccumulate in animal tissues. Chemicals with Log  $K_{ow}$  values greater or equal to 3.0 which are not metabolized or metabolized slowly by ecological receptors are considered to bioaccumulate in animal tissue. A PBT compound should not be screened from soil or sediment unless the method used to derive the screening value considered exposure to higher trophic level organisms in the development of the screening value. If a PBT is screened out of the assessment, then appropriate documentation should be provided in the Level II Report. If a SMDP is made to remediate the site without completing a Level III ERA, then the remediation goals are to be calculated using the appropriate bioaccumulation (BAF) and bioconcentration factors (BCF) for the detected PBT compounds. See Level III for determining the appropriate BAF and BCF values.

D) **Cumulative Effects**

Screening benchmarks values may be available for chemical classes (*e.g.*, total PAHs). When a class specific screening benchmark value is available, a constituent must meet both the appropriate chemical-specific and class-specific screening benchmark before it can be eliminated from further evaluation. In addition, the potential for adverse effects associated with exposure to multiple contaminants (*i.e.*, all COPECs, as well as COIs not selected as COPECs) should be qualitatively evaluated and discussed in the Level

II report. If evidence supports that the cumulative effects of COIs detected below benchmark values are potentially impacting important ecological receptors then the COIs should be considered as COPECs for future evaluation.

#### E) **Benchmarks Availability**

If screening benchmark values do not exist for any specific COI, then the chemical is to be retained as a COPEC. If additional benchmarks are identified that may be relevant to the ecological assessment, please contact the site coordinator for approval prior to using the values.

#### F) **State and Federally Listed Threatened and Endangered Species**

Toxicologically based benchmark screening values are not to be used for any medium utilized when State or Federally listed Threatened and Endangered (T&E) species are present or potentially present at a site (see Attachment E in the Level I guidance). See section 3.3.10 (c)(i) for additional information on T&E species.

### 3.3.6 **Task 6 COPEC Selection**

COPECs are the remaining chemicals, quantified or identified on-site that exceeded screening benchmark levels, background, chemical specific criteria, did not have screening values available, or were retained for other specific characteristics (e.g., PBT compounds, non-chemical stressors). Site-related non-chemical stressors that may be impacting important ecological receptors are also to be listed as COPECs. Examples of potential non-chemical COPECs may include:

- \$ Elevated total dissolved solids (TDS);
- \$ Elevated or decreased pH concentrations in soils/surface waters;
- \$ Low dissolved oxygen levels in surface waters;
- \$ Cementation of surface water sediments;
- \$ Physical habitat modification; and,
- \$ Elevated temperatures in surface water.

The COPECs should be presented in tabular format, with the table(s) clearly presenting all data from each medium, used to determine whether a COI qualifies as a COPEC. The table(s) should include all stressors (e.g., chemicals and identified nonchemical stressors)

that were not chosen as COPECs. Maximum detected and 95% UCL values (See Attachment I) should also be included in the table(s) when appropriate.

Chemicals and media may be eliminated from further ecological evaluation based on the screening results and compliance with appropriate water quality criteria. If all chemicals are below the screening values for soils and sediments where appropriate and surface waters are in full attainment of all pertinent criteria then the ecological assessment is to be completed by submitting the Level II report (Task 14). If any COPECs were retained or a water body was not in full attainment of the appropriate criteria, then the ecological risk assessment is to continue to complete Tasks 7-13. For sites that had no COPECs based on screening, but surface waters were not in full attainment of the appropriate criteria, see Task 14 for the use of the Level II report for discussions of a water body not being in full attainment of its aquatic life habitat use designation.

### 3.3.7 **Task 7 Conduct Site Survey**

A detailed site survey should be conducted following the screening step (Task 5) and COPEC selection (Task 6). The Level II site survey goes beyond the Level I site visit to gather site-specific qualitative and semi-quantitative data necessary for identifying relevant and complete contaminant-pathway-receptor (exposure pathway) relationships. The completion of the additional site survey and tasks 7-12 is contingent upon COPECs being retained for further evaluation. Tasks 7-12 are also to be completed if a remedial alternative is chosen as part of a SMDP (Task 13). Techniques that may be employed to accomplish the Level II survey may include, but are not limited to, any or all of the following:

- Terrestrial receptor inventory (observation, night-lighting, live and snap traps, nets, Emlen line transects, etc.);
- Geographic information system (GIS) mapping and analysis of survey data; and,
- Habitat/vegetation inventory (observation, line transects, quadrats, habitat evaluation procedures (HEP), etc.).

### 3.3.8 **Task 8 Update Site Description**

A narrative giving a description and analysis of the ecological conditions at, and in the locality of the site is required in the Level II assessment. This narrative should provide greater depth and detail than that allowed for in the Level I checklists and should consider:

- \$ Known and historical types, sources, and extent of contamination;
- \$ Recorded or observed environmental problems, (e.g., observed toxicity; mortality, fish kills, chlorosis in plants, etc.);
- \$ Available results from any previous biological testing, such as data on acute or chronic toxicity or bioaccumulation phenomena;
- \$ Physical and chemical characteristics of abiotic media in the area or climatic, physiographic, and/or geohydrologic features that could create contaminant pathways linking biota with contaminants;
- \$ Location of any T&E species, or their potential habitats, or sensitive environmental areas, on or in the locality of the site;
- \$ Common flora and fauna of the site and surrounding areas, *i.e.*, the most common species likely to be exposed to contaminants;
- \$ Ecological information on biological assemblages or species important to site ecosystems;
- \$ Specific mapping of the site to identify site-specific micro-habitats (areas of use); and,
- \$ Results from any previous ecosystem modeling or GIS-based analyses.

### **3.3.9 Task 9 Revise Conceptual Site Model**

The CSM establishes the complete exposure pathways that will be evaluated in an ecological risk assessment and the relationship of the assessment endpoints to the measurement endpoints. The CSM can be used for a Level III ERA or may be used to help define receptors to be protected if a remedial alternative is chosen for the site.

In a conceptual site model, the possible exposure pathways are depicted in an exposure pathway diagram and must be linked directly to the assessment endpoints. Information on ecologically important receptors, assessment endpoints, COPECs, exposure routes, and potential effects is integrated to create a

preliminary CSM involving both text and graphics and should consist of:

- A) A preliminary set of "risk hypotheses" that describe predicted relationships between COPECs, exposure, and assessment endpoint response; *i.e.*, a statement of how each COPEC might affect important ecological receptors. The risk hypotheses should be written using the traditional null hypothesis format. Examples of risk hypotheses include, the following:
  - \$ The concentration of PCBs in the prey of predatory birds do not exceed levels known to impair reproduction in these birds;
  - \$ The environmental concentration of copper in sediments and surface water is not toxic to aquatic plants or animals;
  - \$ The benthic macroinvertebrate community is not affected by benzene; and,
  - \$ Food chain accumulation and transfer of DDT does not occur to a degree that allows egg shell thinning in piscivorous birds utilizing the site.
- B) A simple box and arrow diagram (Attachment E), showing the relationship between exposure media and ecological receptors and all relevant exposure pathways is to be included as part of the CSM.

### **3.3.10 Task 10 Identify Ecological Receptors**

Site-specific ecologically important receptors are identified using the criteria as follows:

- a) Identify habitat types at and within the locality of the facility.
- b) Identify the plant and animal species most likely to be associated with each habitat type identified in (a) above. Resources to be consulted include results of the initial site visit, the Level II site survey, a review of the available published literature, published government or scientific studies of the area, or information maintained by government agencies, resource conservation groups, or academic institutions.
- c) Identify site-specific receptors for each habitat type. To the extent practicable, these

receptors should be organisms that spend a significant portion of their lives or derive a significant portion of their diets or physiological needs from that habitat type. Species representing all appropriate feeding types (herbivore, carnivore, insectivore, invertivore, etc.) should be listed in the Level II report. Please see Attachment A of the Level III guidance document for information regarding the species to be used in the generic food web models. Please note that the presentation of long lists of species copied from regional or state-wide guidebooks without reference to observations made during the site visit or site survey, or that are not appropriate for the specific habitats found at or in the locality the site are not useful.

- (i) State/Federal Listed-Threatened and Endangered Species Any State or Federal-listed T&E species discovered to use or potentially use the site, for any reason (e.g., nesting, roosting, feeding, etc.) is to be identified in the Level II report. Benchmark screening values are generally not considered protective of T&E species. A Level III ecological risk assessment will be required if any T&E species is identified to use the site or if the site is found to have suitable habitat to support T&E species. The Level III ERA will use each T&E species identified to use the site as an assessment endpoint in an appropriate food web model to identify possible adverse impacts. If a decision is made to move into remedy selection as part of a SMDP before the completion of a IV ERA, then the development of the remediation goals are to be in part calculated based on the pertinent parameters for the appropriate T&E species and any other assessment endpoints associated with the site.
- d) Summarize the results of steps (a-c) above in the form of a table (Attachment C). The Level II Report should also contain text

identifying and describing the T&E species present or potentially present at the site.

### 3.3.11 Task 11 Identify Complete Exposure Pathways

A thorough identification is to be made of relevant and complete exposure pathways that provide exposure of the identified important ecological resources to the COPECs. An exposure route is the means in which a chemical or physical agent comes in contact with a receptor (e.g., ingestion or absorption). Ecological receptors may be exposed to chemical contaminants either through direct (primary) and/or indirect (secondary) exposure routes. Only those pathways that are complete, and are expected to contribute substantially to exposures to ecologically important receptors should be addressed.

- a) For an exposure to a contaminant to occur, a complete exposure pathway must exist, which requires:
- (i) A source and mechanism for contaminant release;
  - (ii) A transport medium;
  - (iii) A point of environmental contact; and,
  - (iv) An exposure route. If any of these four components is absent, a pathway is generally considered incomplete. However, the transport medium may be missing and the pathway still be complete if the contact point is directly at the contaminant release point. A pathway may also be complete if a source and mechanism for contaminant release appear to be absent but (ii), (iii), and (iv) exist, *i.e.*, direct ingestion of a contaminated transport medium.
- b) Identify those pathways that have the greatest potential to bring receptors into contact with toxicologically significant quantities of a given ecological stressor. Some of the possible exposure pathways are listed below:
- (i) Exposure to contaminated soil through incidental ingestion or direct contact;
  - (ii) Exposure to contaminated surface water through ingestion or direct contact;
  - (iii) Exposure to sediments through incidental ingestion or direct contact;
  - (iv) Exposure to ground water through ingestion or direct contact (requires a discharge to surface water by means of seeps, springs, wetlands, etc.); and,
  - (v) Exposure to contaminated tissues through ingestion. Receptors may be exposed to

contaminants that are capable of bioaccumulation and/or bio-magnification or transfer within a food chain.

- c) Select from one or more of the most typical exposure routes summarized (by environmental media) in Attachment D. Identification of typical exposure routes does not rule out the possibility that at certain sites, highly unique exposure routes could bring receptors into contact with significant quantities of contaminants. However, unless demanded by unique site characteristics, it is usually not productive to identify particularly obscure exposure pathways and/or routes as these will ultimately be difficult or impossible to quantify.

### 3.3.12 **Task 12 Identify Candidate Assessment Endpoints**

Assessment endpoints are defined as "explicit expressions of the actual environmental value that is to be protected, operationally defined by an ecological entity and its attributes (U.S. EPA 1998)." Well-crafted assessment endpoints establish a clear logical connection between regulatory goals for a site, endpoint species, and the objectives of the ecological risk assessment. Assessment endpoints should be as specific as possible, rather than broad and all-inclusive, so as to bring focus to the assessment [see EPA guidance (ECO Update, vol. 3, number 1, January 1996, [Ecological Significance, and Selection of Candidate Assessment Endpoints](#), EPA 540/F-95/037)].

- a) The identification of "candidate" assessment endpoints is intended to begin focusing the ecological risk assessment on site-specific ecological features or resources of particular interest to risk managers. This is an opportunity for the risk manager and the risk assessor to begin a dialogue to translate the risk manager's higher-level decision criteria into a statement of assessment objectives.
- b) Assessment endpoints are a required component of an ecological risk assessment. Care must be taken to choose appropriate assessment endpoints. If the results of an ecological risk assessment are to play a meaningful role in the remedial decision process, caution must be exercised when

identifying assessment endpoints (and their associated endpoint species). When identifying assessment endpoints, consider whether there would be a willingness on the part of the risk managers to undertake a potentially costly and/or time-consuming remedial action to alleviate risk if an unacceptable hazard is demonstrated for an endpoint. Such identification works best with input from risk managers, all potential stakeholders, and risk assessors. Two elements are required to define an assessment endpoint: 1) an identification of the specific valued ecological entity; and 2) the characteristic about the entity of concern that is important to protect and potentially at risk.

- c) Assessment endpoints do not represent a desired achievement (*i.e.*, goal). Instead they are ecological values defined by specific entities and their measurable attributes, providing a framework for measuring stress-response relationships. Examples of assessment endpoints include, but are not limited to, the following:

- \$ Survival and growth of soil invertebrates;
- \$ Survival and reproduction success of fish eating birds;
- \$ Shrew populations and reproduction rates; and,
- \$ Wetland benthic community abundance and diversity.

Of the set of ecologically important receptors (identified during Level II and/or Task (11) above), those that have substantial aesthetic, social, or economic value or are important in the biological functions or biodiversity of the system, may be selected for association with assessment endpoints. These ecological receptors linked to specific assessment endpoints are termed "endpoint species". Endpoint species are either themselves the object of protection or serve as surrogates for other ecological receptors requiring protection.

- d) Groups (guilds) of receptors that are examples of candidates for association with assessment endpoints include, but are not limited to: benthic or epibenthic aquatic invertebrates; small mammalian predators whose diets consists of soil invertebrates;



small mammalian herbivores; ground-feeding avian predators; piscivorous avian predators whose diet is made up of fish; omnivorous waterfowl whose diet includes aquatic macrophytes and invertebrates.

- e) Any candidate endpoints identified at this point may be further refined in terms of receptors and potential effects during Task 1 of a Level III assessment. Also at that time, assessment endpoints will be linked to related measures of exposure and effects.
- f) All State and/or Federally-listed T&E species located at or in the locality of the site must be included as assessment endpoints and endpoint species.

- (v) Does the locality of the facility contain sufficient suitable habitat to support a local population of endpoint species?
- b) If (i) is "No" and (ii) is "Yes", then the site is highly unlikely to present ecological risks and a recommendation for no further ecological investigations should be made.
- c) If (i), (iii), (iv), and (v) are "Yes", then the site could present ecological risks and a recommendation to move to SMDP should be made.
- d) If (i) is "Yes" and (ii) is "No", then the site could present ecological risks and a recommendation to move to SMDP should be made.

### 3.3.13 **Task 13 SMDP: (Ecological Risk Probable?)**

For a site to present a potential for hazard, it must exhibit the following three conditions: (a) contain COPECs in media at detectable and biologically significant concentrations, (b) provide exposure pathways linking COPECs to ecological receptors, and (c) have endpoint species that either utilize the site, are not observed to utilize the site but habitat is such that the endpoints species should be present, are present nearby, or can potentially come into contact with site-related COPECs. Thus, the Level II deliverable should identify if COPECs, endpoint species, and complete exposure pathways exist at or in the locality of the site.

- a) Specific conditions are as follows:
  - (i) Are COPECs in any medium present at the site?
  - (ii) Are surface waters meeting all applicable criteria?
  - (iii) Are ecological receptors present or potentially present at the site, or could be exposed to site related COPECs?
  - (iv) Based on site-specific information gathered during the site visit and/or site survey, knowledge of COPEC characteristics, receptor behavior, and professional judgment, do there appear to be plausible links between ecological stressors and T&E or non-T&E endpoint species?

### **(Remedial Decision Possible?)**

Are risk managers willing to make a response action decision with existing information and current levels of uncertainty? A decision for remedial action is possible anytime after step B of the flowchart. Key questions: Would cleanup be less costly than further investigation? Are data adequate to approve a removal action or to select or approve a remedy? If "Yes", then further ecological investigation is deferred in favor of a response action. If "No", then the assessment process proceeds to Level III for further evaluation of the ecological risks posed by site related COPECs. A SMDP is offered at two different times throughout the Level II ERA. The Level II flow chart identifies the SMDPs and their appropriate times for use during the Level II ERA process.

### 3.3.14 **Task 14 Submit Level II Report**

The Level II report is to summarize the results of all tasks that were completed during the Level II ERA in a concise and logical manner. The report will also summarize the investigations that have occurred and any relevant site information regarding the ecological habitat and health of the site. The Level II report is a deliverable which identifies COPECs, site-specific receptors, relevant and complete exposure pathways, and other pertinent information for conducting a Level II ERA if a SMDP was

chosen to continue the ecological assessment in a Level II ERA. If a decision was made to move into remedy selection, then the Level II report is to discuss the results of each task completed. For sites completing an RI/FS the report should also list the appropriate values (e.g., background, screening or other values) to be used in the FS. The report may also discuss upstream sources of contamination in surface waters and anthropogenic compounds detected in all media during the site investigation process. Sites containing surface water that were not full attainment of their appropriate aquatic life habitat use designation(s) may also use the report to summarize information regarding non-chemical impacts and reasons other than contamination that may be responsible for the water body not being in full attainment. See Attachment F for an outline of the Level II report and expected contents.

### Attachment A Level II Flowchart and Legend (Tasks 2-6)

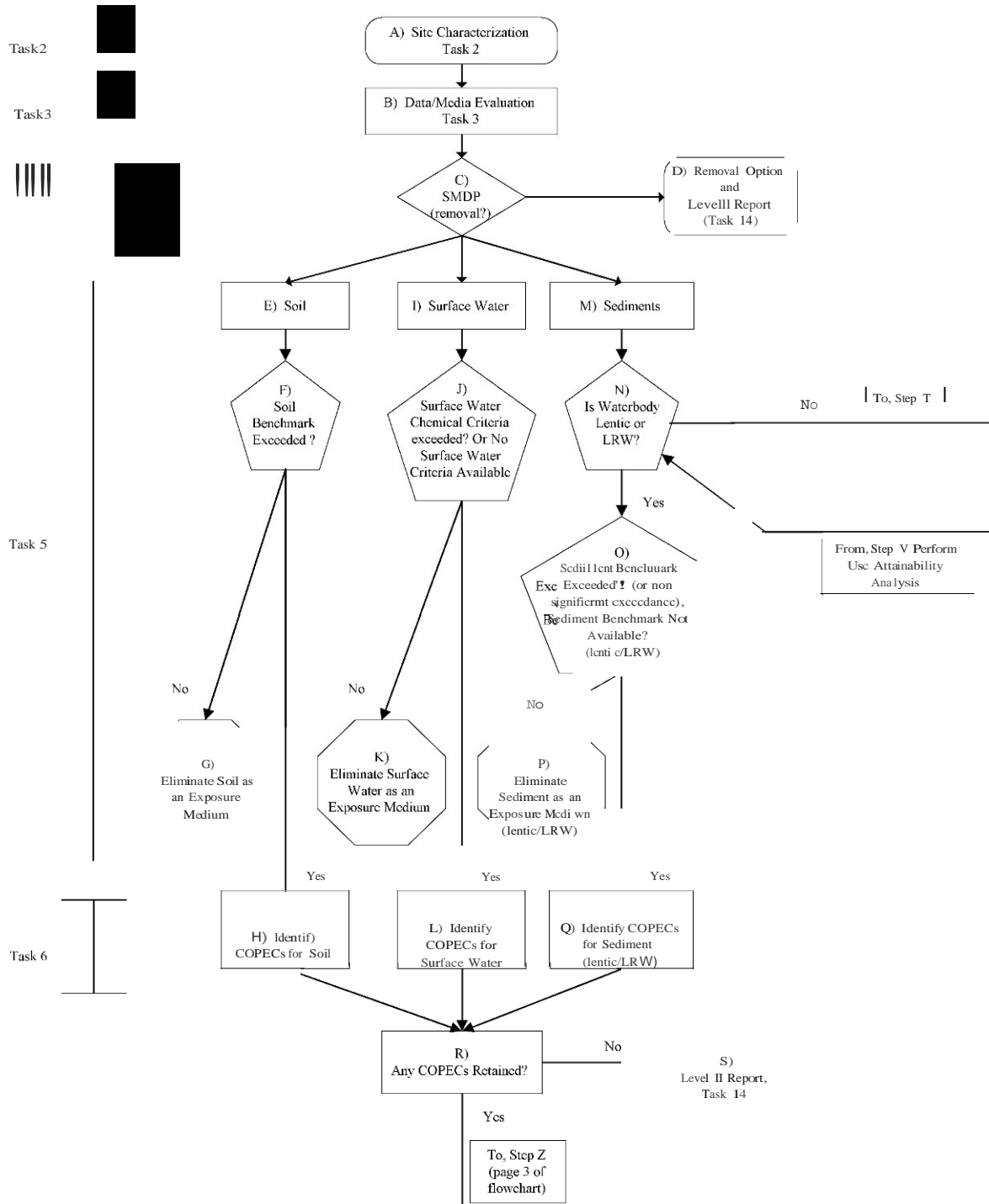

**Level II Flowchart (continued)  
(Tasks 5-6 continued)**

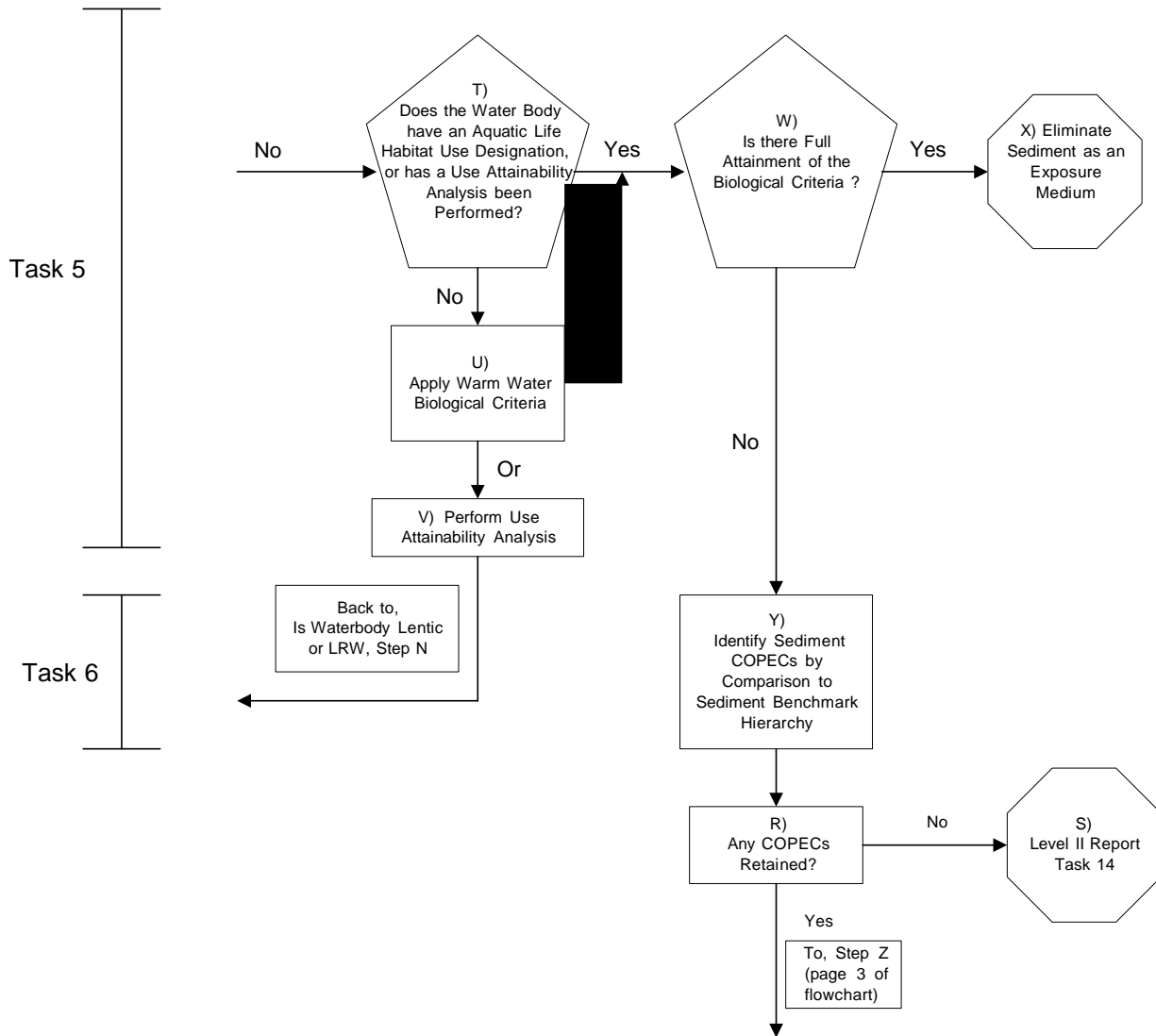

**Level II Flowchart (continued)  
(Tasks 7 continued)**

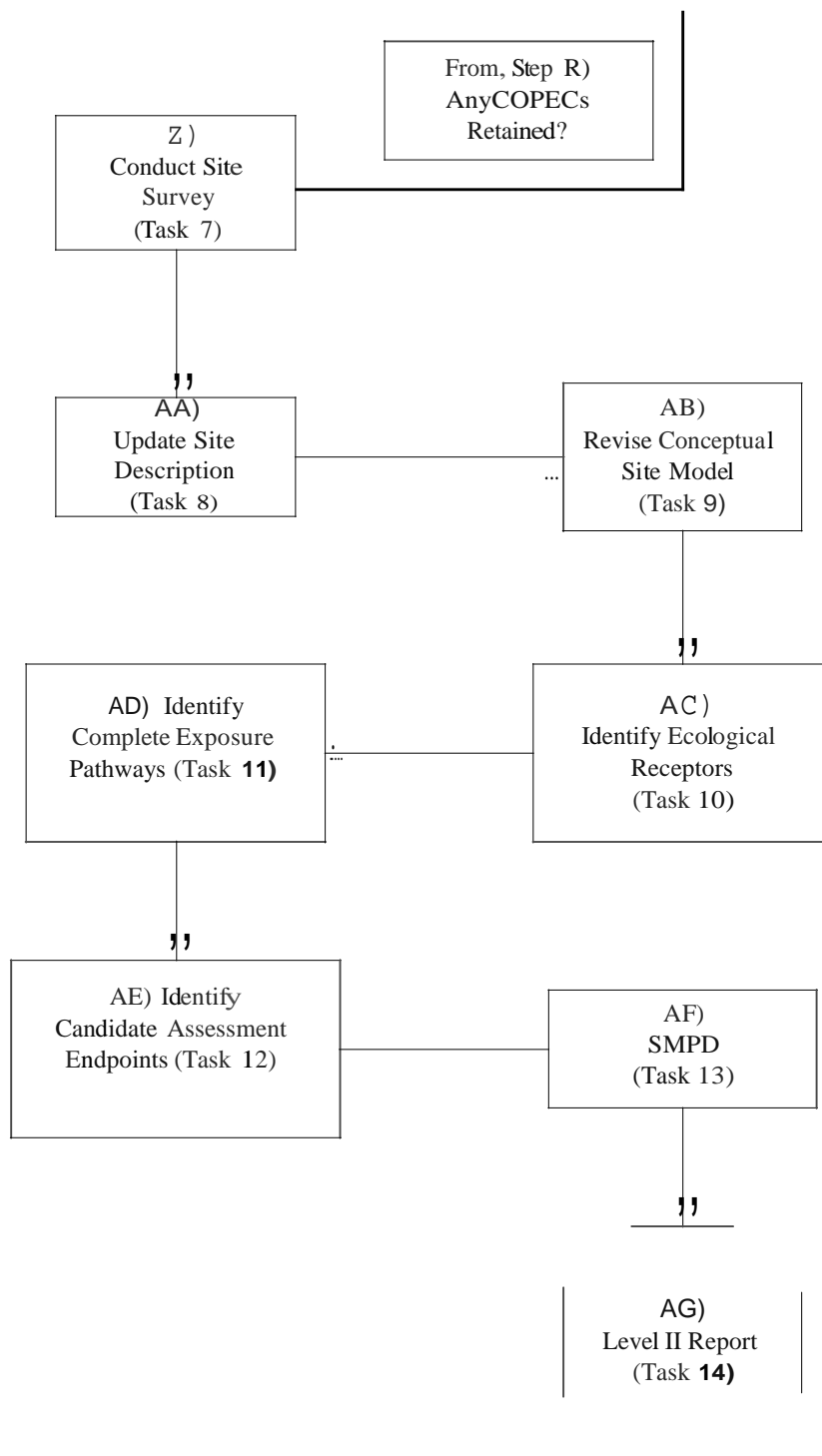

### Flowchart Legend

#### A) Site Characterization (Task 2)

Site characterization is completed after a Level I ERA has been finished, and prior to beginning a Level II ERA. Site characterization consists of all necessary media sampling and investigations including biological criteria if necessary, that will adequately define the nature and extent of contamination, the attainment status of impacted surface water bodies, and if desired, the representative background conditions at or near the site.

#### B) Data/Media Evaluation (Task 3)

Data/Media evaluation is comprised of two processes: (I) Data Evaluation to determine if any chemicals can be eliminated from the risk assessment by a frequency of detection screen and (II) Media Evaluation, to determine if site-related chemicals have impacted media associated with the site.

- I) *Data Evaluation*: Any chemical in any medium may be eliminated if it is detected at a frequency of less than 5 percent. Common laboratory contaminants may also be eliminated if appropriate.
- II) *Media evaluation*: This evaluation is to determine whether or not site-related chemicals have impacted media associated with the site.
  - 1) Comparison to background concentrations
  - 2) Ohio Specific Sediment Reference Values
  - 3) Persistent, Bioaccumulative, and Toxic (PBT) Compounds  
PBT compounds detected in surface water, sediment, or soil are to be listed as COPECs. PBT compounds are defined and discussed in 3.3.5 (C) of the Level II ERA guidance.

#### C) SMDP (removal) (Task 4)

SMDP (removal) is offered following the completion of the data/media evaluation step (Task 3). The only options available at this SMDP are either a removal of contaminated media or the exit of the Level II ERA process at this point as a result of soil, sediment, and surface waters being demonstrated to be consistent with background conditions of the site.

#### D) Removal Option (Task 4) and/or Level II Report (Task 14)

A complete removal is the only remedy offered with the removal SMDP. For sites exiting the Level II ERA process because soil, sediment and surface waters were demonstrated to be consistent with background conditions, see step S of the flow chart and Task 14 for details on the Level II report.

#### E) Soil (Task 5)

Soil refers to terrestrial habitats at the site and can include any non-hydric soil. Hydric soils are considered under surface water and sediments where appropriate.

#### F) Soil Benchmark Exceeded? (Task 5)

This step refers to the comparison of chemicals detected in on-site soils to values cited in the soil screening benchmark hierarchy given in 3.3.5 (A). If the maximum soil concentrations are below or equal to the benchmark values, then they may be eliminated from the ecological risk assessment.

#### G) Eliminate Soil as an Exposure Medium (Task 5)

Soil may be eliminated as an exposure medium only if all detected chemicals carried through the flow chart process are below or equal to the soil benchmark values, or only minor exceedances are

observed. If soil is to be eliminated as an exposure medium, then the results and rationale are to be given in the Level II report.

**H) Identify COPECs for Soil (Task 6)**

The COPECs identified for soil will be those chemicals detected in soil and not eliminated during steps B (Task 3) and F of the flowchart. Soil COPECs are to be listed in the Level II report.

**I) Surface Water (Task 5)**

Surface Water refers to any surface water bodies on-site or those that may be influenced by site contamination.

**J) Surface Water Chemical Criteria Exceeded? or, No Surface Water Criteria Available (Task 5)**

Surface water concentrations of all water bodies are to be compared to the Ohio EPA Chemical Specific Water Quality Criteria found in OAC 3745. If all surface water chemicals detected in surface waters on-site are below their appropriate chemical criteria and chemical criteria exist for all detected compounds, then surface water can be eliminated as an exposure medium. If surface water chemicals exceed their chemical criteria, no chemical criteria are available, or PBT compounds (3.3.5 (C)) are present in surface water, then they are to be retained as surface water COPECs.

**K) Eliminate Surface Water as an exposure Medium (Task 5)**

The elimination of surface water as an exposure medium is completed only if all detected chemicals are below their appropriate surface water criteria. The results and rationale are to be given in the Level II report to satisfy the exclusion of compounds and/or media from further ecological risk evaluation.

**L) Identify COPECs for Surface Water (Task 6)**

The remaining chemicals, if any, from the comparison of compounds detected in surface waters to the Ohio Surface Water Criteria, described in step J are listed in the Level II report as COPECs for surface waters. See 3.3.5 (C) regarding the inclusion of PBT compounds.

**M) Sediment (Task 5)**

Sediment underlying surface waters is to be evaluated under the sediment pathway, starting at step M of the flow chart. Materials underlying wetlands (sediments) are to be evaluated as sediments or soils, depending on the type of wetlands. See 3.3.5 (B)(ii)(c) of the Level II ERA guidance document for a discussion about wetland soils/sediments.

**N) Is Water body Lentic or LRW? (Task 5)**

This question asks if the water body(ies) on-site is lentic (non flowing systems such as lakes, ponds, wetlands, etc.), or if the flowing surface water body(ies) on site has been designated as Limited Resource Waters (LRW) by the State of Ohio. If the impacted surface water is lotic and has not been designated LRW, then continue to step T. Sediments associated with lentic or LRW designated water bodies, or wetlands where appropriate, are to continue to step O of the flow chart.

**O) Sediment Benchmark Exceeded? (Or non significant exceedances), No Sediment Benchmark Available? (lentic/LRW) (Task 5)**

Sediment concentrations are to be compared to the appropriate benchmark values given in the sediment screening hierarchy listed in 3.3.5 (B)(ii)(d). If the sediment concentrations exceed the sediment benchmark values, or if no sediment benchmarks are available, or PBT compounds are present in sediments and the benchmark values have not considered higher trophic level exposures in the derivation of the value (see 3.3.5 (C)) then, the chemicals are to be retained as sediment COPECs ((Task 6) step Q of the flowchart)).

**P) Eliminate Sediment as an Exposure Medium (lentic/LRW) (Task 5)**

The elimination of sediments as an exposure medium is completed only if all detected chemicals are below their appropriate benchmark values or only minor exceedances are observed. See 3.3.5 (C) regarding PBT compounds. All results and rationale are to be given in the Level II report for the exclusion of compounds and/or media from further ecological risk evaluation.

**Q) Identify COPECs for Sediment (lentic/LRW) (Task 6)**

The COPECs identified for lentic or LRW associated sediments will be the chemicals remaining after the comparison to the appropriate benchmark values (step O). The sediment COPECs are to be listed in the Level II report.

**R) Any COPECs Retained?**

Step R questions if there are any chemicals that exceed the appropriate screening values. If all chemicals are below the appropriate values and surface waters are in full attainment of all pertinent criteria, then the ecological assessment is to be completed by submitting the Level II report (Task 14). If any COPECs are retained or a water body was not in full attainment of the appropriate criteria, the ecological risk assessment is to continue to complete Tasks 7-13. For sites that have no COPECs but surface waters are not in full attainment of the appropriate criteria, see Task 14 for the use of the Level II report for discussions of a water body not being in full attainment of its aquatic life habitat use designation.

**S) Level II Report (Task 14)**

The Level II report is the terminus of the Level II flowchart and the Level II ecological risk assessment. A report will summarize all of the results of the Level II investigation that will explain which media have been retained as exposure media and if and why media were eliminated from further evaluation. If a removal or other remedial action is pursued under an RI/FS, then the pertinent information regarding the remediation goals are also to be included in the Level II report. The report will list the COPECs for each medium and the appropriate details required in the Level II report. If media and chemicals remain after the screening processes, then additional details may also be required in the Level II report. See Task 14 and Attachment F of the Level II ERA guidance document for the specific requirements.

**T) Does the Water Body have an Aquatic Life Use Habitat Designation or has a Use Attainability Analysis been Performed? (Task 5)**

This step is to determine whether or not the flowing surface water body has been designated by Ohio EPA or if a use attainability analysis has been performed by Ohio EPA or other qualified investigator. Aquatic life habitat use designations are listed in OAC 3745-1-07 through 3745-1-30. The website for the Ohio EPA Division of Surface Water should be reviewed to determine if any changes to the aquatic life use habitat designations or surface water rules have been up-dated (<http://www.epa.state.oh.us/dsw/>). If the flowing water body has not been designated, or is too distant from a designated stream or section of stream, then the water body will either need to be designated or criteria for warm water habitat may be applied to the water body.

**U) Apply Warm Water Criteria (Task 5)**

If a lotic surface water body on site has not been designated or is too distant from a designated section of a lotic water body, then the warm water aquatic life habitat use designation criteria apply, or a use attainability analysis is to be performed and the water body designated using the results from the analysis. Please refer to section 3.3.5 (B)(ii)(b) for a discussion regarding the water body designation process.

**V) Perform Use Attainability Analysis (Task 5)**

A use attainability analysis may be performed to determine the appropriate aquatic life habitat use designation for the lotic water body. This may be beneficial and/or cost effective when a lotic water



body without an official use designation is believed to be a “limited resource water body” or have a designation other than warm water habitat. The Ohio EPA site coordinator should be contacted prior to planning a use attainability analysis for an RI/FS project. Similarly, the VAP should be contacted for VAP projects. Following the use attainability analysis and confirmation of the results with the Ohio EPA Division of Surface Water, the ecological evaluation is to continue again at step N of the Level II flowchart.

**W) Is there Full Attainment of the Biological Criteria? (Task 5)**

Full attainment of the appropriate aquatic life habitat use designation is required for designated lotic water bodies other than limited resource waters, or lotic water bodies that are using the warm water habitat designation criteria, once sediment contamination has been identified (Task 3, step B in the flowchart). If the water body is not in full attainment of the appropriate aquatic life habitat use designation, then sediment associated COPECs are identified in step Y of the Level II flowchart. The results of the biological/habitat evaluations are to be included in the Level II report regardless of the attainment status of the water bodies.

**X) Eliminate Sediment as an Exposure Medium (Task 5)**

The elimination of sediments as an exposure medium for a designated lotic water body other than LRW, or a lotic water body that is using the warm water habitat designation criteria, is completed only if the water body is in full attainment of its aquatic life habitat use designation and PBT compounds are not present in sediments.

**Note: Steps Y-AD (Tasks 7-12) are only to be completed if COPECs are retained for further evaluation.**

**Y) Identify Sediment COPECs by Comparison to Sediment Benchmark Hierarchy (Task 5)**

Sediment COPECs are to be determined if the lotic water body does not fully attain its aquatic life use designation. The sediment chemical concentrations are to be compared to the appropriate sediment benchmark values from the sediment benchmark hierarchy given in section 3.3.5 (B)(ii)(d). Any chemical that exceeds its appropriate benchmark value or does not have an available benchmark is to be retained as a sediment COPEC and listed in the Level II report. Please see section 3.3.5 (C) for information regarding the elimination of PBT compounds in sediment.

**Z) Conduct Site Survey (Task 7)**

The Level II site survey is intended to identify habitats and organisms that are potentially exposed to site-related contaminants.

**AA) Update Site Description (Task 8)**

The site description given in the Level II report is to include all relevant information gathered during the Level II and previous ERAs regarding habitats and ecological receptors at or in the locality of the site.

**AB) Revise Conceptual Site Model (Task 9)**

A conceptual site model is to be developed for the site and given in the Level II report. The CSM is to consist of both a written description and a graphical representation of the completed contaminant migration/exposure pathways, receptors, and other relevant information that describes the flow of contaminants through the various habitats/receptors associated with the site.

**AC) Identify Ecological Receptors (Task 10)**

Site-specific ecological receptors identified on-site or receptors that have the potential to use the site are to be listed in the Level II report.

**AD) Identify Complete Exposure Pathways (Task 11)**

A list of relevant and complete exposure pathways are to be given in the Level II report.

**AE) Identify Candidate Assessment Endpoints (Task 12)**

Specific assessment endpoints are to be listed in the Level II report given the complete exposure pathways and receptors identified in Task 9.

**AF) SMDP (Task 13)**

The SMDP will be a decision that is documented in the Level II report. The following three decisions are possible for the SMDP:

- a) no further ecological investigations are required;
- b) continued ecological investigations will be pursued in a Level III or greater ERA; or,
- c) move into remedy selection using criteria from the Level II ERA process.

**AG) Level II Report (Task 14)**

The Level II report is to summarize the results of all tasks that were completed during the Level II ERA in a concise and logical manner and discuss any relevant site information regarding the ecological habitat(s) and health of the site.



**Attachment C**  
**Summary of Ecological Receptors (by habitat)**

Habitat Type (1)	Habitat Type (2)	Expected Species	Observed Species	Time Observed (am/pm)	Relative Occurrence	T&E Species

- 1) Habitat type may include: wooded, old field, oak/willow riparian, etc.
- 2) Percentage of habitat type (habitat type in acres/ total acres).

\*\*\* Note: This checklist provides a suggested format. The format may be altered to fit the needs of the facility; however, all requested information should be presented.

**Attachment D**  
**Exposure Media for Ecological Receptors**

Environmental Media	Comments
Surface Water	<p>Aquatic receptors may be exposed through osmotic exchange or respiration of surface waters.</p> <p>Contaminants may also be taken-up by terrestrial plants whose roots are in contact with surface waters.</p> <p>Terrestrial receptors may ingest water-borne contaminants if contaminated surface waters are used as a drinking water source.</p>
Ground Water	<p>Contaminants may be taken-up by terrestrial plants whose roots are in contact with ground water present within the root zone (~1 m depth).</p> <p>Receptors generally will not contact ground water unless it is discharged to the surface, at which time it should be evaluated as surface water.</p>
Sediment	<p>Aquatic receptors may be directly exposed to sediments or may be exposed through osmotic exchange, respiration or ventilation of sediment pore waters.</p> <p>Exposure of emergent aquatic plants rooted in contaminated sediment.</p> <p>If sediments are present in an area that is only periodically inundated with water, terrestrial species may have direct access to sediments for the purposes of incidental ingestion. In this instance, sediment exposure would be evaluated as soil exposure.</p>
Soil	<p>Contaminants in bulk soil may partition into soil solution, making them available to roots.</p> <p>Incidental ingestion of contaminated soil could occur while animals search for food, reside in the soil, and feed on plant matter covered with contaminated soil or during grooming.</p>
Tissue	<p>Higher trophic level terrestrial and aquatic consumers and predators, not necessarily in direct contact with any contaminated media, may be exposed through consumption of contaminated food sources.</p>

### Attachment E CSM Diagram (example)

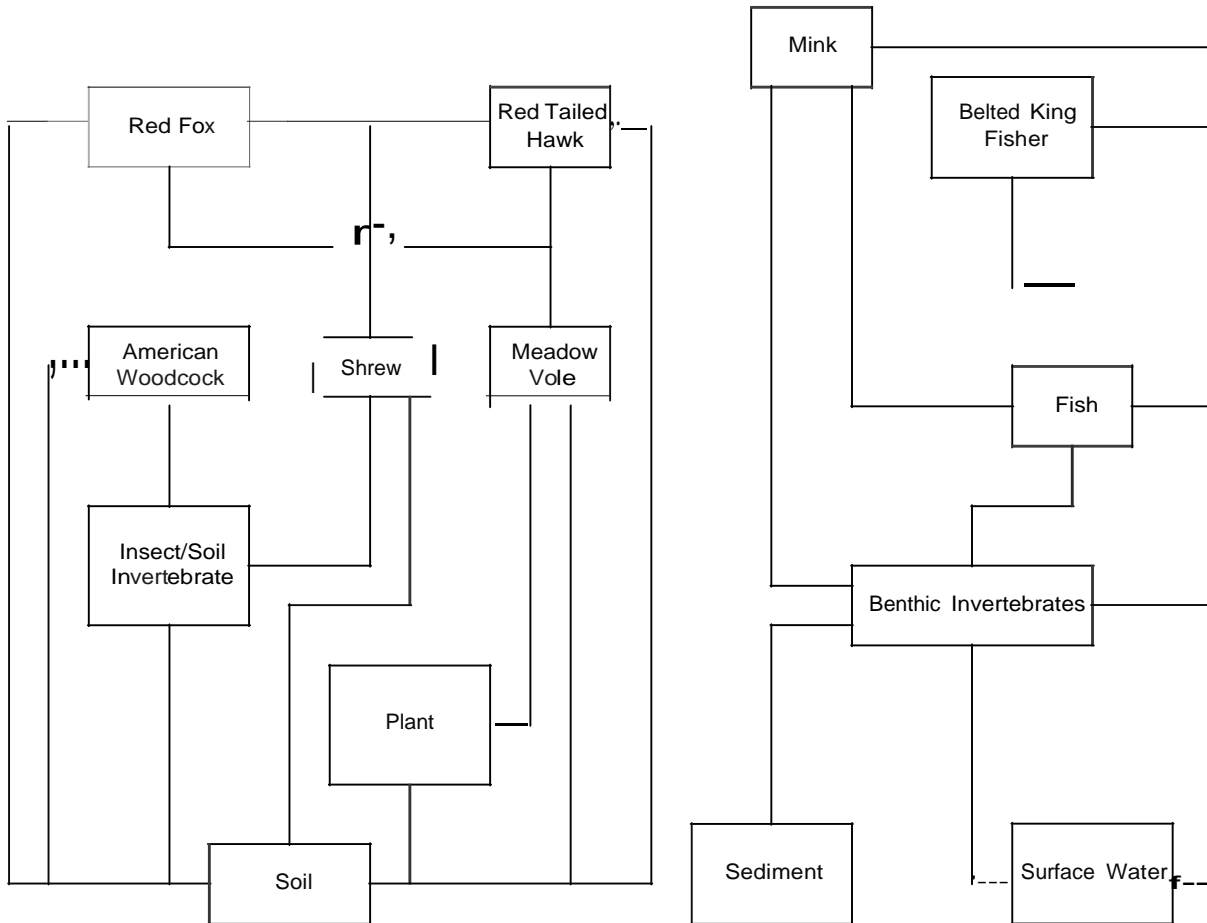

## **Attachment F Level II Report - Outline**

### **(1) INTRODUCTION**

- (a) Site History
- (b) Regulatory Status
- (c) Level I Report

### **(2) SITE SURVEY**

- (a) Objectives and Scope
- (b) Methodology
- (c) Results

### **(3) RESULTS**

- (a) Site Description
- (b) Site-specific Ecological Receptors\*
  
- (c) T&E Species
- (d) Candidate Assessment Endpoints\*
- (e) Contaminants of Potential Ecological Concern (COPECs)\*
- (f) Relevant and Complete Exposure Pathways\*
- (g) Preliminary Conceptual Site Model\*

### **(4) RECOMMENDATIONS**

### **(5) ATTACHMENTS**

- (a) Regional map showing location of site
- (b) Local map showing site in relation to adjacent property
- (c) Site map
- (d) Map of ecological habitats as overlay to site map
- (e) Map of known or suspected extent of COPECs as overlay to site map

\* Only applicable if the site progresses beyond Task 5

Note: Sites under enforcement may be required to submit a Risk Assessment Assumptions Document (RAAD) prior to completing a Level II or Level III. This information should be provided in the Generic or site-specific Statement of Work (SOW) that is attached to the orders.

**Attachment G  
Point of Exposure**

Medium	Depth	Rationale
Soil	0-1.2 m*	Based on burrowing animals
Sediment	0-15 cm*	Based on the depth of macroinvertebrate activities in sediment
Surface Water	All waters	
Tissue	Whole body concentrations	Based on the fact that most of the prey is consumed by the predator

\* Site specific conditions need to be addressed including the nature and extent of contamination and the actual point of exposure needs to reflect the appropriate soil depth (e.g., considering burrowing animals, site-specific receptors) or sediment depth (e.g., as the result of scouring, depositional areas).



## Attachment H OHIO SPECIFIC SEDIMENT REFERENCE VALUES

### INTRODUCTION

The decision to remediate potential contamination of an environmental medium (e.g., air, soil, ground or surface water, sediments) on the basis of potential impacts to ecological receptors is based in part, upon the concentration of the chemical(s) in the medium. In the case of evaluating impacts to sediments, one option is to demonstrate that the chemical concentrations may be acceptable using toxicological benchmark screening values. However, these are often not directly associated with ecological integrity.

The utility of these benchmarks is somewhat limited for several reasons. Generally, these benchmarks are developed based on potential adverse effects to a variety of organisms using bioassays, receptor intake modeling (exposure models using toxicity threshold criteria and hazard quotient methodologies), or, more rarely, measured responses in actual contaminated environments. If the benchmark values are based on bioassays, then often pollutant tolerant species were used due to their ability to survive and reproduce in captivity or laboratory environments. It is also likely that the organisms used in the development of the conservative benchmark values may not be associated with the site. In addition, many of these benchmark values are applied regardless of the specific media characteristics or regional differences associated with the development of the benchmark values.

A second option is to compare chemical concentrations in potentially impacted sediments to background levels derived from non- or minimally impacted locations. In the context of this communication, background is defined as the concentration of naturally occurring chemicals that are unaffected by any current or past activities involving the management, handling, treatment, storage, or disposal of chemicals. The use of background concentrations of chemicals in identifying potential contamination has been a common practice and, although most regulatory agencies allow the screening of potentially contaminated media based on background conditions, the development of site-specific background concentrations is limited due to the number of samples and associated costs often required to permit a statistically relevant estimation of background.

As a potential resource and cost effective alternative to the latter approach, Ohio-specific Sediment Reference Values (SRVs) were developed to identify representative background sediment concentrations for lotic (flowing) water bodies. The SRVs will more conclusively identify whether a site has been contaminated, as reliable background values can be used to identify if sediments have concentrations of chemicals above a level considered to be representative of the area. The ability to develop background sediment concentrations including regional differences in Ohio were based on the sediment sampling conducted at biological reference sites. These reference sites were the same sites used in the development of biological criteria in Ohio.

#### *Biological Criteria and Reference Areas*

Biological criteria are narrative and measurable attributes of aquatic communities. These attributes include macroinvertebrate and fish community structure and function combined with habitat evaluations (Yoder and Rankin, 1996). In Ohio, numerical biological criteria were developed using a regional reference site approach (Ohio EPA 1987a,b; Ohio EPA 1989; Yoder 1989; Yoder and Rankin 1995). The development of the SRVs also used the same regional approach as the data used in the development of the biological criteria, with sediment and biological sites often co-occurring (Figure 1).

Sediment samples were taken from reference areas, also called least impacted site, throughout the state that have been used historically to develop the biological criteria as part of the State of Ohio's water quality standards. These reference areas were selected as being representative of least impacted conditions in the watersheds for which they serve as models. In Ohio, parts of five ecoregions occur (Figure 1). An ecoregion is a relatively homogenous area where boundaries of several key geographic variables more or less coincide (Hughes et al. 1986). In using the ecoregion/reference site approach the reference sites serve as benchmarks for measuring the condition of other sites within the same ecoregion (Ohio EPA 1987b).

## Materials and Methods

### *Sample collection*

Sediment data was collected from lotic Ohio surface water bodies in all five ecoregions from approximately 1984 through 2001. Sediments were sampled in accordance with Ohio EPA sediment sampling guidelines (Ohio EPA 2001) which specify that samples be taken, when possible, in sediment deposition zones. A majority of these samples were taken as part of the Ohio EPA surface water program to assess water resource conditions in rivers and streams of Ohio. In addition, sediment samples collected as part of Division of Emergency and Remedial Response's site assessments (co-occurring at biological reference sites) and the Lake Erie watershed biological reference site sediment characterization project (Ohio EPA 1999a) were included. A total of 512 bulk sediment chemistry results were used in this analysis.

### *Laboratory analysis*

Chemical analysis of the sediments was performed using methodologies summarized in Table 1. Specific analysis to determine metal speciation were not conducted.

Table 1: Summary of analytical methodologies<sup>1</sup>

Analytical technique	USEPA Methodology
Graphite furnace atomic absorption spectrometry (GFAA)	USEPA 7041, 7060A, 7131A, 7421, 7740, 7760A, 7841,
Cold vapor atomic absorption spectrophotometry - (CVAA)	USEPA 7471A, 245.5
Inductively coupled plasma-atomic emission spectrometry (ICP-AES)	USEPA 6110B
Stabilized temperature GFAA	USEPA 200.15

<sup>1</sup> All methods listed are SW-846 (excluding USEPA 245.5 and 200.15)

Sediment chemical concentrations were reported on a bulk dry-weight basis. Dry-weight data were used as previous studies regarding predictive toxicity -based values indicate that they predict effects as well or better than values that are based on carbon-normalized data. (Barrick et al. 1988; Long et al. 1995; Ingersoll et al. 1996; U.S. EPA 1996a; MacDonald 1997).

Data consisted of single discrete chemical samples and samples taken for quality assurance and quality control (QA/QC) purposes. Data from individual samples were used as is. Data derived from field split samples were averaged between the splits. This was based on the fact that split samples were duplicate

aliquots taken from the same mixed sample. Field split samples were collected to verify field compositing techniques and sediment homogeneity within a single collected sample (Ohio EPA 2001). In contrast, station replicate samples were completely separate QA/QC samples. However, these station replicates were taken in the same general vicinity as the sample of interest. Replicate samples can be collected to determine the variability of the concentrations of chemicals in the sediment at a specific site and/or as an assessment of a field sampling technique. Based on the above, replicate data points were considered as discrete values in the development of the SRVs.

#### *Treatment of Detection Limits*

In evaluating any environmental dataset the presence of numerous detection limits can complicate its statistical analysis, due to the clustering of single values often at or near the lower extreme of the data range. Because these data represent actual, albeit somewhat uncertain quantitative data, but also include, in general, the lowest sample concentrations, their inclusion in a complete analysis is critical. The usual approach to dealing with detection limits is to use either the detection limit itself, or some constant fraction (e.g. 0.5 or 0.1) of the detection limit. Because this approach does not relieve the issue of data clustering, an alternative approach to evaluating detection limits was employed.

Given that a detection limit represents the theoretical maximum concentration that could be measured in a specific sample, the true sample concentration is a value somewhere between 0 and the detection limit. The probability that the actual value approximates any specific value within that range is equal for all values in the range. That is, if a random number between 0 and the detection limit were chosen, the likelihood that it would be a better or worse representation of the actual value than 0, the detection limit itself, or any fraction of the detection limit is the same. The advantage in choosing a random number however, is that while it has the same level of uncertainty as choosing a value such as 0.5 times the detection limit to represent the true concentration, the likelihood of drawing the same number for each occurrence of a detection limit is quite small. Thus, distributional issues due to clustering at a single value, as well as inappropriate statistical bias to a particular value as a better representation of the true value, is eliminated. The importance of using this approach increases as the percentage of concentrations reported as detection limits increases.

A second issue regarding detection limits is related to samples in which high detection limits are reported. In these cases, it was assumed that sample conditions were such that an accurate measurement of a specific constituent could not be made. Therefore, as an initial screen, all detection limits were evaluated in the context of maximum measured concentrations for each constituent. In instances where the detection limit exceeded the maximum measured concentration for a specific analyte, the sample was excluded for that particular analyte. Detection limits passing this criterion were included in the evaluation as a random number between 0 and the detection limit.

#### *Statistical Analysis*

Once all detection limits had been adjusted as noted above, the data were first evaluated for underlying distributions (normal or lognormal) using probability plots of original and transformed data. Results of this analysis indicated that in most cases, the data were neither normally nor lognormally distributed. This was confirmed using a Komolgorov/Smirnov nonparametric test for normality.

Based upon this finding, individual constituents grouped by ecoregion were evaluated in order to determine whether significant differences existed between concentrations observed in each ecoregion. Because the data were not normally distributed a nonparametric Kruskal-Wallis test was used in lieu of a standard one-way analysis of variance. Based upon this evaluation, most constituents exhibited significant differences ( $p < 0.05$ ) among concentrations observed at one or more ecoregions. In those cases where no significant differences were observed, a single statewide reference value was derived. In instances where a significant difference was observed, individual reference values were calculated for each ecoregion.

In some instances, insufficient data ( $n < 12$ ) precluded derivation of either an ecoregion-specific reference value, or determination of whether or not a statewide value would accurately reflect concentrations for a specific ecoregion. In those instances, no value is provided and it is recommended that site-specific background concentrations for these specific constituents be developed on a case-by-case basis.

#### *Derivation of SRVs*

Once it was determined that a statewide or ecoregion value should be developed, the data were pooled for each constituent as appropriate and a representative value was derived. The derivation and use of an upper-bound confidence limit of a defined sample quantile (e.g. 90<sup>th</sup> percentile) as an appropriate representation of the background population was precluded because the data could not, in general, be fit to an underlying distribution. As an alternative approach, the value was derived as a cutoff value, above which a value would be considered an outlier (Ohio EPA1999b). Using this technique, the reference value was defined as the interquartile range (distance between the 25<sup>th</sup> and 75<sup>th</sup> percentile) multiplied by 1.5 and added to the upper quartile (75<sup>th</sup> percentile) value. This value is consistent with the upper inner fence on a standard box plot.

#### **Results**

The SRVs given in Table 2 may be used in conjunction with, or in lieu of, generating site-specific background concentrations to determine whether sediments have been potentially impacted by site-related activities. As mentioned above, it should be noted that the SRVs **are not** Ohio EPA standards or criteria. The values are to be used as a screening tool for sites that have identified potential sediment contamination in lotic waterbodies. Where indicated, ecoregion specific values are provided and are appropriate for sites within that ecoregion (see Figure 1 for ecoregion boundaries and abbreviations).

The maximum sediment concentration value for each constituent detected in lotic sediments is to be compared to the appropriate SRV. If the maximum detected value is less than the SRV, then the constituent may be eliminated from further consideration in the aquatic ecological risk assessment. If all site-related constituents are below the appropriate SRVs, then it is considered that the site did not impact the sediments in question. Other qualitative evaluations (e.g., site sediments approximate background conditions, lentic sediment evaluations) may also be made using the SRVs, however, these evaluations should be discussed and approved prior to the submission of any risk assessment reports. Constituents without SRVs are to be retained for further evaluation or compared to site-specific background values identified from upstream sediment concentrations.

Table 2: Sediment Reference Values (mg/kg)

	ECBP	EOLP	HELP	IP	WAP	Statewide
aluminum	3.9E+04	2.9E+04	4.2E+04	2.8E+04	5.3E+04	
antimony	9.2E-01	1.3E+00	8.4E-01	NA <sup>1</sup>	NA	
arsenic	1.8E+01	2.5E+01	1.1E+01	1.1E+01	1.9E+01	
barium	2.4E+02	1.9E+02	2.1E+02	1.7E+02	3.6E+02	
beryllium				NA	NA	8.0E-01
cadmium	9.0E-01	7.9E-01	9.6E-01	3.0E-01	8.0E-01	
calcium	1.2E+05	2.1E+04	1.1E+05	9.4E+04	2.7E+04	
chromium	4.0E+01	2.9E+01	5.1E+01	3.0E+01	5.3E+01	
cobalt				NA	NA	1.2E+01
copper	3.4E+01	3.2E+01	4.2E+01	2.5E+01	3.3E+01	
iron	3.3E+04	4.1E+04	4.4E+04	3.1E+04	5.1E+04	
lead						4.7E+01
magnesium	3.5E+04	7.1E+03	2.9E+04	2.0E+04	9.9E+03	
manganese	7.8E+02	1.5E+03	1.0E+03	1.4E+03	3.0E+03	
mercury						1.2E-01
nickel	4.2E+01	3.3E+01	3.6E+01	3.3E+01	6.1E+01	
potassium	1.1E+04	6.8E+03	1.2E+04	5.9E+03	1.4E+04	
selenium	2.3E+00	1.7E+00	1.4E+00	1.6E+00	2.6E+00	
silver <sup>2</sup>					NA	4.3E-01
strontium	3.9E+02	6.2E+01	2.5E+02	NA	2.5E+02	
thallium				NA	NA	4.7E+00
vanadium				NA	NA	4.0E+01
zinc	1.6E+02	1.6E+02	1.9E+02	1.0E+02	1.7E+02	

<sup>1</sup>Not Applicable<sup>2</sup>Value for silver was derived as indicated, however a judgment regarding the validity of the maximum concentration related to data from a single laboratory resulted in removal of the data point. As a result, several elevated detection limits from the same laboratory were removed based upon application of this decision rather than on the basis of exceeding the highest measured concentration.

Figure 1: Division of Surface Water Sampling Locations and Ohio Ecoregions

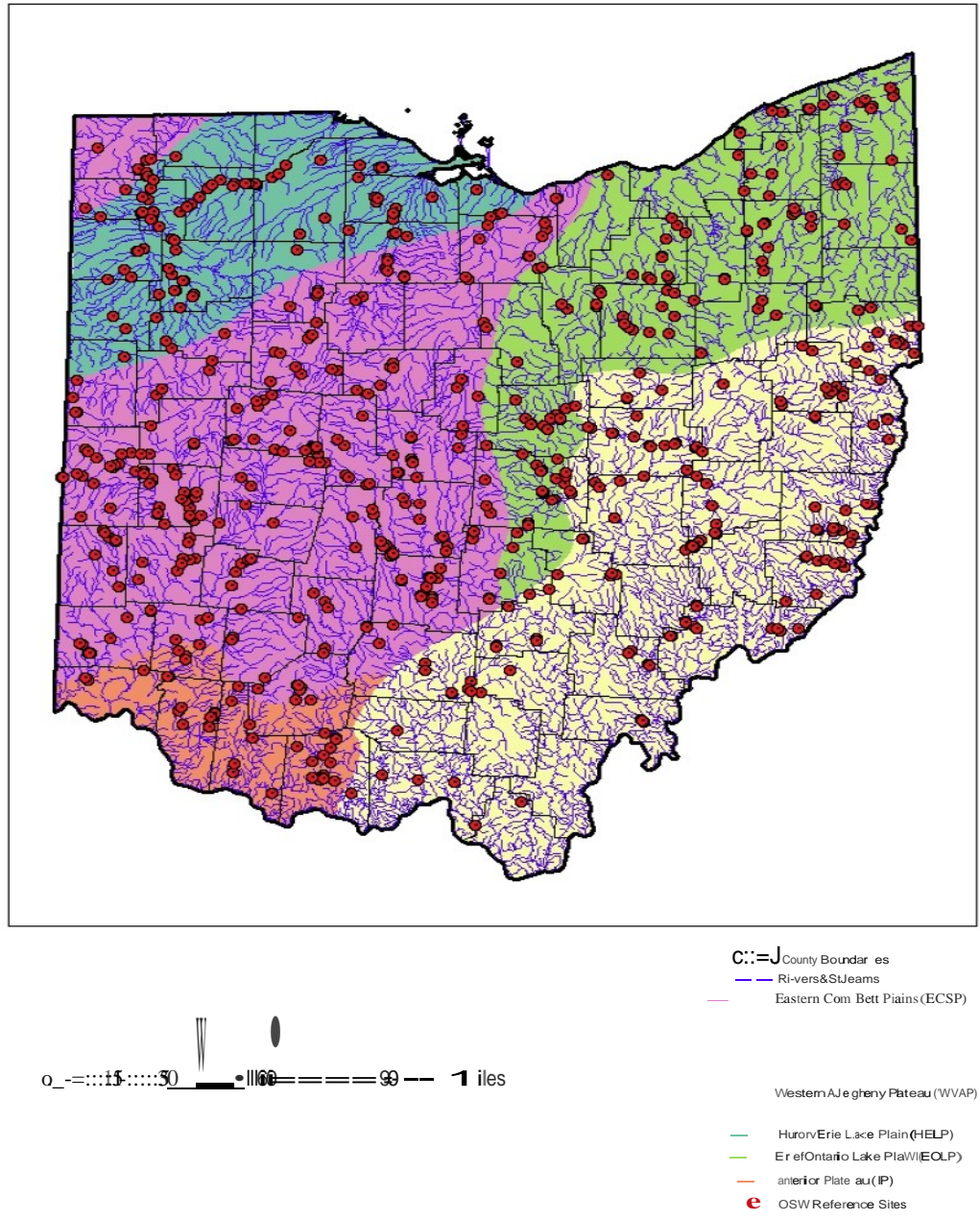

## REFERENCES

- Barrick R, Becker S, Pastorok R, Brown L, Beller H (1988) Sediment quality values refinement: 1988 update and evaluation of Puget Sound AET. Prepared by PTI Environmental Services for Environmental Protection Agency, Bellevue, WA.
- Hughes, R.M., D.P. Larsen, and J.M. Omernik (1986) Regional reference sites: a method for assessing stream pollution. *Env. Mgmt.* 10 (5): 629-635.
- Ingersoll CG, Haverland PS, Brunson EL, Canfield TJ, Dwyer FJ, Henke CE, Kemble NE, Mount DR, Fox RG (1996) Calculation and evaluation of sediment effect concentrations for the amphipod *Hyalella azteca* and midge *Chironomus riparius*. *J Great Lakes Res* 22:602-623.
- Long ER, MacDonald DD, Smith SL, Calder FD (1995) Incidence of adverse biological effects within ranges of chemical concentrations in marine and estuarine sediments. *Environ Manage* 19:81-97.
- MacDonald DD (1997) Sediment injury in the Southern California Bight: review of the toxic effects of DDTs and PCBs in sediments. Prepared for National Oceanic and Atmospheric Administration, US Department of Commerce, Long Beach CA.
- Ohio EPA (2001) Sediment Sampling Guide and Methodologies (2<sup>nd</sup> Edition). Division of Surface Water, Columbus OH.
- Ohio EPA (1999a) Ohio EPA/Heidelberg College Lake Erie Basin Sediment Project Report, Columbus, OH.
- Ohio EPA (1999b) Closure Plan Review Guidance for RCRA Facilities. Division of Hazardous Waste Management, Columbus, OH.
- Ohio EPA (1989) Ohio EPA manual of surveillance methods and quality assurance practices, updated edition. Division of Environmental Services, Columbus, Ohio.
- Ohio EPA (1987a) Biological criteria for the protection of aquatic life: Volume I. The role of biological data in water quality assessment. Division of Water Quality Monitoring and Assessment, Surface Water Section, Columbus, Ohio.
- Ohio EPA (1987b) Biological criteria for the protection of aquatic life: Volume II. Users manual for biological field assessment of Ohio surface waters. Division of Water Quality Monitoring and Assessment, Surface Water Section, Columbus, Ohio.
- Yoder, C.O. (1989) The development and use of biological criteria for Ohio surface waters. U.S. EPA, Criteria and Standards Div., Water Quality Stds. 21st Century, 1989: 139-146.
- Yoder, C.O. and E.T Rankin (1996) Assessing the condition and status of aquatic life designated uses in urban and suburban watersheds., pp.201-227. *in* Roesner, L.A. (ed). Effects of Watershed Development and Management on Aquatic Ecosystems, American Society of Civil Engineers, New York, NY.
- Yoder, C.O. and E.T. Rankin. (1995) Biological criteria program development and implementation in Ohio, pp. 109-144. *in* W. Davis and T. Simon (eds.). Biological Assessment and Criteria: Tools for Water Resource Planning and Decision Making. Lewis Publishers, Boca Raton, FL.

**Attachment I**  
**Generic Receptor Species List**

---

**Soil Associated Receptors**

Direct Soil Contact  
Plants  
Earthworms

Herbivore  
Meadow vole  
Deer mouse  
Eastern cottontail  
White-tailed deer\*

Carnivore  
Red-tailed hawk  
American kestrel  
Red fox

Invertivore  
Short-tailed shrew  
American woodcock  
American robin

**Surface Water and Wetland Associated Receptors**

Direct Surface Water/Sediment Contact  
Aquatic Plants  
Macroinvertebrates  
Fish

Herbivore  
Muskrat  
Mallard duck

Invertivore  
Spotted sandpiper

Piscivore  
Mink  
Belted kingfisher  
Great blue heron

---

\* White-tailed deer are usually only to be evaluated when public concerns have been raised regarding white-tailed deer populations.

Note: See Level III ERA guidance document, attachment A, for specifics regarding the selection of receptors for use in a Level III ERA.



## CHAPTER 4

### LEVEL III – BASELINE

#### 4.1 OBJECTIVE

The objective of a Level III baseline assessment is to estimate the potential hazards to representative endpoint species posed by chemical and non-chemical stressors identified at a site. The Level III ecological risk assessment (ERA) is designed to determine: (a) the potential and/or significant ecological effects occurring at a site as measured using a deterministic risk assessment procedure; (b) the probable stressors responsible for these effects; (c) the source of causal agents; and (d) the basis for site-specific ecological risk management decisions. The Level III assessment provides the basis for determining the need for ecological risk mitigation and provides information necessary for the development of site-specific remedial alternatives and ecological risk management practices.

#### 4.2 PREREQUISITES

Initiation of a Level III ERA requires completion of a Level I and Level II ERA coupled with a decision to proceed with further ecological investigation.

U.S. EPA has concluded that the strengths and weaknesses of ecological risk assessments in part, originate from the quality of decisions made during the problem formulation stage. It is especially important at this stage to identify and contact any stakeholders with responsibilities for and impacted by the resources being analyzed. If the affected parties do not participate in the early decisions about goals, endpoints, and measurements, the analysis is likely to fail to provide information useful for decision making. Therefore, it is strongly recommended that problem formulation (Tasks 1 and 2 below) be completed with stakeholder involvement during the initial stages of a Level III ecological assessment.

Completion of problem formulation in essence, requires the following: (a) assessment endpoints that link the risk assessment to management

concerns, (b) a Conceptual Site Model (CSM) that describes key relationships between one or more contaminant of potential ecological concern (COPEC, identified in Level II) and the assessment endpoint(s); and (c) finally, one or more risk hypotheses. All these inputs (a-c above) are factored into the analysis plan. The assessment endpoints and their associated endpoint species, preliminary risk hypotheses, conceptual site model(s), and other information developed in the Level II ERA (Tasks 7-12) should be reviewed and if necessary revised in the Level III ERA to reflect any new information or the results of further discussions among stakeholders.

The approach given in this guidance for the calculation of potential hazards to ecological receptors differs from the traditional process of iterative hazard quotient (HQ) calculations. HQ values are to be calculated once during the ecological risk assessment process using reasonable/site-specific assumptions and representative endpoint species as specified in this guidance document.

The following is a list of tasks required for the completion of a Level III-Baseline ecological risk assessment:

#### 4.3 TASKS

The following tasks are to be completed as part of a Level III ERA:

##### **4.3.1 Task 1 Complete Problem Formulation**

Problem formulation is a systematic planning step that identifies the focus and scope of the risk assessment and results in the development of a problem statement that is addressed by the Analysis Plan (Task 2) step. Typically, problem formulation includes ecosystem characterization, pathway analysis, assessment endpoint evaluation, and measurement endpoint identification. Exposure setting or habitat characterization is critical in delineating ecological receptors that may be potentially impacted by COPECs. Evaluation of ecological receptors representative of the habitats provides

the basis for selecting measurement endpoints, in addition to demonstrating the presence or absence of State or Federally-listed threatened or endangered species (T&E). This process is initiated in Level II (see Level II, Task 7, site survey; Task 8, site description; and Task 9, identify ecological receptors). Complete or potentially complete exposure pathways are also identified in Task 3 of the Level III process. Ohio EPA recommends that, as a function of the evaluation of terrestrial and aquatic ecosystems identified in previous levels, generic receptors representative of the feeding habits and habitats are modeled as discussed in the Level III Attachments A and B.

Following the screening process described in Level II, there should be a reduced number of COPECs in one or more media to evaluate. Therefore, it should be possible to better ascertain the relationship between specific COPECs, their likely pathway to specific ecological receptors, and the effect(s) they may induce in these receptors. This process should substantially lessen the chance of having inappropriate assessment endpoints and of having the assessment itself consider insignificant or implausible COPECs-pathway-receptor relationships.

As a reminder, establishing clear assessment endpoints, risk hypotheses, and their associated measures is the goal of the problem formulation task, and should enable all stakeholders to decide and agree upon a common basis for understanding what is potentially at risk at a given site. Definition of the appropriate assessment endpoints avoids making remedial decisions on the basis of trivial or insignificant effects. Therefore, once these factors have been defined, all affected parties and stakeholders should agree as to their acceptability. The assessment endpoints, hypotheses, and measurements should be modified and refined until such an agreement is achieved at which point an analysis plan can be prepared.

The Problem Formulation should consist of:

- A) Review/revise assessment endpoints  
Assessment endpoints are to be selected from the list of candidate assessment endpoints developed for Task 11 in the

Level II ERA. The final list of assessment endpoints is to be completed as part of the problem formulation step. Additional assessment endpoints may be developed and used in the Level III ERA. Assessment endpoints identified by risk managers and/or stakeholders which have little or no anticipated concern should nonetheless be carried forward in the assessment process to address specific concerns raised by the public and/or other stakeholders. See attachment A for details regarding the selection of assessment and measurement endpoints and the required generic receptors to be used for a Level III ERA.

- B) Review/revise the CSM  
A revised/updated CSM should be completed and included in the Level III report.
- C) Review/revise risk hypotheses  
The preliminary risk hypotheses stated for Task 12 of the Level II assessment are reviewed and further focused prior to designing and performing any baseline investigations. This will limit generation of data that are of little use in assessing baseline risk or in making possible future risk management decisions. As a reminder, the risk hypothesis should be written using the traditional null hypothesis format.

#### 4.3.2 **Task 2 Prepare analysis plan**

The analysis plan describes the assessment design, data needs, and methods for conducting the exposure and effects assessment components of the Level III ecological risk assessment. The analysis plan is to be completed prior to initiation of field and sampling activities. The analysis plan may be relatively brief or extensive depending on the nature of the assessment; however, it should be included as a component of the overall work plan and report for the site. The plan includes, but is not limited to, discussion of:

- Data Quality Objectives (DQOs) for the assessment, these are developed for and during the site assessment process;
- The data interpretation paradigm, *i.e.*, how measurements including sampling

and analysis of biotic and abiotic material and associated data analyses will assist in the evaluation of the risk hypotheses;

- The risk characterization options that will be used, including any weight-of-evidence techniques involving a combination of qualitative and quantitative data;
- How uncertainties in the data and analyses will be addressed;
- How the results will be presented.

#### 4.3.3 **Task 3 Perform Exposure Assessment**

Exposure assessment is the quantitative evaluation of the magnitude, frequency, duration, and route of exposure of ecological receptors to site-related environmental stressors that have been identified in Level II and carried through the site characterization process. The exposure point concentration (EPC) is the concentration of a COPEC in a specific environmental medium at the point of contact for the receptor. The point of contact is either at an outer membrane such as the dermal root membranes for plants, or through ingestion. Only exposures and therefore potential hazards through direct contact and ingestion are quantified in the Level III ERA process. Due to data limitations, exposures via inhalation and dermal contact (this is specific for most terrestrial receptors, as exposures to aquatic and terrestrial macroinvertebrates and fish are estimated holistically) are not evaluated.

For terrestrial receptors, the EPC is the soil COPEC concentration estimated using the 95% UCL of the arithmetic mean, capped at the maximum detected value. See U.S. EPA's 1992 guidance titled: Supplemental Guidance to RAGS: Calculating the Concentration Term, for specific equations for calculating the 95 % UCL of the arithmetic mean, PB92-963373. U.S. EPA's Pro UCL (<http://www.epa.gov/nerlesd1/tsc/software.htm>) may also be evaluated for calculating the concentration term.

Alternative exposure values for mobile receptors may be estimated using more spatially-explicit estimations. These types of evaluations can be made in addition to the standard uptake

equations. These types of exposure assessments can help better quantify the exposure to ecological receptors by taking into account "attractive" or unsuitable habitat. For sites completing an RI/FS or equivalent, the models and input assumptions should be reviewed and approved by Ohio EPA DERR prior to the submission of a completed risk assessment report document. This would be part of the risk assessment assumptions (RAAD) document for an RI.

The exposures to aquatic invertebrates and fish are evaluated using the chemical specific and biological criteria when appropriate. Aquatic macroinvertebrates and fish tissue COPEC concentrations are occasionally calculated using surface water and sediment EPCs or by direct tissue sampling, when adverse effects via food chain exposures are evaluated. See attachment B for details regarding estimation of fish tissue COPEC concentrations.

Exposure characterization of wildlife with large home ranges is based on the average daily dose (ADD) (*i.e.*, the dose of a chemical or COPEC ingested by an ecological receptor and expressed as the mass of a chemical ingested concentration per kilogram body weight of the receptor per day ( $\text{mg}\cdot\text{kg}^{-1}\cdot\text{day}^{-1}$ )). The ADD is analogous to the term "intake" used in human health risk assessments to estimate the dose of a compound to a human receptor.

The ADD and the EPC values for each receptor and COPEC are required to estimate risk during the risk characterization phase of the Level III ERA. Determining the EPC and ADD values requires taking into consideration a number of factors including, but not limited to, the spatial distribution of endpoint species, the distribution and concentration of COPECs, and the transfer and accumulation of COPECs in and through the various food chains. Calculating EPC or ADD values for any given ecological receptor involves the following processes:

- A) Identify ecological receptors based on the generic receptor list (Attachment A) and the revised Level II conceptual site model (CSM). The chosen ecological receptors in the Level III ERA represent the assessment endpoints finalized in task 1(A) above. Attachment A details the selection of the

ecological receptors based upon a set of generic receptors that are required for the completion of a Level III ERA. These receptors have been categorized on the basis of feeding habits and trophic level relationships. Receptors that are not included in the generic receptor list may be used in addition to the generic receptors if justification is given to support the rationale and benefits for using these receptors in the Level III ERA. If T&E species have been identified to be present at a site, or potentially impacted by site-related environmental stressors, each species should be used as an ecological receptor in the Level III ERA in addition to the required generic receptors.

- B) Estimate the EPC and ADD values for each COPEC in all appropriate media. Attachment B details the exposure characterization process and gives specific methodologies for estimating EPC and ADD values. The calculation of EPC and ADD values generally requires the following information:
- (i) Complete site characterization information. This includes concentrations of COPECs in all affected abiotic media (e.g., soil, sediment, and surface water) and biotic media (e.g., the specific tissue COPEC concentrations of potential prey species) when trophic interactions are of concern. The concentrations of COPECs in all relevant biotic media may be modeled or directly measured in non-T&E species when greater certainty is required in the Level III ERA risk estimation. The Ohio Department of Natural Resources (ODNR), Division of Wildlife should be contacted at (614)265-6300 prior to animal collection to obtain any required permits or approval. The magnitude and extent of the contamination should have been defined during the site characterization process.
  - (ii) Receptor species life history parameters (dietary component fraction, weight, home range, etc.). The life history parameters for the generic receptors can be found in Attachment D of the Level III ERA guidance document. The life history parameters listed in attachment D have been developed

based upon the average of literature values and represent reasonable values for use in the Level III ERA process.

- (iii) Physicochemical properties of the identified COPECs. This information is necessary to evaluate potential exposure routes, estimate bioconcentration and/or bioaccumulation factors, and assess the mobility and bioavailability of the identified COPECs.

Attachment B gives specific instructions and methodologies for completing the exposure characterization process. Attachment B is to be used for the calculation of EPC and ADD values for the selected ecological receptors.

#### **4.3.4 Task 4 Perform Toxicity Assessment**

COPECs that come into contact with endpoint species can induce acute or chronic adverse effects in individual organisms, or may indirectly affect their ability to survive and reproduce. Ecological effects may also be expressed as some impairment of a biological function or condition which may potentially effect populations.

The objective of the toxicity assessment (Task 4) is to evaluate the appropriate toxicity data for all COPECs and to develop an ecologically-based reference dose (ERfD) for each COPEC to be used in assessing possible harm to ecological receptors. Specific information for the development of individual ERfD values is given in Attachment C of the Level III guidance document. The following information summarizes the toxicological criteria to be used for deriving the appropriate ERfD values for the receptors used in the risk characterization (Task 5) step of a Level III ERA:

For State or Federally-listed threatened or endangered species the ERfD = Modified Chronic No Adverse Effect Level (NOAEL<sub>mc</sub>) (mg.kg<sub>bw</sub><sup>-1</sup>.d<sup>-1</sup>) adjusted to account for interspecies uncertainty and multiplied by an appropriate intraspecies uncertainty factor.

For receptors other than threatened or endangered species, the ERfD = NOAEL<sub>mc</sub> adjusted to account for interspecies uncertainty. Note that for aquatic habitats,

the biological criteria is used in evaluating population level effects on aquatic organisms. See Level II ERA guidance for specific requirements for aquatic habitats. Also note that for plants and soil invertebrates, no interspecies adjustments of the ERfD values are required.

#### **4.3.5 Task 5 Perform Risk Characterization**

Risk characterization estimates the magnitude of potential hazard to endpoint species under a specific set of circumstances. It is the process of applying numerical methods and professional judgment to determine whether acceptable levels for endpoint species are or could be exceeded as a result of exposure to site-related COPECs. Risk characterization involves two components: a quantitative and when necessary, qualitative estimation of potential harm and a narrative risk description.

Risk characterization, as a part of the ERA process, should be consistent with the values of "transparency, clarity, consistency, and reasonableness" (U.S. EPA 1995). Well-balanced risk characterizations present risk conclusions and information regarding the strengths and limitations of the risk assessment and its methods for other risk assessors, Ohio EPA DERR, and the public. The risk characterization process and the Level III ERA report is not to include or imply any approval or Agency risk management decisions but simply provide the hazard estimations from the quantitative and qualitative assessments. The risk characterization process consists of a quantitative hazard estimations shall include the following procedures:

- A) For all quantitative assessments, hazard is assessed with the use of a quotient methodology. The purpose of this calculation is to determine the level of the EPC or ADD relative to the ERfD. Thus, the environmental hazard quotient (EHQ) = (EPC or ADD)/ ERfD. An environmental hazard index (EHI) is derived by summing all appropriate EHQs (EHI) =  $\Sigma$ EHQ. Both EHQ and EHI values are rounded to one significant digit. An EHI should be calculated to determine the potential adverse effects caused by exposure to multiple COPECs

that have similar toxic endpoints (included as available, target organ, mode of action or mechanism of action). Use of an EHI assumes simple additive effects of toxic responses and does not consider other interactions such as synergism and/or antagonism. Tables 1-3, provide sample formats for listing toxicologic data, including toxic endpoints and the development of an EHI for toxicologically similar chemicals.

Table 1 Example Table Format for Toxicity Values.

Chemical	CASRN	Exposure period	Response Critical Study(ies) (mg.kg <sup>-1</sup> .day <sup>-1</sup> )	Critical Effect/target organ	Confidence	Source /date	Uncertainty Factors Used (total)	ERfD
Acenaphthene	83-32-9	subchronic	175 NOAEL	Hepatotoxicity	low	IRIS/November/1990	300	0.58
Aldrin	309-00-2	chronic	0.025 (LOAEL)	Liver toxicity	medium	IRIS/January/1991	10	0.0025
1,1-Biphenyl	92-52-4	chronic	50 (NOAEL)	Kidney damage	medium	IRIS/March/1991	30	1.7
Pentachlorophenol	87-86-5	chronic	3 (NOAEL)	Liver and kidney pathology	medium	IRIS/January/1987	scaled*	2.7
Vanadium (Vanadium pentoxide)	1314-62-1	chronic	0.89 (NOAEL)	Decreased hair cystine	low	IRIS/June/1988	scaled*	0.71

\* allometric scaling was used instead of uncertainty factors.

Table 2. Example Format for Chronic Hazard (HQ) Estimates

Chemical	CASRN	ADD (mg kg-1 day-1)	ERfD (mg. kg-1. day-1)	EHQ
Acenaphthene	83-32-9	0.91	0.58	2
Aldrin	309-00-2	0.002	0.0025	0.8
1,1-Biphenyl	92-52-4	0.13	1.7	0.08
Pentachlorophenol	87-86-5	1.6	2.7	0.6
Vanadium (Vanadium pentoxide)	1314-62-1	11.1	0.71	20

Table 3. Example Format for Hazard Index (HI) Estimates

Chemical	CASRN	Critical Effect/target organ(s)	EHQ	EHQ Liver	EHQ Kidney
Acenaphthene	83-32-9	Hepatotoxicity	2	2	
Aldrin	309-00-2	Liver toxicity	0.8	0.8	
1,1-Biphenyl	92-52-4	Kidney damage	0.08		0.08
Pentachlorophenol	87-86-5	Liver and kidney pathology	0.6	0.6	0.6
Vanadium (Vanadium pentoxide)	1314-62-1	Decreased hair cystine	16		
Total Hazard Index (EHI)				3	1

B) Risk description is a qualitative narrative discussion of the potential hazards presented by the site and must include a discussion of any toxicological and ecological factors beyond those embodied in the quantitative risk estimates. Potential hazards must be described for each COPEC-pathway-receptor combination and each assessment endpoint.

C) If required, a Level IV field baseline assessment would use field investigations to further refine the risk estimate through acquisition of the additional types of field evidence. Because no one piece of information can adequately define risks to complex ecological systems, a formal "weight-of-evidence" approach might be needed to compile and integrate various lines or types of evidence indicating the degree of hazard present for each COPEC and assessment endpoint. The two general types of evidence gathered for a field baseline ERA consist of (a) toxicity testing using abiotic media from the site, (b) ecological survey data from the site. Site surveys and interpretation of site data is a difficult task and communication with Ohio EPA DERR is required before site-specific field measurements are conducted. The field methods described above, are generally associated with a Level IV ERA

(field baseline ERA). However, if such information is available it should be included in the Level III report.

#### 4.3.6 **Task 6 Perform Uncertainty Analysis**

Quantitative estimates of the potential for adverse affects from exposure to COPECs inherently contain the artifacts of uncertainty (*i.e.*, lack of knowledge or data gaps) and variability (*i.e.*, differential expression of attributes or characteristics in a population). The uncertainty analysis summarizes assumptions made for each element of the assessment and evaluates their validity, strengths and weaknesses of the analyses, and quantifies to the greatest extent possible the uncertainties associated with each identified potential hazard. This analysis addresses uncertainty associated with each component of the baseline assessment, including but not limited to: COPEC selection and quantification, receptor selection, exposure estimation, effects estimation, and risk characterization. It is important that data gaps that may have hindered or prevented the full determination of potential risk, and which may be addressed with a Level IV assessment, be identified at this time. The uncertainty analysis is the location in the Level III report where, if desired, alternate risk calculations may also be completed to discuss

uncertainty in the risk assessment process. The uncertainty analysis is to be completed as a stand alone section of the Level III report and should not attempt or promote risk management decisions; however information that could help in the selection of the appropriate site decision may be included.

#### **4.3.7 Task 7 SMDP: Acceptable Ecological Risk Level Exceeded?**

An SMDP made at this stage of the ecological evaluation may attempt to answer this question: Based on information presented in the Level III deliverable, are any of the following acceptable levels exceeded for individuals and/or populations of endpoint species associated with the assessment endpoints? The SMDP would be based on the following information:

- A) Determination of the Acceptable Risk Level (ARL):  
The acceptable risk level is defined as the following:
  - (i) Environmental Hazard quotient (EHQ), or environmental hazard index (EHI) where appropriate of less than or equal to one (rounded to one significant figure); and,
  - (ii) No other observed significant adverse effects on the health or viability of the local individuals or populations of species are identified.
- B) Interpretation of the ARL:  
If both criteria (i and ii above) are not exceeded, then the site is highly unlikely to present significant risks to endpoint species.
- C) No Further Action:  
If both criteria (i and ii above) are not exceeded then a recommendation for no further ecological investigations should be made.
- D) Further action:  
If any criterion (i or ii above) is exceeded, then the site could present significant risks to endpoint species and a recommendation to move to the next SMDP is made. In this instance, the Level III analyses should identify (1) the COPECs that clearly pose risks below the ARL and thus require no

further action, (2) the COPECs that currently constitute risks above the ARL and thus should be subject to remediation, and (3) the COPECs that may or may not pose a significant ecological risk but, because of elevated uncertainty, should also be subject to further investigation, monitoring, risk management and/or remediation. COPECs in category (2) or (3) are termed contaminants of ecological concern (COECs) and are the focus of either further investigations or remedial actions.

#### **4.3.8 Task 8 Submit Level III Deliverable**

This deliverable is a document (see Attachment E, Baseline Risk Assessment Report, for suggested format and contents) which will provide detailed procedures regarding the basis for exposure assessment and toxicity assessment, and a thorough discussion of uncertainties inherent in the risk analyses. The results presented in this report provide the factual basis for evaluating the following SMDP. The risk assessment report should be easy to follow and understand, with all assumptions, defaults, uncertainties, professional judgments (with justifications) and any other inputs to the risk estimates clearly identified and referenced

#### **4.3.9 Task 9 SMDP: Remedial Action Decision Possible?**

Based on the results of the Level III risk assessment, risk managers will make a determination whether a response action is appropriate with existing information and current levels of uncertainty. Key questions: Would cleanup be less costly than further investigation? Are data adequate to approve a removal action or to select or approve no further action or a remedy? If "Y", then further ecological investigation is deferred in favor of a response action. If "N", then the assessment process proceeds to a Level IV ERA. It should be noted that responses to environmental contamination need to be coordinated with other potential risks (i.e., human health) and requirements for the site. This may be in the form of a comprehensive remedial investigation feasibility study (RIFS) where the final ecological risk assessment report will be included as the ecological risk assessment section.



## Attachment A

### GENERIC RECEPTORS, FOOD-WEB CRITERIA, AND DIRECT CONTACT EVALUATIONS

#### (1) Introduction

The objective of using generic receptors, food-web models, and direct contact evaluations is to estimate the magnitude of exposure to potential ecological contaminants of concern (COPECs) and the effect of those exposures on selected ecological receptors. Attachment A discusses the use, requirements, and the selection of receptors to be used in a Level III ecological risk assessment (ERA). U.S. EPA 1996, ECO Update, Ecological Significance and Selection of Candidate Assessment Endpoints, and U.S. EPA 1997, Ecological Risk Assessment Guidance for Superfund: Process for Designing and Conducting Ecological Risk Assessments, should also be reviewed before and during the selection of receptors to represent the various assessment endpoints chosen for the site. The food-web models/direct contact evaluations (section 2) lists the minimum number of required receptors and exposure pathways that must be evaluated during a level III ERA.

Food-web models quantify the transfer of COPECs from one medium to another including COPECs that may be transferred from abiotic media such as soil and surface water to and through biotic media or tissues. The food-web criteria given in Attachment A have been developed for the basic feeding habits of terrestrial and aquatic receptors and in conjunction with Attachment B (Exposure Characterization), assist in the quantification of COPEC concentrations in biological tissues that may be consumed by ecological receptors.

Direct contact evaluations estimate the potential for adverse ecological impacts to specific organisms that are intimately associated with contaminated media. More specifically, direct contact evaluations estimate adverse effects to plants, soil/aquatic invertebrates, or other organisms caused by the exposure and uptake of COPECs from contaminated media by means other than ingestion. Examples of direct contact exposures include but are not limited to; passive and active uptake of COPECs by plants, or absorption of COPECs through the outer-membranes of soil invertebrates or microorganisms. Earthworms are considered under the direct contact category even though they are exposed to soil COPECs through both dermal contact and ingestion.

In practice, ecological risk assessments generally evaluate and choose similar ecological receptors to represent various feeding guilds and trophic levels. These receptors are often chosen based on the availability of toxicity information, the abundance of the receptors, their role as potential food sources for predators, their limited home ranges, and their specific feeding habits. The generic receptors and the food-web criteria given in Attachment A reflect the most commonly used and accepted approaches and receptors for estimating ecological impacts without extensive field evaluations and expense.

#### (2) Food-web Criteria/Direct Contact Evaluations

Food-web and direct contact evaluations are required for a Level III ERA and are dependent upon the type of contamination and the affected media. Terrestrial and aquatic systems are evaluated differently and require separate consideration in the Level III ERA and report. COPECs identified in terrestrial systems are to be evaluated using both the appropriate food-web models and direct contact evaluations.

Persistent, bioaccumulative and toxic (PBT, see Level II ERA guidance) compounds are also to be evaluated using direct contact and food-web models; however, an additional level of effort is required for compounds of this classification. The additional level of effort includes the evaluation of two top food-chain predators, which is not required for non-PBT COPECs. Because PBT

compounds have the tendency to bioaccumulate or biomagnify, this additional quantification step is warranted. If multiple COPECs are encountered at a site, then only the PBT stressors are required to be evaluated by modeling the top carnivorous receptors unless chemical specific data indicates sensitivity to top carnivores.

Ohio EPA recommends the use of empirical contaminant tissue concentration data when available or when a greater amount of certainty is required in a Level III ERA. Food-web models may also be used for estimating the dose of COPECs to the generic receptors when necessary, or when a lesser amount of certainty is required for the ERA. Exposures to ecological receptors via ingestion of abiotic or biotic media are estimated by using various food-web models. Food-web models are the mathematical procedures used to quantitate the concentrations (dose) of COPECs ingested by selected receptors. These models are to include the relevant media that are potentially consumed by a receptor. Consumed media may include: soil, surface water, sediment, and biological tissues.

The accepted methods for estimating contaminant concentrations in biological media are given in Attachment (B). Attachment (D) lists the life history data for each generic receptor that are to be used in the various uptake models given in Attachment B. The selection of the food-web models is based upon the habitat (aquatic or terrestrial) that is affected and the type of contaminant. These models are to be used for organic and inorganic COPECs. Non-chemical stressors will need to be evaluated appropriately. Due to the variety of substances that can be considered as non-chemical stressors, no generic food-web models for non-chemical stressors can be developed. Instead, non-chemical stressors are to be evaluated on an as-needed basis. Discussions with risk assessment personnel from the Ohio EPA DERR are strongly encouraged before a Level III ERA is completed and submitted for approval for sites assessing the effects caused by non-chemical stressors.

The food-web criteria and direct contact evaluations that are required when evaluating terrestrial and aquatic habitats that are potentially impacted by PBT and non-PBT COPECs are given below:

- A) Terrestrial Environments:  
Terrestrial systems that do not contain PBT compounds are at a minimum, required to evaluate direct contact effects/toxicity on plants and earthworms (if sufficient information is available), and to use one herbivore and one invertivore receptor in assessing the potential impacts to ecological receptors by site-related COPECs. If PBT compounds are present then, one mammalian and one avian top carnivorous receptor must also be evaluated in addition to the receptors listed for terrestrial environments with non-PBT compounds. The specific requirements for a Level III ERA for the evaluation of terrestrial environments include:
  - 1) Non-PBT COPECs
    - i) Direct contact effects on plants (see Attachment B (2));
    - ii) Direct contact effects on soil dwelling invertebrates/microorganisms (see Attachment B (2));
    - iii) Effects on herbivorous mammals and birds (see table A-1 for list of receptors); and,
    - iv) Effects on invertivorous mammals and birds (see table A-1 for list of receptors).

- 2) PBT COPECs
  - i) All evaluations for Non-PBT COPECs; and,
  - ii) Effects on two top terrestrial carnivores (one mammal and one bird (see table A-1 for a list of receptors)). The diets of the top carnivores should include herbivorous and invertivorous small mammals or birds depending on the type of contamination at the site and feeding habits of the receptors. Generally, sites with organic PBTs should evaluate top carnivorous receptors by estimating 100% of the diets as invertivorous mammals or birds. For sites with inorganic PBTs, the top carnivores should be evaluated by estimating 100% of the prey as herbivorous mammals or birds. For sites that may have both organic and inorganic PBT compounds, a site-specific prey evaluation may be warranted to determine the appropriate proportion(s) of prey.

It should be noted that sites with active seeps or contaminated surface water may need to include the ingestion of surface water as a pathway for receptors in the Level III ERA. This pathway should only be considered when it is probable for ecological receptors to come into contact and consume contaminated surface water on a regular basis. The appropriate Ohio EPA personnel should be contacted for additional information regarding the evaluation of contaminated surface water for terrestrial environments.

- B) Aquatic Environments:

Surface waters are to meet all applicable water quality standards as given in OAC 3745-01 and discussed in the Level II ERA guidance document. A detailed description of the use of Ohio EPA water quality criteria in ecological risk assessment is given in the Level II ERA guidance document. It should be noted that much of the surface water evaluations are to be conducted or begun during the Level II ERA. The specific requirements for a level III surface water evaluation include:
- 1) Lotic water bodies (other than those designated as limited resource water (LRW):
  - i) Non-PBT COPECs:
    - a) Lotic surface waters other than those designated as limited resource water (LRW) that do not list PBT compounds as COPECs must meet the appropriate chemical specific and biological criteria given in OAC 3745-01.
  - ii) PBT COPECs:
    - a) Lotic surface waters other than those designated as limited resource water (LRW) that list PBT compounds as COPECs must meet the appropriate chemical specific and the biological criteria given in OAC 3745-01; and,
    - b) A food-web analysis must be completed that evaluates the potential risks to one piscivorous bird and one piscivorous mammal from the specific PBT compounds identified as COPECs.
- 2) Lentic and LRW surface water bodies:
  - i) Non-PBT compounds:
    - a) Lentic and LRW designated water bodies that do not list PBT compounds as COPECs must meet the chemical specific criteria listed in OAC 3745-01.

- b) Lentic or lotic water bodies designated LRW that flow into a lotic water body that is designated other than LRW must meet the appropriate chemical specific and biological criteria near or at the point of confluence;
  - c) A food-web analysis must be completed that evaluates the potential risks to one herbivorous bird and one herbivorous mammal from the specific non-PBT compounds identified as COPECs.
  - d) Sediment toxicity tests are to be conducted to evaluate potential sediment toxicity to aquatic macroinvertebrates and/or fish. At a minimum sediment bioassays must include the *Hyalella azteca* and the *Chironomus tentans* ten day bioassay conducted following the procedures in the U.S. EPA Methods for Measuring the Toxicity and Bioaccumulation of Sediment-associated Contaminants with Freshwater Invertebrates, Second Edition, EPA 600/R-99/064, March 2000. *Chironomus riparius* may be substituted for *Chironomus tentans* if needed. Prior to conducting any bio assay, it is recommended that Ohio EPA be contacted. In cases for sites completing work under an RI/FS the work plan must be approved prior to conducting the bioassays.
- ii) PBT compounds:
- a) Lentic and LRW designated water bodies that list PBT compounds as COPECs must meet the chemical specific criteria listed in OAC 3745-01.
  - b) Lentic or lotic water bodies designated LRW that flow into a lotic water body that is designated other than LRW must meet the appropriate chemical specific and biological criteria near or at the point of confluence;
  - c) A food-web analysis must be completed that evaluates the potential risks to one herbivorous bird and one herbivorous mammal from the specific non-PBT compounds identified as COPECs. And food-web analysis must also be completed that evaluates the potential risks to one piscivorous bird and one piscivorous mammal from the specific PBT compounds identified as COPECs (surface water or sediment to fish to piscivorous bird and animal model); and,
  - d) Sediment toxicity tests are to be conducted to evaluate potential sediment toxicity to aquatic macroinvertebrates and/or fish. At a minimum sediment bioassays must include the *Hyalella azteca* and the *Chironomus tentans* ten day bioassay conducted following the procedures in the U.S. EPA [Methods for Measuring the Toxicity and Bioaccumulation of Sediment-associated Contaminants with Freshwater Invertebrates](#), Second Edition, EPA 600/R-99/064, March 2000. *Chironomus riparius* may be substituted for *Chironomus tentans* if needed. Prior to conducting any bioassays, it is recommended that Ohio EPA be

contacted. In cases for sites completing work under an RI/FS the work plan must be approved prior to conducting the bioassays.

### (3) Generic Receptors

Table A-1 lists the generic receptors under their appropriate feeding habits to be used in a Level III ERA. The receptors are to be chosen based upon the assessment endpoints, the types of habitats that are associated with the site and the feeding habits of the receptors required for Level III ERA. The actual choice of the specific receptors may vary based upon the toxicity information that is available for each COPEC receptor combination and site-specific information. Attachment C of the Level III ERA guidance document discusses the toxicity assessment and the implications of selecting a receptor with adequate toxicity information. Attachment C and the appropriate toxicological data bases should be reviewed before selecting the receptors for a Level III ERA.

Table A-1  
Generic Receptor List

#### Soil Associated Receptors

##### Direct Soil Contact

Plants

Earthworms

##### Herbivore

Meadow vole

Deer mouse

Eastern cottontail

White-tailed deer\*

##### Carnivore

Red-tailed hawk

American kestrel

Red fox

##### Invertivore

Short-tailed shrew

American woodcock

American robin

#### Surface Water and Wetland Associated Receptors

##### Direct Surface Water/Sediment Contact

Aquatic Plants

Macroinvertebrates

Fish

##### Herbivore

Muskrat

Mallard duck

##### Invertivore

Spotted sandpiper

##### Piscivore

Mink

Belted kingfisher

Great blue heron

\* White-tailed deer are usually only evaluated when public concerns have been raised regarding white-tailed deer populations.

It is recommended that the receptor with the smallest home range be selected for assessing ecological risk at a site. White-tailed deer are generally not used as ecological receptors due to their large home range unless there is a concern from the public that is specific to deer population health. If white-tailed deer are to be included in a terrestrial risk assessment, then the assessment must also include a terrestrial herbivore with a smaller home range (e.g., meadow vole). By using receptors with limited home ranges additional certainty is added to the risk assessment to ensure that a site is protective or does not pose unacceptable hazard to ecological receptors.

All terrestrial State and/or Federally-listed threatened and endangered species (T&E) identified to inhabit or be potentially impacted by the site are to be included as ecological receptors in the Level III ERA. If by using the identified T&E species in the Level III ERA one or more of the feeding habits are evaluated, then the generic receptors that represent those particular feeding habits would not be required. If for example a barn owl was identified on site and used to estimate potential adverse effects to top carnivorous birds, then an assessment using either the red-tailed hawk or the American kestrel would not be required.

Aquatic T&E species are to be evaluated using the biological criteria where appropriate. If the biological criteria cannot be used to evaluate the potential impacts to aquatic T&E species, the Ohio EPA DERR is to be contacted to determine the appropriate methodology for the estimation of potential hazards to these receptors prior to completing the Level III ERA.

## Attachment B EXPOSURE ASSESSMENT

### (1) Introduction

Exposure is defined as the co-occurrence or contact between a stressor and an ecological receptor. Exposure assessment is the process of estimating the magnitude, frequency and duration of a site-specific exposure and the dose of a chemical received by an ecological receptor. For relatively sessile organisms such as plants and soil invertebrates/microorganisms, the exposure characterization is based on exposure point concentrations (EPC) (*i.e.*, the concentration of a chemical in a specific environmental medium at the point of contact for the receptor) and potential harm is assessed as a direct contact evaluation. Because plants and soil invertebrates are relatively sessile, the concentration of a chemical at a given location is likely to be representative of the chronic exposure concentration for these organisms.

Mobile wildlife exposure characterizations are based on the average daily dose (ADD) (*i.e.*, the dose of a chemical or COPEC ingested by an ecological receptor and expressed as the mass of a chemical ingested concentration per kilogram body weight of the receptor per day ( $\text{mg.kg.bw}^{-1}.\text{day}^{-1}$ ). Calculation of wildlife ADDs incorporates exposure point concentrations derived from (1) modeled concentrations of chemicals in food items such as terrestrial plants, terrestrial invertebrates, terrestrial prey species, aquatic invertebrates, and fish, and (2) measured concentrations of chemicals in surface soil, surface water and biological media (tissues). If measured tissue concentrations are used to characterize exposure, sampling methodologies should be reviewed and approved by Ohio EPA DERR prior to tissue collection and analysis. Direct sampling is recommended when greater certainty is required for the risk assessment.

The primary route of exposure of COPECs to wildlife receptors is the ingestion of food and water which includes the ingestion of surface soil and sediment incidentally consumed during feeding and/or grooming. The following text summarizes the EPC and ADD methodologies for ecological receptors evaluated in an ecological risk assessment.

### (2) Direct Contact Evaluation

Direct contact evaluations estimate potential impact to soil invertebrates and plants as the result of exposure to site-related COPECs. Sites that contain potentially impacted soils are to evaluate possible adverse impacts to plants and soil invertebrates. This evaluation is performed by comparing measured concentrations of site-related COPECs to the appropriate toxicological dose response data (see Attachment C (1)).

### (3) Quantification of Exposure via Ingestion (Average Daily Dose)

The exposure of an ecological receptor to COPECs in surface soil, sediment, tissues, and surface water are quantified as the average daily dose (ADD). The ADD is estimated using measured or modeled concentrations in environmental media and receptor life history parameters. The ADD equations account for both the transfer of constituents from abiotic media into food or prey items and for direct up-take of contaminated media by the ecological receptors.

The concentration of COPECs used in the exposure calculations is defined as the exposure point concentration (EPC). The EPC is the lower of the 95% upper confidence limit (UCL) on the arithmetic mean or maximum detected concentration of the COPECs for all media in Level III.

The quantity of food ingested by a receptor, normalized by body weight, is defined as the daily rate of food ingested ( $\text{NIR}_f$ ), given in units of  $\text{g.g}_{\text{bw}}^{-1}.\text{d}^{-1}$ . The  $\text{NIR}_f$  is the combination of all intakes for the receptor. These intakes consist of the ingestion rate, or the quantity of food ingested that is plant matter ( $\text{NIR}_P$ ), animal matter ( $\text{NIR}_A$ ) and soil ( $\text{NIR}_S$ ). These ingestion values are calculated by multiplying the  $\text{NIR}_f$  by the fractions of the diet that are plant matter ( $P_F$ ),

animal matter ( $A_F$ ) and soil ( $S_F$ ). Life history parameters for the generic receptors are given in Attachment D.

Ecological receptors obtain all or a fraction of their diet from the exposure site. The amount of exposure a receptor would receive from the site is dependent upon the size of the site or area of contamination, and the home range of the receptor. Assuming that individual receptors are randomly distributed over their home range and/or forage randomly over their home or foraging ranges, they obtain only a fraction of their diet from an exposure area that is smaller than their range. The area use factor (AUF) is the ratio of the size of the home range or foraging ranges to the size of the exposure area or site (see attachment D for generic receptor home range values). The temporal use factor (TUF) is the time spent present at the site or the time spent foraging at the site. TUFs are used to estimate the time migratory species spend at the site, or to incorporate site specific factors that limit the time ecological receptors are expected to be present at the site. One example for using a TUF includes the duration a site is inundated by water due to annual river flooding events. Site-specific and/or receptor-specific information should be provided for calculated exposures using a TUF of less than one.

The general ADD equation is:

$$\text{Exposure} = \text{Total Average Daily Dose} = \text{ADD}_P + \text{ADD}_A + \text{ADD}_S \times \text{AUF} \times \text{TUF}$$

where:

$\text{ADD}_P$  = Average daily dose by ingestion of plant matter ( $\text{mg.kg}_{\text{bw}}^{-1}.\text{d}^{-1}$ );  
 $\text{ADD}_A$  = Average daily dose by ingestion of animal matter ( $\text{mg.kg}_{\text{bw}}^{-1}.\text{d}^{-1}$ );  
 $\text{ADD}_S$  = Average daily dose by ingestion of soil ( $\text{mg.kg}_{\text{bw}}^{-1}.\text{d}^{-1}$ );  
 AUF = Area use factor (unitless); and,  
 TUF = Temporal use factor (unitless).

The specific ADD(x) equations are divided into plant, animal, and soil categories for discussion and are as follows:

A) Ingestion of Plant Matter (e.g., Meadow vole)

$$\text{ADD}_P = \text{EPC} \times \text{NIR}_P \times \text{UF}_{r \text{ or } v}$$

EPC = Exposure point concentration in soil ( $\text{mg.kg}_{\text{soil}}^{-1}$ )  
 $\text{NIR}_P$  = Ingestion rate of plant matter ( $\text{kg.kg}_{\text{bw}}^{-1}.\text{d}^{-1}$ ), see below,  
 $\text{UF}_{r \text{ or } v}$  = Soil-to-plant uptake factor ( $\text{UF}_r$  reproductive or storage parts, or  $\text{UF}_v$  vegetative parts depending on the contaminant and feeding habit of receptor) uptake factor ( $\text{kg}_{\text{soil}}.\text{kg}_{\text{plant}}^{-1}$ ), see section 4.0  
 $\text{NIR}_P$  =  $\text{NIR}_f \times P_F$   
 $\text{NIR}_f$  = Ingestion rate of food ( $\text{kg.kg}_{\text{bw}}^{-1}.\text{d}^{-1}$ , IRf values for the generic receptors are given in Attachment D in units of ( $\text{g.g}_{\text{bw}}^{-1}.\text{d}^{-1}$ ) which are equivalent)  
 $P_F$  = Fraction of diet that is plant matter (unitless,  $P_F$  values for the generic receptors are given in Attachment D)



## B) Ingestion of Animal Matter

## (i) Invertivore (e.g., Short-tailed shrew, American robin, etc.)

$$ADD_A = EPC \times NIR_A \times BAF_i$$

EPC	=	Exposure point concentration in soil ( $\text{mg} \cdot \text{kg}_{\text{soil}}^{-1}$ )
$NIR_A$	=	Ingestion rate of animal matter ( $\text{kg} \cdot \text{kg}_{\text{bw}}^{-1} \cdot \text{d}^{-1}$ ), see below,
$BAF_i$	=	Soil-to-soil dwelling invertebrates uptake factor ( $\text{kg}_{\text{soil}} \cdot \text{kg}_{\text{tissue}}^{-1}$ , see section 5.0)
$NIR_A$	=	$NIR_f \times A_F$
$NIR_f$	=	Ingestion rate of food ( $\text{kg} \cdot \text{kg}_{\text{bw}}^{-1} \cdot \text{d}^{-1}$ , IRf values for the generic receptors are given in Attachment D in units of ( $\text{g} \cdot \text{g}_{\text{bw}}^{-1} \cdot \text{d}^{-1}$ ) which are equivalent)
$A_F$	=	Fraction of diet that is animal matter (unitless, $A_F$ values for the generic receptors are given in Attachment D)

## (ii) Ingestion of tissues by terrestrial Carnivores (e.g., Red tailed Hawk, Red fox)

The ADD equations for terrestrial carnivores are simply the summation of the prey ADD equations with the appropriate  $BAF_P$  values to account for the uptake of COPECs into prey tissues. Many terrestrial carnivores will prey upon both carnivorous and herbivorous small mammals and birds. However, organic PBT compounds may be evaluated by assuming the prey items are all invertivorous. Similarly, for inorganic PBT compounds, it would be protective to assume all prey species as herbivorous. A site-specific prey analysis could be conducted to reduce the uncertainty of the dietary exposure to top carnivores. It is generally assumed that all exposures to prey species are from contaminated locations year round (i.e., AUF and TUF =1). There may be rare circumstances where limited amounts of contamination (by area) may justify the use of an AUF or TUF of less than one for the prey. The use of an AUF and TUF values of less than one for prey species should be approved by Ohio EPA DERR prior to the completion of the Level III ERA.

$$ADD_A = (\text{Concentration in prey, Cs}) \times NIR_{a(\text{predator})}$$

Cs	=	Prey $ADD_{\text{Total}} \times BAF_P / IR_f$
Prey $ADD_{\text{Total}}$	=	Prey $ADD_P + \text{Prey } ADD_A + ADD_S$
Prey $ADD_P$	=	$EPC \times UF_{v \text{ or } r} \times NIR_P \times AUF \times TUF$ (see section 4.0)
Prey $ADD_A$	=	$EPC \times BAF_i \times NIR_A \times AUF \times TUF$ (see section 6.0)
Prey $ADD_S$	=	$EPC \times NIR_S \times AUF \times TUF$ (see section (3.0)C)

where:

$NIR_{A(\text{predator})}$	=	Ingestion rate of animal matter ( $\text{kg} \cdot \text{kg}_{\text{bw}}^{-1} \cdot \text{d}^{-1}$ ) = $NIR_f \times A_F$
$NIR_f$	=	Ingestion rate of food ( $\text{kg} \cdot \text{kg}_{\text{bw}}^{-1} \cdot \text{d}^{-1}$ ), $NIR_f$ values for the generic receptors are given in Attachment D in units of ( $\text{g} \cdot \text{g}_{\text{bw}}^{-1} \cdot \text{d}^{-1}$ ) which are equivalent) these values are species specific
$A_F$	=	Fraction of diet that is animal matter (unitless, $A_F$ values for the generic receptors are given in Attachment D)

BAF <sub>P</sub>	= Food-to-tissue uptake factor in prey ( $\text{kg}_{\text{prey's food}} \cdot \text{kg}_{\text{tissue}}^{-1}$ )
EPC	= Exposure point concentration in soil ( $\text{mg}_{\text{COPEC}} \cdot \text{kg}_{\text{soil}}^{-1}$ )
UF <sub>r or v</sub>	= Soil-to-plant uptake factor (UF <sub>r</sub> reproductive or storage parts, or UF <sub>v</sub> vegetative parts depending on the contaminant and feeding habit of receptor) uptake factor ( $\text{kg}_{\text{soil}} \cdot \text{kg}_{\text{plant}}^{-1}$ )
NIR <sub>P</sub>	= Ingestion rate of plant matter by prey species ( $\text{kg} \cdot \text{kg}_{\text{bw}}^{-1} \cdot \text{d}^{-1}$ )
AUF	= Area use factor of the prey species (unitless)
TUF	= Temporal use factor of the prey species (unitless)
BAF <sub>i</sub>	= Soil-to-soil dwelling invertebrates uptake factor ( $\text{kg}_{\text{soil}} \cdot \text{kg}_{\text{tissue}}^{-1}$ , see section 5.0)
NIR <sub>A</sub>	= Ingestion rate of animal matter by prey species ( $\text{kg} \cdot \text{kg}_{\text{bw}}^{-1} \cdot \text{d}^{-1}$ )
NIR <sub>S</sub>	= Ingestion rate of soil by prey species ( $\text{kg} \cdot \text{kg}_{\text{bw}}^{-1} \cdot \text{d}^{-1}$ )

## (iii) Ingestion of tissues by Piscivorous Receptors

For piscivorous receptors, the diet is assumed to consist of 100% fish. Fish tissue concentrations collected in Level II should be measured directly when possible, or modeled when tissue concentration data are not available. The ADD equation below is for estimating the average daily dose to the avian piscivorous receptors. If a mammalian receptor is used the dose of the sediment/soil may be incorporated by adding the ADD<sub>S</sub> term as discussed in the equation for the terrestrial carnivore (section (3)(B)(ii) above). The following ADD<sub>A</sub> equation is to be used for estimating the ADD of fish tissue when fish tissue data are not available:  

$$\text{ADD}_A = \text{EPC} \times \text{NIR}_A \times \text{BAF} \text{ (BAF, BSAF, or BCF)}$$

Where:

EPC	= Exposure point concentration in surface water ( $\text{mg} \cdot \text{L}^{-1}$ ) or sediment ( $\text{mg} \cdot \text{kg}^{-1}$ )
NIR <sub>A</sub>	= NIR <sub>f</sub> x A <sub>F</sub>
NIR <sub>f</sub>	= Ingestion rate of food ( $\text{kg} \cdot \text{kg}_{\text{bw}}^{-1} \cdot \text{d}^{-1}$ , NIR <sub>f</sub> values for the generic receptors are given in Attachment D in units of ( $\text{g} \cdot \text{g}_{\text{bw}}^{-1} \cdot \text{d}^{-1}$ ) which are equivalent)
BAF	= Surface water to fish (BCF, $\text{L} \cdot \text{kg}^{-1}$ ), or sediment to fish concentration factor (BAF, BSAF, $\text{L} \cdot \text{kg}_{\text{fish tissue}}^{-1}$ )
A <sub>F</sub>	= Fraction of diet that is animal (fish) matter (unitless, A <sub>F</sub> values for the generic receptors are given in Attachment D)

If the recommended fish tissue data are available, then the EPC and the BAF variables are replaced with the fish tissue wet weight COPEC concentration data (*i.e.*,  $\text{ADD}^A = \text{EPC} \times \text{NIR}_A$ )

## C) Ingestion of Soil

$$\text{ADD}_S = \text{EPC} \times \text{NIR}_S$$

$$\text{EPC} = \text{Exposure point concentration in soil (mg}_{\text{COPEC}} \cdot \text{kg}_{\text{soil}}^{-1})$$

NIR <sub>s</sub>	=	Normalized ingestion rate of soil (kg <sub>soil</sub> .kg <sub>bw</sub> <sup>-1</sup> .d <sup>-1</sup> ), = NIR <sub>f</sub> x S <sub>F</sub>
NIR <sub>f</sub>	=	Ingestion rate of food (kg.kg <sub>bw</sub> <sup>-1</sup> .d <sup>-1</sup> , NIR <sub>f</sub> values for the generic receptors are given in Attachment D in units of (g.g <sub>bw</sub> <sup>-1</sup> .d <sup>-1</sup> ) which are equivalent)
S <sub>F</sub>	=	Fraction of diet that is soil (unitless, S <sub>F</sub> values for the generic receptors are given in Attachment D)

#### (4) Determination of Plant Tissue COPEC Concentration

Plant COPEC concentrations can be either directly measured from plant tissues, or be modeled using one of several uptake equations. Direct sampling of plant tissues is recommended when greater certainty is required for the risk assessment. Plant COPEC concentrations may be estimated by using the appropriate bioaccumulation factor for the type of COPEC and plant tissue. Bioaccumulation factors for plants (BAF<sub>r or v</sub>) are used in the ADD<sub>P</sub> equation for estimating the plant tissue COPEC concentrations and ultimately, the dose of COPEC received by an herbivore from consuming plant tissue.

In general, the soil-to-plant BAF<sub>r or v</sub> for inorganic compounds are derived from the literature (e.g., Baes *et al.*, 1984) and organic BAF<sub>v</sub> are derived by using a model based upon the octanol-water partition coefficient of the organic COPEC (Travis and Arms, 1988).

Baes *et al.* (1984) conducted an extensive literature review and identified soil-to-plant BAF values which represent the ratio of the dry weight concentration of elements in plant tissue to the dry weight concentration of elements in the root zone soils. These values are given for both vegetative and reproductive portions of plants. The appropriate uptake factors should be chosen based on the ecological receptors used in the assessment. If a receptor predominantly consumes vegetative portions of plants, then BAF<sub>v</sub> values should be used to estimate the COPEC tissue concentrations. If a receptor consumes fruits and seeds, then the reproductive uptake factor or BAF<sub>r</sub> values should be used in estimating fruit and seed COPEC concentrations. If uptake values are not available in the listed sources, and are needed to conduct a Level III ERA, then Ohio EPA should be consulted for acceptable BAF<sub>r or v</sub> values or sources of information.

Organic chemicals may enter the plant by partitioning from contaminated soil to the roots and then translocated throughout the plant via the xylem tissue. Most bioaccumulative, lipophilic organic chemicals partition to the epidermis of the root or adhere to soil particles and are not drawn into the inner root or xylem (Paterson *et al.*, 1990). Plant bioaccumulation factors for estimating concentration of hydrophilic organic chemicals can be derived from the following equation based on a linear regression of bioaccumulative factors for 29 organic chemicals (Travis and Arms, 1988):

where:

$$B_v = 10^{1.588} / K_{ow}^{0.578}$$

alternatively stated;

$$(\text{Log } B_v = 1.588 - 0.578 \text{ Log } K_{ow})$$

$$B_v = UF_v$$

$$UF_v = \text{Plant uptake factor (kg}_{soil} \text{ kg}_{plant}^{-1})$$

$$K_{ow} = \text{Octanol water coefficient}$$

This methodology is expressed as a  $BAF_V$  for the vegetative portions of plants. It may be necessary to use this methodology to develop a  $BAF_I$  for estimating organic COPEC concentrations in reproductive and storage tissues if other information is not available.

It should be noted that most uptake factors are expressed in terms of dry weight of plant matter. The calculated plant tissue COPEC concentrations must therefore be converted to wet weights for use in the  $ADD_P$  equations by multiplying the results by the appropriate conversion factor (CF). See section 8 for information on converting dry weight to wet weight. A percent moisture value of approximately 85% is recommended for vegetative plant portions; for seed and grains, assume 10 % moisture (U.S. EPA, 1993).

#### (5) Determination of Earthworm Tissue COPEC Concentration

Earthworm tissue COPEC concentrations can be either directly measured from earthworm tissues, or be modeled using a bioaccumulation factor for soil invertebrates ( $BAF_I$ ). Direct sampling of earthworm tissues is recommended when a greater level of certainty is required for the risk assessment. During field sampling for earthworm tissue, it is recommended that co-located soil samples be taken to help in the determination of a site specific soil-to-earthworm bioaccumulation factor for use in potential soil remediation goals.

The following hierarchy of references is to be used for obtaining acceptable  $BAF_I$  values or methodologies for estimating  $BAF_I$  values:

- 1) Sample *et al.* 1999;  
Sample *et al.*, 1999, lists  $BAF_I$  values for As, Cd, Cr, Cu, Hg, Mn, Ni, Pb, Zn, PCB, and TCDD.
- 2) Beyer and Stafford, 1993;  
 $BAF_I$  values for Al, B, Ba, Be, Fe, Mg, Mo, Sr, and Vn and for 24 individual polycyclic aromatic hydrocarbons (PAHs) are given in Beyer and Stafford, 1993. When the  $BAF_I$  values from Beyer and Stafford 1993 are used, it is important to note that the uptake values were estimated with non-depurated earthworms. Therefore, the earthworm soil gut contents were included with the tissue analysis for the various inorganic and organic compounds. When these values are used in an ADD equation, the soil consumption term,  $I_S$  for the earthworm consuming predator only, should be eliminated.
- 3) Connell and Markwell, 1990;  
The three phase model of Connell and Markwell is to be used to estimate  $BAF_I$  values for organic compounds not listed in the above references. The specific equation is as follows:

$$BF = (y_L/x f_{oc}) k_{ow}^{b-a}$$

Where:

BF	=	$BAF_I$
$y_L$	=	Organism lipid content (0.01 (earthworm), Rao and Davidson, 1980, Belfroid <i>et al.</i> , 1993)
x	=	Proportionality constant (0.66, Rao and Davidson, 1980)
$f_{oc}$	=	Fraction of organic carbon in soil
$k_{ow}$	=	Octanol to water partition coefficient for the organic COPEC
b-a	=	Non-linearity constant (0.07)

Additional methodologies may be used to estimate  $BAF_I$  with pre-approval from Ohio EPA DERR ecological risk assessors.

Many of the  $BAF_I$  equations and values are expressed in terms of dry weight of earthworm tissue. The results of the earthworm tissue COPEC concentration estimations must be converted to wet weight or live weight for use in the ADD equations. See section 8 for information on converting dry weight to wet weight. A percent moisture value of approximately 87% is recommended for earthworms (U.S. EPA 1993 [Wildlife Exposure Handbook](#), derived from Markwell et al., (1989)).

**(6) Determination of Prey Tissue COPEC Concentrations**

Prey COPEC concentrations can be either directly measured from captured prey, or be modeled using the uptake equation described below. Direct sampling of tissues is recommended when greater certainty is required for the risk assessment. Bioaccumulation factors for prey ( $BAF_P$ ) are used in the  $ADD_P$  equation for estimating the prey tissue COPEC concentrations and ultimately, the dose of COPEC received by a top predator from the consumption prey.

$BAF$  values for inorganic compounds can be found in section 2.3 titled; Ingestion-to-Beef Parameter,  $F_i$ , in Baes *et al.* (1984). The transfer values are representative of the fraction of the daily elemental intake in feed which transferred to and remains in a kilogram of beef until slaughter.

One method for estimating  $BAF_P$  values has been described by Travis and Arms, 1988 based on the transfer of organic compounds in feed to beef. The equation is as follows:

$$\text{Log Bb} = -7.6 + \text{Log } k_{ow}$$

Where;

Bb	=	$BAF_P$
$k_{ow}$	=	Octanol to water partition coefficient for the organic COPEC

If empirically derived  $BAF_P$  values can be obtained, then they may be used in the ERA following approval from Ohio EPA DERR.

It is important to note that the equation for determining  $BAF_P$  for organic compounds is based on a dry-weight intake of the prey species and the resulting estimate of tissue COPEC concentration is also based on a dry weight measurement. Therefore, dry-weight-to-wet weight conversions should not be performed until the prey tissue COPEC has been estimated in terms of dry-weight. A percent moisture value of approximately 68% (EPA, 1993) is recommended for small mammals.

**(7) Determination of Fish and Aquatic Macroinvertebrate Tissue COPEC Concentration**

Tissue COPEC concentrations for fish and aquatic macroinvertebrates can be either directly measured from captured organisms, or be modeled using the methods described below. Direct sampling of tissues is recommended when greater certainty is required for the risk assessment.

Given that sampling of macroinvertebrates and fish communities are required for lotic water bodies being evaluated for attainment of the appropriate aquatic life habitat use designation, tissue sampling is the recommended method for evaluating tissue COPEC concentrations of these organisms.

Fish and macroinvertebrate tissue COPEC concentrations may also be estimated using an appropriate bioaccumulation factor (BAF) multiplied by the appropriate sediment or surface COPEC concentration. The methodologies for deriving the appropriate BAF values are those found in OAC 3745-1-37, and are consistent with the methods described in U.S. EPA's, [Great Lakes Water Quality Initiative Technical Support Document for the Procedure to Determine Bioaccumulation Factors](#), March 1995, EPA-820-B-95-005, and in the [Great Lakes Water Quality Initiative Technical Support Document for Wildlife Criteria](#), March 1995, EPA-820-B-95-009. These documents give explicit details for calculating bioconcentration, bioaccumulation, biota-sediment accumulation factors, and the use of food-chain multipliers. It should be noted that contaminant tissue concentrations estimated using these methods may be overestimated when compared to direct tissue sampling results.

U.S. EPA discusses that the BAF (Bioaccumulation Factor) is a better predictor of the concentration of a chemical within fish tissue in the Great Lakes System because it includes consideration of the uptake of contaminants from all routes of exposure. This is in contrast to the use of a BCF (Bioconcentration Factor) that only estimates uptake of chemical in surface water.

The cited guidance documents and OAC include a hierarchy of three methods for deriving BAFs for COPECs:

- 1) field-measured BAFs;
- 2) predicted BAFs derived by multiplying a laboratory-measured BCF by a food chain multiplier; and,
- 3) BAFs predicted by multiplying a BCF calculated from the  $\log K_{ow}$  by a food-chain multiplier.

This hierarchy has been modified to include the methodology for predicting a BAF based on a BSAF as the second method. It is presumed that the BSAF will be multiplied by a food chain multiplier. This however is not directly stated in the U.S. EPA guidance documents.

Bioaccumulation values are also available in the U.S. EPA document: [Screening Level Ecological Risk Assessment Protocol for Hazardous Waste Combustion Facilities](#), August 1999, EPA530-D-99-001A.

It is important to note that many of the BCF, BSAF, and BAF equations are based on dry-weight measurements of either sediment or tissue COPEC concentrations. Therefore, dry-weight to wet-weight conversions may need to be performed. A percent moisture value of approximately 79% (EPA, 1993) is recommended for aquatic invertebrates. A value of 75% moisture is recommended for bony fish (EPA, 1993).

**(8) Dry-weight to wet-weight Conversions**

Much of the environmental data that will be gathered from the site will be presented on a dry weight basis. Many analytical procedures require that all media samples be dried before the chemical extraction procedures can be completed. The result from these analytical processes is generally some expression of concentration of a COPEC in a medium based on a dry weight. Because the food intake rates of ecological receptors are based on wet weights of ingested materials, a dry weight to wet weight conversion step is required before the ADD equations are completed. Equations for a converting between dry and wet weight concentrations are presented below. Percent moisture values are listed in sections 4 through 7.

Conversions:

Wet weight = (dry weight) (1 - (percent moisture/100))

Dry weight = (wet weight)/(1 - (percent moisture/100))

Example:

0.8 mg.kg<sup>-1</sup>(dw) of a compound in a bony fish equals 0.2 mg.kg<sup>-1</sup> (ww)  
assuming 75% moisture

Wet weight = (dry weight) (1 - (percent moisture/100))

0.2 mg.kg<sup>-1</sup> (ww) = (0.8 mg.kg<sup>-1</sup>(dw)) (1-75/100)

Most BAF values and uptake factors are expressed in terms of dry weight of tissue and media (soil and sediment) concentrations. Therefore, the BAF and uptake values are to be used to estimate COPEC concentrations in the appropriate tissues based in terms of dry weight before the dry weight to wet weight conversions are completed. Once the concentration of the COPECs in the appropriate tissues is expressed in terms of wet weights, then the values can be used in the ADD equations.

**Literature Cited**

Baes, C.F. III, R.D. Sharp, A.L. Sjoreen, and R.W. Shor, 1984, A review and analysis of parameters for assessing transport of environmentally released radionuclides through agriculture. ORNL-5786. Oak Ridge National Laboratory, U.S. Department of Energy, Oak Ridge, TN.

Belfroid, A., M. van den Berg, W. Seinen, J. Hermens, and K. van Gestle, 1995, Uptake, bioavailability and elimination of hydrophobic compound in earthworm (*Eisenia andre*), Environ. Toxicol. Chem. 14:605-612.

Belfroid, A., A. Van Wezel, M. Shikken, K. Van Gestel, W. Seinen, and J. Hermans, 1993, The toxicokinetic behaviour of chlorobenzenes in earthworms (*Eisenia andre*), experiments in water, Ecotoxicol. Environ. Saf. 25:154-15.

Beyer, W.N. and C. Stafford, 1993, Survey and evaluation of contaminants in earthworms and in soils derived from dredged material at confined disposal facilities in the Great Lakes region, Environmental Monitoring and Assessment, 24:151-165.

Chapman, P., 1989, Current approaches to developing sediment quality criteria. Environmental Toxicology and Chemistry, Volume 8, pp. 589-599.

Connell, D.W., and R.D. Markwell, 1990, Bioaccumulation in the soil to earthworm system, *Chemosphere*, vol. 20, nos. 1-2, 91-100.

Markwell, R.D., D.W. Connell, and A.J. Gabric, 1989, Bioaccumulation of lipophilic compounds from sediment by oligochaetes, *Wat. Res.* 23:1443-1450.

Paterson, S., D. Mackay, D. Tam, and W.Y. Shiu, 1990, Uptake of organic chemicals by plants: A review of processes, correlations and models, *Chemosphere*, Vol. 21, No. 3, pp 297-331.

Rao, P.S.C. and J.M. Davidson, 1980, "Estimation of pesticide retention and transformation parameters required in nonpoint source pollution models," In: Overcash, M.R. and Davidson, J.M. (ed.) *Environmental Impact of Nonpoint Sources Pollution*. Ann Arbor Science Pub., Ann Arbor, MI.

Sample, B.E., G.W. Suter II, J.J. Beauchamp, and R.A. Efroymson, 1999, Literature-derived bioaccumulation models for earthworms : development and validation, *Environmental Toxicology and Chemistry*, vo.18. No.9, 2110-2120.

Travis, C.C., and A.D. Arms, 1988, Bioconcentration of organics in beef, milk and vegetation, *Environ. Sci. Technol.* 22:271-274.

U.S. EPA, 1993, Wildlife Exposure Factors Handbook, Volume I of II, EPA/600/R-93/187a. Office of Research and Development, U.S. EPA Environmental Protection Agency, Washington, D.C.

U.S. EPA, 1993, Wildlife Exposure Factors Handbook, Volume II of II, EPA/600/R-93/187b. Office of Research and Development, U.S. EPA Environmental Protection Agency, Washington, D.C.

U.S. EPA, 1992, Guidelines for exposure assessment, Washington, D.C. Science Advisory Board, EPA report number EPA/630/R-92/001.



## Attachment C TOXICITY ASSESSMENT

### (1) Introduction

The purpose of the toxicity assessment is to weigh available evidence regarding the potential for a particular contaminant to cause adverse effects in exposed individuals or populations of receptors, and to provide an estimate of the relationship between the extent of exposure to a contaminant and the likelihood and/or severity of adverse effects. As stated in Task 4 of the Level III ERA guidance document, an ecologically-based reference dose (ERfD) is to be used in assessing possible hazards to ecological receptors from a potential ecological contaminant of concern (COPEC). Toxicological data characterizing adverse effects on ecologically relevant endpoints such as growth, seed germination, reproduction, and survival are to be used when deriving an ERfD. The following toxicological criteria are to be used for deriving an appropriate ERfD for each COPEC:

For State or Federally-listed threatened or endangered species the ERfD = Modified Chronic No Observed Adverse Effect Level (NOAEL<sub>mc</sub>) (mg.kg<sub>bw</sub><sup>-1</sup>.d<sup>-1</sup>) adjusted to account for interspecies uncertainty and multiplied by an appropriate intraspecies uncertainty factor.

For receptors other than threatened or endangered species or direct contact evaluations, the ERfD = NOAEL<sub>mc</sub> adjusted to account for interspecies uncertainty.

For direct contact evaluations for plant and soil invertebrates the ERfD = NOAEL<sub>mc</sub>. A twenty percent reduction in survival, growth, activity, or yield (measured as plant or invertebrate mass) is used as the threshold for significant effects and is considered as a chronic LOAEL (Suter *et al.* 1995, Efroymsen, *et al.* 1997a, Efroymsen *et al.* 1997b). It should be noted that a direct contact evaluation is based on a medium concentration and is not a dose. However, for this guidance, the concentration at which a change in 20 percent of the measured attribute is considered a LOAEL. No interspecies uncertainty adjustments are required for direct contact evaluations. Screening values presented in Level II may be the basis for an ERfD if additional information is not available.

Note that for aquatic habitats, the appropriate biological criteria is used in evaluating population level effects on aquatic organisms. See Attachment A for the specific criteria regarding the evaluation of aquatic habitats.

The terms lowest observed adverse effect level (LOAEL), no observed adverse effect level (NOAEL), and no observed effect level (NOEL) are used to designate the actual values generated from a toxicity study of the particular compound or stressor. The ERfD is defined as an estimate of daily intake of a specific compound or substance by an ecological receptor that is likely to be without an appreciable risk of deleterious effects. Often the ERfD is an extrapolated toxicity value generated from the specific dose-response toxicity study of the compound of interest that was initially reported as an acute, sub-acute, sub-chronic, or chronic, NOAEL, LOAEL, LD<sub>50</sub>, or other value.

It should be noted that if toxicological information on a chemical is not available for the specific receptor being modeled, then the toxicity information is to be extrapolated using the methods given below. In some cases the appropriate toxicity information may not be available or a valid extrapolation of the toxicological data may not be possible for a particular receptor. In these circumstances, the appropriate food-web model will not be

required as listed in Attachment A. A description and explanation is to be given in the Level III report for not completing any specific food-web models. If however a chemical is found in high concentrations and is site-related, then it may be warranted to establish a surrogate chemical that has sufficient toxicological information for use in a Level III ERA. The use of surrogate compounds should only be done following consultation with the appropriate Ohio EPA DERR risk assessors.

## (2) ERfD Derivation

The toxicological information shall be based, to the extent practicable, on studies in which the routes and duration of exposure were commensurate with the expected routes and duration of exposure for endpoint species of the receptor population considered in the risk assessment, or appropriate surrogate endpoint species for those receptors. If a chronic NOAEL or NOEL is not available for the endpoint species considered in the risk assessment, then the ERfD criterion may be derived from toxicity information gathered from various exposure periods, dosing regimes, and test species. Toxicological dose response data (*e.g.*, NOAEL, NOEL, LOAEL, etc.) based on exposure periods other than chronic, must be modified with uncertainty factors to derive a modified, chronic NOAEL (NOAEL<sub>mc</sub>).

Interspecies uncertainty must also be evaluated when developing an ERfD. Interspecies variability can be evaluated using either the preferred allometric scaling method for mammalian species, or by applying the appropriate taxon-based uncertainty factors. For State or Federally-listed threatened or endangered species an additional intraspecies uncertainty factor must also be applied to account for variability and sensitive sub-populations.

The adjustment and modification of toxicological data is a fundamental step in the risk assessment process. Human Health Risk assessments routinely use toxicity data based on various dosing regimes (*i.e.*, single or multiple dose) and study subjects of another (*i.e.*, non-human) species. U.S. EPA has described procedures for the extrapolation of such data for use in human health risk assessments (Risk Assessment Guidance for Superfund Volume 1 Human Health Evaluation Manual, 1989 (Part A)). The following methodologies are to be used for deriving an ERfD from toxicity data for use in ecological risk assessments and were derived from a collaboration of multiple information sources (Dourson and Stara 1983, Barnes and Dourson 1988, Calabrese and Gilbert 1993, Dourson 2000, Calabrese and Baldwin 1993, U.S. EPA 1993, U.S. EPA 1992, U.S. EPA 1989, Wentsel *et al.* 1996, West *et al.* 1997, Ford *et al.* 1992).

A step wise process (shown in Figure C-1 and summarized below) is used to extrapolate toxicological data based on various dosing regimes, exposure periods, taxonomic differences, and, when required, intraspecies uncertainty to develop an ERfD suitable for evaluating hazard to individuals or populations of selected receptor species. The ERfDs are developed using a two-tiered approach. The first tier requires that a NOAEL<sub>mc</sub> be developed from select toxicological data. The second tier adjusts the NOAEL<sub>mc</sub> for interspecies uncertainty and, when required, intraspecies uncertainty.

### A) Developing a NOAEL<sub>mc</sub>

Uncertainty factors are used to modify toxicity data to account for differences between the dosing regimes (*i.e.*, single, multiple, or continuous), exposure periods (*i.e.*, acute, sub-acute, sub-chronic, and chronic), and dose-response endpoints (*e.g.*, LOAEL, NOAEL, LD<sub>50</sub> etc.) of the critical studies and the conditions of the environmental exposure addressed in the ecological risk assessment. Figure C-1 lists the appropriate uncertainty factors for the various exposure periods and study endpoints. Figure C-1 also lists uncertainty factors used to adjust the NOAEL<sub>mc</sub> to account for taxonomic differences between test

animals and ecological endpoint species (see section 1(B)). It is recommended that acute NOAEL, acute LOAEL, or an LD<sub>50</sub> not be used in deriving a NOAEL<sub>mc</sub>. However, information was given in figure C-1 and below that gives the appropriate uncertainty factors for determining a NOAEL<sub>mc</sub> from data collected using these specific exposure periods and dose-response endpoints. These uncertainty factors should be used only when more appropriate toxicological data are not available. Irregular toxicity test data should also not be converted using this protocol; instead an Agency risk assessor should be contacted prior to completing the toxicity assessment of a Level III ERA. In some circumstances, it may be more appropriate to evaluate toxicity data from an appropriately selected surrogate compound rather than utilize a NOAEL or NOEL from an acute exposure study or an LD<sub>50</sub> for the specific chemical or compound of interest. If a chemical surrogate is to be selected for the derivation of an ERfD, then an Agency risk assessor should be contacted prior to submitting a Level III report or continuing an ecological risk assessment.

- (i) **Chronic-NOAEL or NOEL to NOAEL<sub>mc</sub>**  
No modifications are required (chronic-NOAEL = NOAEL<sub>mc</sub>). In the case where several NOAELs are identified either from one or more studies, the regulatory focus is normally on the highest value. However, Ohio EPA DERR recommends that NOAELs based on developmental or reproductive endpoints and studies with the greater number of test animals and therefore the greater power be considered as the preferred chronic-NOAEL values.
- (ii) **Sub-chronic NOAEL to NOAEL<sub>mc</sub>**  
Chronic toxicity data are the preferred data for use in ecological risk assessments. If only sub-chronic NOAEL studies are available in the literature, then an uncertainty factor of one-half order of magnitude based on a log scale (sub-chronic NOAEL multiplied by 1/3), or one order of magnitude (sub-chronic NOAEL multiplied by 1/10) should be used to modify the data for estimating a NOAEL<sub>mc</sub>. If the exposure period of the sub-chronic NOAEL is more consistent with a chronic exposure period of the test organism, then the one-half order of magnitude uncertainty factor should be used to estimate a NOAEL<sub>mc</sub>. If however, the exposure period is closer to a sub-acute or other short-term exposure period, then the one order of magnitude uncertainty factor should be applied to the data to estimate the NOAEL<sub>mc</sub>.
- (iii) **Chronic LOAEL or LOEL to NOAEL<sub>mc</sub>**  
U.S. EPA methodology (U.S. EPA 1997) provides a procedure for the conversion of a LOAEL to NOAEL. This methodology suggests that an uncertainty factor of up to 10 could be used to convert a LOAEL to a NOAEL. U.S. EPA (1989) recommends an uncertainty factor of up to 10 when LOAELs are converted to NOAELs for use in human health risk assessments. Critical studies citing a LOAEL may list a variety of adverse effects as the basis for the LOAEL. These effects range from gross effects, such as death, to more subtle biochemical, physiological, or pathologic changes. For this reason Ohio EPA DERR employs either a one-half or one order of magnitude (based on a log scale) uncertainty factor to extrapolate a chronic-NOAEL from a chronic-LOAEL. For ecological risk assessments conducted for sites in Ohio, an uncertainty factor of one-half order of magnitude (chronic-LOAEL multiplied by 1/3) is to be used for estimating a

NOAEL<sub>mc</sub> derived from a chronic-LOAEL or chronic-LOEL when the observed adverse effect on the test animal was minor, (e.g., subtle biochemical effects, minor physiological changes, etc.), or was based on a reproductive endpoint. An uncertainty factor of one order of magnitude is to be used to estimate a NOAEL<sub>mc</sub> from a chronic-LOAEL (chronic-LOAEL multiplied by 1/10) if the critical effect was based on gross or severe effects (e.g., substantial decrease in body or relative organ weights, an effect that would decrease survivability in a wild environment, etc.) or the number of test animals was low in the critical study and therefore, effects in a larger percent (e.g., 50%) of the exposed animals were required to see a statistical difference from the control animals.

- (iv) Sub-chronic LOAEL to NOAEL<sub>mc</sub>  
Chronic NOAEL toxicity data are the preferred data for use in ecological risk assessments. If only sub-chronic LOAEL studies are available in the literature, then an uncertainty factor of one order of magnitude (sub-chronic LOAEL multiplied by 1/10), one and one-half order of magnitude (sub-chronic LOAEL multiplied by 1/30), or two orders of magnitude (sub-chronic LOAEL multiplied by 1/100) may be used to extrapolate a NOAEL<sub>mc</sub> from a sub-chronic LOAEL value. The final uncertainty factor applied will be a combination of two factors that account for the LOAEL to NOAEL conversion (see (2)(A)(iii) above) and the sub-chronic to chronic extrapolation (see (2)(A)(ii) above). The uncertainty factor is to be derived by using the following guidelines:

#### Sub-chronic LOAEL to chronic LOAEL

If the exposure period of the sub-chronic LOAEL is more consistent with a chronic exposure period, then a one-half order of magnitude uncertainty factor is selected to adjust the sub-chronic LOAEL to a chronic LOAEL (sub-chronic LOAEL multiplied by 1/3). If the exposure period is more consistent with a sub-acute or other short-term exposure period, then a one order of magnitude uncertainty factor is appropriate to convert the sub-chronic LOAEL to a chronic LOAEL (sub-chronic LOAEL multiplied by 1/10).

#### Chronic LOAEL to NOAEL<sub>mc</sub>

The chronic LOAEL to NOAEL<sub>mc</sub> extrapolation is based on the severity and endpoint of the observed effect cited in the critical study. The uncertainty factors used are either a one-half order of magnitude (3), or a one order of magnitude (10) value. See section (2)(A)(iii) above for criteria for selecting the appropriate value for the uncertainty factor.

#### Final Sub-chronic LOAEL to NOAEL<sub>mc</sub> Uncertainty Factor

The final uncertainty factor used to extrapolate a NOAEL<sub>mc</sub> from a sub-chronic LOAEL is the product of the two previous uncertainty factors (sub-chronic to chronic and the LOAEL to NOAEL) and ranges from one order of magnitude to two orders of magnitude. Examples: a) If the sub-chronic to chronic uncertainty factor is one-half order of magnitude (3) and the chronic LOAEL to chronic NOAEL is also one-half order of magnitude (3), then the final uncertainty factor would equal one

order of magnitude ( $3 \times 3 \sim 10$  = sub-chronic LOAEL multiplied by  $1/10$  =  $\text{NOAEL}_{\text{mc}}$ ). b) If the sub-chronic to chronic uncertainty factor is one order of magnitude (10) and the chronic LOAEL to  $\text{NOAEL}_{\text{mc}}$  uncertainty factor is one-half order of magnitude (3), then the final uncertainty factor would equal one and one-half order of magnitude (sub-chronic LOAEL multiplied by  $1/30$  =  $\text{NOAEL}_{\text{mc}}$ ). c) If the sub-chronic to chronic uncertainty factor is one order of magnitude (10) and the chronic LOAEL to chronic NOAEL is also one order of magnitude (10), then the final uncertainty factor would equal two orders of magnitude ( $10 \times 10 = 100$  = sub-chronic LOAEL multiplied by  $1/100$  =  $\text{NOAEL}_{\text{mc}}$ ).

- (v) **Acute NOAEL to  $\text{NOAEL}_{\text{mc}}$**   
A  $\text{NOAEL}_{\text{mc}}$  can be estimated from an acute-NOAEL only when necessary by multiplying the acute-NOAEL by an uncertainty factor of two orders of magnitude (acute-NOAEL x  $1/100$ ).
- (vi) **Acute LOAEL to  $\text{NOAEL}_{\text{mc}}$**   
A  $\text{NOAEL}_{\text{mc}}$  can be estimated from an acute-LOAEL only when necessary by multiplying the acute-LOAEL by an uncertainty factor of three orders of magnitude (acute-LOAEL x  $1/1000$ ).
- (vii)  **$\text{LD}_{50}$  to  $\text{NOAEL}_{\text{mc}}$**   
A  $\text{NOAEL}_{\text{mc}}$  can be estimated from an acute-LOAEL only when necessary by multiplying the  $\text{LD}_{50}$  by an uncertainty factor of four orders of magnitude ( $\text{LD}_{50}$  x  $1/10,000$ ).

Acute NOAEL, Acute LOAEL, or  $\text{LD}_{50}$  data should only be used when necessary. It may be more appropriate to use a surrogate chemical when only toxicological data of this type is available.

- B) **Interspecies Uncertainty Factors (Adjusting the  $\text{NOAEL}_{\text{mc}}$ );**  
The adjustments of the  $\text{NOAEL}_{\text{mc}}$  for interspecies uncertainty and, when necessary, intraspecies uncertainty constitutes the second tier in the derivation of the ERfD. One of two alternative methodologies may be used to adjust a  $\text{NOAEL}_{\text{mc}}$  that was developed from toxicity information gathered from a test species different from the selected endpoint species. It is recommended that this adjustment step only be used if toxicity data are not available for the specific selected endpoint species evaluated in the ecological risk assessment.
- (i) **Taxonomically-based Uncertainty Factors;**  
Taxonomically-based uncertainty factors may be selected to account for differences in interspecies sensitivity. Figure C-1 and the text below both describe the appropriate uncertainty factors to be applied in a taxonomically-based adjustment of a  $\text{NOAEL}_{\text{mc}}$ . If the toxicological study test species and the selected endpoint species in the ecological risk assessment are of the:
  - a) **Same Genus**  
If the appropriate  $\text{NOAEL}_{\text{mc}}$  was derived using a test organism within the same genus as the endpoint species in the ecological risk assessment then, no uncertainty factor is required and the  $\text{NOAEL}_{\text{mc}}$  equals the ERfD.

- b) *Same Family*  
If the appropriate NOAEL<sub>mc</sub> was derived using a test species within the same family as the endpoint species in the ecological risk assessment then, an uncertainty factor of one-half order of magnitude (the NOAEL<sub>mc</sub> is multiplied by 1/3) is required to convert the NOAEL<sub>mc</sub> to the ERfD.
- c) *Same Order*  
If the appropriate NOAEL<sub>mc</sub> was derived using a test species of the same order as the endpoint species in the ecological risk assessment then, an uncertainty factor of one order of magnitude (the NOAEL<sub>mc</sub> is multiplied by 1/10) is required to convert the NOAEL<sub>mc</sub> to the ERfD. If the test species is not of the same order as the endpoint species in the ecological risk assessment then, an uncertainty factor of two orders of magnitude (the NOAEL<sub>mc</sub> is multiplied by 1/100) is required to convert the NOAEL<sub>mc</sub> to the ERfD. Taxonomically-based adjustments should not be performed between taxa in different classes (e.g., Aves, Mammalia).

- (ii) Allometric scaling;  
Allometric scaling is an alternative method to the taxonomically-based uncertainty factors that can be used to adjust a NOAEL<sub>mc</sub> in the derivation of an ERfD. NOAELs and LOAELs are daily dose levels normalized to the body weight of the test organisms (e.g., milligrams of chemical per kilogram body weight per day). With toxicity data presented on a mg.kg<sub>bw</sub><sup>-1</sup>.d<sup>-1</sup> basis, comparisons across species with consideration for body size is possible. Studies have shown that numerous physiological rates and activities are a function of body size. Smaller animals generally have greater metabolic rates than larger animals, and usually are more resistant to toxic effects because of the more rapid rates of detoxification.

However, many substances are activation-dependent and require bio-transformation to be converted into their active or toxic forms. If the compound for which the ERfD is being developed requires activation to the toxic form, or metabolites of the parent compound are produced that are also toxic, then the taxonomically-based adjustment is preferred over the allometric scaling method.

The allometric scaling method is only to be used for mammalian species. The modification of a NOAEL<sub>mc</sub> for avian receptors must be done by using the taxonomically-based interspecies uncertainty factors as given in section (1)(B)(i).

For mammals, it has been shown that this relationship is best expressed in terms of body weight (bw) raised to the 3/4 power (bw<sup>3/4</sup>) (Travis and White 1988, Travis et al. 1990, and U.S. EPA 1992). If the dose (d) has been calculated in terms of unit body weight (i.e., mg kg<sup>-1</sup>) then the metabolic dose (D) equates to:

$$D = \frac{(d \times bw)}{bw^{3/4}} = d \times bw^{1/4} \quad (1)$$

The assumption is that the dose per body surface area (eq. 1) for species "a" and "b" would be equivalent:

$$d_a \times bw_a^{1/4} = d_b = d_b \times bw_b^{1/4} \quad (2)$$

Therefore, knowing the body weights of two species and the dose ( $d_b$ ) producing a given effect in species "b," the dose ( $d_a$ ) producing the same effect in species "a" can be determined:

$$d_a = d_b \times \frac{bw_b^{1/4}}{bw_a^{1/4}} = d_b \times \frac{(bw_b)^{1/4}}{(bw_a)^{1/4}} \quad (3)$$

If however a  $NOAEL_{mc}$  is available for a mammalian test species ( $NOAEL_t$ ), the process becomes less complicated and the equivalent  $NOAEL_{mc}$  for a mammalian wildlife species ( $NOAEL_w$ ) can be calculated by using the adjustment factor for the differences in body size:

$$NOAEL_w = NOAEL_t \frac{(bw_t)^{1/4}}{(bw_w)^{1/4}} \quad (4)$$

For avians, research suggests that physiological scaling factors developed for mammals may not be appropriate for interspecies extrapolation. Mineau et al. (1996) developed body weight based scaling factors for birds using  $LC_{50}$  data for 37 pesticides. Scaling factors ranged from 0.63 to 1.55 with a mean of 1.15. However, scaling factors for the majority of the chemicals evaluated (29 of 37) were not significantly different from 1. A scaling factor of 1 was therefore considered most appropriate for interspecies extrapolation among birds. However, because the allometric scaling method for avians only considered data from toxicity studies with  $LC_{50}$  endpoints, this method is not recommended for estimating avian interspecies uncertainty for the derivation of an ERfD.

For interspecies extrapolation for mammalian species, the body weight scaling method, is recommended over the use of the uncertainty factors (section 1(B)), for converting  $NOAEL_{mc}$  from test species to those that may be used for endpoint species in ecological risk assessments unless the chemical of interest is activation-dependent. If multiple conversions are required during the derivation of the  $NOAEL_{mc}$ , then it is suggested that the dosing regime conversions be completed prior to the use of the allometric scaling. This will insure that the proportional conservatism remains and is carried through the allometric scaling.

C) Intraspecies Uncertainty Factors;

If the endpoint species is a State or Federally-listed threatened or endangered species, then an additional uncertainty factor is required to account for variation within the endpoint species population. This intraspecies uncertainty factor is intended to protect sensitive sub-populations and individuals, and account for the individual effects to such populations, in addition to population effects. Figure C-1 lists the uncertainty factors to be applied to the adjusted  $NOAEL_{mc}$  when State or Federally-listed organisms are modeled in the ecological risk assessment.

The intraspecies uncertainty factor is intended to be applied to a  $NOAEL_{mc}$  after it has been adjusted using either the taxonomically-based uncertainty factors or the allometric

approach to account for interspecies uncertainty. The intraspecies uncertainty factor is to be either one-half or one order of magnitude (adjusted NOAEL<sub>mc</sub> multiplied by 1/3 or 1/10 respectively) based upon whether the critical study effects (NOAEL or LOAEL) were closely related to effects on populations (e.g., reproductive, growth, or developmental effects) rather than more subtle effects on individuals (e.g., biochemical responses, behavioral changes). If the effects in the critical study or studies, were related to population effects, then the one order of magnitude uncertainty factor should be used to account for intraspecies uncertainty. If the effects in the critical study or studies were related to effects on individuals, then the one-half order of magnitude uncertainty factor should be used to account for intraspecies uncertainty.

**(3) General Use of Uncertainty Factors**

It is recommended that the total UFs applied to develop an ERfD not exceed 3,000 for most receptors. For special interest species, the 3,000 maximum UF may need additional scrutiny. If there is uncertainty in more than four areas of extrapolation, then it is unlikely that the database is sufficient derive an ERfD. OEPA should be contacted if the database does not support the development of an ERfD.

**(4) Toxicological Information Sources**

Toxicological information is available from the following sources:

- A) Integrated Risk Information System (IRIS)  
It should be noted that the critical studies cited in IRIS that were used to generate the reference doses will need to be reviewed to obtain the appropriate data for developing an ERfD. IRIS can be accessed via the Internet (<http://www.epa.gov/iris/index.html>);
- B) ECOTOX Database  
The [ECOTOXicology database](#) is a source for locating single chemical toxicity data for aquatic life, terrestrial plants and wildlife. ECOTOX integrates three U.S. EPA, Office of Research and Development (ORD), National Health and Environmental Effects Research Laboratory (NHEERL), Mid-Continent Ecology Division, toxicology effects databases; AQUIRE (aquatic life), PHYTOTOX (terrestrial plants), and TERRETOX (terrestrial wildlife).
- C) Agency for Toxic Substances and Disease Registry (ATSDR) Toxicity Profiles;
- D) TOXLINE (National Library of Medicine);
- E) Hazardous Substances Data Bank (National Library of Medicine); and,
- F) Registry of Toxic Effects of Chemical Substances (RTECs).



C-1, ERfD Derivation

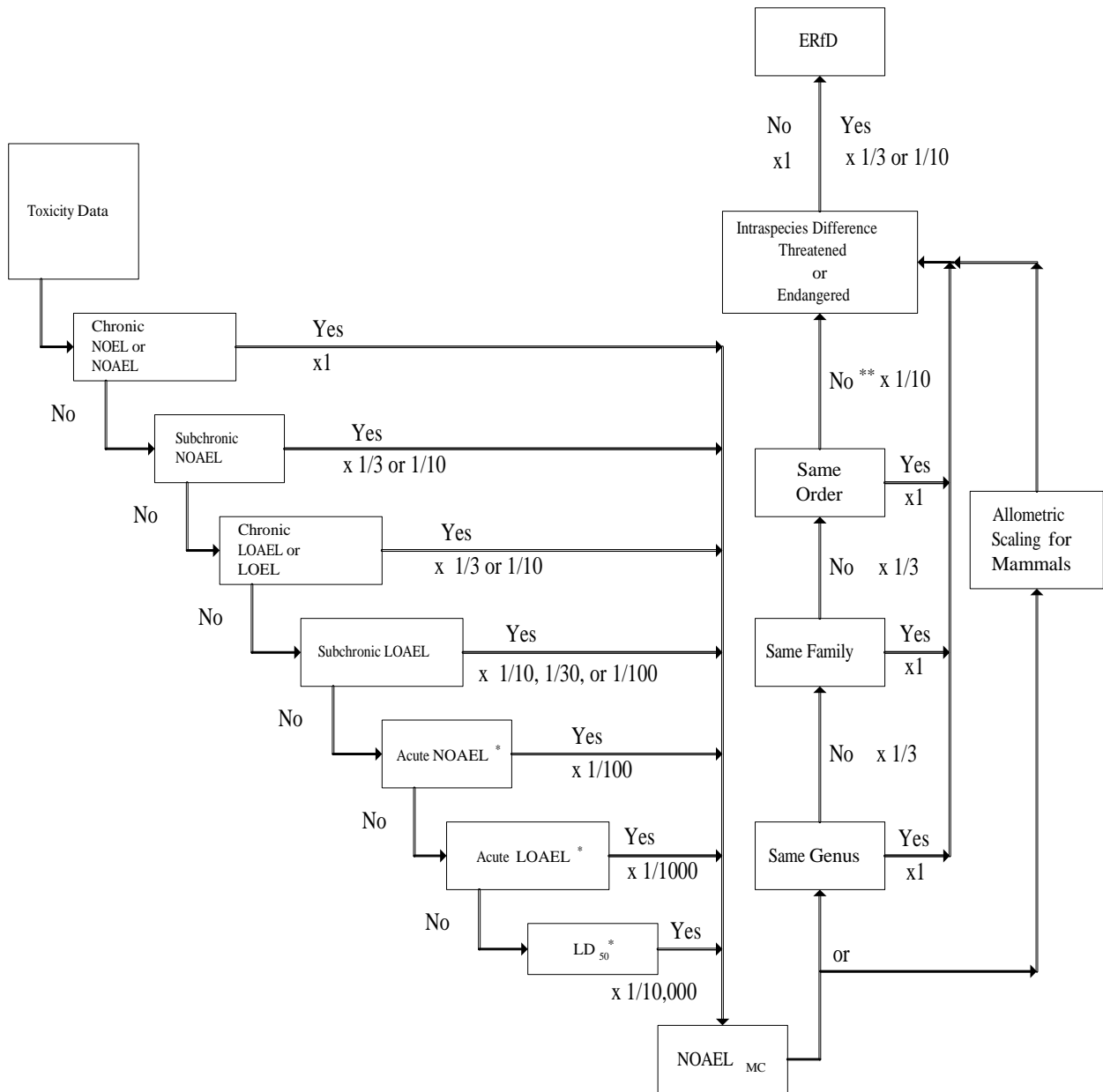

\*Acute NOAEL, Acute LOAEL, or LD<sub>50</sub> data should only be used when necessary. It may be more appropriate to use a surrogate chemical when only toxicological data of this type is available. An agency toxicologist should be contacted before surrogates are selected or used in an ecological risk assessment.

\*\* For toxicological test species and receptor species classified in the same taxonomic order, but found within the same class (e.g., Mammalia, Aves). Taxonomically-based adjustments should not be performed between taxa in different classes.

## Literature Cited

Amdur, M. O., J. Doull, C.D. Klaassen (Editors), 1991, *Casarett and Doull's, Toxicology, The Basic Science of Poisons*, Fourth Edition, Pergamon Press, USA.

Barnes, D.G., M.L. Dourson, 1988, Reference Dose (RfD): Description and Use in Health Risk Assessments, *Regul. Pharmacol.* 8:471-86.

Calabrese, E.J., and L. A. Baldwin (Editors), 1993, *Performing Ecological Risk Assessments*, Lewis Publishers, Chelsea, Mi.

Calabrese, E.J., C.E. Gilbert, 1993, Lack of Total Independence of Uncertainty Factors (Ufs) Implications for the Size of the Total Uncertainty Factor, *Regul. Pharmacol.* 17: 854-71.

Dourson, M. L, 2000, Methods for Establishing Oral Reference Doses: *Risk Assessment of Essential Elements*, editors: Mertz, Abernathy and Olin, ILSI Press, Washington DC, pp. 51-61.

Dourson, M.L., J.F. Stara, 1983, Regulatory History and Experimental Support of Uncertainty (Safety) Factors, *Regulatory Toxicology and Pharmacology*, 3, 224-238.

Duke, L.D., and M. Taggart, 2000, Uncertainty factors in screening ecological risk assessments, *Environmental Toxicology and Chemistry*, vol. 19, no. 6, pp. 1668-1680.

Efroymson R.A., M.E. Will, and G.W. Suter II, 1997a, Toxicological Benchmarks for Contaminants of Concern for Effects on Soil and Litter Invertebrates and Heterotrophic Process: 1997 Revision, ES/ER/TM-126/R2, Oak Ridge National Laboratory Environmental Sciences Division.

Efroymson, R.A., M.E. Will, G.W. Suter II, and A.C. Wooten, 1997b, Toxicological Benchmarks for Screening Contaminants of Potential Concern for Effects on Terrestrial Plants: 1997 Revision, ES/ER/TM-85/R3, Oak Ridge National Laboratory Environmental Sciences Division.

Ford, K.L., F.M. Applehans, and R. Ober, 1992, Development of Toxicity Reference Values for Terrestrial Wildlife, In: HMCL/Superfund 1992 Conference & Exhibition Proceedings, Hazardous Materials Control Resources Institute, Greenbelt, MD.

Mineau, P., B.T. Collins, and A. Baril, 1996, On the use of scaling factors to improve interspecies extrapolation of acute toxicity in birds, *Regulatory Toxicology and Pharmacology*, 24: 24-29.

Suter, G.W., II, B.E. Sample, D.S. Jones, T.L. Ashwood, and J.M. Loar, 1995, Approach and Strategy for Performing Ecological Risk Assessments for the U.S. Department of Energy's Oak Ridge Reservation: 1995 Revision. ES/ER/TM-33/R2, Oak Ridge National Laboratory, Environmental Sciences Division.

Travis, C.C., R.K. White, and R.C. Wards, 1990, Interspecies extrapolation of pharmacokinetics, *J. Theor. Biol.*, 142, 285-304.

Travis, C.C. and R.K. White, 1988, Interspecific scaling of toxicity data, *Risk Analysis*, vol. 8, No.1, 1988.

U.S. EPA, 1997, Ecological Risk Assessment Guidance for Superfund: Process for Designing and Conducting Ecological Risk Assessments, Interim Final, EPA/540/R-97/006.

U.S. EPA, 1993, Reference Dose (RfD): Description and Use in Health Risk Assessments, Background Document 1A, IRIS.

U.S. EPA, 1992, A cross-species scaling factor for carcinogenic risk assessment based on equivalence of  $\text{mg/kg}^{3/4}/\text{day}$ : draft report, Federal Register 57(109):24152-24173.

U.S. EPA, 1989, Risk Assessment Guidance for Superfund, Volume I, Human Health Evaluation Manual (Part A), Interim Final, EPA/540/1-89/002.

Wentsel, R.S., T.W. La Point, M. Simini, R.T. Checkai, D. Ludwig, and L.W. Brewer, 1996, Tri-Service Procedural Guidelines for Ecological Risk Assessments, OMB No. 0704-0188.

West, G.B., J.H. Brown, and B.J. Enquist, 1997, A general model for the origin of allometric scaling laws in biology, Science, vol. 276: 122-126.

## Attachment D RECEPTOR LIFE HISTORY DATA

### (1) Introduction

Attachment D presents life history information for specific species that are to be used in evaluating potential hazards to ecological receptors. In practice, ecological risk assessments generally evaluate and choose similar measurement endpoints for use in estimating risks to ecological receptors. These receptors are often chosen based on the availability of toxicity information, the abundance of the receptors, their role as potential food sources for predators, their limited home ranges, and their specific feeding habits. Ohio EPA DERR has selected a list of "Generic Receptors" to be used in ecological risk assessments. The ERA process recommended by Ohio EPA DERR, lists specific criteria for selecting and using representative species in an ERA. The receptor criteria are given in Attachment A of the Level III ERA guidance.

Outside data sources (most notably the Wildlife Exposures Factor Handbook from U.S. EPA) have been coalesced to simplify and standardize the life history information for use in ecological risk assessments completed for Ohio EPA DERR and are given in Table D-1. The species specific tables (section 2.0) following Table D-1 give the references for the cited information. A complete list of these references is found in section 2.

Table D-1. Generic Receptor Life History Information

Species/Feeding Habit	Body Weight (g)	Normalized Food Ingestion Rate (NIR <sub>f</sub> ) (g.g <sub>bw</sub> <sup>-1</sup> .d <sup>-1</sup> )	Normalized Water Intake Rate (g.g <sub>bw</sub> <sup>-1</sup> .d <sup>-1</sup> )	Dietary Composition (percent by weight)			Home Range (ha)
				Plant (P <sub>F</sub> )	Animal (A <sub>F</sub> )	Incidental Soil (S <sub>F</sub> )	
Plants							na
Earthworms							na
<b>Herbivore</b>							
Meadow vole	32.9	0.33	0.18	0.98	0	0.02	0.027
Deer mouse	21	0.27	0.22	0.5	0.46	0.02	0.059
Eastern cottontail	1220	0.2	0.097	0.94	0	0.063	3.1
White-tailed deer	56500	0.031	0.065	0.98	0	0.02	175
Muskrat	1174	0.3	0.98	1	0	0	0.13
Mallard duck	1162	0.063	0.057	0.98 <sup>1</sup>	0	0.03 <sup>1</sup>	435
<b>Invertivore</b>							
Short-tailed shrew	17	0.56	0.223	0.13 <sup>1</sup>	0.87 <sup>1</sup>	0.06 <sup>1</sup>	0.39
American robin	81	1.2	0.14	0.5 <sup>1</sup>	0.5 <sup>1</sup>	0.05 <sup>1</sup>	0.25
American woodcock	170	0.77	0.1	0	0.9	0.1	25
Spotted sandpiper	42.5	1.5	0.17	0	0.86	0.14	0.25
<b>Carnivore</b>							
Red-tailed hawk	1134	0.1	0.057	0	1	0	876
American kestrel	119	0.3	0.12	0	1	0	106
Red fox	4535	0.095	0.085	0.046 <sup>1</sup>	0.95 <sup>1</sup>	0.028 <sup>1</sup>	504
<b>Piscivore</b>							
Mink	1020	0.16	0.079	0	1	0	470
Mink	1020	0.16	0.079	0	1	0	2.24 <sup>2</sup>
Belted kingfisher	147	0.5	0.11	0	1	0	1.16 <sup>2</sup>
Great blue heron	2336	0.18	0.045	0	1	0	0.6 3.1 <sup>2</sup>

<sup>1</sup> Due to the data being from multiple sources the diets summations are greater than 100%.

<sup>2</sup> km of shoreline.

For citations, see tables below

## (2) Species Specific Tables

Parameter	Definition	Receptor: Meadow vole ( <i>Microtus pennsylvanicus</i> )	
		Value	Reference / Notes
BW	Body weight (g)	32.9	Arithmetic mean of means, adult, both sexes, all seasons (EPA 1993)
NIR <sub>f</sub>	Normalized Food ingestion rate (g.g <sub>bw</sub> <sup>-1</sup> .d <sup>-1</sup> )	0.33	EPA 1993
P <sub>F</sub>	Plant fraction of diet	0.98	Arithmetic mean of all seasons, assumed to be vegetative parts (EPA 1993), diet is assumed to be the vegetative portion of the plants
A <sub>F</sub>	Animal fraction of diet	0	Assumed to be negligible
S <sub>F</sub>	Soil fraction of diet	0.02	Beyer, Conner, and Gerould 1994
NIR <sub>w</sub>	Normalized Water ingestion rate (g.g <sub>bw</sub> <sup>-1</sup> .d <sup>-1</sup> )	0.18	Arithmetic mean of means, adult, both sexes, (EPA 1993)
HR	Home range (ha)	0.027	Arithmetic mean of means, adult both sexes (EPA 1993)
TUF	Temporal use factor	1	Assumed to be present year-round.

Parameter	Definition	Receptor: Deer mouse ( <i>Peromyscus maniculatus</i> )	
		Value	Reference / Notes
BW	Body weight (g)	21	Arithmetic mean of means, adult, both sexes (EPA 1993)
NIR <sub>f</sub>	Normalized Food ingestion rate (g.g <sub>bw</sub> <sup>-1</sup> .d <sup>-1</sup> )	0.27	Arithmetic mean of means (EPA 1993)
P <sub>F</sub>	Plant fraction of diet	0.5	Based on data from Wolff et al. 1985, Whitaker 1966, and Batzli 1977, diet is considered to be the reproductive portions of the plants
A <sub>F</sub>	Animal fraction of diet	0.46	Arthropods, based on data from Wolff et al. 1985, Whitaker 1966, and Batzli 1977
S <sub>F</sub>	Soil fraction of diet	0.02	Beyer, Conner, and Gerould 1994
NIR <sub>w</sub>	Normalized Water ingestion rate (g.g <sub>bw</sub> <sup>-1</sup> .d <sup>-1</sup> )	0.22	Non-reproductive females, based on data from Oswald et al., 1994
HR	Home range (ha)	0.059	Mean of males and females, mixed deciduous forest, Wolff 1985
TUF	Temporal use factor	1	Assumed to be present year-round.

Parameter	Definition	Receptor: Eastern cottontail ( <i>Sylvilagus floridanus</i> )	
		Value	Reference / Notes
BW	Body weight (g)	1220	Arithmetic mean of means, adult, both sexes, all seasons (EPA 1993)
NIR <sub>f</sub>	Normalized Food ingestion rate (g.g <sub>bw</sub> <sup>-1</sup> .d <sup>-1</sup> )	0.2	Dalke and Sime 1941
P <sub>F</sub>	Plant fraction of diet	0.94	Exclusively herbivorous, assumed to be vegetative parts (EPA 1993)
A <sub>F</sub>	Animal fraction of diet	0	Not stated in EPA (1993); assumed to be negligible
S <sub>F</sub>	Soil fraction of diet	0.063	Assumed comparable to that for black-tailed jackrabbit (6.3%) (Arthur and Gates 1988)
NIR <sub>w</sub>	Normalized Water ingestion rate (g.g <sub>bw</sub> <sup>-1</sup> .d <sup>-1</sup> )	0.097	EPA 1993
HR	Home range (ha)	3.1	EPA 1993
TUF	Temporal use factor	1	Assumed to be present year-round

Parameter	Definition	Receptor: White-tailed deer ( <i>Odocoileus virginianus</i> )	
		Value	Reference / Notes
BW	Body weight (g)	56500	Sample and Suter (1994)
NIR <sub>f</sub>	Normalized Food ingestion rate (g.g <sub>bw</sub> <sup>-1</sup> .d <sup>-1</sup> )	0.031	1.74 kg d <sup>-1</sup> (Sample and Suter 1994) converted to g g <sub>bw</sub> <sup>-1</sup> d <sup>-1</sup> by dividing by body weight of 56500 g
P <sub>F</sub>	Plant fraction of diet	0.98	Exclusively herbivorous, assumed to be vegetative parts (Sample and Suter 1994)
A <sub>F</sub>	Animal fraction of diet	0	Assumed to be negligible
S <sub>F</sub>	Soil fraction of diet	0.02	Sample and Suter 1994
NIR <sub>w</sub>	Normalized Water ingestion rate (g.g <sub>bw</sub> <sup>-1</sup> .d <sup>-1</sup> )	0.065	3.7 L d <sup>-1</sup> (Sample and Suter 1994) converted to g g <sub>bw</sub> <sup>-1</sup> d <sup>-1</sup> by dividing by body weight of 56500 g
HR	Home range (ha)	175	Geometric mean of minimum (59) and maximum (520) reported in Sample and Suter 1994
TUF	Temporal use factor	1	Assumed to be present year-round

Parameter	Definition	Receptor: Muskrat ( <i>Ondatra zibethicus</i> )	
		Value	Reference / Notes
BW	Body weight (g)	1174	Arithmetic mean of means, adult, both sexes, all seasons (EPA 1993)
NIR <sub>f</sub>	Normalized Food ingestion rate (g.g <sub>bw</sub> <sup>-1</sup> .d <sup>-1</sup> )	0.3	Arithmetic mean of means (EPA 1993)
P <sub>F</sub>	Plant fraction of diet	1	Exclusively herbivorous, assumed to be vegetative parts (EPA 1993)
A <sub>F</sub>	Animal fraction of diet	0	Assumed to be negligible
S <sub>F</sub>	Soil fraction of diet	0	Assumed to be negligible
NIR <sub>w</sub>	Normalized Water ingestion rate (g.g <sub>bw</sub> <sup>-1</sup> .d <sup>-1</sup> )	0.98	Estimated (EPA 1993)
HR	Home range (ha)	0.13	Arithmetic mean of means (EPA 1993)
TUF	Temporal use factor	1	Assumed to be present year-round

Parameter	Definition	Receptor: Mallard duck ( <i>Anas platyrhynchos</i> )	
		Value	Reference / Notes
BW	Body weight (g)	1162	Arithmetic mean of means, adult, both sexes, all seasons (EPA 1993)
NIR <sub>f</sub>	Normalized Food ingestion rate (g.g <sub>bw</sub> <sup>-1</sup> .d <sup>-1</sup> )	0.063	Estimated based on $F=0.648(bw)^{0.651}$ , ingestion rate for birds, Opresko et al. (1994)
P <sub>F</sub>	Plant fraction of diet	0.98	Assumed to be a 50% mixture of vegetation and fruit/seed
A <sub>F</sub>	Animal fraction of diet	0	Assumed to be negligible
S <sub>F</sub>	Soil fraction of diet	0.03	Beyer et al. 1994
NIR <sub>w</sub>	Normalized Water ingestion rate (g.g <sub>bw</sub> <sup>-1</sup> .d <sup>-1</sup> )	0.057	Estimated (EPA 1993)
HR	Home range (ha)	435	Arithmetic mean of means, adult, both sexes, spring (EPA 1993)
TUF	Temporal use factor	1	Assumed to be present year-round however site specific or other information may be used to estimate a site-specific TUF



Parameter	Definition	Receptor: <b>Short-tailed shrew</b> ( <i>Blarina brevicauda</i> )	
		Value	Reference / Notes
BW	Body weight (g)	17	Arithmetic mean of means, adult, both sexes, summer and fall (EPA 1993)
NIR <sub>f</sub>	Normalized Food ingestion rate (g.g <sub>bw</sub> <sup>-1</sup> .d <sup>-1</sup> )	0.56	Arithmetic mean of adults, both sexes, 25 <sup>o</sup> C, Wisconsin (EPA 1993)
P <sub>F</sub>	Plant fraction of diet	0.13	June through October, New York (EPA 1993); assuming vegetative parts and fungi
A <sub>F</sub>	Animal fraction of diet	0.87	June through October, New York (EPA 1993); assuming 100% earthworms
S <sub>F</sub>	Soil fraction of diet	0.06	EPA 1999
NIR <sub>w</sub>	Normalized Water ingestion rate (g.g <sub>bw</sub> <sup>-1</sup> .d <sup>-1</sup> )	0.223	Adult, both sexes, Illinois, lab (EPA 1993)
HR	Home range (ha)	0.39	EPA 1993
TUF	Temporal use factor	1	Assumed to be present year-round

Parameter	Definition	Receptor: <b>American robin</b> ( <i>Turdus migratorius</i> )	
		Value	Reference / Notes
BW	Body weight (g)	81	Arithmetic mean of means, adult, both sexes, summer and fall (EPA 1993)
NIR <sub>f</sub>	Normalized Food ingestion rate (g.g <sub>bw</sub> <sup>-1</sup> .d <sup>-1</sup> )	1.2	Arithmetic mean of adults, both sexes, (EPA 1993)
P <sub>F</sub>	Plant fraction of diet	0.5	Arithmetic mean, 4 seasons, central U.S., % of stomach contents that is animal material (EPA 1993); assumed to be plant fruit/seed
A <sub>F</sub>	Animal fraction of diet	0.5	Arithmetic mean, 4 seasons, central U.S., % of stomach contents that is animal material (EPA 1993); assumed to be earthworm
S <sub>F</sub>	Soil fraction of diet	0.05	Based on value for American woodcock ( <i>Solopax minor</i> )(Beyer, Conner, and Gerould 1994) and adjusted for the proportion of earthworm in the robin diet
NIR <sub>w</sub>	Normalized Water ingestion rate (g.g <sub>bw</sub> <sup>-1</sup> .d <sup>-1</sup> )	0.14	Estimated, both sexes, adult (EPA 1993)
HR	Home range (ha)	0.25	Arithmetic mean of adults, both sexes, (EPA 1993)
UF	Temporal use factor	1 0.58	Assumed to be present year-round however site specific or other information may be used to estimate a site-specific TUF, Migrate from northern breeding range in mid-October, return to northern breeding range in early-March (EPA 1993)

Parameter	Definition	Receptor: American woodcock ( <i>Scolopax minor</i> )	
		Value	Reference / Notes
BW	Body weight (g)	170	Arithmetic mean of means, adult, both sexes, spring, summer and fall (EPA 1993)
NIR <sub>f</sub>	Normalized Food ingestion rate ( $\text{g} \cdot \text{g}_{\text{bw}}^{-1} \cdot \text{d}^{-1}$ )	0.77	Mean, winter, captive study (EPA 1993)
P <sub>F</sub>	Plant fraction of diet	0	Assumed to be negligible
A <sub>F</sub>	Animal fraction of diet	0.9	EPA 1993
S <sub>F</sub>	Soil fraction of diet	0.1	Beyer et al. 1994
NIR <sub>w</sub>	Normalized Water ingestion rate ( $\text{g} \cdot \text{g}_{\text{bw}}^{-1} \cdot \text{d}^{-1}$ )	0.1	Estimated (EPA 1993)
HR	Home range (ha)	25	Arithmetic mean of means, adult, spring, and summer (EPA 1993)
TUF	Temporal use factor	1 0.58	Assumed to be present year-round however, site specific or other information may be used to estimate a site-specific TUF. Migrate from northern breeding range in November, return to northern breeding range in late March (Sheldon 1971)

Parameter	Definition	Receptor: Spotted sandpiper ( <i>Actitis macularia</i> )	
		Value	Reference / Notes
BW	Body weight (g)	42.5	Arithmetic mean of means, adult, both sexes (EPA 1993)
NIR <sub>f</sub>	Normalized Food ingestion rate ( $\text{g} \cdot \text{g}_{\text{bw}}^{-1} \cdot \text{d}^{-1}$ )	1.5	Estimated using equation 3-3 (EPA 1993)
P <sub>F</sub>	Plant fraction of diet	0	Not stated in EPA (1993); assumed to be negligible
A <sub>F</sub>	Animal fraction of diet	0.86	Aquatic invertebrates (EPA 1993)
S <sub>F</sub>	Soil fraction of diet	0.14	EPA (1993)
NIR <sub>w</sub>	Normalized Water ingestion rate ( $\text{g} \cdot \text{g}_{\text{bw}}^{-1} \cdot \text{d}^{-1}$ )	0.17	Arithmetic mean of means, adult, both sexes (EPA 1993)
HR	Home range (ha)	0.25	(EPA 1993)
TUF	Temporal use factor	1	Assumed to be present year-round however, site specific or other information may be used to estimate a site-specific TUF

Parameter	Definition	Receptor: <b>Red-tailed hawk</b> ( <i>Buteo jamaicensis</i> )	
		Value	Reference / Notes
BW	Body weight (g)	1134	Arithmetic mean of means, adult, both sexes (EPA 1993)
NIR <sub>f</sub>	Normalized Food ingestion rate (g.g <sub>bw</sub> <sup>-1</sup> .d <sup>-1</sup> )	0.1	Arithmetic mean of means, adult, both sexes, captive, outdoors (EPA 1993)
P <sub>F</sub>	Plant fraction of diet	0	Not stated in EPA (1993); assumed to be negligible
A <sub>F</sub>	Animal fraction of diet	1	Prey brought to nests (EPA 1993)
S <sub>F</sub>	Soil fraction of diet	0	Not stated in EPA (1993) and Beyer et al. (1994); assumed to be negligible
NIR <sub>w</sub>	Normalized Water ingestion rate (g.g <sub>bw</sub> <sup>-1</sup> .d <sup>-1</sup> )	0.057	Estimated (EPA 1993)
HR	Home range (ha)	876	Mean, adults, both sexes (EPA 1993)
TUF	Temporal use factor	1	Assumed to be present year-round however, site specific or other information may be used to estimate a site-specific TUF

Parameter	Definition	Receptor: <b>American kestrel</b> ( <i>Falco sparverius</i> )	
		Value	Reference / Notes
BW	Body weight (g)	119	Arithmetic mean of means, adult, both sexes (EPA 1993)
NIR <sub>f</sub>	Normalized Food ingestion rate (g.g <sub>bw</sub> <sup>-1</sup> .d <sup>-1</sup> )	0.3	Arithmetic mean of means adult, both sexes (EPA 1993)
P <sub>F</sub>	Plant fraction of diet	0	Assumed to be negligible
A <sub>F</sub>	Animal fraction of diet	1	EPA 1993
S <sub>F</sub>	Soil fraction of diet	0	Assumed to be negligible
NIR <sub>w</sub>	Normalized Water ingestion rate (g.g <sub>bw</sub> <sup>-1</sup> .d <sup>-1</sup> )	0.12	Estimated, both sexes, adult (EPA 1993)
HR	Home range (ha)	106	Arithmetic mean of means, adult, both sexes (EPA 1993)
TUF	Temporal use factor	1	Assumed to be present year-round however, site specific or other information may be used to estimate a site-specific TUF

Parameter	Definition	Receptor: <b>Red fox</b> ( <i>Vulpes vulpes</i> )	
		Value	Reference / Notes
BW	Body weight (g)	4535	Arithmetic mean of means, adult, both sexes (EPA 1993)
NIR <sub>f</sub>	Normalized Food ingestion rate ( $\text{g} \cdot \text{g}_{\text{bw}}^{-1} \cdot \text{d}^{-1}$ )	0.095	Adult non-breeding, North Dakota (EPA 1993)
P <sub>F</sub>	Plant fraction of diet	0.046	Illinois farm/woods, spring, percent wet weight (EPA 1993); assumed to be reproductive parts
A <sub>F</sub>	Animal fraction of diet	0.95	Illinois farm/woods, spring, percent wet weight (EPA 1993); assumed to be reproductive parts
S <sub>F</sub>	Soil fraction of diet	0.028	Estimated percent soil in diet, dry weight (EPA 1993)
NIR <sub>w</sub>	Normalized Water ingestion rate ( $\text{g} \cdot \text{g}_{\text{bw}}^{-1} \cdot \text{d}^{-1}$ )	0.085	Arithmetic mean, adult, both sexes (EPA 1993)
HR	Home range (ha)	504	Arithmetic mean, adult, both sexes, Minnesota and Wisconsin (EPA 1993)
TUF	Temporal use factor	1	Assumed to be present year-round however, site specific or other information may be used to estimate a site-specific TUF

Parameter	Definition	Receptor: <b>Great blue heron</b> ( <i>Ardea herodias</i> )	
		Value	Reference / Notes
BW	Body weight (g)	2336	Arithmetic mean of means, adult, both sexes (EPA 1993)
NIR <sub>f</sub>	Normalized Food ingestion rate ( $\text{g} \cdot \text{g}_{\text{bw}}^{-1} \cdot \text{d}^{-1}$ )	0.18	Mean, adult, both sexes (EPA 1993)
P <sub>F</sub>	Plant fraction of diet	0	Assumed to be negligible
A <sub>F</sub>	Animal fraction of diet	1	Assumed to be fish, may also include site specific prey items (EPA 1993)
S <sub>F</sub>	Soil fraction of diet	0	Assumed to be negligible
NIR <sub>w</sub>	Normalized Water ingestion rate ( $\text{g} \cdot \text{g}_{\text{bw}}^{-1} \cdot \text{d}^{-1}$ )	0.045	Estimated (EPA 1993)
HR	Home range (ha)	0.6 3.1(km)	Size of feeding area only (EPA 1993) or, forage area (length of shoreline, km)
TUF	Temporal use factor	1	Assumed to be present year-round however, site specific or other information may be used to estimate a site-specific TUF

Parameter	Definition	Receptor: Mink ( <i>Mustela vison</i> )	
		Value	Reference / Notes
BW	Body weight (g)	1020	Arithmetic mean of means, adult, both sexes, Montana (EPA 1993)
NIR <sub>f</sub>	Normalized Food ingestion rate ( $\text{g} \cdot \text{g}_{\text{bw}}^{-1} \cdot \text{d}^{-1}$ )	0.16	Arithmetic mean of means, adult, both sexes (EPA 1993)
P <sub>F</sub>	Plant fraction of diet	0	Assumed to be negligible
A <sub>F</sub>	Animal fraction of diet	1	Assumed to be fish, may also include site specific prey items (EPA 1993)
S <sub>F</sub>	Soil fraction of diet	0	Assumed to be negligible
NIR <sub>w</sub>	Normalized Water ingestion rate ( $\text{g} \cdot \text{g}_{\text{bw}}^{-1} \cdot \text{d}^{-1}$ )	0.079	Arithmetic mean of means, adult, both sexes (EPA 1993)
HR	Home range (ha)	470	Arithmetic mean of means, adult, both sexes (EPA 1993)
HR	Home range (km)	2.24	km of stream, mean of means, adult, both sexes (EPA 1993)
TUF	Temporal use factor	1	Assumed to be present year-round however, site specific or other information may be used to estimate a site-specific TUF

Parameter	Definition	Receptor: Belted kingfisher ( <i>Ceryle alcyon</i> )	
		Value	Reference / Notes
BW	Body weight (g)	147	Arithmetic mean of means, adult, both sexes (EPA 1993)
NIR <sub>f</sub>	Normalized Food ingestion rate ( $\text{g} \cdot \text{g}_{\text{bw}}^{-1} \cdot \text{d}^{-1}$ )	0.5	Mean, adult, both sexes Michigan (EPA 1993)
P <sub>F</sub>	Plant fraction of diet	0	Assumed to be negligible
A <sub>F</sub>	Animal fraction of diet	1	Assumed to be fish, may also include site specific prey items (EPA 1993)
S <sub>F</sub>	Soil fraction of diet	0	Assumed to be negligible
NIR <sub>w</sub>	Normalized Water ingestion rate ( $\text{g} \cdot \text{g}_{\text{bw}}^{-1} \cdot \text{d}^{-1}$ )	0.11	Estimated (EPA 1993)
HR	Home range (km shoreline)	1.16	Arithmetic mean of means, adult, both sexes (EPA 1993)
TUF	Temporal use factor	1	Assumed to be present year-round however, site specific or other information may be used to estimate a site-specific TUF

## Literature Cited

Arthur, W.J., III and R.J. Gates, 1988, Trace elements intake via soil ingestion in pronghorn and in black-tailed jackrabbits, *J. Range Manage.*, 41: 162-166.

Batzli, G.O., 1977, Population dynamics of the white-footed mouse in flood plain and upland forests, *Am. Midl. Nat.* 97: 18-32.

Beyer, M.N. et. al. Survey of Soil Ingestion by Wildlife. Prepared for the U.S. Environmental Protection Agency, Office of Policy, Planning and Evaluation. Washington D.C.

Beyer, W., E.E. Connor, and S. Gerould, 1994, Estimates of soil ingested by wildlife, *Journal of Wildlife Management* 58(2):375-382.

Dallke, P.D., and P.R. Sime, 1941, Food habits of the eastern and New England cottontails, *J. Wildl. Manage.*, 5: 216-228.

EPA 1993, Wildlife Exposure Factors Handbook Volume I of II, U.S. EPA/600/R-93/187a.

EPA 1999, Region V Ecological Screening Levels for RCRA Appendix IX Hazardous Constituents, Working Draft.

Opresko, D.M., B.E. Sample, and G.W. Suter, III, 1994, Toxicological benchmarks for wildlife, ES/ER/TM-6/R1, Oak Ridge National Laboratory.

Oswald, C., P. Fonken, D. Atkinson, and M. Palladino, 1993, Lactational water balance and recycling in white-footed mice, red-backed voles, and gerbils, *J. Mammal.* 74: 963-970.

Sample, B.E. and G.W. Suter II, 1994, Estimating exposure of terrestrial wildlife to contaminants, ES/ER/TM-125, Oak Ridge National Laboratory.

Sheldon, J.A., 1971, *The Book of the American Woodcock*, University of Massachusetts Press.

Whitaker, J.O., Jr. 1966, Food of *Mus musculus*, *Peromyscus maniculatus bairdii* and *Peromyscus leucopus* in Vigo County, Indiana, *J. Mammal.* 47: 473-486.

Wolff, J.O., R.D. Dueser, and K.S. Berry, 1985, Food habits of sympatric *Peromyscus leucopus* and *Peromyscus leucopus*, *J. Mammal.* 66: 795-798.

Wolff, J.O., 1985, The effects of density, food, and interspecific interference on home range size in *Peromyscus leucopus* and *Peromyscus maniculatus*, *Can. J. Zool.* 63: 2657-2662.

## **Attachment E**

### **Level III Report - Outline**

- (1) Introduction**

  - (a) Site History
  - (b) Regulatory Status
  - (c) Summary of previous ecological evaluations (e.g., summaries of the Level I and II reports)
  
- (2) Results**

The information in the results section should be adequate to reproduce pertinent calculations.

  - (a) Exposure assessment
  - (b) Toxicity assessment
  - (c) Risk characterization
  - (d) Uncertainty analysis
  
- (3) Recommendation**

The recommendations section should discuss the results of all ecological evaluations that have been conducted at the site. The focus of the discussion should be on the results of the Level III ERA. The information if being used in an RI/FS or similar enforcement case, should not imply decision making as it is the role of OEPA in these cases. The recommendation discussion should provide the results without dictating or suggesting a final risk management or remedial decision for the site. Generally, three options are possible at this stage of the ecological evaluation: 1) No further action at the site due to no adverse ecological effects being estimated or identified as the result of the completion of the Level III and previous ERAs; 2) Continued ecological evaluation in a Level IV-Field baseline ecological risk assessment; or, 3) Risk management/remedy selection. If the risk management/remedy selection decision is being suggested, then medium specific remediation goals based on the receptors and COPECs found to be problematic should be developed and resented in the Level III report for use in remedy selection as part of the feasibility study (FS) for the site. If the assessment is being conducted for another process or program (e.g., Voluntary Action Program (VAP)) the report should follow or comply with the appropriate requirements. Please contact the specific OEPA programs for additional specifics for the Level III report.
  
- (4) Attachments**

Attachments should include tables that list toxicity values and references, in-put parameters for all up-take calculations, chemical concentrations in all media that were evaluated in the Level III ERA, and any other information needed to reproduce the risk calculations.

## CHAPTER 5

# LEVEL IV - FIELD BASELINE

### 5.1 OBJECTIVE

The objective of a Level IV field baseline assessment is to quantify, based on field observation, adverse effects to populations of representative species that have been shown to be potentially impacted based upon the hazard calculation(s) developed in a Level III ecological risk assessment (ERA). The information derived by use of a Level IV assessment is to be used as additional lines of evidence to support a more robust weight-of-evidence conclusion regarding the potential adverse effects identified and quantified in the Level III risk assessment.

### 5.2 PREREQUISITES

The completion of a Level III ERA and a decision to continue the ecological evaluation using biological and other field-based measurements are the prerequisites for beginning a level IV ERA. Prior to proceeding with a Level IV ERA, it must be cautioned that designing an acceptable field study to determine whether or not impacts are observed in field conditions is often difficult. The Level IV risk assessment differs from the previous ecological investigations in the amount of over-sight that is required for a field-baseline risk assessment. Approval of the sampling and analysis plan is required by the Ohio EPA DERR prior to any field work.

The following is a list of tasks required for the completion of a Level IV field baseline ecological risk assessment:

### 5.3 TASK

The following tasks are to be completed as part of a Level IV ERA:

#### 5.3.1 Task 1 Refine Problem Formulation

Following the assessment process described in the Level III guidance, there should now be a limited number of contaminants of ecological concern (COECs) under consideration.

Once again, the relationship between specific COECs, their toxicological characteristics, their likely pathway to specific ecological receptors, and the effect(s) they may induce in these receptors should be re-examined. This re-examination should substantially lessen the chance of engaging in field and/or laboratory investigations that do not provide information useful to risk managers.

The Problem Formulation should consist of:

#### A) Select COECs

The results of the Level III ERA will have identified COECs on the basis of risk characterization. Because the Level IV evaluation is focused on population studies and/or laboratory studies that use contaminated media taken from the actual site, the COECs will be assessed as a mixture in any given evaluation. The Level III ERA will have identified the ecological stressors most likely to be adversely impacting biological communities. These COECs should be discussed as the primary risk drivers in the Level IV ERA.

#### B) Review/Revise Established Measures

For a Level IV ERA, measures are expected to be numerical expressions of observations (e.g., toxicity results, community diversity measures, tissue analysis, etc.) that are to be compared to reference locations or other controls to detect adverse responses in endpoint species resulting from exposure to site-related COECs. The first output of this comparison is the determination of whether adverse responses are occurring at site-related COEC concentrations. For sites where adverse responses are identified, the second output may be the identification of the concentration level(s) where site-related COEC's may be causing the adverse responses. The use of a concentration gradient is recommended to make determinations of the range of adverse effects and to aid in the selection of final remedial levels.



When defining measures for field and laboratory investigations, select those with as strong of an association as possible between site-related COECs and responses in the selected measures and those that represent the same exposure pathway and toxic mechanism of action as the assessment endpoint with which they are associated. Development of empirical exposure-response relationships is important for evaluating remedial options, so selection of measures that incorporate a COEC concentration gradient should be a goal whenever possible.

### 5.3.2 **Task 2 Select Assessment Tools**

Presently, there are a limited number of assessment tools for conducting site-specific field evaluations on adverse ecological effects induced by ecological stressors. The chosen methods will depend on site-specific factors and the risk hypotheses and measures chosen for the assessment. The basic categories of field-based ecological measures that should be evaluated for use in a Level IV field-baseline assessment are given below:

#### A) Tissue Analysis/Bioaccumulation Studies

Contaminant concentrations in tissues may have been quantified and used during the Level III ERA. It is important to mention that generally, hazard quotient calculations will not be repeated in the Level IV ERA. As discussed in Level III, HQ calculations are to be conducted one time only, using realistic and site-specific information, that may include empirically derived contaminant tissue concentrations for use in the exposure assessment. It has been demonstrated that reiterations of hazard calculations are not particularly useful. For example, if an initial hazard calculation exceeds the limit of unity by more than two orders of magnitude, then, rarely will additional recalculations result in hazard quotient values being reduced to below unity. Information gained through tissue analysis conducted following the Level III ERA, may be used for the development of site-specific remedial goals and will help determine the bioavailability of a COEC.

Tissue analysis that may be useful in determining whether field impacts can be demonstrated in the field include:

- (i) Chemical analysis of tissues (specific organs, tissues, whole body);
- (ii) Laboratory bioaccumulation studies (uptake measured in a laboratory setting using contaminated media from the site);
- (iii) Field measured bioaccumulation studies (receptor, animal or surrogate, placed on-site in proximity to contaminated media);
- (iv) Gross morphology and/or histopathology;
- (v) Biomarkers;
- (vi) Results obtained with one or more of the above may be used to support the following analysis (to be used primarily for remedial goals determination and not for generating additional hazard quotient values):

#### B) Population/Community Evaluations/Toxicity Tests

The populations to be evaluated or the appropriate toxicity test should be chosen based upon the results of the Level III ERA and discussions with the appropriate Ohio EPA DERR personnel. The most relevant population studies or *in situ* toxicity studies should be chosen. Generally, the lowest trophic levels that have been identified with elevated hazard quotient values are to be investigated during a field baseline ERA. These include soil microbial studies, soil invertebrate assays, plant community analysis and, occasionally, small mammal investigations.

The following methods are useful for measuring and quantifying adverse ecological effects and responses to contaminants:

- (i) Community metrics (measurements of species composition, abundance community structure, trophic dynamics, seasonal patterns, age classes, etc.);
- (ii) Population metrics (measurements of density patterns, growth, and survival, etc.) –study site vs. reference area differences related to the presence of COECs;

- (iii) Physiological and behavioral measurements respiration, photosynthesis, reproduction, predation, courtship, etc.; and,
  - (iv) Field experiments.
- C) Toxicity Tests (Bioassay)  
Toxicity tests are useful for measuring and quantifying both exposure and ecological responses to contaminants. These tests may be conducted in the laboratory, field, and *in situ*. They are appropriate measures for both lethal and /or sub-lethal responses and may be use to:
- (i) Demonstrate and/or quantify the bioavailability of COECs;
  - (ii) Evaluate the aggregate toxic effects of all contaminates in a medium;
  - (iii) Evaluate the toxicity of substances whose biological effects may have not been well characterized.
  - (iv) Compare toxicity data generated at the site with that obtained in the laboratory or literature;
  - (v) Characterize the nature of a toxic effect
  - (vi) Characterize the distribution of toxicity at a site;
  - (vii) Support a monitoring program;
  - (viii) Develop remedial goals; and,
  - (ix) Determine the post-remediation potential of the site to support viable communities.

### **5.3.3 Task 3 Prepare Field Ecological Sampling and Analysis Plan**

The Level V field ecological sampling and analysis plan (FESAP) describes details of the site-specific field and/or laboratory investigations(s). It addresses the field and/or laboratory collection and analysis of ecological data. The data collection and analysis must be consistent with, and achievable within, the scope of the analysis plan prepared for the Level IV ERA, as well as the overall remedial investigation work plan. The FESAP may also include the methods for determining site-specific remedial concentrations. Because field and/or laboratory investigations can be expensive, time-consuming, and result in ambiguous results, it is important to consider the types of studies that will provide the most expeditious and defensible (*i.e.*, supported by scientific literature, peer review, and statistical evaluations) test of the stated risk hypotheses. The plan may include, but not limited to:

- A) A description of the study design, including its key assumptions and uncertainties. The design is guided by the conceptual site model and results of the Level III ERA. The study design should also take into account any new information that has been obtained regarding the site, receptors, or COECs.
- B) A statement of data needs. These data needs are to be specific for testing the risk hypotheses (Is there, or, is there no appreciable harm to the selected ecological receptors?) and, if harm is demonstrated, to assist in the selection of a remedy. Basically, the discussion should focus on how each piece of data planned for collection will be used to answer the question of whether or not adverse impacts to pertinent ecological receptors or populations exists or can be quantified. The discussion may also include how site-specific remedial clean-up values will be generated if needed.
- C) A detailed description of the assessment tools (see task (2) above) that will yield data of the type and quality required for the Level IV ERA.
- D) A statement of data quality objectives (DQOs) for all key components of the field and/or laboratory investigations, considering that DQOs should be used in conjunction with, not as a substitute for, a scientifically defensible experimental design.

The FESAP must be approved prior to initiating field and/or laboratory investigations. The approval of the FESAP will be given by the appropriate Ohio EPA personnel that is overseeing the site. If some time has elapsed since site surveys/visits were conducted, an additional site visit may be required to verify that the study design specified in the FESAP is still possible to implement, (*i.e.*, whether sampling and testing specified by the FESAP can actually be collected at the site). It may be necessary to modify the FESAP in response to changes in site conditions before approval to proceed with field or laboratory investigations.

### **5.3.4 Task 4 Conduct Field/Laboratory Work**

The site investigation involves implementation of the agreed upon FESAP and includes all of the field sampling and surveys that are conducted as part of the Level IV ERA.

### **5.3.5 Task 5 Perform Risk Characterization**

Risk characterization is designed to evaluate the likelihood of an adverse effect in an endpoint species (associated with an assessment endpoint) from exposure to a site-related COECs. The risk characterization discusses the results and interpretation of the Level IV field evaluations. The risk characterization is also to be used to develop a comprehensive evaluation of the hazards being expressed at the site as the result of site-related COECs. This discussion should use information from the Level IV effort and the information obtained in the previous risk assessment efforts and is used to develop a weight-of-evidence approach to discuss the risk characterization. The lines of evidence that may be available in Level IV to construct a weight-of-evidence risk characterization include, but are not limited to:

- A) Observations of adverse effects in potentially exposed habitats compared to reference sites, including mortality and morbidity, vegetation stress, habitat degradation, and, presence or absence of key species;
- B) Presence of endangered species or sensitive habitat;
- C) COEC concentrations in surface water, soil, sediment, or tissues that exceed doses observed or estimated to cause chronic toxicity. This information is the part of the results of the Level III ERA including the appropriate HQ and HI values;
- D) Detection of acute or chronic toxicity in surface waters, soil or sediment;

- E) Tissue and/or bioaccumulation analysis provide evidence of COEC availability in animals and plants;
- F) Biomarkers which suggest that receptors have been exposed to COECs;
- G) Observed changes in rates of physiological and/or behavioral processes (e.g., respiration, photosynthesis, burrowing, or predation); and,
- H) Observations from ecological field studies of communities or populations.

### **5.3.6 Task 6 Perform Uncertainty Analysis**

Uncertainty analysis involves summarizing assumptions made in the Level IV assessment, evaluating their validity and sensitivity, identifying the strengths and weaknesses of the analyses (laboratory and field), and quantifying, to the extent possible, the uncertainty associated with each component of the Level IV assessment.

### **5.3.7 Task 7 Submit Level IV Deliverable**

This deliverable is a document which will describe how the various field measurements were conducted, the results of all laboratory analyses, the assumptions employed by these analyses, the result of the weight-of-evidence discussions, and a thorough evaluation of the uncertainties inherent in the Level IV risk assessment. The results presented in the Level IV report will provide a factual basis for the determination of whether a remedial activity is required. The results may also be used to quantify the remedial goals based on site-specific parameters, receptors, and conditions.

## Attachment A Useful References

### General References:

Listed below are references that discuss or provide guidance on several topics that could be incorporated into a Level IV ERA. These references are not complete.

- 1) U.S. EPA. 1997. *Superfund Program Representative Sampling Guidance, Volume 3: Biological-DRAFT*. Office of Solid Waste and Emergency Response, U.S. Environmental Protection Agency, Washington DC. In US EPA. 1997. *Ecological Risk Assessment Guidance for Superfund: Process for Designing and Conducting Ecological Risk Assessments*. EPA/540/R-97/006. Office of Solid Waste and Emergency Response, U.S. Environmental Protection Agency, Washington DC.  
This reference includes information regarding, standard field studies for ecological assessment (population/community response studies, toxicity tests), collection methods and quality assurance/quality control.
- 2) U.S. EPA. 1994. *Catalogue of Standard Toxicity Tests for Ecological Risk Assessment*. EPA/540/F-94/013. ECO Update, Office of Solid Waste and Emergency Response, U.S. Environmental Protection Agency, Washington DC.  
This reference includes information regarding aquatic, sediment, terrestrial and microbial toxicity test methods.
- 3) U.S. EPA. 1994. *Field Studies for Ecological Risk Assessment*. EPA/540/F-94/014. ECO Update, Office of Solid Waste and Emergency Response, U.S. Environmental Protection Agency, Washington DC.  
This reference includes information regarding, organism selection for field studies, ecological field study design and field study sampling and collection methods.
- 4) U.S. EPA. 1992. *Evaluation of Terrestrial Indicators for Use in Ecological Assessment at Hazardous Waste Sites*. EPA/600/R92/183. Office of Research and Development, U.S. Environmental Protection Agency, Washington DC.  
This reference includes information regarding animal test methods for the assessment of soil contamination at hazardous waste sites, plant test methods for the assessment of soil contamination at hazardous waste sites, soil biota test methods for the assessment of soil contamination at hazardous waste sites and field methods for the assessment of soil contamination at hazardous waste sites.
- 5) U.S. EPA. 1991. *Compendium of ERT Toxicity Testing Procedures*. EPA/540/P-91/009. Office of Solid Waste and Emergency Response, U.S. Environmental Protection Agency, Washington D.C.  
This reference includes information regarding standard operating procedures for the ecological sampling methods of genera *Pimephales*, *Daphnia*, *Ceriodaphnia*, and *Selenastrum*.
- 6) U.S. EPA. 1989. *Ecological Assessment of Hazardous Waste Sites: A Field and Laboratory Reference*. EPA/600/3-89/013. Office of Research and Development, U.S. Environmental Protection Agency, Washington DC.  
This reference includes information regarding field assessment methods for vegetation, terrestrial invertebrate and terrestrial vertebrates, aquatic, terrestrial and microbial toxicity tests, biomarkers and sampling design.
- 7) Chapman, P.M., 1995, Extrapolating toxicity results to the field, *Environ. Toxicol. Chem.* 14:927-930.

**Vegetation Measurement References:**

- 1) ASTM (American Society of Testing and Materials), 1998, E-1598-94 Standard practice for conducting early seedling growth tests, 1998 Annual Book of ASTM Standards, Volume 11.05, ASTM, West Conshohocken, PA, pp. 994-1000.
- 2) Daubenmire, R.F., 1959, Canopy coverage method of vegetation analysis, *Northwest Scientist*, 33:43-64.
- 3) Diersing, V.E., R.B. Shaw, and D.J. Tazik, 1992, US Army Land Condition-Trend Analysis (LCTA) program, *Environ. Mgmt.* 16:405-414.
- 4) EPA, 1986, SW-846 Test Methods for Evaluating Solid Wastes Third Edition, U.S. Environmental Protection Agency, OSWER, Washington, DC.
- 5) Giovanetti, M. and B. Mosse, 1980, An evaluation technique for measuring vesicular-arbuscular mycorrhizal infection in roots, *New Phytol.* 84:489-500.
- 6) Hair, J.D., 1980, Measurement of Ecological Diversity, In: S.D. Schemnitz (Ed.), *Wildlife Management Techniques Manual*, 4<sup>th</sup> edition, The Wildlife Society, Washington, DC. pp. 269-276.
- 7) Kapustka, L.A., 1989, Vegetation Assessment, In: W. Warren-Hicks, B.R. Parkhurst, and S.S. Baker, Jr. (Eds.), *Ecological Assessment of Hazardous Waste Sites: A Field and Laboratory Reference*, EPA/600/3-89/013. U.S. Environmental Protection Agency, Environmental Research Laboratory, Corvallis, OR.

**Microbiological Measurement References:**

- 1) Parmelle, R.W., R.S. Wentsel, C.T. Phillips, M. Simini, and R.T. Checkai, 1993, Soil microcosm for testing the effects of chemical pollutants on soil fauna communities and trophic structure, *Environ Toxicol Chem* 12:1477-1486.
- 2) Giller, K.E., E. Witter, and S.P. McGrath, 1998, Toxicity of heavy metals to microorganisms and microbial processes in agricultural soils: a review, *Soil Biol. Biochem* 30:1389-1414.
- 3) Domsch, K.H. G.A. Jagnow, and T.H. Anderson, 1983, An ecological concept for assessment side-effects of agrochemicals on soil microorganisms, *Residue Rev.* 86:65-105.
- 4) Sunahara, G.I., S. Dodard, S. Sarrazin, M. Paquet, G. Ampleman, S. Thiboutot, J. Hawari, and A.Y. Renoux, 1998, Development of a soil extraction procedure for ecotoxicity characterization of energetic compounds, *Ecotoxicol. Environ. Saf.* 39:185-194.
- 5) Babich, H, and G. Stotzky, 1980, Environmental factors that influence the toxicity of heavy metals and gaseous pollutants to microorganisms, *CRC Critical Rev Microbiol* 8:99-145.
- 6) Van Beelen, P. and P. Doelman, 1997, Significance and application of microbiological toxicity tests in assessing ecotoxicological risks of contaminants in soil and sediment, *Chemosphere*, vol. 34 no. 3 455-499.

**Soil Invertebrate Measurement References:**

- 1) US EPA. 1992. *Guide to Site and Soil Description for Hazardous Waste Site Characterization, Volume 1: Metals*. EPA/600/4-91/029. Office of Research and Development, U.S. Environmental Protection Agency, Washington D.C.

This reference includes information regarding characterization of metal contamination by soil mesofauna and macrofauna density and characterization of metal contamination by soil microbiota density.

- 2) Southwood, T.R.E., 1978, *Ecological Methods: With Particular Reference to the Study of Insect Populations*, Second Edition, John Wiley and Sons, New York, NY.  
A reference in the ECO Update for field studies, this book provides detailed capture methods and statistical analyses for invertebrate sampling.
- 3) Bromenshenk, J.J., 1989, Terrestrial Invertebrate Sampling, *In* W. Warren-Hicks, B.R. Parkhurst, and S.S. Baker, Jr. (Eds.), *Ecological Assessment of Hazardous Waste Sites: A Field and Laboratory Reference*, EPA/600/3-89/013. U.S. Environmental Protection Agency, Environmental Research Laboratory, Corvallis, OR.
- 4) Schauff, M.E. (ed.) "Collecting and preserving insects and mites: Techniques and tools." Systematic Entomology Laboratory, U.S. Department of Agriculture, Washington DC.
- 5) Luff M.L., 1975, Some features influencing the efficiency of pitfall traps, *Oecologia*. **19**: 345-357.
- 6) Greenslade, P.J.M., 1964, Pitfall trapping as a method for studying populations of Carabidae (Coleoptera), *Journal of Animal Ecology*. **33**: 301-310.
- 7) Handbook of Soil Invertebrate Toxicity Test, eds., H. Lokke and C.A.M. Van Gestel, 1998, John Wiley and Sons.
- 8) Edwards, C.A., and J. Bohlen, 1992, The effects of toxic chemicals on earthworms, *Reviews of Environmental Contamination and Toxicology*. Vol.125,pp. 23-99.
- 9) Beyer, W.N., R.L. Chaney, and B.M. Mulhern, 1982, Heavy metal concentrations in earthworms from soil amended with sewage sludge, *Journal of Environmental Quality* 11:381-385.

**Small Mammal Measurement References:**

- 1) Day, G.I., S.D. Schemnitz, and R.D. Taber, 1980, Capturing and Marking Wild Animals, *In*: S.D. Schemnitz (Ed.), *Wildlife Management Techniques Manual*, 4<sup>th</sup> edition, The Wildlife Society, Washington, D.C. pp. 61-88.
- 2) Davis, D.E. and R.L. Winstead, 1980, Estimating the Numbers of Wildlife Populations, *In*: S.D. Schemnitz (Ed.), *Wildlife Management Techniques Manual*, 4<sup>th</sup> edition, The Wildlife Society, Washington, D.C. pp. 221-246.
- 3) Drowning, R.L. 1980, Vital Statistics of Animal Population, *In*: S.D. Schemnitz (Ed.), *Wildlife Management Techniques Manual*, 4<sup>th</sup> edition, The Wildlife Society, Washington, D.C. pp. 247-268.

**Sediment and Wetland soil Bioassay/Measurement References:**

In general, no population measurements of lotic aquatic environments should be taken in a Level IV ERA. Lotic environments will have already been assessed using population measurements as described by the biological criteria in Level II and III. Population evaluations of other aquatic environments are possible. However, standard measurements for these environments are not presently available. Therefore, methods designed for lotic environments must be adapted for use in lentic and wetland environments as well as wetland evaluation techniques that are under development. Any evaluation of wetlands is to be done in coordination with Ohio EPA personnel. Below is a list of references that may be useful in evaluating wetlands and other aquatic environments (note: that many of the documents referenced below can be found at the Ohio EPA, Division of Surface Water webpage: <http://www.epa.ohio.gov/dsw/bioassess/BioCriteriaProtAqLife.aspx>):

- 1) Biological Criteria for the Protection of Aquatic Life: Volume I: The Role of Biological Data in Water Quality Assessment, 24 July 1987 (updated 15 February 1988), Ohio Environmental Protection Agency.
- 2) Biological Criteria for the Protection of Aquatic Life: Volume II: Users Manual for Biological Field Assessment of Ohio Surface Waters, 30 October 1987 (Updated 1 January 1988), Ohio Environmental Protection Agency.
- 3) Addendum to: Biological Criteria for the Protection of Aquatic Life: Volume II: Users Manual for Biological Field Assessment of Ohio Surface Waters, 30 October 1987 (Updated 1 January 1988), Ohio Environmental Protection Agency.
- 4) Biological Criteria for the Protection of Aquatic Life: Volume III: Standardized Biological Field Sampling and Laboratory Methods for Assessing Fish and Macroinvertebrate Communities, First Update September 30, 1989, Ohio Environmental Protection Agency.
- 5) The Quality Habitat Evaluation Index [QHEI]: Rationale, Methods, and Application, 6 November 1989, Ohio Environmental Protection Agency.
- 6) Yoder, C.O. and E.T Rankin, 1995, Biological criteria program development and implementation in Ohio, pp. 109-144 (Chapter 9), in W.S. Davis and T. Simon (eds), *Biological Assessment and Criteria: Tools for Water Resource Planning and Decision Making*, Lewis Publishers, Boca Raton, FL.
- 7) Rankin, E.T., Habitat indices in water resource quality assessments, pp. 181-208 (Chapter 13), in W.S. Davis and T. Simon (eds), *Biological Assessment and Criteria: Tools for Water Resource Planning and Decision Making*, Lewis Publishers, Boca Raton, FL.
- 8) DeShon, J.E., 1995, Development and application of the Invertebrate Community Index (ICI), pp. 217-243 (Chapter 15), in W.S. Davis and T. Simon (eds), *Biological Assessment and Criteria: Tools for Water Resource Planning and Decision Making*, Lewis Publishers, Boca Raton, FL.
- 9) Yoder, C.O. and E.T Rankin, 1995, Biological response signatures and the area of degradation value: new tools for interpreting multimetric data, pp. 263-286, (Chapter 17), in W.S. Davis and T. Simon (eds), *Biological Assessment and Criteria: Tools for Water Resource Planning and Decision Making*, Lewis Publishers, Boca Raton, FL.
- 10) Yoder, C.O., 1995, Policy issues and management applications of biological criteria, pp. 327-343 (Chapter 21), in W.S. Davis and T. Simon (eds), *Biological Assessment and Criteria: Tools for Water Resource Planning and Decision Making*, Lewis Publishers, Boca Raton, FL.

- 11) The Role of Biological Criteria in Water Quality Monitoring, Assessment, and Regulation, Ohio EPA Technical Report Series, 23 February 1995, Division of Surface Water, Ohio Environmental Protection Agency.
- 12) Rankin, E.T. and C.O. Yoder, The nature and sampling variability in the Index of Biotic Integrity (IBI) in Ohio streams, Division of Surface Water, Ohio Environmental Protection Agency.
- 13) Yoder, C.O., 1989, The development and use of biological criteria for Ohio surface waters, Water Quality Standards for the 21<sup>st</sup> Century, 139-145.
- 14) Yoder, C.O., 1989, Answering some concerns about biological criteria based on experiences in Ohio, Water Quality Standards for the 21<sup>st</sup> Century, 95-104.
- 15) Yoder, C.O., The integrated biosurvey as a tool for evaluation of aquatic life use attainment and impairment in Ohio surface waters, Division of Surface Water, Ohio Environmental Protection Agency.
- 16) Yoder, C.O. and E.T. Rankin, 1996, Assessing the condition and status of aquatic life designated uses in urban and suburban watersheds, pp. 201-227, in Roesneer, L.A., (ed), *Effects of Watershed Development and Management in Aquatic Ecosystems*, American Society of Civil Engineers, New York.
- 17) Boyle, T.P., G.M Smillie, J.C. Anderson and D.R. Beeson, 1990, A sensitivity analysis of nine diversity and seven similarity indices, Research Journal WPCF, vol. 62, number 6, 749-762.
- 18) Ohio EPA *Hyaella azteca* Solid Phase Sediment Toxicity Testing Procedure, Division of Environmental Services, May 1998.
- 19) Standard Operating Procedures for *Lumbriculus variegatus* 4-day Sediment Toxicity Screening Test, Bioassay Section, Division of Environmental Services, Ohio EPA.
- 20) Methods for Measuring the Toxicity and Bioaccumulation of Sediment-associated Contaminants with Freshwater Invertebrates, U.S. EPA, EPA/600/H-94/024, Office of Research and Development, Washington D.C. 20460.
- 21) Brinson, M.M., and R. Rheinhardt, 1996, The role of reference wetlands in functional assessment and mitigation, Ecological Applications, 6(1) 69-76.
- 22) Ohio Rapid Assessment Method (ORAM) for Wetlands, version 5.0, User's Manual and Scoring Forms. 2001. Ohio EPA Technical Report Wet/2001-1. Division of Surface Water. <http://www.epa.ohio.gov/dsw/wetlands/WetlandEcologySection.aspx#ORAM>

### Statistical Considerations and References:

#### General Statistical Information:

The purpose of the statistics used in a Level IV ERA is to determine whether COECs are negatively impacting populations of organisms. This is done by use of toxicity bioassays, comparing field measurements in reference areas to those in contaminated areas and identifying statistically significant differences, or other methods. A statistical test is the mathematical evaluation of the probability that a hypothesis is false. It is not the intent of this guidance to reproduce and/or reiterate the statistical work cited in the references below. It is the intent of this guidance to specify some general parameters and methodologies to ensure that biological measurements be taken in such a way to be scientifically defensible and be of such quality that meaningful risk management decisions can be made using the



results of a Level IV evaluation. The following information should be used in discussions between the Ohio EPA and other stakeholders of the site under evaluation for developing a Level IV ERA:

1) Hypothesis Formulation:

Generally, the hypothesis should be written so that  $H_0$  = Site attribute is not greater than reference area, or alternatively stated: the Site attribute is not different than the reference area. By stating the hypothesis in this format, a Type I error would indicate that the site area is impacted or adversely effected by the COECs when in fact no effects are occurring.

2) Alpha Level:

Alpha level ( $\alpha$ ) is the probability that the test would indicate that the populations were different (impacted) when in reality they were not different (not impacted). This is equal to the Type I error rate. This value should be specified in the field sampling plan and approved before field measurements are taken. This will help in the estimation of the number of required samples to achieve the appropriate power level in the statistical analysis of the Level IV population measurements. The alpha level can vary, however, levels from 5% to 20 % are recommended. It should be noted that by increasing the alpha level, the number of required samples is reduced. However, the likely-hood or chance of calling a clean site dirty (Type I error) increases as the alpha level increases.

3) Power:

The power of the test is the probability that a difference between the reference populations and the on-site populations would be detected by the test if in reality there was a difference. Power is equal to  $1-b$  where  $b$  is the type II error rate. It is recommended that power levels should be as high as possible. Generally, a power level of 95% is suggested, however study design and cost limitations may require this value to be reduced to as low as 80%.

4) Significant Difference:

The significant difference is the difference of a characteristic between two populations that would be considered important. The significant difference is usually expressed as a percent relative to the mean of the characteristic being measured. Historically, field measurements and laboratory bioassays use a significant difference range of 10 -20% as being of importance. This value may be as high as 50%, however discussions between Ohio EPA and the stakeholders is required to finalize the statistical requirements.

5) Coefficient of Variation (CV):

The coefficient of variation (CV) is the standard deviation divided by the average expressed as a percent. This value is dependent on the variability of what is being measured. It cannot be predetermined. Biological measurements can have a CV that ranges from 10% to well over 100%. Because this value must be determined before the required number of samples can be estimated for a given set of statistical parameters, it is recommended that a limited sampling event be planned on the measurement of interest before the FESAP is submitted to Ohio EPA DERR for review and approval. This limited sampling should also be discussed with Ohio EPA DERR before it is executed to minimize misunderstandings and to maximize the use and effectiveness of the results.

References:

- 1) Gilbert, R.O. and J.C. Simpson, 1992, Statistical Methods for the Attainment of Cleanup Standards. Volume 3: Reference-based Standards for Soils and Solid Media. Prepared for the U.S. Environmental Protection Agency by Pacific Northwest Laboratory. Richland Washington. December 1992. PNL-7409-vol.3-Rev.1.
- 2) Green, R.H., 1997, Sampling Design and Statistical Methods for Environmental Biologists, published by Wiley-Interscience Publication, John Wiley & Sons, New York, Chichester, Brisbane, Toronto.

- 3) Gilbert R.O., Statistical Methods for Environmental Pollution Monitoring, 1987, published by Van Nostrand Reinhold/Thomson Publishing company.
- 4) Osenberg, C.W., R.J. Schmitt, S.J. Holbrook, K.E. Abu-Saba, and A. R. Flegal, 1994, Detection of environmental impacts: natural variability, effects size, and power analysis, Ecological Applications, 4(1) 16-30.
- 5) Pitard, Francis F. , Pierre Gy's Sampling Theory and Sampling Practice, CRC Press 1993.

## CHAPTER 6

# DEFINITIONS

**“Acute Exposure”** means one dose or multiple doses of short duration spanning less than or equal to 24 hours. Often, acute lethality tests are defined as the number of test animals that die in a 14-day period following a single dose exposure. Exposure durations may vary depending on the selected test organism.

**“Adverse Effect”** means a biochemical change, functional impairment, or pathologic lesion that affects the performance of the whole organism, or reduces an organism’s ability to respond to an additional environmental challenge.

**“Average Daily Dose (ADD)”** means a dose rate averaged over a pathway-specific period of exposure expressed as a daily dose on a per-unit-body-weight basis. The ADD is usually expressed in terms of  $\text{mg kg}^{-1} \text{day}^{-1}$  or other mass-time units.

**“Areas surrounding the property”** means all areas located within one half-mile of the property boundaries.

**“Benchmark Dose (BMD) or Concentration (BMC)”** means a statistical lower confidence limit on the dose that produces a predetermined change in the response rate of an adverse effect (called the benchmark response or BMR) compared to background.

**“Benchmark Response (BMR)”** means an adverse effect, used to define a benchmark dose from which an RfD (or RfC) can be developed. The change in response rate over the background of the BMR is usually in the range of 5-10 %, which is the limit of responses typically observed in well-conducted animal studies.

**“Biota”** means the animal or plant life of a particular region.

**“Contaminant of Interest (COI)”** means any chemical suspected to be present due to past use, storage, or disposal practices that may have occurred at a site.

**“Chronic Exposure”** means multiple exposures occurring over an extended period of time, or a significant fraction of the animal's life span (approximately 10% of the lifetime of a test organism). Exposure durations may vary depending on the selected test organism. Chronic exposures are associated with multiple administrations of the compound under investigation.

**“Critical Effect”** means the first adverse effect, or its known precursor, that occurs to the most sensitive species or life stage as the dose rate of an agent increases.

**“Critical Study”** means the study that contributes most significantly to the qualitative and quantitative assessment of risk. Also termed “Principal Study”. Often, the critical study will be the one study that matches the route of expected exposure of the ecological receptor, has the greatest statistical power (largest number of test subjects per dosing concentration), identifies a toxic response (NOAEL, LOAEL), and the toxic response is not of trivial significance to the receptor.

**“dbh”** means diameter of a tree trunk measured at breast height.

**“Dose-Response Assessment”** means a determination of the relationship between the magnitude of an administered, applied, or internal dose and a specific biological response. Response can be expressed as measured or observed incidence, percent response in groups of subjects (or populations), or as the probability of occurrence within a population.

**“Ecological stressor”** means any physical, chemical (including hazardous substances and petroleum) or biological entity that can induce an adverse response to an ecological receptor.

**“Ecologically-based Reference Dose (ERfD)”** means an estimate (with uncertainty spanning perhaps an order of magnitude) of a daily oral exposure to the ecological receptor that is likely to be without an appreciable risk of deleterious effects during a lifetime. It can be derived from a NOAEL, LOAEL, or benchmark dose, with uncertainty factors generally applied to reflect limitations of the data used.

“Hazardous substance” includes all of the following:

- (a) Any substance identified or listed in rules adopted under division (B)(1)(c) of section 3750.02 of the Revised Code;
- (b) Any product registered as a pesticide under section 921.02 of the Revised Code when the product is used in a manner inconsistent with its required labeling;
- (c) Any product formerly registered as a pesticide under that section for which the registration was suspended or canceled under section 921.05 of the Revised Code;
- (d) Any mixture of a substance described in paragraphs (A)(20)(a) to (A)(20)(c) of this Rule with radioactive material; and,
- (e) Any pollution as defined under division (A) of section 6111.01 of the Revised Code.

**“Important Ecological Resource”** means any specific ecological community, population or individual organism protected by federal, state or local laws and regulations, or ecological resources that provide important natural or economic resource functions and values. Important ecological resources include, but are not limited to: any surface water, as that term is used in Chapter 3745-1 of the Administrative Code; any wetland regulated under federal law and state of Ohio's water quality laws; any dedicated natural area or preserve; any federally-listed or state-listed threatened or endangered species and its associated habitat; any state of Ohio special interest or declining species and its associated habitat; any state or national park; any federally designated wilderness area; any national lakeshore recreational area; any national preserve; any national or state wildlife refuge; any federal, state, local or private land designated for the protection of natural ecosystems; any federally-designated or state-designated scenic or wild river; any federal or state land designated for wildlife or game management; and wildlife populations and their associated important nesting areas and food resources, taking into consideration land use and the quality and extent of habitat on and in the vicinity of the site.

The definition of important ecological resource is, however, meant to exclude terrestrial areas such as mowed or maintained green spaces (e.g., manicured lawns), industrial, or other areas that do not exhibit, or exhibit only minimal natural functions. In addition, because they are not members of natural communities, any of the following should not be considered “ecologically important”: any pest and opportunistic species that populates an area because of artificial or anthropogenic conditions; any domestic or once domesticated animal (e.g., pets, livestock, or feral animals); any plant or animal whose existence is maintained by continuous human intervention (e.g., agricultural crops).

Industrialized properties may have limited green space around buildings, roadways, parking lots, etc. and there may be a limited number of trees with nests but this type of situation generally would not be considered to be providing important nesting areas and food resources to wildlife populations. However, there may be situations where industrialized sites contain limited habitat, but are capable of supporting populations or individuals of important receptors and therefore would require an ecological evaluation. For example, a small area (<0.5 acre) may be considered an important ecological resource if important

functions are provided by the area (e.g., a vernal pool that provides breeding habitat for a state declining species of amphibian).

Thus, the determination as to whether a particular site contains or could potentially impact an important ecological resource, requires an evaluation of habitat on and in the locality of the site. Habitat evaluation is the critical decision criterion for determining whether an important ecological resource is or is potentially associated with the site and therefore triggers the requirement for an ecological risk assessment.

**“Locality of the site”** means any point where an important ecological resource contacts, or is reasonably likely to come into contact with, site-related ecological stressors, considering:

- (a) The chemical and physical characteristics of the hazardous substance;
- (b) Physical, meteorological, and hydro geological characteristics that govern the tendency for hazardous substances to migrate through environmental media or to move and accumulate through food webs;
- (c) Any activity or biological process that governs the tendency for hazardous substances to move into and through environmental media or to move and accumulate through food webs; and,
- (d) The time required for contaminant migration to occur based on factors described in subsections (a) through (c).

**“Lowest-Observed-Adverse-Effect Level (LOAEL)”** means the lowest exposure level at which there are statistically or biologically significant increases in frequency or severity of adverse effects between the exposed population and its appropriate control group. Also referred to as lowest-effect level (LEL).

**“Lowest-Observed Effect Level (LOEL or LEL)”** means in a study, the lowest dose or exposure level at which a statistically or biologically significant effect is observed in the exposed population compared with an appropriate unexposed control group.

**“Non-significant Departure”** means the lower range of biological index scores that are considered acceptable for determining the attainment status of a water body using a biological measurement. Data variability is an important consideration in any assessment of environmental risks to ecosystems stemming from a number of anthropogenic influences, e.g., introduction of xenobiotics, alterations of habitats, the introduction of species, or most often a combination of these activities. This is as true for biosurvey data as for chemical or toxicological data. There are five important sources of variability in biosurvey data: 1) temporal variability (e.g., seasonal, daily, and diurnal changes in community composition); 2) sampling variability (e.g., related to gear, training, and effort); 3) spatial variability (e.g., related to stream size or faunal changes); 4) analytical variability (e.g., related to choice of the appropriate analytical tools); and 5) anthropogenic variability (e.g., degradation of water quality or habitat and/or toxic impacts to aquatic communities) (Rankin and Yoder 1990; DeShon 1995). The objective is to distinguish impacts and variability from anthropogenic sources and minimize or partition temporal, sampling, spatial, and analytical variation.

Ohio EPA uses standardized sampling methods ( for two organism groups: fish and macroinvertebrates), specified index periods (seasonal sampling), and standardized analytical tools (Ohio EPA 1987b and 1989) to minimize the sources of variation not under scrutiny (i.e., changes in community structure induced by human activities). Ohio EPA addresses the variability inherent in the biological data gathered in three general ways (Yoder and Rankin 1995):

- 1) Variability is **compressed** through the use of multimetric evaluation mechanisms such as the IBI and ICI.
- 2) Variability is **stratified** by the tiered use classification system, ecoregions, biological index calibration, and site type.
- 3) Variability is **controlled** through standardized sampling procedures that address seasonality, effort, replication, gear selectivity, and spatial concerns.

Ohio EPA used these sampling methods and analytical tools to develop numerical biological criteria (Invertebrate Community Index, ICI; Index of Biological Integrity, IBI; and the modified Index of Well-Being,  $MI_{wb}$ ) (Ohio EPA 1987a, Yoder and Rankin 1995, and DeShon 1995) for evaluating the biological integrity of a stream segment measured against the ecoregional biological criteria. Biological data have always played a central role in the Ohio water quality standards, particularly for the determination of appropriate and attainable aquatic life use designations. Aquatic life use designations are assigned to individual water body segments based on the potential to support that use according to the narrative and numeric criteria (Yoder and Rankin 1995).

Data generated by sampling stream segments, within the parameters prescribed by Ohio EPA (1989), provides an indication of the stream segment's use attainment status as measured by the ICI, IBI, and  $MI_{wb}$ . Each biological index score is compared to the ecoregional biocriterion to determine if the segment achieves that criterion. For each biological index a range of data variability attributable to sources other than anthropogenic impacts was determined and is discussed at length in other sources (DeShon 1995; Yoder and Rankin 1995; Rankin and Yoder 1990; Karr and Chu 1999). Biological index scores which fall within these ranges are considered nonsignificant departures from the criterion. If all applicable indices meet or fall in the nonsignificant departure range than a stream segment is determined to fully attain its use designation. A use designation is considered partially attained if one or two biological indices indicate attainment but others do not, as long as no index falls below a fair narrative evaluation. A use is not attained if all biological indices fail to meet the biocriteria, or if either organism group (fish or macroinvertebrate) reflects poor or very poor performance.

#### Literature Cited

- DeShon, J. E. 1995. Development and application of the invertebrate community index (ICI). Pages 217-244 in W. S. Davis and T. P. Simon, eds. *Biological Assessment and Criteria: Tools for Water Resource Planning and Decision Making*. Lewis, Boca Raton, FL.
- Karr, J. R., and E. W. Chu. 1999. *Restoring Life in Running Waters: Better Biological Monitoring*. Island Press, Washington, D.C.
- Ohio EPA. 1987a. *Biological Criteria for the Protection of Aquatic Life. Volume I: The Role of Biological Data in Water Quality Assessment*. Ohio EPA, Division of Water Quality Monitoring and Assessment, Surface Water Section, Columbus, Ohio.
- Ohio EPA. 1987b. *Biological Criteria for the Protection of Aquatic Life. Volume II: The Users Manual for Biological Field Assessment of Ohio Surface Waters*. Ohio EPA, Division of Water Quality Monitoring and Assessment, Surface Water Section, Columbus, Ohio.
- Ohio EPA. 1989a. *Biological Criteria for the Protection of Aquatic Life. Volume III: Standardized Biological Field Sampling and Laboratory Methods for Assessing Fish and Macroinvertebrate Communities*. Ohio EPA, Division of Water Quality Planning and Assessment, Ecological Assessment Section, Columbus, Ohio.
- Ohio EPA. 1989b. *Addendum to Biological Criteria for the Protection of Aquatic Life. Volume II: The Users Manual for Biological Field Assessment of Ohio Surface Waters*. Ohio EPA, Division of Water Quality Planning and Assessment, Ecological Assessment Section, Columbus, Ohio.
- Rankin, E. T. and C. O. Yoder. 1990. The nature of sampling variability in the Index of Biotic Integrity in Ohio streams. Pages 9-18 in W. S. Davis (editor). *Proceedings of the 1990 Midwest Pollution Control Biologists Meeting*. EPA 905-9-90-005. U. S. Environmental Protection Agency, Region 5, Environmental Sciences Division, Chicago, Illinois.
- Yoder, C.O. and E. T. Rankin. 1995. Biological criteria program development and implementation in Ohio. Pages 109-144 in W. S. Davis and T. P. Simon, eds. *Biological Assessment and Criteria: Tools for Water Resource Planning and Decision Making*. Lewis, Boca Raton, FL.

**“No-Observed-Adverse-Effect Level (NOAEL)”** means the highest exposure level at which there are no statistically or biologically significant increases in the frequency or severity of adverse effect between the exposed population and its appropriate control; some effects may be produced at this level, but they are not considered adverse, nor precursors to adverse effects.

**“No-Observed-Effect Level (NOEL)”** means an exposure level at which there are no statistically or biologically significant increases in the frequency or severity of any effect between the exposed population and its appropriate control.

**“One-half Order of Magnitude”** means the one-half order of magnitude uncertainty factor of three is based on a logarithmic scale and is discussed in: Regulatory History and Experimental Support of Uncertainty (Safety) Factors, Michael L. Dourson and Jerry F. Starta, Regulatory Toxicology and Pharmacology 3: 224-238, 1983. This paper was cited by U.S. EPA as the bases for the uncertainty factors used in the derivation of RfD values in IRIS. Mathematically the half order of magnitude using the logarithmic scale can be explained as follows:

$$10^0 = 1$$
$$10^1 = 10$$

Therefore: one half the value or distance on a log scale would be represented by:  $10^{0.5} = 3.162$ , which equals 3 when rounded to one significant digit.

**“Ruderal”** means compacted, plowed, paved, or otherwise disturbed ground usually related to industrial or commercial activities.

**“Sensitive Environment”** The following is a list of sensitive environments as used in the Hazard Ranking system:

Critical habitat for designated endangered or threatened species; Marine Sanctuary; National Park; Designated Federal Wilderness Area, Critical areas identified under the Clean Lakes Program; National Monument; National Lakeshore Recreational Area; Habitat known to be used by Federal designated or proposed endangered or threatened species; National Preserve; National or State Wildlife Refuge; Federal land designated for the protection of natural ecosystems; Administratively Proposed Federal Wilderness Area; Spawning areas critical for the maintenance of fish/shellfish species within a river, lake, or coastal waters; Migratory pathways and feeding areas critical for maintenance of anadromous fish species within river reaches or areas of lakes or coastal tidal waters in which the fish spend extended periods of time; Terrestrial areas utilized for breeding by large or dense aggregations of animals; National river reach designated as Recreational; Habitat known to be used by state designated endangered or threatened species; Habitat known to be used by species under review as to its Federal endangered or threatened status; Federally-designated Scenic or Wild River; State land designated for wildlife or game management; State-designated Scenic or Wild River; State-designated Natural Areas; Particular areas, relatively small in size, important to maintenance of unique biotic communities; State-designated areas for the protection or maintenance of aquatic life; Wetlands.

See Federal Register, vol. 55, pp. 51624 and 51648 for additional information regarding definitions. Under the Hazard Ranking System, wetlands are tiered on the basis of size. See Federal Register, vol. 55, pp. 51625 and 51662 for additional information. The Ohio EPA designates wetlands based on quality and size. The Ohio EPA Division of Surface Water should be contacted regarding the classification of wetlands.

**“Site”** means any parcel or multiple parcels of real property, contiguous or non-contiguous, or portion of such property or properties, where the treatment, storage, disposal and/or the discharge into the waters of the state of industrial waste or other wastes or hazardous substances and petroleum, has occurred, including any other area where these hazardous substances and petroleum have migrated or threatened to migrate.

**“Sub-acute (Repeated-Dose Study)”** means an exposure to a substance for approximately 14 days. Subacute toxicity tests are performed to obtain information on the toxicity of a chemical after repeated administration and as an aid to establish the doses for sub-chronic studies (Amdur et al., 1991).

**“Sub-chronic Exposure”** means sub-chronic exposures last for a range of times, however, 90 days is the most common exposure duration for most rodents and mammals. Sub-chronic exposures will be assessed with multiple administrations of the compound under investigation.

**“Systemic Effects or Systemic Toxicity”** means toxic effects as a result of absorption and distribution of a toxicant to a site distant from its entry point, at which point effects are produced. Not all chemicals that produce systemic effects cause the same degree of toxicity in all organs.

**“Target Organ”** means the biological organ(s) most adversely effected by exposure to a chemical substance.

**“Threshold”** means the dose or exposure below which no deleterious effect is expected to occur.

**“Trophic level”** means a feeding stratum in a food chain of an ecosystem characterized by organisms that occupy a similar functional position in the ecosystem.

**“Trophic”** means of, relating to, or marked by a specified kind of nutrition or diet.

**“UCL, or ninety-five per cent upper confidence limit or ninety five UCL”** means the upper limit of an interval within a frequency distribution curve in which the observed mean of a data set will occur ninety-five percent of the time.

**“Uncertainty Factor (UF)”** means one of several, generally one half order of magnitude (3 based on a logarithmic scale) or one order of magnitude factors, used in operationally deriving the ERfD from experimental data. UFs are intended to account for (1) the variation in sensitivity among the members of the same species; (2) the uncertainty in extrapolating animal data from one species to another, *i.e.*, interspecies variability; (3) the uncertainty in extrapolating from data obtained in a study with less-than-lifetime exposure to lifetime exposure, *i.e.*, extrapolating from sub-chronic to chronic exposure; (4) the uncertainty in extrapolating from a LOAEL rather than from a NOAEL; and (5) the uncertainty associated with extrapolation from animal data when the data base is incomplete.

**“Wetlands”** means those areas that are inundated by surface or ground water at a frequency and duration sufficient to support, and that under normal circumstances do support, a prevalence of vegetation typically adapted for life in saturated soil conditions. Additional information on wetlands including the classification of wetlands can be found at:

<http://www.epa.ohio.gov/dsw/wetlands/WetlandEcologySection.aspx>



## CHAPTER 7

# LITERATURE CITED

Barnthouse, L. W., G. W. Suter II, S. M. Bartell, J. J. Beauchamp, R. H. Gardner, E. Linder, R. V. O'Neill, and A. E. Rosen. 1986. *User's Manual for Ecological Risk Assessment*. ORNL-6251. Oak Ridge National Laboratory, Oak Ridge, Tennessee DTSC.

Clifford, P.A., D.E. Barchers, D.F. Ludwig, R.L. Sielken, J.S. Klingensmith, R.V. Graham, and R.L. Banton. 1995. "An approach to quantifying spatial components of exposure for ecological risk assessment." *Environmental Toxicology and Chemistry* **14**, 895-906.

MacDonald D.D., C.G. Ingersoll, and T.A. Berger. 2000. "Development and Evaluation of Consensus-based Sediment Quality Guidelines for Freshwater Ecosystems." *Archives of Environmental Contamination and Toxicology* **39**, 20-31.

Maughan J.T. 1993. *Ecological Assessment of Hazardous Waste Sites*. Van Nostrand Reinhold: New York.

Menzie C, M. H. Henning, J. Cura, K. Finkelstein, J. Gentile, J. Maughan, D. Mitchell, S. Petron, B. Potocki, S. Svirsky, and P. Tyler. 1996. "Special report of the Massachusetts weight-of-evidence workgroup: A weight-of-evidence approach for evaluating ecological risks." *Human and Ecological Risk Assessment* **2**, 277-304.

Moore D.R.J., and G.R. Biddinger. 1996. "The interaction between risk assessors and risk managers during the problem formulation phase." *Environmental Toxicology and Chemistry* **14**, 2013-2014.

Suter II G.W. 1993. *Ecological Risk Assessment*. Lewis Publishers: Boca Raton, Florida.

Suter II, G.W., R.A. Efroymson, B.E. Sample, and D.S. Jones. 2000. *Ecological Risk Assessment for Contaminated Sites*. Lewis Publishers: Washington DC.

U.S. DOI. 1987. *Guidance on Use of Habitat Evaluation Procedures and Suitability Index Models for CERCLA Application, Type B Technical Information Document*. CERCLA 301 Project, U.S. Department of the Interior, Washington, DC.

U.S. EPA. 1989. *Ecological Assessment of Hazardous Waste Sites: A Field and Laboratory Reference*. EPA/600/3-89/013. Environmental Research Laboratory, U.S. Environmental Protection Agency, Corvallis, Oregon.

U.S. EPA. 1989. *Risk Assessment Guidance for Superfund, Volume II, Environmental Evaluation Manual*. EPA/540/1-89/001. Office of Emergency and Remedial Response, U.S. Environmental Protection Agency, Washington, D.C.

U.S. EPA, 1992. *Framework for Ecological Risk Assessment*. EPA/630/R-92/001. Risk Assessment Forum, U.S. Environmental Protection Agency: Washington, DC.

U.S. EPA, 1992. *Eco Update Intermittent Bulletin 1(4): Developing a Work Scope for Ecological Assessments*. Publication 9345.0-05I. Office of Solid Waste and Emergency Response, U.S. Environmental Protection Agency: Washington, D.C.

U.S. EPA, 1992. *Supplemental Guidance to RAGS: Calculating the Concentration Term*. Publication

9285.7-081. Office of Solid Waste and Emergency Response, U.S. Environmental Protection Agency: Washington, D.C.

U.S. EPA, 1993. *Wildlife Exposure Factors Handbook, Volume I of II*. EPA/600/R-93/187a. Office of Research and Development, U.S. Environmental Protection Agency, Washington, D.C.

U.S. EPA, 1993. *Wildlife Exposure Factors Handbook, Volume II of II*. EPA/600/R-93/187b. Office of Research and Development, U.S. Environmental Protection Agency, Washington, D.C.

U. S. EPA, 1995. EPA Risk Characterization Policy. March 21, Memorandum from Carol Browner, Administrator, to EPA staff, Office of the Administrator, U.S. Environmental Protection Agency: Washington, DC.

U.S. EPA, 1996. *Ecological Significance and Selection of Candidate Assessment Endpoints*. EPA 540/F-95/037, Publication 9345.0-11FSI. Office of Solid Waste and Emergency Response, U.S. Environmental Protection Agency: Washington, DC.

U.S. EPA, 1997. *Ecological Risk Assessment Guidance for Superfund: Process for Designing and Conducting Ecological Risk Assessments, Interim Final*. EPA/540/R-97/006. Office of Solid Waste and Emergency Response, U.S. Environmental Protection Agency: Edison, New Jersey.

U.S. EPA, 1998. *Guidelines for Ecological Risk Assessment, Final*. EPA/630R-95/002F. Risk Assessment Forum, U.S. Environmental Protection Agency: Washington DC.

U.S. EPA, 1998. Guidelines for ecological risk assessment; Notice, Federal Register, Vol. 63, No. 93/ Thursday, May 14, 1998.