

US EPA ARCHIVE DOCUMENT



UNITED STATES ENVIRONMENTAL PROTECTION AGENCY
WASHINGTON, D.C. 20460

Analytical Chemistry Section
Building 306, BARC-East
Beltsville, Maryland 20705

OCT 12 1994

OFFICE OF
PREVENTION, PESTICIDES
AND TOXIC SUBSTANCES

MEMORANDUM

SUBJECT: PP#1F3995. Method Validation of three chemicals on Pecans, RH-7592 (Fenbuconazole), RH-9129, and RH-9130.

FROM: Paul E. Golden, Chemist *Paul Golden*
Analytical Chemistry Section

THRU: *Harvey K. Hundley* Harvey K. Hundley, Head
Analytical Chemistry Section

THRU: Donald A. Marlow, Chief *DA*
Analytical Chemistry Branch

TO: Elizabeth Haeberer, Head
Tolerance Petition Section II
Chemistry Branch I-Tolerance Support
Health Effects Division (H7509C)

INTRODUCTION

The Analytical Chemistry Laboratory was requested by the Chemistry Branch-I Tolerance Support to conduct a method validation for the fungicide Fenbuconazole (RH-7592) and two metabolites RH-9129 and RH-9130 on pecans. Analyses were requested to be run in duplicate using unfortified control samples and samples fortified at 0.05 ppm and 0.10 ppm.

The analytical method submitted for validation from Rohm and Haas Company was titled: "Residue Analytical Method for Parent RH-7592 and Its Metabolites RH-9129, RH-9130, and RH-6467 in Pecans"; Rohm and Haas Technical Report No. 34-91-14; dated March 5, 1991 (MRID 3418925-03).

METHOD SUMMARY

RH-7592 and its metabolites RH-9129 and RH-9130 are extracted from pecans by Soxhlet extraction with hexane/2-propanol. The extract is concentrated to an oily residue. The residue is dissolved in toluene/acetone and cleaned up on Silica gel and then Florisil. The samples are further cleaned up with a C-18 solid phase extraction cartridge. Residues are determined by gas chromatography using a 30 meter, 0.53mm ID RTx-35 capillary column and a nitrogen phosphorus detector.

COMMENTS

1. All standards used for this method validation were supplied from RTP.
2. Column profiles were performed on the silica gel and Florisil cleanup media using a multi-component standard to verify proper eluent fraction collection. Pre-wash and post-wash fractions were collected before and after the prescribed collection fraction. Fenbuconazole and its metabolites eluted only in the fraction described by the method. The elution scheme did not require modification.
3. ACL utilized a Hewlett-Packard HP5890 Gas Chromatograph equipped with a nitrogen-phosphorus detector. Rohm and Haas used a Varian GC. Carrier and detector gas flows were adjusted to meet specifications for the HP 5890 NP detector.
4. The NP detector was operated at 290° C instead of 300 ° C and without the use of the detector make-up gas as cited in the method. The lower temperature was selected to minimize column bleed which shortens the lifetime of the detector.
5. The method prescribes the use of calibration curves to determine sample concentrations. ACL determined sample concentrations from a ratio of sample response to the average of bracketing standard response.
6. The method provided acceptable recovery on pecans at the requested spiking levels for RH-7592, RH-9130, and RH-9129. There was evidence, however, of significant signal enhancement caused by the matrix. The data reported below are therefore believed to be artificially higher than actual. The data submitted by the registrant includes several high recovery values which may also be caused by a problem of signal enhancement. Additional clean-up procedures should be investigated to correct the problem of signal enhancement found at ACL.
7. One chemist can have a set of six (6) samples ready for GC analysis within 8 hours, exclusive of the Soxhlet extraction time.
8. The sensitivity of the method based on the optimum parameters used, was estimated for this method validation. The estimates in pecans are as follows:

<u>Analyte</u>	<u>Estimated Limit of Detection</u>
RH-7592	0.001 ppm
RH-9130	0.002 ppm
RH-9129	0.002 ppm

METHOD VALIDATION RESULTS:

Commodity	Chemical Added	PPM Added	PPM Found	Percent Recovery
Pecans	RH-7592	0.00	N.D. ¹	-
		0.00	N.D. ¹	-
		0.05	0.054	108
		0.05	0.067	134
		0.10	0.100	100
		0.10	0.109	109
Pecans	RH-9130	0.00	N.D. ¹	-
		0.00	N.D. ¹	-
		0.05	0.053	106
		0.05	0.065	130
		0.10	0.101	101
		0.10	0.106	106
Pecans	RH-9129	0.00	N.D. ¹	-
		0.00	N.D. ¹	-
		0.05	0.051	102
		0.05	0.064	128
		0.10	0.099	99.0
		0.10	0.102	102

1. N.D. = Less than 0.001 ppm for RH-7592, less than 0.002 ppm for RH-9130, less than 0.002 ppm for RH-9129.

Modifications to Method (major or minor):

Refer to Comments 3 through 5.

Special precautions to be taken:

None

Source of analytical standards:

US EPA Pesticides Repository, RTP

If derivatized standard is used, give source:

N/A

Instrumentation for quantitation:

HP 5890 GLC/NP detection

Instrumentation for confirmation:

N/A

If instrument parameters differ from those given in the method, list parameters used:

Refer to Comments 3 & 4.

Commercial sources for any special chemicals or apparatus:

N/A

Additional comments:

See comment section of report.

Chromatograms:

Copies of standard curve, sample calculations, pecan controls, low and high level fortifications, and standards are included.

TMV Pre-review of Febuconazole (RH-7592)

Reviewed by: Everett S. Greer, Jr. *EG*

Date: 4-8-94

Laboratory assignment number: B94-40,41

Analytes: RE-7592, RH-9129 and RH-9130

Commodities: Pecans

Method: Residue Analytical Method for Parent RH-7592 and its Metabolites RH-9129, RH-9310, and RH-6467 in Pecans

Commodity: Pecans

E. Analytical procedure

2. Extraction

ACL safety policy precludes overnight Soxhlet extractions.

4. Gas chromatography

a. Preparation of standard curves

This section states that the response of the analytes "are usually quadratic in nature." If instrument response is not linear, standard and sample response must be carefully matched if a standard curve is not used for quantitation.

5. Method of calculation

b. Component residue concentration

Average recovery values are used for calculating residue levels. This practice should not be incorporated in a tolerance enforcement method.

Additional reviewer's comments

1. The registrant should be asked if the soxhlet extraction can be shortened.

2. Recovery data and chromatograms are provided for samples fortified at less than the requested levels.

3. ILV recovery data and chromatograms are included for pecans fortified at 1/2X and 1X the requested tolerance.

ANALYTICAL CHEMISTRY BRANCH
SCREEN FOR RESIDUE METHODS FOR TMV

- A. LABORATORY ASSIGNMENT NUMBER: B 94-90, 41
- B. PP#: 11-3995
- C. TECHNICAL REVIEWER: _____
- D. DATE: 4-8-94
- E. ANALYTES/LEVEL: PE-7592, RH-9129, RH-9130 / 0.05, 0.10 PPM
- F. COMMODITIES: Pecans
- G. METHOD: Residue Analytical Method for Paracet RH-7592 and its Metabolites RH-9129, RH-9130, and RH-6467 in Pecans

The Analytical Chemistry Section has been asked to screen the residue chemistry methods submitted by the registrant in order to determine if they contain the essential requirements identified in the Residue Chemistry Guidelines. Full scientific review and laboratory evaluation of those methods will take place after the initial screen. The following items need to be resolved before the analytical method can be evaluated.

- | | <u>YES</u> | <u>NO</u> |
|--|-------------------------------------|-------------------------------------|
| 1. Does the method use exotic equipment and/or supplies that are not commercially available in the U.S.? | <input type="checkbox"/> | <input checked="" type="checkbox"/> |
| 2. Does the method require any new equipment before the laboratory work begins? | <input type="checkbox"/> | <input checked="" type="checkbox"/> |
| 3. Are chromatograms included? | <input checked="" type="checkbox"/> | <input type="checkbox"/> |
| a. Is (are) peak(s) of interest sufficiently resolved from other peaks? | <input checked="" type="checkbox"/> | <input type="checkbox"/> |
| b. Has registrant included chromatograms of analyses at or below tolerance on all crop types for which tolerance is requested by HED? | <input checked="" type="checkbox"/> | <input type="checkbox"/> |
| c. Do the control samples have reasonably low levels of the analyte in relation to the proposed tolerance? | <input checked="" type="checkbox"/> | <input type="checkbox"/> |
| d. Is the method sufficiently sensitive and specific to measure and identify the residues at levels specified by HED in the TMV request? | <input checked="" type="checkbox"/> | <input type="checkbox"/> |

FIGURE 1: RH-7592 Standard Curve and Regression Data.

B94-40,41 FENBUCONAZOLE TMV

Compound: RH-7592
 Instrument: GC/NPD
 Date: 7/29/94

Linearity on Rtx-35 Column

ug/mL	pk ht. 1	pk ht. 2	pk ht. 3	ave pk ht.	calc pk ht.
0.126	1125	1191	1068	1128	
0.251	2506	2671	2014	2397	
0.502	6258	5819	5917	5998	
0.753	9006	8188	9005	8733	
1.00	12122	14006	14034	13387	
0.00					-925
1.20					15611

Regression Output:

Constant	-925.09044
Std Err of Y Est	553.1986
R Squared	0.9906523
No. of Observations	5
Degrees of Freedom	3
X Coefficient(s)	13779.8071
Std Err of Coef.	772.812802

B94-40,41 RH-7592

Linearity on Rtx-35 Column

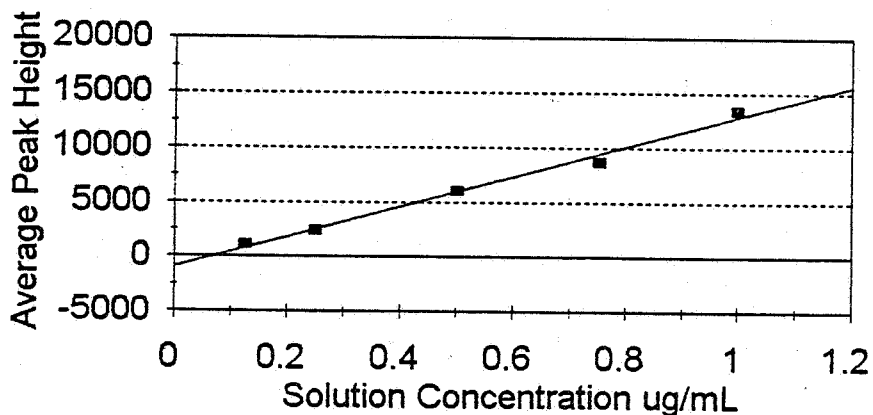

■ Actual Data Points — Calculated Line

FIGURE 2: RH-9130 Standard Curve and Regression Data.

B94-40,41 FENBUCONAZOLE TMV

Compound: RH-9130
 Instrument: GC/NPD
 Date: 7/29/94

Linearity on Rtx-35 Column

ug/mL	pk ht. 1	pk ht. 2	pk ht. 3	ave pk ht.	calc pk ht.
0.126	593	630	550	591	
0.251	1253	1398	1004	1218	
0.502	3212	3025	3038	3092	
0.753	4546	4159	4514	4406	
1.00	5903	7113	7023	6680	
0.00					-413
1.20					7818

Regression Output:

Constant	-413.11795
Std Err of Y Est	261.988353
R Squared	0.99153025
No. of Observations	5
Degrees of Freedom	3
X Coefficient(s)	6858.886678
Std Err of Coef.	365.9950569

B94-40,41 RH-9130

Linearity on Rtx-35 Column

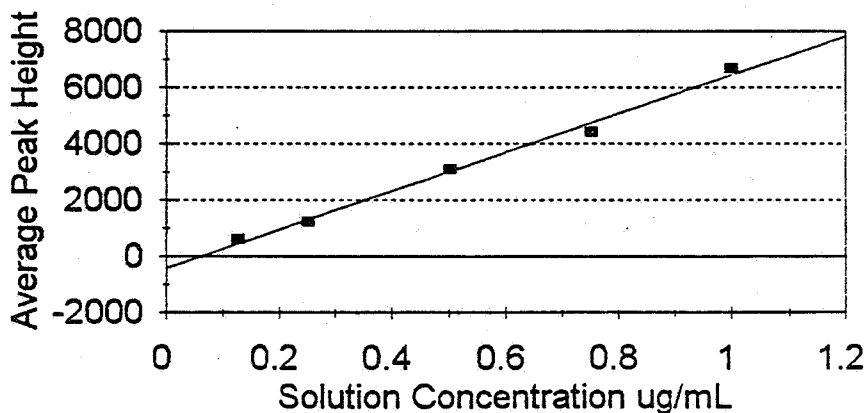

■ Actual Data Points — Calculated Line

FIGURE 3: RH-9129 Standard Curve and Regression Data.

B94-40,41 FENBUCONAZOLE TMV

Compound: RH-9129
 Instrument: GC/NPD
 Date: 7/29/94

Linearity on Rtx-35 Column

ug/mL	pk ht. 1	pk ht. 2	pk ht. 3	ave pk ht.	calc pk ht.
0.126	545	570	519	545	
0.251	1179	1271	919	1123	
0.502	2955	2724	2773	2817	
0.753	4119	3742	4097	3986	
1.00	5425	6447	6407	6093	
0.00					-367
1.20					7110

Regression Output

Constant	-367.0429
Std Err of Y Est	253.00767
R Squared	0.9904385
No. of Observations	5
Degrees of Freedom	3
X Coefficient(s)	6230.7045
Std Err of Coef.	353.44914

B94-40,41 RH-9129

Linearity on Rtx-35 Column

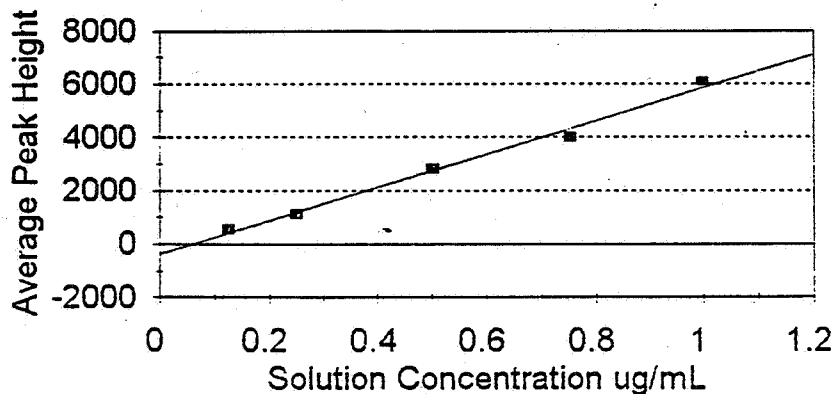

■ Actual Data Points — Calculated Line

FIGURE 4: Sample Spreadsheet with Calculation Equations.

B94-40,41 FENBUCONAZOLE TMV

Instrument: GC/NPD
Date: 8/31/94 injection of 8/10/94 samples

RH-7592

Sample ID	Peak Height	Peak Height	Average Peak Ht	Std. Conc (ug/mL)	ppm Found	ppm Added	% Recovery
Std	4902	4670	4569	0.252			
C-1(10)			0		0.000	0.00	
C-2(10)			0		0.000	0.00	
Std	4654	4049	4454	0.252			
.05-1(10)	4302	5275	4789		0.054	0.05	108
.05-2(10)	6384	5490	5937		0.067	0.05	134
Std	4600	4511		0.252			
Std	9974	9612	10323	0.502			
0.1-1(10)	11018	9522	10270		0.100	0.10	100
0.1-2(10)	11862	10616	11239		0.109	0.10	109
Std	11509	10196		0.502			

RH-9130

Sample ID	Peak Height	Peak Height	Average Peak Ht	Std. Conc (ug/mL)	ppm Found	ppm Added	% Recovery
Std	2900	2749	2713	0.252			
C-1(10)	25		25		0.000	0.00	
C-2(10)			0		0.000	0.00	
Std	2749	2452	2663	0.252			
.05-1(10)	2527	3115	2821		0.053	0.05	106
.05-2(10)	3749	3158	3454		0.065	0.05	130
Std	2738	2713		0.252			
Std	5842	5534	5946	0.502			
0.1-1(10)	6488	5524	6006		0.101	0.10	101
0.1-2(10)	6613	5951	6282		0.106	0.10	106
Std	6510	5897		0.502			

RH-9129

Sample ID	Peak Height	Peak Height	Average Peak Ht	Std. Conc (ug/mL)	ppm Found	ppm Added	% Recovery
Std	2576	2438	2405	0.252			
C-1(10)			0		0.000	0.00	
C-2(10)			0		0.000	0.00	
Std	2428	2176	2361	0.252			
.05-1(10)	2172	2587	2380		0.051	0.05	102
.05-2(10)	3230	2736	2983		0.064	0.05	128
Std	2437	2402		0.252			
Std	5133	4835	5186	0.502			
0.1-1(10)	5565	4644	5105		0.099	0.10	99
0.1-2(10)	5533	4977	5255		0.102	0.10	102
Std	5651	5124		0.502			

$$\text{ppm found} = \frac{(\text{ug/mL std}) \times (\text{Average Height Sample}) \times (\text{Final Volume } \{5\text{mL}\})}{(\text{Average Height Std}) \times (\text{Sample Weight } \{25\text{g}\})}$$

$$\% \text{ Recovery} = \frac{\text{ppm Found} \times 100}{\text{ppm Added}}$$

CHROMATOGRAM 1: Mixed Fenbuconazole Standard - 0.252 ug/mL each RH-7592, RH-9130, RH-9129. (0.05 ppm equivalents for a 5 mL final volume of a 25 g pecan sample).

RUN # 47 AUG 31, 1994 22:44:25
 START

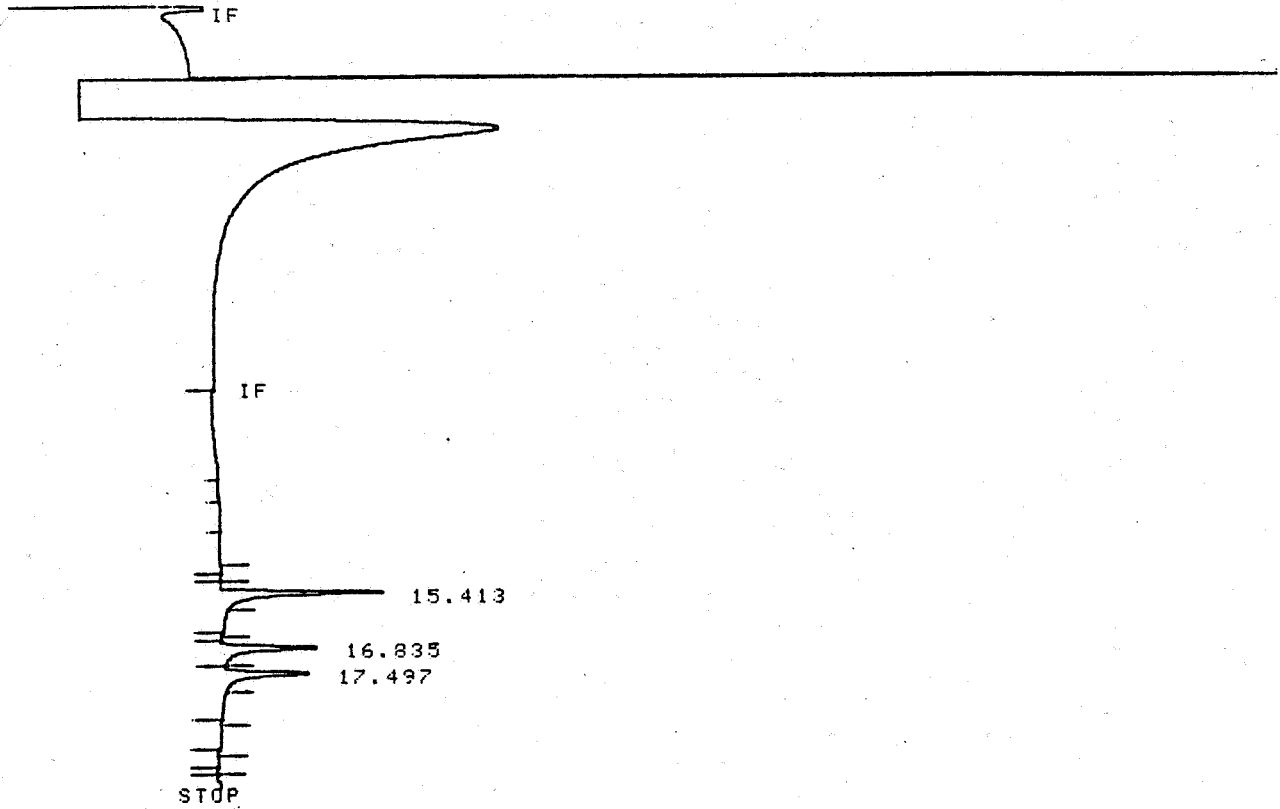

Closing signal file B:\08F09A4A.BNC

RUN# 47 AUG 31, 1994 22:44:25

SAMPLE NAME: CALSTDA SAMPLE# 66
 3uL INJ, 0.252ug/mL MIXED FENBUCONAZOLE STD IN 100/3

SIGNAL FILE: B:\08F09A4A.BNC

B94-40.41 FENBUCONAZOLE TMV

HEIGHT%

RT	HEIGHT	TYPE	WIDTH	HEIGHT%	
15.413	4511	PB	.132	46.86266	RH-7592
16.835	2713	PB	.147	28.18408	RH-9130
17.497	2402	BB	.156	24.95326	RH-9129

TOTAL HEIGHT= 9626
 MUL FACTOR=1.0000E+00

CHROMATOGRAM 2: Pecan Control - 25g/5mL final volume.

RUN # 39 AUG 31, 1994 19:45:38
START

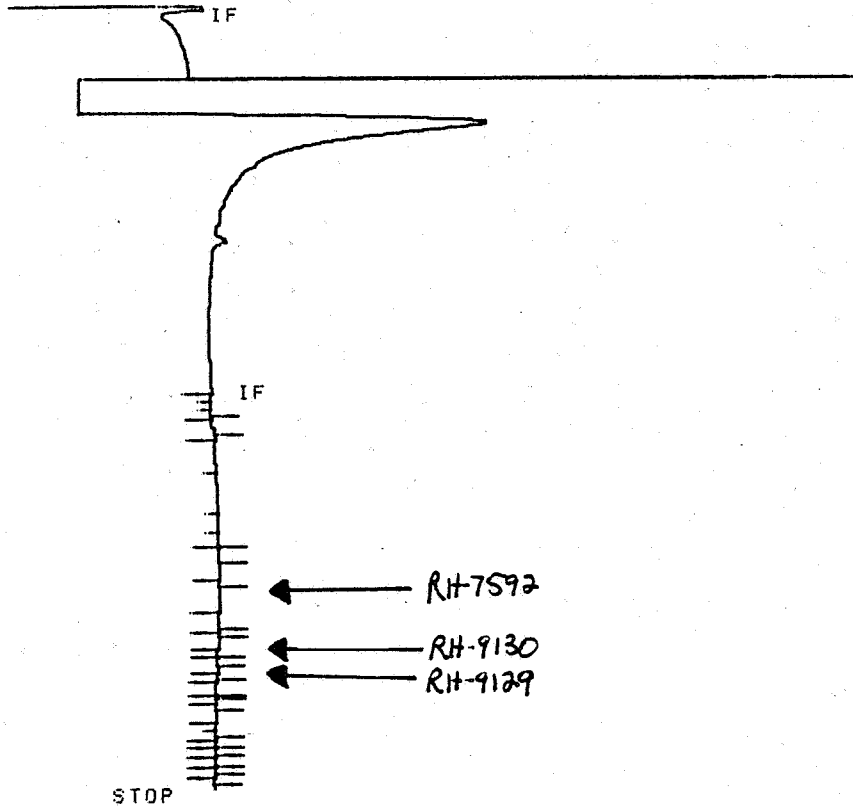

Closing signal file B:Q8F07063.BNC

RUN# 39 AUG 31, 1994 19:45:38

SAMPLE NAME: C-2(10) SAMPLE# 62
3uL INJ, PECAN CONTROL, 25g/5mL FINAL VOL IN 100/3

SIGNAL FILE: B:Q8F07063.BNC

B94-40.41 FENBUCONAZOLE TMV

NO RUN PEAKS STORED

CHROMATOGRAM 3: Pecan Fortification, 0.05 ppm each RH-7592, RH-9130, RH-9129 - 25g/5mL final volume.

RUN # 44 AUG 31, 1994 21:37:19
 START

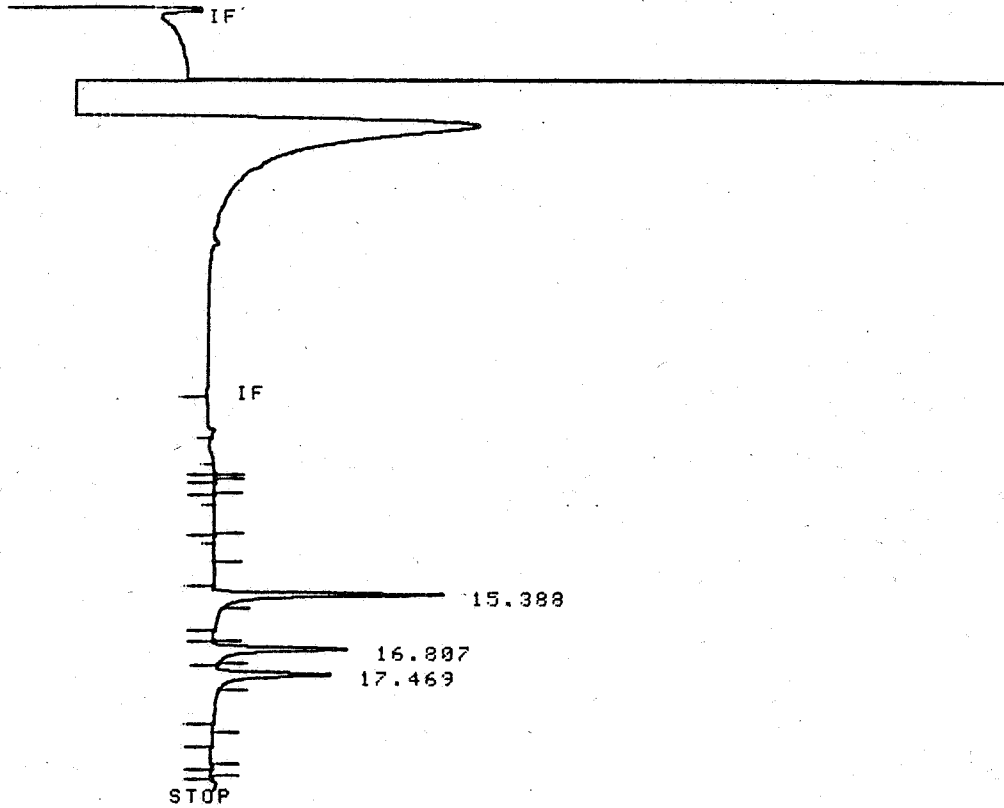

Closing signal file B:Q8F08A90.BNC

RUN# 44 AUG 31, 1994 21:37:19

SAMPLE NAME: .05-2(10) SAMPLE# 65
 30L INJ, PECAN SPIKE, 25g + 1.26ug MIXED STD/5mL FINAL VOL IN 100/3

SIGNAL FILE: B:Q8F08A90.BNC

B94-40,41 FENBUCONAZOLE TMV

HEIGHT%:

RT	HEIGHT	TYPE	WIDTH	HEIGHT%	
15.388	6384	PB	.121	47.77370	RH-7592
16.807	3749	BB	.133	28.05509	RH-9130
17.469	3230	PB	.146	24.17122	RH-9129

TOTAL HEIGHT= 13363
 MUL FACTOR=1.0000E+00

CHROMATOGRAM 4: Mixed Fenbuconazole Standard - 0.502 ug/mL each RH-7592, RH-9130, RH-9129. (0.1 ppm equivalents for a 5 mL final volume of a 25 g pecan sample).

RUN # 55 SEP 1, 1994 01:43:07
 START

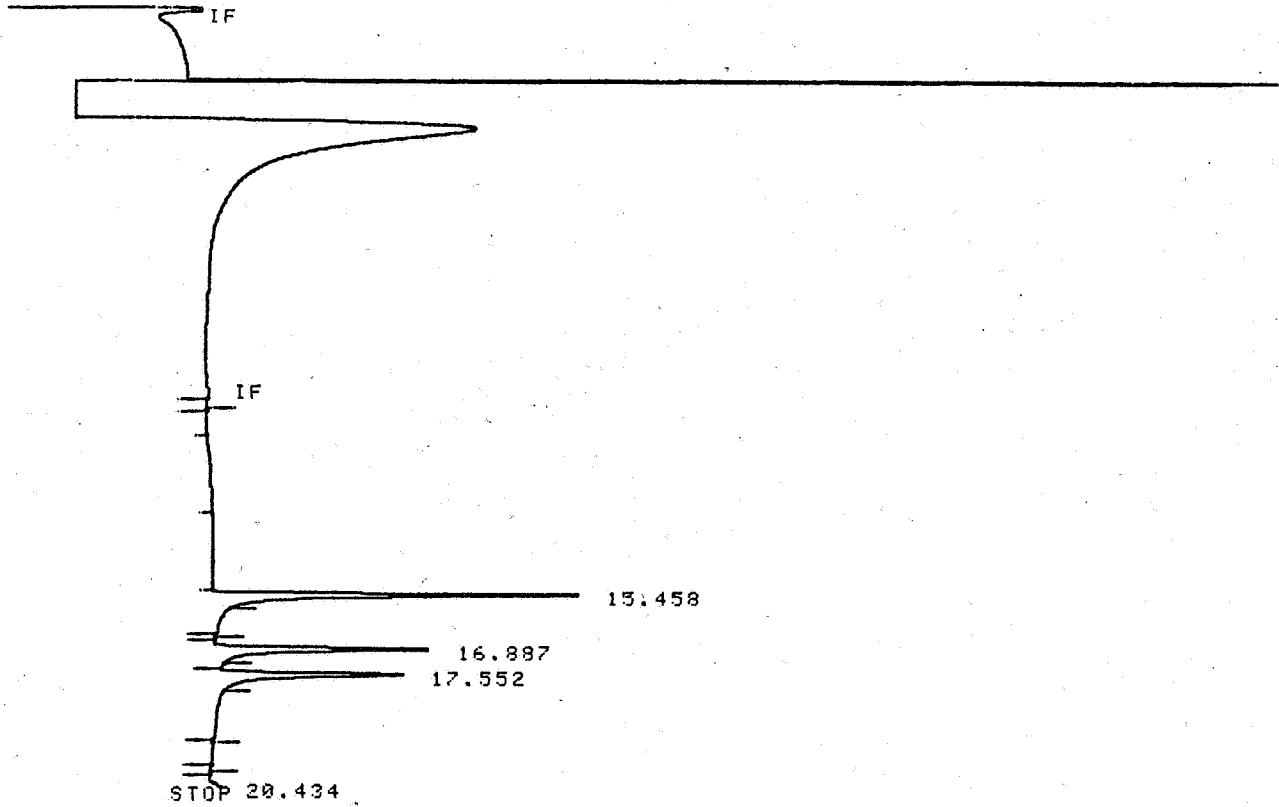

Closing signal file B:Q8F0C42C.BNC

RUN# 55 SEP 1, 1994 01:43:07

SAMPLE NAME: CALSTDB SAMPLE# 70
 3uL INJ. 0.502ug/mL MIXED FENBUCONAZOLE STD IN 100/3

SIGNAL FILE: B:Q8F0C42C.BNC

894-40,41 FENBUCONAZOLE TMV

HEIGHT%

RT	HEIGHT	TYPE	WIDTH	HEIGHT%	
15.458	10196	PB	.122	47.44974	RH-7592
16.887	5897	PB	.135	27.44322	RH-9130
17.552	5124	BB	.147	23.84586	RH-9129
20.434	271	I PH	.127	1.26117	

TOTAL HEIGHT= 21488
 MUL FACTOR=1.0000E+00

CHROMATOGRAM 5: Pecan Fortification, 0.1 ppm each RH-7592, RH-9130, RH-9129 - 25g/5mL final volume.

RUN # 52 SEP 1, 1994 00:36:07

START

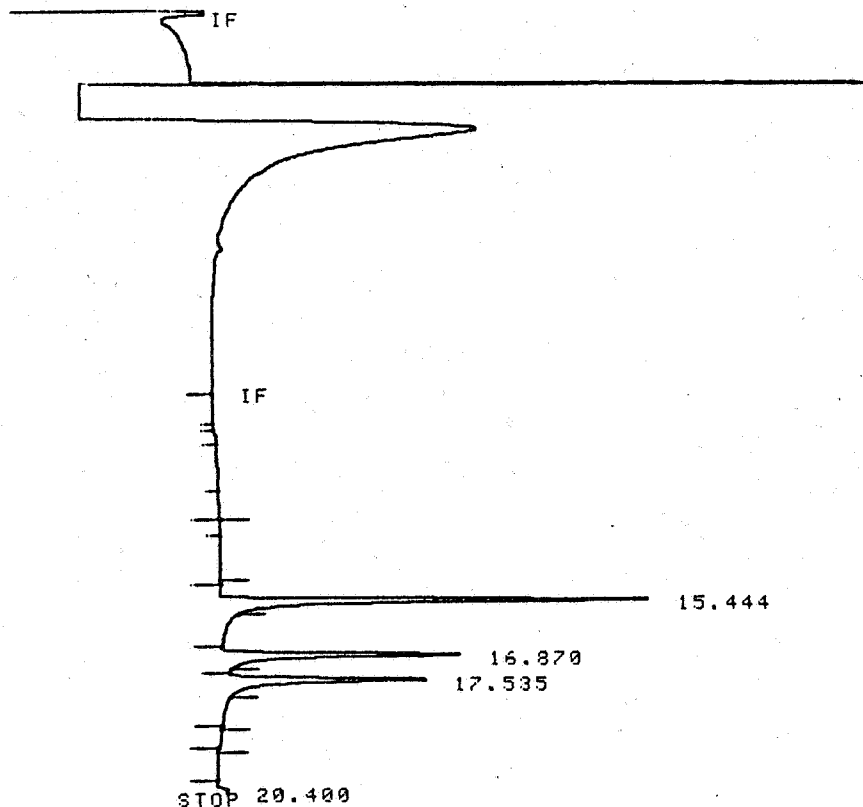

Closing signal file B:\Q8F0B478.BNC

RUN# 52 SEP 1, 1994 00:36:07

SAMPLE NAME: 0.1-2(10) SAMPLE# 69
 3UL INJ, PECAN SPIKE, 25G + 2.51ug MIXED STD/5ML FINAL VOL IN 100/3

SIGNAL FILE: B:\Q8F0B478.BNC

B94-40.41 FENBUCONAZOLE TMV

HEIGHT%

RT	HEIGHT	TYPE	WIDTH	HEIGHT%	
15.444	11862	PB	.118	48.68059	RH-7592
16.870	6613	BB	.138	27.13916	RH-9130
17.535	5533	BB	.149	22.70694	RH-9129
20.400	359	I PH	.144	1.47330	

TOTAL HEIGHT= 24367

MUL FACTOR=1.0000E+00