

US EPA ARCHIVE DOCUMENT

Environmental Technology Verification Report

Paint Overspray Arrestor
ATI
OSM 200 System

US EPA ARCHIVE DOCUMENT

Prepared by



Research Triangle Institute

Under a Cooperative Agreement with



U.S. Environmental Protection Agency

ETV ✓ ETV ✓ ETV ✓

Environmental Technology Verification Report

Paint Overspray Arrestor

ATI OSM 200 System

Prepared by

Kathleen Owen
James Hanley
Jack Farmer

Air Pollution Control Technology Program
Research Triangle Institute
Research Triangle Park, NC 27709-2194

EPA Cooperative Agreement CR 826152-01-2

EPA Project Manager: Theodore G. Brna
Air Pollution Prevention and Control Division
National Risk Management Research Laboratory
Research Triangle Park, NC 27711

March 2000

Notice

This document was prepared by the Research Triangle Institute (RTI) under Cooperative Agreement No. CR826152-01-2 with the U.S. Environmental Protection Agency (EPA). The document has been subjected to EPA's peer and administrative reviews and has been approved for publication. Mention of corporation names, trade names, or commercial products does not constitute endorsement or recommendation for use of specific products.

Availability of Verification Statement and Report

Copies of the public Verification Statement and Verification Report are available from the following:

1. **Research Triangle Institute**

P.O. Box 12194
Research Triangle Park, NC 27709-2194

Web site: <http://etv.rti.org/apct/index.html>
or <http://www.epa.gov/etv> (*click on partners*)

2. **USEPA / APPCD**

MD-4
Research Triangle Park, NC 27711

Web site: <http://www.epa.gov/etv/library.htm> (*electronic copy*)
<http://www.epa.gov/ncepihom/>

Abstract

Paint overspray arrestors (POAs) were evaluated by the Air Pollution Control Technology (APCT) pilot of the Environmental Technology Verification (ETV) Program. The performance factor verified was the particle filtration efficiency as a function of size for particles smaller than 10 μm . The APCT ETV Program developed a generic verification protocol for testing filtration efficiency that is based on EPA Method 319. The protocol was developed by RTI, reviewed by a technical panel of experts, and approved by EPA. The protocol addresses several issues that Method 319 does not cover, including periodic testing, acquisition of POAs for testing, and product definition. A Test/Quality Assurance Plan was prepared which addresses the test procedure and quality assurance and quality control requirements for obtaining verification data of sufficient quantity and quality to satisfy the data quality objectives.

RTI performed tests on ATI's OSM 200 System during the period September 3-8, 1999. Filter efficiencies were determined. For ready comparison, the filtration efficiency requirements of the National Emission Standards for Hazardous Air Pollutants (NESHAP) are tabulated with the test results. The results indicate that the OSM 200 System met the NESHAP requirements for existing sources.

Table of Contents

	<u>Page</u>
Verification Statement	i
Notice	vii
Availability of Verification Statement and Report	viii
Abstract	ix
List of Figures	xi
List of Tables	xi
List of Abbreviations and Acronyms	xii
Acknowledgments	xiii
Section 1. Introduction	1
Section 2. Verification Test Description	1
2.1. Selection of Paint Overspray Arrestors for Testing	3
Section 3. Description of Arrestor	3
Section 4. Verification of Performance	3
4.1. Quality Assurance	3
4.2. Results	3
4.3. Limitations and Applications	4
Section 5. References	4
Appendix A. Description of the Test Rig and Methodology	A-1
Appendix B. Certificates of Calibration	B-1
Appendix C. Fractional Efficiency Data Sheets	C-1

List of Figures

	<u>Page</u>
Figure 1. Photograph of the ATI OSM 200 System paint overspray arrestor	iii
Figure 2. Triplicate solid-phase particle removal efficiency curves for ATI OSM 200 System paint overspray arrestor	7
Figure 3. Average of the solid-phase particle removal efficiency curves for ATI OSM 200 System paint overspray arrestor.	8
Figure 4. Triplicate liquid-phase particle removal efficiency curves for ATI OSM 200 System paint overspray arrestor	9
Figure 5. Average of the liquid-phase particle removal efficiency curves for ATI OSM 200 System paint overspray arrestor	10
Figure A-1. Schematic illustration of the fractional efficiency test rig	A-2

List of Tables

Table 1. Existing Sources: Liquid-Phase Challenge Aerosol Particles	iv
Table 2. Existing Sources: Solid-Phase Challenge Aerosol Particles	iv
Table 3. New Sources: Liquid-Phase Challenge Aerosol Particles	iv
Table 4. New Sources: Solid-Phase Challenge Aerosol Particles	iv
Table 5. Test Series	2
Table 6. Summary of Solid-Phase Test Results	5
Table 7. Summary of Liquid-Phase Test Results	6
Table 8. Summary of Pressure Drop Measurements	11
Table A-1. Physical and Aerodynamic Sizing Channels for the Calibration and Test Aerosols	A-6

List of Abbreviations and Acronyms

APCT	Air Pollution Control Technology
APPCD	Air Pollution Prevention and Control Division
ASME	American Society of Mechanical Engineers
cfm	cubic feet per minute
cm	centimeter
Diam.	Diameter
DQO	data quality objective
EPA	U.S. Environmental Protection Agency
ETV	Environmental Technology Verification
fpm	feet per minute
ft ³	cubic foot
g	gram
Geo.	geometric
HEPA	high efficiency particulate air
ID	inside diameter
in.	inch
kW	kilowatt
L	liter
mL	milliliter
mm	millimeter
m/s	meters per second
NESHAP	National Emission Standards for Hazardous Air Pollutants
OPC	optical particle counter
Pa	pascal
POA	paint overspray arrestor
PSL	polystyrene latex
QA	quality assurance
RTI	Research Triangle Institute
s or sec	second
µm or um	micrometer

Acknowledgments

RTI acknowledges the support of all those who helped plan and conduct the verification activities. In particular, we would like to thank Ted Brna, EPA Project Manager, and Paul Groff, EPA Quality Manager, of EPA's National Risk Management Research Laboratory in Research Triangle Park, NC. Finally we would like to acknowledge the assistance and participation of Alan Steiden of ATI.

For more information on the Paint Overspray Arrestor Verification Testing, contact

James Hanley
Research Triangle Institute
P.O. Box 12194
Research Triangle Park, NC 27709-2194
(919) 541-5811

For more information on the ATI OSM 200 System, contact

Alan Steiden
ATI
205 W. 17th St.
Ottawa, Kansas 66067
(785) 242-1811

SECTION 1 INTRODUCTION

The U. S. Environmental Protection Agency (EPA) has created the Environmental Technology Verification (ETV) Program to facilitate the deployment of innovative or improved technologies through performance verification and information dissemination. The ETV Program is intended to assist and inform those involved in the design, distribution, permitting, and purchase of environmental technologies.

The U.S. EPA's partner in the Air Pollution Control Technology (APCT) Program is Research Triangle Institute (RTI). The APCT Program, with the full participation of the technology developer, develops plans, conducts tests, collects and analyzes data, and reports findings. The evaluations are conducted according to a rigorous protocol and quality assurance and quality control oversight. The APCT Program verifies the performance of commercial-ready technologies used to control air pollutant emissions, with an emphasis on technologies for controlling particulate matter, volatile organic compounds, nitrogen oxides, and hazardous air pollutants. The Program develops standardized verification protocols and test plans, conducts independent testing of technologies, and prepares verification test reports and statements for broad dissemination.

SECTION 2 VERIFICATION TEST DESCRIPTION

The paint overspray arrestor was tested in accordance with the APCT "Generic Verification Protocol for Paint Overspray Arrestors"¹ and the "Test/QA Plan for Paint Overspray Arrestors."² This protocol incorporates all requirements of EPA Method 319: Determination of Filtration Efficiency for Paint Overspray Arrestors. Method 319³ is part of the National Emission Standards for Hazardous Air Pollutants (NESHAP) for Aerospace Manufacturing and Rework Facilities.⁴ The protocol also includes requirements for quality management, quality assurance, procedures for product selection, auditing of the test laboratories, and reporting format.

Filtration efficiency was computed from aerosol concentrations measured upstream and downstream of an arrestor installed in a laboratory test rig. The aerosol concentrations upstream and downstream of the arrestors were measured with an aerosol analyzer that simultaneously counts and sizes the particles in the aerosol stream. The aerosol analyzer covered the particle diameter size range from 0.3 to 10 μm in a series of contiguous sizing channels. Each sizing channel covered a narrow range of particle diameters. For example, channel 1 covered from 0.3 to 0.4 μm , channel 2 from 0.4 to 0.5 μm , and channel 15 from 7 to 10 μm . By taking the ratio of the downstream to upstream particle counts on a channel by channel basis, the filtration efficiency was computed for each of the sizing channels.

The upstream and downstream aerosol measurements were made while a test aerosol was injected into the air stream upstream of the arrestor [ambient aerosol is first removed from the upstream air with high efficiency particulate air (HEPA) filters on the inlet of the test rig]. This test aerosol spanned the particle

size range from 0.3 to 10 µm and provided a sufficient upstream concentration in each of the sizing channels to allow calculation of filtration efficiencies up to 99%.

The following series of tests were performed at a face velocity of 120 fpm (0.61 m/s):

- C Three arrestors were tested using a liquid-phase aerosol challenge,
- C Three arrestors were tested using a solid-phase aerosol challenge,
- C Seven “no-filter” control tests (one performed prior to each arrestor and reference filter test),
- C One HEPA filter control test, and
- C One reference filter control test.

The test series is exhibited in Table 5. Additional details on the test procedure are provided in Appendix A.

TABLE 5. TEST SERIES

RTI Test No.	TYPE OF TEST				Challenge Aerosol
	No-Filter	Test Arrestor	HEPA Filter	Reference Filter	
09039909	X				Solid-Phase
09079902				X	
09079903	X				
09079904		X			
09079905	X				
09079906		X			
09079907	X				
09079908		X			
08319904			X		
09089901	X				Liquid-Phase
09089902		X			
09089903	X				
09089904		X			
09089905	X				
09089907		X			

2.1 SELECTION OF PAINT OVERSPRAY ARRESTORS FOR TESTING

The test arrestors (OSM 200 System) were supplied to the test laboratory directly from the manufacturer (ATI) with a letter signed by Alan Steiden, National Sales & Marketing Manager, attesting that the 12 arrestors supplied were consistent with standard products offered to the field, were selected from existing inventory, and were not made to any special specifications.

SECTION 3 DESCRIPTION OF ARRESTOR

As shown in Figure 1 (page iii), the ATI OSM 200 System is a two-stage arrestor system consisting of a flat panel prefilter, the ASG Pad, with nominal dimensions of 24 x 24 x 2 in. (0.61 x 0.61 x 0.05 m) and a three-pocket bag filter, the OSM 200 3P Bag, with nominal dimensions of 24 x 24 x 15 in. (0.61 x 0.61 x 0.38 m). The prefilter media is green upstream and white downstream. The bag filter consists of white media with an internal support. The individual arrestors are labeled directly on the downstream side of the filter stating the name of the product, ATI ASG PAD or ATI OSM 200 3P, respectively. There is no indication of the flow direction or filter orientation, so the industry standard orientation with the bags extended horizontally in the direction of the airflow and the individual bags side-by-side, as opposed to stacked vertically, was used in the tests.

SECTION 4 VERIFICATION OF PERFORMANCE

4.1 QUALITY ASSURANCE

The verification tests were conducted in accordance with an approved Test/Quality Assurance (QA) Plan.² The EPA Quality Manager conducted an independent assessment of the test laboratory in August 1999 and found that the test laboratory was being operated as specified in the Test/QA Plan. Additionally, APCT Quality Assurance staff have reviewed the results of this test and have found that the results meet data quality objectives in the Test/QA Plan. Certificates of Calibration for the optical particle counter and the airflow reference devices are provided in Appendix B.

4.2 RESULTS

Tables 6 and 7 and Figures 2 through 5 summarize the fractional filtration efficiency measurements for the solid- and liquid-phase tests. Upstream and downstream particle count data for each test are provided in Appendix C.

The initial (new condition) pressure drop across each test arrestor at the 120 fpm (0.61 m/s) test velocity [for a flowrate of 480 cfm (0.23 m³/s)] is shown in Table 8. The pressure drop across the tested arrestors ranged from 0.13 to 0.16 in. H₂O (32 to 40 Pa) for each of the six arrestors tested.

Tables 1-4 (page iv) present the filtration efficiency requirements of the Aerospace NESHAP and the corresponding efficiencies measured for the tested arrestor system. The test results indicate that the tested arrestor met the requirements listed in Tables 1 and 2 for existing sources but not those listed in Tables 3 and 4 for new sources.

4.3 LIMITATIONS AND APPLICATIONS

This verification report addresses two aspects of paint overspray arrestor performance: filtration efficiency and pressure drop. Users of this technology may wish to consider other performance parameters such as service life and cost when selecting a paint overspray arrestor for their use.

In accordance with the generic verification protocol, this Verification Statement is applicable to paint overspray arrestors manufactured between the publication date of the Verification Statement and 12 months thereafter.

As stated in Section 1.3 of Method 319³, "for a paint arrestor system or subsystem which has been tested by this method, adding additional filtration devices to the system or subsystem shall be assumed to result in an efficiency of at least that of the original system without additional testing."

SECTION 5 REFERENCES

1. Generic Verification Protocol for Paint Overspray Arrestors, Research Triangle Institute, Research Triangle Park, NC, August 1999.
2. Test/QA Plan for Paint Overspray Arrestors, Research Triangle Institute, Research Triangle Park, NC, February 1999.
3. Method 319: Determination of Filtration Efficiency for Paint Overspray Arrestors. *Code of Federal Regulations*, Appendix A to 40 CFR Part 63.
4. National Emission Standards for Hazardous Air Pollutants for Aerospace Manufacturing and Rework Facilities. *Code of Federal Regulations*, Title 40, Part 63, Subpart GG (40 CFR 63.741).

TABLE 6. SUMMARY OF SOLID-PHASE TEST RESULTS

		Filtration Efficiency (%) at Indicated Size Range														
		1	2	3	4	5	6	7	8	9	10	11	12	13	14	15
OPC Channel Number																
Min. Diam. (um)		0.45	0.59	0.73	0.80	1.02	1.44	1.86	2.28	2.85	3.13	4.25	5.66	7.07	7.77	9.88
Max. Diam. (um)		0.59	0.73	0.80	1.02	1.44	1.86	2.28	2.85	3.13	4.25	5.66	7.07	7.77	9.88	14.10
Geo. Mean Diam (um)		0.52	0.66	0.77	0.90	1.21	1.64	2.06	2.55	2.98	3.65	4.91	6.33	7.41	8.76	11.81
ATI OSM 200 System																
Run #1	09079904	2	2	4	5	6	10	14	25	40	56	81	94	98	99	100
Run #2	09079906	3	1	3	3	5	7	14	26	40	56	79	93	96	98	100
Run #3	09079908	0	0	2	1	3	7	14	29	47	62	86	96	99	99	100
Average		2	1	3	3	5	8	14	27	42	58	82	94	98	98	100
Interpolated Efficiency Values (%) for Existing Source Criteria:																
2.60 um (> 10% required):																
5.00 um (> 50% required):																
8.10 um (> 90% required):																
Interpolated Efficiency Values (%) for New Source Criteria:																
0.70 um (> 75% required):																
1.10 um (> 85% required):																
2.50 um (> 95% required):																
HEPA Filter Control Test (applicable to both solid and liquid phase conditions)																
Run #1	08319904	100	100	100	100	100	100	100	100	100	100	100	100	100	100	100
Reference Filter QA Test																
Current	09079902	1	1	2	2	1	4	4	8	13	22	41	64	80	85	91
Baseline	08279902	1	1	0	1	1	4	4	7	14	19	42	68	81	86	92
Difference		0	1	1	1	0	0	0	1	-1	2	-1	-3	-1	-1	-1
Acceptable (<10)		yes	yes	yes	yes	yes	yes	yes	yes	yes	yes	yes	yes	yes	yes	yes
"No Filter" Control Tests																
		Penetration For Each Size Range														
Run #1	09079903	1.02	1.02	1.02	1.03	1.02	1.02	1.02	1.00	1.00	1.00	0.96	0.90	0.83	0.84	0.82
Run #2	09079905	1.01	1.00	0.99	0.99	1.00	0.99	0.99	0.99	0.98	0.99	0.95	0.88	0.80	0.81	0.81
Run #3	09079907	1.00	1.00	0.99	0.98	0.99	0.99	0.98	0.99	0.99	0.98	0.93	0.87	0.86	0.84	0.82

TABLE 7. SUMMARY OF LIQUID- PHASE TEST RESULTS

		Filtration Efficiency (%) at Indicated Size Range															
OPC Channel Number		1	2	3	4	5	6	7	8	9	10	11	12	13	14	15	
Min. Diam. (um)		0.28	0.37	0.47	0.52	0.66	0.94	1.22	1.51	1.88	2.07	2.83	3.77	4.71	5.18	6.60	
Max. Diam. (um)		0.37	0.47	0.52	0.66	0.94	1.22	1.51	1.88	2.07	2.83	3.77	4.71	5.18	6.60	9.43	
Geo. Mean Diam (um)		0.32	0.418	0.49	0.58	0.78	1.07	1.36	1.68	1.97	2.42	3.26	4.21	4.94	5.85	7.89	
ATI OSM 200 System																	
Run #1	09089902	1	3	3	2	2	4	7	15	25	40	68	90	97	99	100	
Run #2	09089904	1	2	2	1	4	5	7	15	25	40	68	91	98	99	100	
Run #3	09089907	1	2	2	2	2	4	7	12	24	33	60	85	94	96	99	
Average		1	3	2	2	3	4	7	14	25	38	65	88	96	98	100	
Interpolated Efficiency Values (%) for Existing Source Criteria:																	
2.20 um (> 10% required):		31															
4.10 um (> 50% required):		86															
5.70 um (> 90% required):		98															
Interpolated Efficiency Values (%) for New Source Criteria:																	
0.42 um (> 65% required):		2															
1.00 um (> 80% required):		4															
2.00 um (> 95% required):		25															
"No Filter" Control Tests																	
		Penetration For Each Size Range															
Run #1	09089901	1.01	1.01	1.01	1.01	1.01	1.00	1.01	1.01	1.02	1.02	1.01	1.00	0.93	0.86	0.90	0.63
Run #2	09089903	1.01	1.01	1.00	1.00	1.01	1.01	1.01	1.01	1.01	1.01	1.01	1.00	0.94	0.89	0.84	0.75
Run #3	09089905	1.01	1.01	1.01	1.01	1.01	1.01	1.01	1.01	1.01	1.04	1.01	1.00	0.94	0.89	0.83	0.69

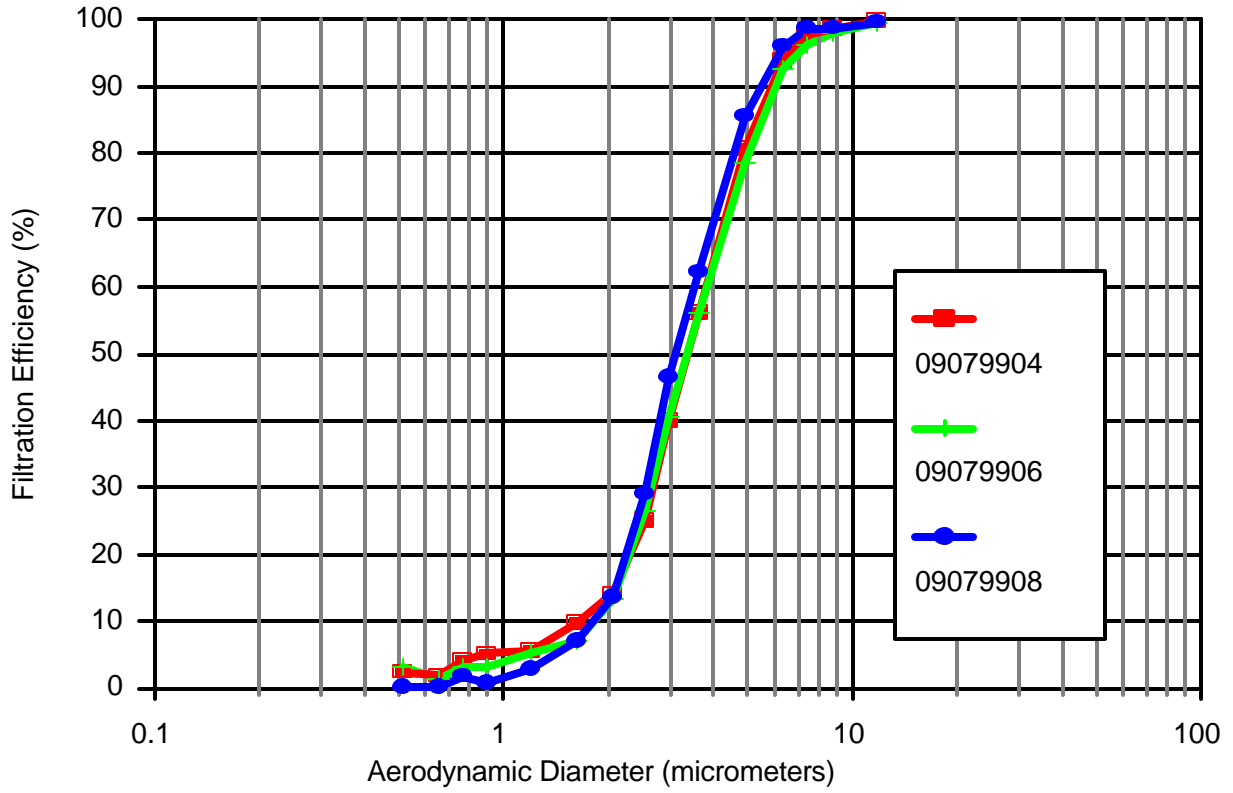

Figure 2. Triplicate solid-phase particle removal efficiency curves for the ATI OSM 200 System paint overspray arrestor.

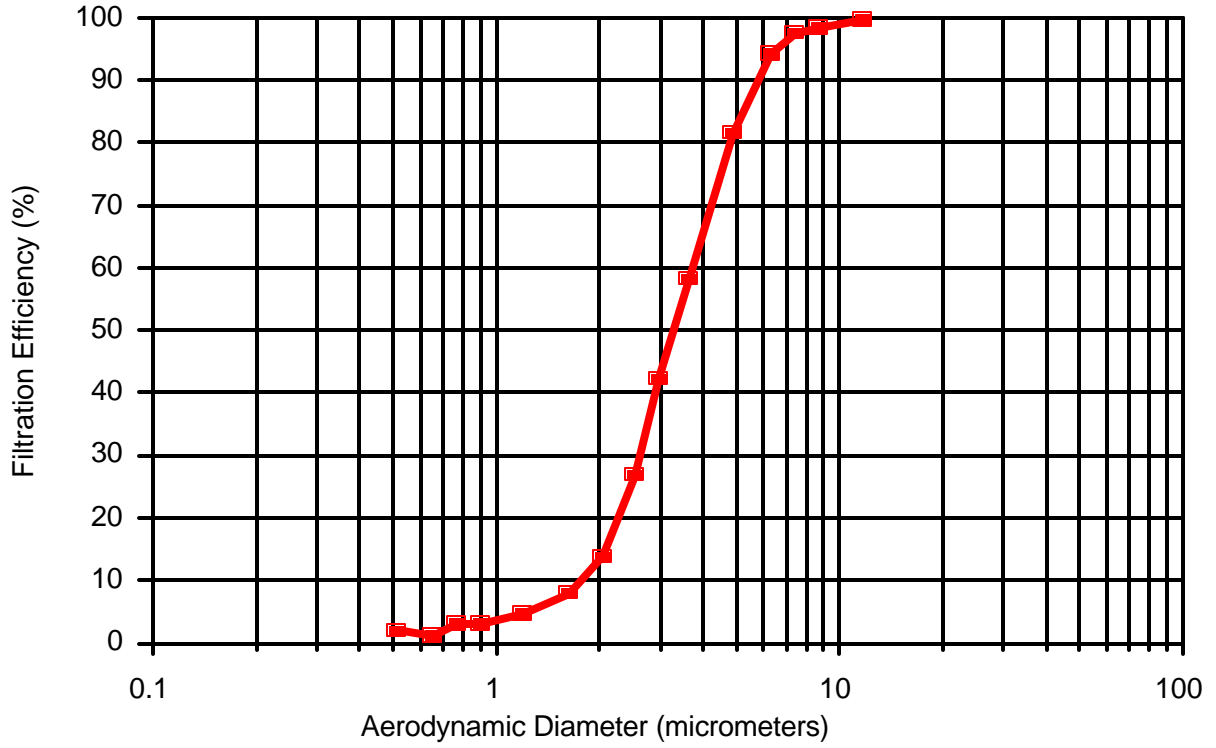

Figure 3. Average of the solid-phase particle removal efficiency curves for the ATI OSM 200 System paint overspray arrestor.

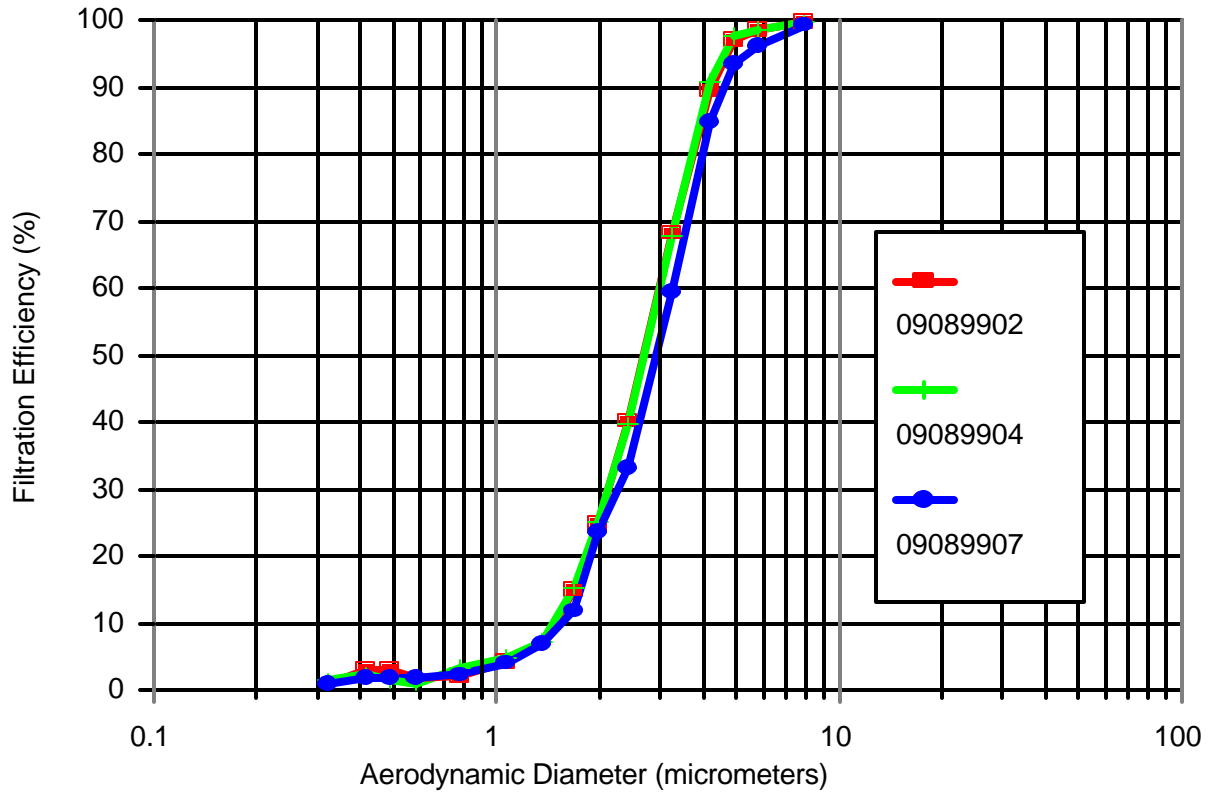

Figure 4. Triplicate liquid-phase particle removal efficiency curves for the ATI OSM 200 System paint overspray arrestor.

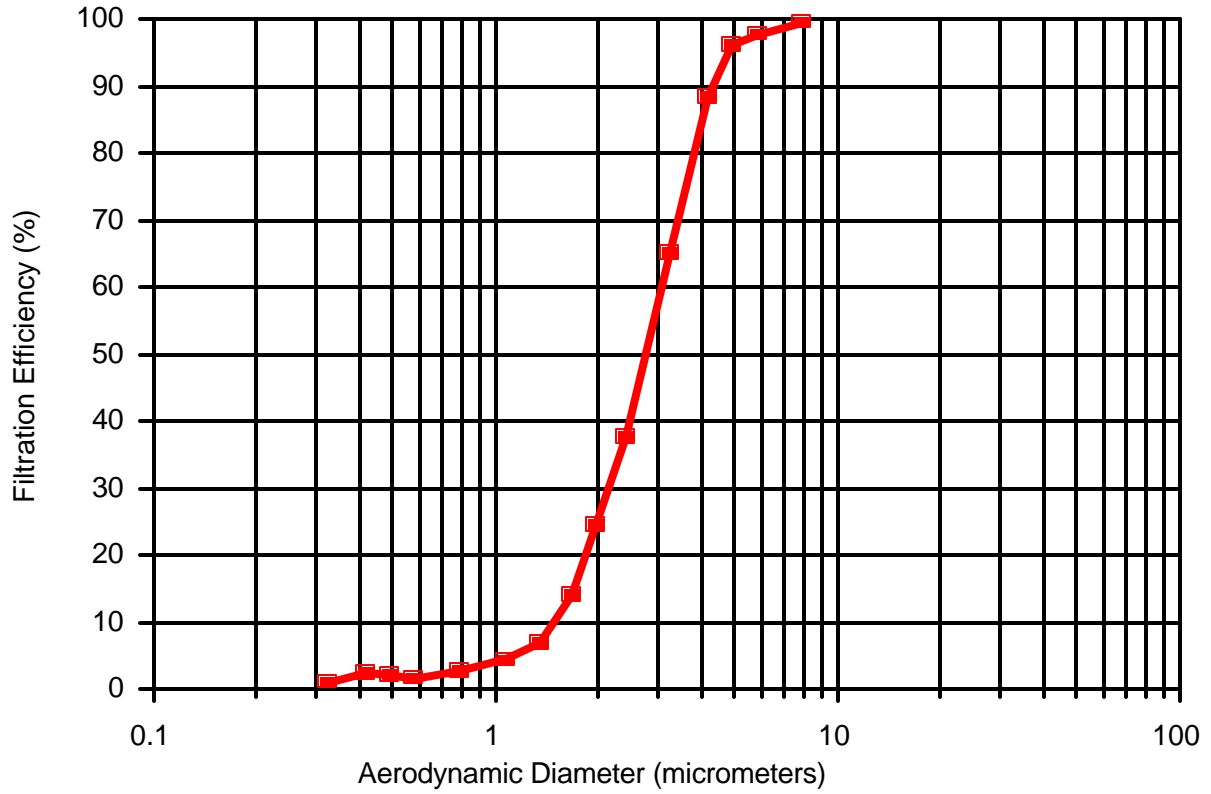

Figure 5. Average of the liquid-phase particle removal efficiency curves for the ATI OSM 200 System paint overspray arrestor.

TABLE 8.
SUMMARY OF PRESSURE DROP MEASUREMENTS

Test No.	Initial Pressure Drop (inch H ₂ O)	Initial Pressure Drop (Pa)
09079904	0.13	32
09079906	0.13	32
09079908	0.16	40
09089902	0.14	35
09089904	0.13	32
09089907	0.13	32

Appendix A

DESCRIPTION OF THE TEST RIG AND METHODOLOGY

TEST DUCT

The tests were conducted in RTI's air cleaner test facility (Figure A-1). The test rig's ducting was primarily of 24 x 24 in. (0.61 x 0.61m) cross section and made of 14-gauge stainless steel. The blower is rated at 15 hp (11 kW) with a flow capacity of 3000 cfm (1.4 m³/s) at 13 in. H₂O (3200 Pa). The inlet and outlet filter banks consist of two 24 x 24 x 2 in. (0.61 x 0.61 x 0.05 m) prefilters and two 24 x 24 x 12 in. (0.61 x 0.61 x 0.30 m) high efficiency particulate air (HEPA) filters rated at 2000 cfm (0.9 m³/s) each. The system operates at positive pressure to minimize infiltration of room air.

To mix the test aerosol with the air stream, an orifice plate and mixing baffle were located immediately downstream of the aerosol injection point and upstream of the test arrestor. An identical orifice plate and mixing baffle were added after the 180° bend. The latter downstream orifice served two purposes. It straightened out the flow after going around the bend, and it mixed any aerosol that penetrated the air cleaning device. Mixing the penetrating aerosol with the air stream is necessary to obtain a representative downstream aerosol measurement.

AIRFLOW

Airflow was measured with a 4.00 in. (0.102 m) ID American Society of Mechanical Engineers (ASME) flow nozzle. The nominal velocity through the arrestor was computed by dividing the volumetric flow by the nominal face area of the device. Airflow was manually controlled by a 14 in. (0.36 m) diameter butterfly valve.

OPTICAL PARTICLE COUNTER (OPC)

Aerosol concentrations were measured with a Climet Instruments Model 226 OPC. This OPC uses a white-light illumination source and has a wide collection angle for the scattered light. The OPC's sampling rate was 0.25 cfm (0.00012 m³/s).

The output of the OPC was input to a Climet Instruments Model 8040 multichannel analyzer equipped with Model 05872005 and 05872006 input boards. These boards provide 16 sizing channels covering the range from 0.3 to 10 µm. The 8040 was also equipped with a Model CI-298 sequential interface board. This interface provides a contact closure at the end of each sample and also provides a 15-sec delay in particle counting after each sample. The contact closure was used to control the operation of electromechanical valve actuators in the upstream and downstream sample lines. The 15-sec delay allows time for the new sample to be acquired.

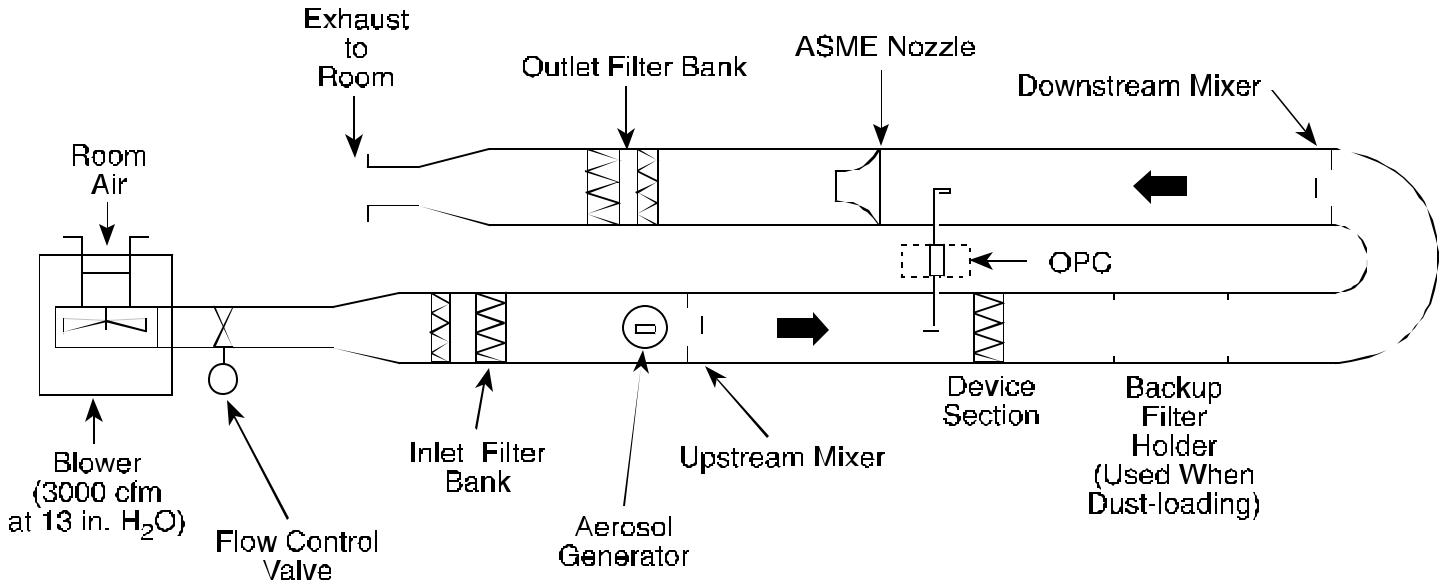

Overview of Test Duct Configuration (Top View)

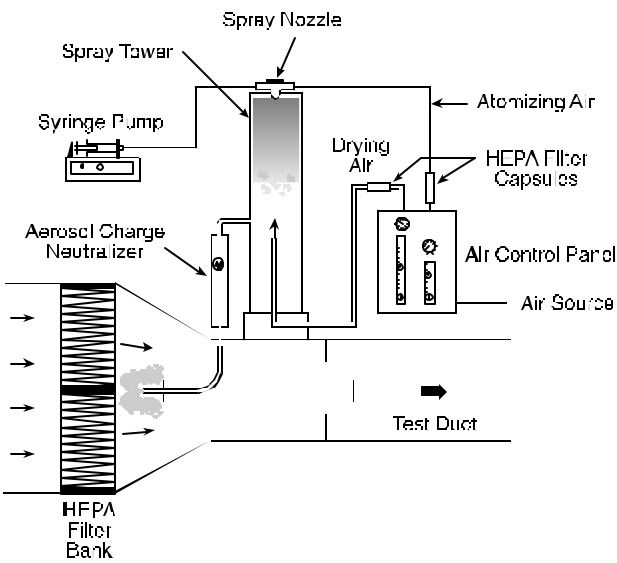

Aerosol Generation System (Side View)

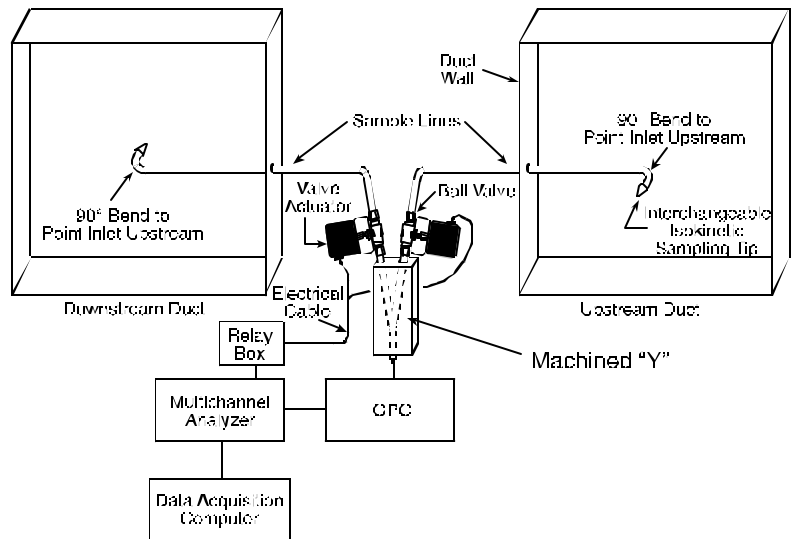

Aerosol Sampling System (End View)

Figure A-1. Schematic illustration of the fractional efficiency test rig.

AEROSOL GENERATION

Two types of challenge aerosols were used: liquid- and solid-phase. The selection of liquid- or solid-phase challenge aerosol particles is important because for some types of paint arrestors significantly different filtration efficiencies will be achieved depending upon the phase of the challenge aerosol particles. (This is due to particle "bounce" associated with solid-phase particles.) The liquid-phase challenge aerosol is oleic acid, a non-toxic, low-volatility liquid. The solid-phase aerosol is potassium chloride (KCl) generated from an aqueous solution. KCl was selected as the solid-phase aerosol because of its relatively high water solubility, high deliquescence humidity (85% relative humidity), known crystalline structure (facilitates complete drying), and low toxicity. The KCl solution was prepared by combining 0.66 lb (300 g) of KCl with 0.035 ft³ (1 L) of distilled water. Both oleic acid and KCl are compatible with accurate measurement by the optical particle counter.

The oleic acid or the KCl solution was nebulized using a two-fluid (air and liquid) air atomizing nozzle (Spray Systems 1/4 J siphon spray nozzle) as illustrated in Figure A-1 (aerosol generation system). The nozzle was positioned at the top of a 12 in. (0.30 m) diameter, 51 in. (1.3 m) tall transparent acrylic spray tower. The tower served two purposes. It allowed the salt droplets to dry by providing an approximate 40 sec mean residence time, and it allowed larger-sized particles (of either KCl or oleic acid) to fall out of the aerosol. After generation, the aerosol passed through a TSI Model 3054 aerosol neutralizer (Kr-85 radioactive source) to neutralize any electrostatic charge on the aerosol (electrostatic charging is an unavoidable consequence of most aerosol-generation methods).

The KCl solution or oleic acid was fed to the atomizing nozzle at 1.2 mL/min by means of a pump. Varying the operating air pressure of the generator allows control of the output aerosol concentration.

AEROSOL SAMPLING SYSTEM

The aerosol sampling lines were 0.55 in. (14 mm) ID stainless steel lines and used gradual bends [radius of curvature = 2.25 in. (57 mm)] when needed. These dimensions were chosen to minimize particle losses in the sample lines. A custom-made "Y" fitting connected the upstream and downstream lines to the OPC. The two branches of the "Y" merged gradually to minimize particle loss in the intersection of the "Y" due to centrifugal or impaction forces.

Immediately above the "Y," electrically actuated ball valves were installed in each branch (Parker Model EA Electro-Mechanical Valve Actuator). The opening and closing of the valves were automatically controlled by the OPC's sequential sampling interface board. The valves take approximately 2 sec to complete an opening or closing maneuver.

Isokinetic sampling nozzles of the appropriate entrance diameter were placed on the ends of the sample probes to maintain isokinetic sampling for all the test flow rates.

TEST PROCEDURES

The aerosol penetration of the test device was calculated from the average of 10 upstream and 10 downstream samples taken sequentially (i.e., one upstream, one downstream, one upstream, one downstream, . . . until 10 each were obtained). This sequential sampling scheme was selected to minimize the effect of aerosol generator variability. Each sample was 2 minutes in duration. The sampling also included background upstream and downstream measurements at the beginning and end of each test. The test sequence was as follows:

1. Warm up OPC and install proper sample tips for isokinetic sampling.
2. Install air cleaner test device and bring test duct to desired flow rate.
3. With the aerosol generator off, obtain one measurement each of the upstream and downstream background particle counts.
4. Turn on the aerosol generator and allow it to run for a minimum of 10 minutes to stabilize.
5. After the stabilization period, obtain 10 upstream and 10 downstream particle counts using a repeated upstream-downstream sampling sequence until 10 each are obtained.
6. Turn off the aerosol generator. Wait 10 minutes, then obtain one additional upstream and downstream background measurement.

CONTROL TESTS

In addition to evaluating the test arrestor, 0 and 100% penetration control tests and a reference filter control test were conducted to ensure that reliable measurements are obtained. The 100% penetration test was a relatively stringent test of the adequacy of the overall duct, sampling, measurement, and aerosol generation system. These tests were performed as normal penetration tests except that the paint arrestor was not used. A perfect system would yield a measured penetration of 1 at all particle sizes. Deviations from 1 can occur due to particle losses in the duct, differences in the degree of aerosol uniformity (i.e., mixing) at the upstream and downstream probes, and differences in particle-transport efficiency in the upstream and downstream sampling lines. Results from the 100% penetration tests were used during data analysis to correct penetration measurements obtained during the arrestor tests.

The 0% penetration test was performed by using a HEPA filter rather than a paint arrestor. This test confirmed the adequacy of the instrument response time and sample line lag. The 0% penetration test was performed on a monthly basis.

The reference filter control test consisted of performing a solid-phase efficiency test on the same filter during each ETV test. The reference filter data from each test were compared to the original, baseline reference filter data to determine if there was any substantial change in the test system between the tests.

DATA ANALYSIS

Nomenclature

- P = Penetration corrected for P_{100} value
- D = Downstream particle count
- D_b = Downstream background count
- U = Upstream particle count
- U_b = Upstream background count
- P_{100} = 100% penetration value determined from the control tests
- Overbar: denotes arithmetic mean of quantity

Analysis of each test involves the following quantities:

- ! P_{100} value for each sizing channel from the blank (no-filter) test,
- ! 2 upstream background values,
- ! 2 downstream background values,
- ! 10 upstream values with aerosol generator on, and
- ! 10 downstream values with aerosol generator on.

Using the values associated with each sizing channel, the penetration associated with each particle sizing channel was calculated as:

$$P = \{(\bar{D} - \bar{D}_b) / (\bar{U} - \bar{U}_b)\} / P_{100} .$$

Filtration efficiency was then calculated as:

$$\text{Filtration Efficiency (\%)} = 100 (1 - P).$$

DEFINITION OF PARTICLE DIAMETER

Over the 0.3 to 10 μm diameter size range, the "aerodynamic" particle diameter is often of more significance than the physical diameter (as measured by the OPC) relative to aerosol filtration and aerosol deposition within the human respiratory tract. The aerodynamic diameter (D_{Aero}) is related to the physical diameter (D_{Physical}) by:

$$D_{\text{Aero}} = D_{\text{Physical}} \sqrt{\frac{\rho_{\text{Particle}}}{\rho_o} \frac{CCF_{\text{Physical}}}{CCF_{\text{Aero}}} \frac{1}{X}}$$

where

ρ_{Particle} is the density of the particle in g/cm^3 .

ρ_o is unit density of 1 g/cm^3 .

CCF_{Physical} is the Cunningham Correction Factor at D_{Physical} .

CCF_{Aero} is the Cunningham Correction Factor at D_{Aero} .

X is the dynamic shape factor.

Note: due to the interdependence of D_{aero} and CCF_{Aero} , the equation is solved iteratively.

For oleic acid droplets having a density of 0.89 g/cm^3 and being spherical ($X = 1$), the aerodynamic diameter will be about 6% smaller than the measured diameter.

KCl has a density of 1.98 g/cm^3 . The KCl particles form from the evaporation of aqueous solution droplets. Because KCl has an inherent cubic crystalline structure, it is expected that the KCl particles will be cubic or relatively compact cubic clusters; however, their actual shape, or range of shapes, is unknown. Because the shape factor is unknown, the shape factor for KCl is assigned a value of 1 and the diameter is termed the "nominal" aerodynamic diameter.

The aerodynamic diameters associated with the 15 OPC sizing channels are tabulated in Table A-1 for oleic acid and KCl. Also listed is the physical diameter size range for each channel based on the manufacturer's calibration curve using monodisperse polystyrene latex (PSL) spheres.

**Table A-1. Physical and Aerodynamic Sizing Channels
for the Calibration and Test Aerosols**

	Particle Diameter Size Range (μm)*		
	PSL	OLEIC ACID	KCl
OPC Channel Number	Physical Diameter	Aerodynamic Diameter	Nominal Aerodynamic Diameter
1	0.3 - 0.4	0.28 - 0.37	0.45 - 0.59
2	0.4 - 0.5	0.37 - 0.47	0.59 - 0.73
3	0.5 - 0.55	0.47 - 0.52	0.73 - 0.80
4	0.55 - 0.7	0.52 - 0.66	0.80 - 1.02
5	0.7 - 1.0	0.66 - 0.94	1.02 - 1.44
6	1.0 - 1.3	0.94 - 1.22	1.44 - 1.86
7	1.3 - 1.6	1.22 - 1.51	1.86 - 2.28
8	1.6 - 2	1.51 - 1.88	2.28 - 2.85
9	2 - 2.2	1.88 - 2.07	2.85 - 3.13
10	2.2 - 3	2.07 - 2.83	3.13 - 4.25
11	3 - 4	2.83 - 3.77	4.25 - 5.66
12	4 - 5	3.77 - 4.71	5.66 - 7.07
13	5 - 5.5	4.71 - 5.18	7.07 - 7.77
14	5.5 - 7	5.18 - 6.60	7.77 - 9.88
15	7 - 10	6.60 - 9.43	9.88 - 14.1

*The particle diameter size ranges are defined as greater than the indicated lower limit and less than or equal to the indicated upper limit.

APPENDIX B
Certificates of Calibration

Certificate of Traceability

8500D-II THERMOANEMOMETER

Model No. 8500D-II Serial No. 3810 Part No. 634493200

Certificate Number: 1946 Date: 26-Oct-88 P.O. 00329 Order/RMA: 404638
 Customer Number:

*Calibration Standards Information
 The following standards and equipment were used as references for this calibration.*

Tested By	Date Tested	Insl. No.	Cal. Due	NIST Test Numbers
LOZADA	10/23/88	747	4/9/00	2593-4; 257802; 259800; 256692; 260222; 811255682;
		746	4/9/00	811255622; 811260176;
		922	6/8/00	536255547-93
		831	11/08/88	811257078 ; 247770 ; 263606 ; 811255674 ; 253639 ; USN22783C ; Chem Const. ; 25-4227 ; 811254736 ; 811251562 ; 251971 ; 811251741 ; 811253662 ; 811256216 ; 811822 ;
		657	6/8/00	836259947-98
		794	3/13/90	
		688	2/21/00	811266766 ; 251971 ; 811255004-80 ; 811257773 ; 256216 ;
		399	11/12/88	P-8531A ; P-8531B ; 38126 ; 251960 ; 2563002 ;
		325	2-4-99	P-8531A ; P-8531B ; 38126 ; 254160 ; 2590009 ;
		313	11/12/88	P-8531A ; P-8531B ; 38126 ; 254160 ; 2563002 ;
		301	12/11/86	835257126-96 ;

Alnor Instrument Company hereby certifies that the above designated equipment was found to meet or exceed manufacturing specifications. Their calibration is traceable to the National Institute of Standards and Technology (NIST) or national physical constants. The policies and procedures used comply with ML-STD-4562A. This certificate shall not be reproduced except in full, without the written consent of Alnor.

Reviewed by: 
 Date: 26-Oct-88



Alnor Instrument Company
 7555 W. Linder Avenue, Sicak, IL 60077
 Tel. 847-677-3500 Fax. 847-677-3539



FILE NO. 040FB:001-19
PAGE 1 OF 1

LETTER OF CERTIFICATION
LAMINAR FLOW ELEMENT

CUSTOMER NAME: RESEARCH TRIANGLE INST
 CUSTOMER ORDER NUMBER: 00161
 MERIAM ORDER NUMBER: 772900

Meriam Instrument certifies that the completed LFE unit has been calibrated and correlated at several points of flow rate using a Meriam Standard, which is controlled per the calibration system requirements of ANSI Z540-1 and traceable to the National Institute of Standards and Technology. The collective uncertainty of the measurement standards has a 1:1 ratio to the acceptable tolerance for the flow rate being calibrated.

The total rss uncertainty of the completed laminar flow unit is +/- .72 % of reading.

CUSTOMER ID NO.: 013716

MODEL NO.: 50MH10-8 SERIAL NO.: 758860-K1

FLOW CURVE/TABLE NO.: 30624

DATE OF CALIBRATION 11-11-1998 BY GEORGE ROBOTKAY

AS RECEIVED CONDITION: In Tolerance Out of Tolerance NA

AS LEFT CONDITION : In Tolerance Out of Tolerance NA

CALIBRATION INTERVAL: TO BE DETERMINED BY CUSTOMER BASED ON USAGE OF LFE.

FLOW STANDARD SERIAL NO.	DATE OF LAST CAL	DATE OF NEXT CAL
WMMC2-6	JAN 1998	JAN 1999

The LFE unit listed hereon has been successfully calibrated in accordance with Meriam Instrument Procedure A-35822.

Michael V. ...
 QUALITY ASSURANCE INSPECTOR
 MERIAM INSTRUMENT

Jack Weigand
 QUALITY ASSURANCE MANAGER
 MERIAM INSTRUMENT

US EPA ARCHIVE DOCUMENT

CLIMET INSTRUMENTS COMPANY

1320 WEST COLTON AVE., REDLANDS, CA 92374 • PHONE: (909) 793-2788 • FAX: (909) 793-1738

CERTIFICATE OF CALIBRATION**INSTRUMENT CALIBRATED**MODEL: 226 aerosol particle counter, S/N 61882CONTROL NUMBER: LCS23102DATE CALIBRATED: 8/19/99 NEXT CALIBRATION: 2/19/2000RECOMMENDED CALIBRATION INTERVAL: 6 monthsL. Sparks
CALIBRATED BYJohn R. Griston
APPROVED BY**TRACEABILITY STATEMENT**

This instrument has been calibrated in accordance with ISO 10012-1/ANSI Z540-1 (which replaces MIL-STD-45662A) and relevant portions of Federal Standards 209, ASTM F-50, F322, and F328.

Temperature and Relative Humidity are not controlled during calibration because of the wide operating range of the instrument. The operating limits of this instrument are:

TEMPERATURE: 30°F TO 122°F
HUMIDITY: 0-100%, non-condensing

All test equipment used in the calibration of Climet Instruments' products is calibrated at six-month intervals by an outside calibration service. Calibration certificates for each piece of test equipment are on file at Climet; copies will be supplied if requested.

Calibration traceability to a National Measurement Standard (NMS) is established by using mono-disperse latex spheres as a calibration standard. These spheres are sized by methods traceable, by lot number, to the National Institute of Science and Technology.

APPENDIX C
Fractional Efficiency Data Sheets

Key to notation used in the following tables:

Diam.:	Particle Diameter (µm)
Geo.:	Geometric
U. Bckgrnd:	The upstream background particle counts measured with the aerosol generator off.
Upstream:	The upstream particle counts measured with the aerosol generator on.
D. Bckgrnd:	The downstream background particle counts measured with the aerosol generator off.
Downstream:	The downstream particle counts measured with the aerosol generator on.
Meas. Penetration:	The penetration computed as:

$$\text{Meas. Penetration} = \frac{(\text{Downstream} \& \text{D. Bckgrnd})}{(\text{Upstream} \& \text{U. Bckgrnd})}$$

P100 Correction Values:	Penetration values measured with no filter in the test section. These values are used to correct subsequent penetration measurements for particle losses within the test duct and sampling system.
Corrected Penetration:	The measured penetration corrected by the P100 values:

$$\text{Corrected Penetration} = \frac{\text{Meas. Penetration}}{\text{P100 Correction Values}}$$

Corrected Efficiency (%):	100 x (1 - Corrected Penetration)
DQO	Data Quality Objective

Test No. 09039909
 No Filter
 Solid-Phase

Particle Counts per Indicated OPC Channel (1-Minute Samples @ 7.1 L/min)

OPC Channel Number	1	2	3	4	5	6	7	8	9	10	11	12	13	14	15
Min. Diam. (um)	0.45	0.59	0.73	0.80	1.02	1.44	1.86	2.28	2.85	3.13	4.25	5.66	7.07	7.77	9.88
Max. Diam. (um)	0.59	0.73	0.80	1.02	1.44	1.86	2.28	2.85	3.13	4.25	5.66	7.07	7.77	9.88	14.10
Geo. Mean Diam (um)	0.52	0.66	0.77	0.90	1.21	1.64	2.06	2.55	2.98	3.65	4.91	6.33	7.41	8.76	11.81

ENTER DATA BELOW

U. Bckgrnd	1 01 09-03-1999 15:34:57 01:00	0	0	0	0	0	0	0	0	0	0	0	0	0	0	
Upstream	1 01 09-03-1999 15:42:41 01:00	10490	15180	4908	8921	13680	8083	10690	10570	2496	5616	3134	1013	162	260	177
Upstream	1 01 09-03-1999 15:45:11 01:00	10110	15320	4993	8836	13690	8130	10470	10820	2612	5465	3151	1018	168	261	159
Upstream	1 01 09-03-1999 15:47:41 01:00	9983	14980	4901	8768	13450	8170	10290	10330	2567	5501	3135	999	140	240	142
Upstream	1 01 09-03-1999 15:50:11 01:00	9916	14960	4879	8810	13370	8061	10500	10460	2531	5545	3070	995	163	227	177
Upstream	1 01 09-03-1999 15:52:41 01:00	10280	15320	4869	8935	13500	8141	10310	10600	2581	5632	3102	1029	159	235	155
Upstream	1 01 09-03-1999 15:55:11 01:00	10020	14830	4818	8709	13400	8114	10390	10470	2581	5352	3128	987	150	234	147
Upstream	1 01 09-03-1999 15:57:41 01:00	9589	14440	4610	8534	13400	7958	10090	10140	2614	5341	3053	952	157	243	142
Upstream	1 01 09-03-1999 16:00:11 01:00	9885	14920	4757	8822	13280	7973	10210	10520	2719	5588	3223	1037	195	282	194
Upstream	1 01 09-03-1999 16:02:41 01:00	9897	14820	4853	9005	14040	8199	10750	10820	2809	5817	3348	1105	172	261	168
Upstream	1 01 09-03-1999 16:05:11 01:00	9537	14220	4623	8197	12940	7621	9792	10030	2525	5461	3177	975	161	228	176
U. Bckgrnd	1 01 09-03-1999 16:16:33 01:00	1	0	0	0	0	1	1	0	0	0	0	0	0	0	

ENTER DATA BELOW

D. Bckgrnd	2 01 09-03-1999 15:36:12 01:00	2	0	0	0	0	0	0	0	0	0	0	0	0	0	
Downstream	2 01 09-03-1999 15:43:56 01:00	10240	15140	5017	8998	13590	8351	10270	10520	2641	5462	2917	854	135	202	126
Downstream	2 01 09-03-1999 15:46:26 01:00	9996	14980	4913	8870	13540	8162	10500	10450	2597	5476	2969	900	145	205	119
Downstream	2 01 09-03-1999 15:48:56 01:00	10180	15260	4892	8905	13520	8065	10370	10570	2520	5588	3021	837	127	201	129
Downstream	2 01 09-03-1999 15:51:26 01:00	10050	15410	4888	9079	13890	8244	10210	10560	2597	5574	3077	820	141	181	148
Downstream	2 01 09-03-1999 15:53:56 01:00	10020	15220	4710	8865	13530	8086	10380	10200	2507	5551	2964	948	122	200	112
Downstream	2 01 09-03-1999 15:56:26 01:00	10060	15040	4809	8934	13840	8102	10530	10100	2495	5312	2917	826	114	180	115
Downstream	2 01 09-03-1999 15:58:56 01:00	10000	15150	4905	8733	13740	8182	10530	10730	2796	5809	3273	977	142	232	132
Downstream	2 01 09-03-1999 16:01:26 01:00	9895	14860	4756	8752	13610	8065	10320	10560	2564	5644	3169	896	132	234	130
Downstream	2 01 09-03-1999 16:03:56 01:00	10000	14990	4740	8756	13710	8149	10350	10760	2809	5642	3246	921	147	238	126
Downstream	2 01 09-03-1999 16:06:26 01:00	9720	14580	4733	8574	13290	7746	10130	10410	2656	5534	3129	915	131	178	145
D. Bckgrnd	2 01 09-03-1999 16:17:48 01:00	0	0	0	0	0	0	0	0	0	0	0	0	0	0	

Meas. Penetration	1.00	1.01	1.00	1.01	1.01	1.01	1.00	1.00	1.00	1.01	1.00	0.97	0.88	0.82	0.83	0.78
P100 correction values	1.00	1.00	1.00	1.00	1.00	1.00	1.00	1.00	1.00	1.00	1.00	1.00	1.00	1.00	1.00	1.00
Corrected Penetration	1.00	1.01	1.00	1.01	1.01	1.01	1.00	1.00	1.00	1.01	1.00	0.97	0.88	0.82	0.83	0.78
Corrected Efficiency (%)	0	-1	0	-1	-1	-1	0	0	-1	0	3	12	18	17	22	

Data Acceptance Criteria:

Total Challenge Counts for Each Channel:	99707	148990	48211	87537	134750	80450	103492	104760	26035	55318	31521	10110	1627	2471	1637
Data Quality Objective:	> 500	> 500	> 500	> 500	> 500	> 500	> 500	> 500	> 500	> 500	> 500	> 500	> 500	> 500	> 500
Does this meet DQO:	Yes	Yes	Yes	Yes	Yes	Yes	Yes	Yes	Yes	Yes	Yes	Yes	Yes	Yes	Yes

Standard Deviation of Penetration for Each Channel :	0.03	0.03	0.03	0.03	0.03	0.03	0.03	0.03	0.06	0.04	0.05	0.06	0.10	0.11	0.11
Data Quality Objective:	<0.10	<0.10	<0.10	<0.10	<0.10	<0.10	<0.10	<0.10	<0.10	<0.30	<0.30	<0.30	<0.30	<0.30	<0.30
Does this meet DQO:	Yes	Yes	Yes	Yes	Yes	Yes	Yes	Yes	Yes	Yes	Yes	Yes	Yes	Yes	Yes

Maximum observed particle concentration (#/cc):	17.3
Data Quality Objective: max. allowable conc. (#/cc):	< 23
Does this meet the DQO:	Yes, (applies to all channels)

US EPA ARCHIVE DOCUMENT

Test No. 09079902
Reference Filter
Solid-Phase

Particle Counts per Indicated OPC Channel (1-Minute Samples @ 7.1 L/min)

OPC Channel Number	1	2	3	4	5	6	7	8	9	10	11	12	13	14	15
Min. Diam. (um)	0.45	0.59	0.73	0.80	1.02	1.44	1.86	2.28	2.85	3.13	4.25	5.66	7.07	7.77	9.88
Max. Diam. (um)	0.59	0.73	0.80	1.02	1.44	1.86	2.28	2.85	3.13	4.25	5.66	7.07	7.77	9.88	14.10
Geo. Mean Diam (um)	0.52	0.66	0.77	0.90	1.21	1.64	2.06	2.55	2.98	3.65	4.91	6.33	7.41	8.76	11.81

ENTER DATA BELOW

U. Bckgrnd	1 01 09-07-1999 10:15:31 01:00	0	0	0	0	0	0	0	0	0	0	0	0	0	0	
Upstream	1 01 09-07-1999 10:27:10 01:00	9690	14600	4642	8686	13080	7937	10360	10930	2654	5968	3578	1303	213	358	255
Upstream	1 01 09-07-1999 10:29:40 01:00	9742	14650	4644	8528	13130	7788	10320	10640	2736	6007	3509	1234	202	366	229
Upstream	1 01 09-07-1999 10:32:10 01:00	10170	15060	4878	8722	13310	8156	10720	11380	2729	5988	3566	1324	209	327	266
Upstream	1 01 09-07-1999 10:34:40 01:00	9396	13980	4526	8155	12770	7754	9921	10490	2637	5841	3494	1233	203	331	226
Upstream	1 01 09-07-1999 10:37:10 01:00	8794	13010	4194	7699	11460	6937	9018	9253	2256	4991	3011	1040	172	315	221
Upstream	1 01 09-07-1999 10:39:40 01:00	9527	14430	4706	8475	12690	7666	9866	10160	2511	5473	3338	1182	208	337	237
Upstream	1 01 09-07-1999 10:42:10 01:00	9610	14360	4626	8202	12570	7743	10050	10420	2486	5518	3260	1077	190	338	237
Upstream	1 01 09-07-1999 10:44:40 01:00	9539	14280	4683	8270	12690	7693	10020	10060	2504	5565	3401	1058	197	309	231
Upstream	1 01 09-07-1999 10:47:10 01:00	9764	14440	4733	8425	12800	7748	9906	10240	2526	5559	3278	1088	190	307	232
Upstream	1 01 09-07-1999 10:49:40 01:00	9652	14200	4545	8219	12870	7732	9870	10060	2402	5437	3212	1159	197	304	232
U. Bckgrnd	1 01 09-07-1999 10:57:53 01:00	3	0	0	0	0	1	1	1	0	0	1	0	0	0	0

ENTER DATA BELOW

D. Bckgrnd	2 01 09-07-1999 10:16:46 01:00	0	0	0	0	0	0	0	0	0	0	0	0	0	0	
Downstream	2 01 09-07-1999 10:28:25 01:00	9588	14170	4627	8256	12530	7391	9475	9547	2323	4517	2041	408	37	51	24
Downstream	2 01 09-07-1999 10:30:55 01:00	9680	14600	4693	8548	12880	7718	9793	10110	2326	4727	2042	416	46	59	12
Downstream	2 01 09-07-1999 10:33:25 01:00	9589	14600	4563	8392	12910	7639	9846	9716	2353	4596	2022	373	28	54	19
Downstream	2 01 09-07-1999 10:35:55 01:00	9375	14000	4571	8180	13030	7675	9643	9489	2263	4608	2118	391	38	37	15
Downstream	2 01 09-07-1999 10:38:25 01:00	9649	14070	4488	7967	12370	7393	9563	9508	2163	4266	1858	354	18	36	15
Downstream	2 01 09-07-1999 10:40:55 01:00	9546	14360	4612	8297	12850	7434	9663	9585	2232	4304	1912	373	36	43	18
Downstream	2 01 09-07-1999 10:43:25 01:00	9478	14200	4436	8139	12380	7443	9456	9321	2214	4334	1852	343	34	45	23
Downstream	2 01 09-07-1999 10:45:55 01:00	9512	14030	4464	8055	12370	7215	9333	9165	2074	4333	1825	340	30	32	14
Downstream	2 01 09-07-1999 10:48:25 01:00	9748	14610	4601	8436	13020	7547	9759	9446	2202	4432	1849	351	25	25	17
Downstream	2 01 09-07-1999 10:50:55 01:00	9226	14090	4532	8215	12600	7425	9273	9168	2147	4195	1825	325	34	30	9
D. Bckgrnd	2 01 09-07-1999 10:59:08 01:00	3	2	1	1	2	1	3	1	0	0	1	0	0	0	0

Meas. Penetration	0.99	1.00	0.99	0.99	1.00	0.97	0.96	0.92	0.88	0.79	0.57	0.31	0.16	0.13	0.07
P100 correction values	1.00	1.01	1.00	1.01	1.01	1.01	1.00	1.00	1.01	1.00	0.97	0.88	0.82	0.83	0.78
Corrected Penetration	0.99	0.99	0.98	0.98	0.99	0.96	0.96	0.92	0.87	0.78	0.59	0.36	0.20	0.15	0.09
Corrected Efficiency (%)	1	1	2	2	1	4	4	8	13	22	41	64	80	85	91

Data Acceptance Criteria:

Total Challenge Counts for Each Channel:	95884	143010	46177	83381	127370	77154	100051	103633	25441	56347	33647	11698	1981	3292	2366
Data Quality Objective:	> 500	> 500	> 500	> 500	> 500	> 500	> 500	> 500	> 500	> 500	> 500	> 500	> 500	> 500	> 500
Does this meet DQO:	Yes	Yes	Yes	Yes	Yes	Yes	Yes	Yes	Yes	Yes	Yes	Yes	Yes	Yes	Yes

Standard Deviation of Penetration for Each Channel :	0.04	0.04	0.04	0.04	0.04	0.04	0.05	0.06	0.06	0.05	0.04	0.04	0.04	0.03	0.02
Data Quality Objective:	<0.10	<0.10	<0.10	<0.10	<0.10	<0.10	<0.10	<0.10	<0.10	<0.30	<0.30	<0.30	<0.30	<0.30	<0.30
Does this meet DQO:	Yes	Yes	Yes	Yes	Yes	Yes	Yes	Yes	Yes	Yes	Yes	Yes	Yes	Yes	Yes

Maximum observed particle concentration (#/cc):	17.5
Data Quality Objective: max. allowable conc. (#/cc):	< 23
Does this meet the DQO:	Yes, (applies to all channels)

Test No. 09079903

No Filter

Solid-Phase

Particle Counts per Indicated OPC Channel (1-Minute Samples @ 7.1 L/min)

OPC Channel Number	1	2	3	4	5	6	7	8	9	10	11	12	13	14	15
Min. Diam. (um)	0.45	0.59	0.73	0.80	1.02	1.44	1.86	2.28	2.85	3.13	4.25	5.66	7.07	7.77	9.88
Max. Diam. (um)	0.59	0.73	0.80	1.02	1.44	1.86	2.28	2.85	3.13	4.25	5.66	7.07	7.77	9.88	14.10
Geo. Mean Diam (um)	0.52	0.66	0.77	0.90	1.21	1.64	2.06	2.55	2.98	3.65	4.91	6.33	7.41	8.76	11.81

ENTER DATA BELOW

U. Bckgrnd	1 01 09-07-1999 11:20:00 01:00	0	0	2	0	1	1	0	1	0	0	0	0	0	0	0
Upstream	1 01 09-07-1999 11:36:34 01:00	9752	14500	4633	7966	12240	7259	9589	9944	2437	5297	3035	1047	164	308	238
Upstream	1 01 09-07-1999 11:39:04 01:00	10330	15800	4973	8842	13330	7998	10370	10440	2472	5426	3350	1123	199	324	231
Upstream	1 01 09-07-1999 11:41:34 01:00	10300	15210	4874	8984	13610	7959	10360	10310	2494	5489	3240	1047	172	307	237
Upstream	1 01 09-07-1999 11:44:04 01:00	8887	13410	4260	7600	11900	7004	9227	9537	2317	5027	3173	1152	181	341	237
Upstream	1 01 09-07-1999 11:46:34 01:00	10180	15200	4865	8861	13360	7760	10090	10660	2603	5764	3292	1245	182	327	267
Upstream	1 01 09-07-1999 11:49:04 01:00	10220	15570	4892	8765	13260	7775	10190	10600	2649	5558	3374	1236	216	396	253
Upstream	1 01 09-07-1999 11:51:34 01:00	9957	14890	4807	8603	13280	7989	10090	10370	2677	5501	3414	1277	207	341	235
Upstream	1 01 09-07-1999 11:54:04 01:00	10700	15760	5046	9009	13790	8147	10720	10970	2716	5802	3543	1222	202	360	241
Upstream	1 01 09-07-1999 11:56:34 01:00	10520	15300	4914	8792	13730	8108	10540	10600	2621	5672	3298	1119	227	369	220
Upstream	1 01 09-07-1999 12:01:34 01:00	10410	15570	4999	8898	13480	8005	10350	10500	2527	5599	3277	1155	193	346	241
U. Bckgrnd	1 01 09-07-1999 12:09:34 01:00	3	1	0	0	0	0	4	2	0	0	0	0	0	0	0

ENTER DATA BELOW

D. Bckgrnd	2 01 09-07-1999 11:21:15 01:00	1	1	0	0	1	0	0	0	0	0	0	0	0	0	0
Downstream	2 01 09-07-1999 11:37:49 01:00	10250	15090	4782	8456	13040	7622	9892	10140	2394	5325	2975	973	144	272	190
Downstream	2 01 09-07-1999 11:40:19 01:00	10820	15970	5082	9115	13600	8178	10480	10350	2448	5514	3075	965	149	276	201
Downstream	2 01 09-07-1999 11:42:49 01:00	10570	15800	4978	9006	13700	8132	10220	9995	2428	5243	3027	961	149	275	182
Downstream	2 01 09-07-1999 11:45:19 01:00	10010	14680	4843	8507	12920	7591	9923	10420	2521	5506	3188	1040	182	288	192
Downstream	2 01 09-07-1999 11:47:49 01:00	10260	15040	4932	8810	13120	7907	10230	10520	2714	5684	3171	1059	163	297	204
Downstream	2 01 09-07-1999 11:50:19 01:00	10150	15220	5017	8801	13500	7959	10410	10580	2612	5533	3356	1107	183	296	216
Downstream	2 01 09-07-1999 11:52:49 01:00	10170	15280	4798	8760	13430	7960	10210	10600	2604	5412	3268	1106	141	290	196
Downstream	2 01 09-07-1999 11:55:19 01:00	10100	15560	4788	9027	13950	8109	10560	10460	2626	5648	3235	1159	182	281	206
Downstream	2 01 09-07-1999 11:57:49 01:00	10800	15990	5146	9416	14320	8466	10810	10750	2674	5839	3314	1085	160	304	200
Downstream	2 01 09-07-1999 12:02:49 01:00	10410	15640	5025	8909	13370	7906	10300	10270	2478	5338	3050	961	165	286	189
D. Bckgrnd	2 01 09-07-1999 12:10:49 01:00	0	1	0	0	0	0	1	1	0	0	0	0	0	0	0

Meas. Penetration	1.02	1.02	1.02	1.03	1.02	1.02	1.02	1.00	1.00	1.00	0.96	0.90	0.83	0.84	0.82
P100 correction values	1.00	1.00	1.00	1.00	1.00	1.00	1.00	1.00	1.00	1.00	1.00	1.00	1.00	1.00	1.00
Corrected Penetration	1.02	1.02	1.02	1.03	1.02	1.02	1.02	1.00	1.00	1.00	0.96	0.90	0.83	0.84	0.82
Corrected Efficiency (%)	-2	-2	-2	-3	-2	-2	-2	0	0	0	4	10	17	16	18

Data Acceptance Criteria:

Total Challenge Counts for Each Channel:	101256	151210	48263	86320	131980	78004	101526	103931	25513	55135	32996	11623	1943	3419	2400
Data Quality Objective:	> 500	> 500	> 500	> 500	> 500	> 500	> 500	> 500	> 500	> 500	> 500	> 500	> 500	> 500	> 500
Does this meet DQO:	Yes	Yes	Yes	Yes	Yes	Yes	Yes	Yes	Yes	Yes	Yes	Yes	Yes	Yes	Yes

Standard Deviation of Penetration for Each Channel :	0.06	0.06	0.06	0.06	0.06	0.06	0.05	0.04	0.07	0.05	0.06	0.09	0.12	0.07	0.06
Data Quality Objective:	<0.10	<0.10	<0.10	<0.10	<0.10	<0.10	<0.10	<0.10	<0.10	<0.30	<0.30	<0.30	<0.30	<0.30	<0.30
Does this meet DQO:	Yes	Yes	Yes	Yes	Yes	Yes	Yes	Yes	Yes	Yes	Yes	Yes	Yes	Yes	Yes

Maximum observed particle concentration (#/cc):	17.9
Data Quality Objective: max. allowable conc. (#/cc):	< 23
Does this meet the DQO:	Yes, (applies to all channels)

US EPA ARCHIVE DOCUMENT

Test No. 09079904
 Arrestor
 Solid-Phase

Particle Counts per Indicated OPC Channel (1-Minute Samples @ 7.1 L/min)

OPC Channel Number	1	2	3	4	5	6	7	8	9	10	11	12	13	14	15
Min. Diam. (um)	0.45	0.59	0.73	0.80	1.02	1.44	1.86	2.28	2.85	3.13	4.25	5.66	7.07	7.77	9.88
Max. Diam. (um)	0.59	0.73	0.80	1.02	1.44	1.86	2.28	2.85	3.13	4.25	5.66	7.07	7.77	9.88	14.10
Geo. Mean Diam (um)	0.52	0.66	0.77	0.90	1.21	1.64	2.06	2.55	2.98	3.65	4.91	6.33	7.41	8.76	11.81

ENTER DATA BELOW

U. Bckgrnd	1 01 09-07-1999 12:57:38 01:00	0	1	0	0	1	0	0	2	0	1	0	0	0	0	
Upstream	1 01 09-07-1999 13:05:36 01:00	10750	15700	5124	9107	13580	8209	10700	10720	2614	5621	3291	1209	203	337	254
Upstream	1 01 09-07-1999 13:08:06 01:00	10110	15420	4821	8824	13030	7908	10390	10170	2483	5431	3257	1120	208	325	208
Upstream	1 01 09-07-1999 13:10:36 01:00	10140	15330	4986	8589	12960	7961	10240	10200	2488	5332	3227	1144	200	283	244
Upstream	1 01 09-07-1999 13:13:06 01:00	9362	14320	4514	8210	12210	7425	9661	9742	2366	5089	2994	1034	158	284	217
Upstream	1 01 09-07-1999 13:15:36 01:00	10260	15340	5062	8968	13510	8015	10400	10540	2590	5470	3216	1172	179	354	260
Upstream	1 01 09-07-1999 13:18:06 01:00	10760	16000	5150	9104	13740	8191	10870	10930	2564	5712	3369	1176	213	353	224
Upstream	1 01 09-07-1999 13:20:36 01:00	9295	13970	4435	8223	12500	7346	9737	9975	2419	5288	3257	1198	214	367	230
Upstream	1 01 09-07-1999 13:23:06 01:00	10120	15160	4823	8846	13580	8112	10450	10810	2685	5869	3671	1194	232	336	240
Upstream	1 01 09-07-1999 13:25:36 01:00	9935	14300	4480	8470	12780	7677	10120	10310	2615	5816	3431	1222	202	378	293
Upstream	1 01 09-07-1999 13:28:06 01:00	10310	14940	4746	8733	13450	7977	10390	10810	2657	5965	3446	1269	204	379	257
U. Bckgrnd	1 01 09-07-1999 13:40:59 01:00	0	0	0	0	0	0	0	0	0	0	0	0	0	0	

ENTER DATA BELOW

D. Bckgrnd	2 01 09-07-1999 12:58:53 01:00	4	3	0	0	0	1	0	1	0	0	1	2	1	0	0
Downstream	2 01 09-07-1999 13:06:51 01:00	10130	15240	4732	8462	12740	7186	8877	7452	1492	2213	571	51	5	4	0
Downstream	2 01 09-07-1999 13:09:21 01:00	10160	14990	4791	8454	12250	7276	8634	7600	1445	2188	532	57	3	0	0
Downstream	2 01 09-07-1999 13:11:51 01:00	9894	14880	4775	8298	12210	6959	8660	7464	1388	2179	521	76	2	2	1
Downstream	2 01 09-07-1999 13:14:21 01:00	9520	14290	4587	8072	11840	6750	8365	7165	1347	2135	526	67	1	5	1
Downstream	2 01 09-07-1999 13:16:51 01:00	10340	15470	4717	8668	12820	7424	9133	7767	1471	2361	594	45	5	1	0
Downstream	2 01 09-07-1999 13:19:21 01:00	10850	15970	4999	9208	13690	7813	9685	8128	1580	2458	619	57	4	3	1
Downstream	2 01 09-07-1999 13:21:51 01:00	10630	16110	4926	9016	14030	8043	9829	8632	1671	2851	741	67	5	6	1
Downstream	2 01 09-07-1999 13:24:21 01:00	9907	14830	4546	8330	12620	7265	9020	7997	1661	2705	685	64	7	4	0
Downstream	2 01 09-07-1999 13:26:51 01:00	9738	14390	4617	8252	12250	7119	8784	7993	1606	2596	692	86	7	8	1
Downstream	2 01 09-07-1999 13:29:21 01:00	9646	14480	4506	8185	12220	7026	8750	7969	1622	2642	663	79	3	6	0
D. Bckgrnd	2 01 09-07-1999 13:42:14 01:00	2	2	0	0	1	0	0	0	0	0	0	0	0	0	0

Meas. Penetration	1.00	1.00	0.98	0.98	0.96	0.92	0.87	0.75	0.60	0.44	0.19	0.05	0.02	0.01	0.00
P100 correction values	1.02	1.02	1.02	1.03	1.02	1.02	1.02	1.00	1.00	1.00	0.96	0.90	0.83	0.84	0.82
Corrected Penetration	0.98	0.98	0.96	0.95	0.94	0.90	0.86	0.75	0.60	0.44	0.19	0.06	0.02	0.01	0.00
Corrected Efficiency (%)	2	2	4	5	6	10	14	25	40	56	81	94	98	99	100

Data Acceptance Criteria:

Total Challenge Counts for Each Channel:	101042	150480	48141	87074	131340	78821	102958	104207	25481	55593	33159	11738	2013	3396	2427
Data Quality Objective:	> 500	> 500	> 500	> 500	> 500	> 500	> 500	> 500	> 500	> 500	> 500	> 500	> 500	> 500	> 500
Does this meet DQO:	Yes	Yes	Yes	Yes	Yes	Yes	Yes	Yes	Yes	Yes	Yes	Yes	Yes	Yes	Yes

Standard Deviation of Penetration for Each Channel :	0.06	0.06	0.06	0.06	0.07	0.06	0.06	0.05	0.05	0.05	0.03	0.01	0.01	0.01	0.00
Data Quality Objective:	<0.10	<0.10	<0.10	<0.10	<0.10	<0.10	<0.10	<0.10	<0.10	<0.30	<0.30	<0.30	<0.30	<0.30	<0.30
Does this meet DQO:	Yes	Yes	Yes	Yes	Yes	Yes	Yes	Yes	Yes	Yes	Yes	Yes	Yes	Yes	Yes

Maximum observed particle concentration (#/cc):	17.8
Data Quality Objective: max. allowable conc. (#/cc):	< 23
Does this meet the DQO:	Yes, (applies to all channels)

US EPA ARCHIVE DOCUMENT

Test No. 09079905
 No Filter
 Solid-Phase

Particle Counts per Indicated OPC Channel (1-Minute Samples @ 7.1 L/min)

OPC Channel Number	1	2	3	4	5	6	7	8	9	10	11	12	13	14	15
Min. Diam. (um)	0.45	0.59	0.73	0.80	1.02	1.44	1.86	2.28	2.85	3.13	4.25	5.66	7.07	7.77	9.88
Max. Diam. (um)	0.59	0.73	0.80	1.02	1.44	1.86	2.28	2.85	3.13	4.25	5.66	7.07	7.77	9.88	14.10
Geo. Mean Diam (um)	0.52	0.66	0.77	0.90	1.21	1.64	2.06	2.55	2.98	3.65	4.91	6.33	7.41	8.76	11.81

ENTER DATA BELOW

U. Bckgrnd	1 01 09-07-1999 14:03:57 01:00	0	0	0	0	0	0	0	0	0	0	0	0	0	0	
Upstream	1 01 09-07-1999 14:14:22 01:00	10610	15600	4985	9054	13660	8107	10820	10680	2641	5717	3373	1180	186	364	245
Upstream	1 01 09-07-1999 14:16:52 01:00	10420	15450	5020	8889	13520	8311	10570	10970	2672	5727	3402	1188	224	356	259
Upstream	1 01 09-07-1999 14:19:22 01:00	10200	14820	4956	8624	13100	7772	10340	10420	2583	5512	3299	1234	187	314	242
Upstream	1 01 09-07-1999 14:21:52 01:00	10380	15280	4825	8771	13390	8369	10520	10660	2662	5690	3365	1175	197	347	234
Upstream	1 01 09-07-1999 14:24:22 01:00	10260	15050	4700	8534	13270	7821	10310	10340	2663	5425	3304	1217	196	366	251
Upstream	1 01 09-07-1999 14:26:52 01:00	10400	15320	4956	8956	13530	8133	10660	10610	2451	5709	3557	1173	207	379	239
Upstream	1 01 09-07-1999 14:29:22 01:00	9565	14160	4414	8356	12620	7555	9899	10270	2527	5428	3371	1234	234	359	282
Upstream	1 01 09-07-1999 14:31:52 01:00	10130	14700	4724	8518	13320	7884	10310	10700	2793	5897	3617	1264	230	370	283
Upstream	1 01 09-07-1999 14:34:22 01:00	9889	14750	4862	8609	13280	8001	10350	10640	2628	5878	3672	1302	211	368	268
Upstream	1 01 09-07-1999 14:36:52 01:00	9821	14390	4793	8595	12830	7842	10120	10300	2649	5646	3448	1266	224	383	286
U. Bckgrnd	1 01 09-07-1999 14:44:59 01:00	2	0	0	0	0	0	0	0	0	0	0	0	0	0	

ENTER DATA BELOW

D. Bckgrnd	2 01 09-07-1999 14:05:12 01:00	0	0	0	0	0	0	0	0	0	0	0	0	0	0	
Downstream	2 01 09-07-1999 14:15:37 01:00	10390	14870	4937	8543	13240	7689	10350	10390	2635	5479	3128	1015	155	267	217
Downstream	2 01 09-07-1999 14:18:07 01:00	10400	14950	4958	8567	13060	7602	10360	10590	2515	5535	3101	1144	157	298	207
Downstream	2 01 09-07-1999 14:20:37 01:00	9890	14800	4765	8376	12720	7679	9987	10170	2401	5381	3198	982	152	294	196
Downstream	2 01 09-07-1999 14:23:07 01:00	10750	15520	4885	8964	13630	8246	10650	10820	2579	5680	3215	1052	181	305	221
Downstream	2 01 09-07-1999 14:25:37 01:00	10050	15090	4655	8577	13380	7928	10270	10250	2431	5442	3199	1061	162	266	202
Downstream	2 01 09-07-1999 14:28:07 01:00	10880	15820	4936	9077	14140	8389	10640	10570	2502	5710	3197	1035	164	260	173
Downstream	2 01 09-07-1999 14:30:37 01:00	10300	14500	4776	8653	13340	7781	10250	10680	2673	5812	3551	1132	190	315	219
Downstream	2 01 09-07-1999 14:33:07 01:00	9796	14580	4684	8590	13160	7729	10270	10570	2686	5792	3382	1106	170	330	237
Downstream	2 01 09-07-1999 14:35:37 01:00	9975	14610	4626	8536	13290	7819	10360	10520	2595	5694	3418	1149	181	276	218
Downstream	2 01 09-07-1999 14:38:07 01:00	9944	14400	4524	8451	13090	7781	10100	10380	2685	5729	3380	1111	162	326	202
D. Bckgrnd	2 01 09-07-1999 14:46:14 01:00	1	3	0	0	1	0	1	0	0	1	0	0	0	0	

Meas. Penetration	1.01	1.00	0.99	0.99	1.00	0.99	0.99	0.99	0.98	0.99	0.95	0.88	0.80	0.81	0.81
P100 correction values	1.00	1.00	1.00	1.00	1.00	1.00	1.00	1.00	1.00	1.00	1.00	1.00	1.00	1.00	1.00
Corrected Penetration	1.01	1.00	0.99	0.99	1.00	0.99	0.99	0.99	0.98	0.99	0.95	0.88	0.80	0.81	0.81
Corrected Efficiency (%)	-1	0	1	1	0	1	1	1	2	1	5	12	20	19	19

Data Acceptance Criteria:

Total Challenge Counts for Each Channel:	101675	149520	48235	86906	132520	79795	103899	105590	26269	56629	34408	12233	2096	3606	2589
Data Quality Objective:	> 500	> 500	> 500	> 500	> 500	> 500	> 500	> 500	> 500	> 500	> 500	> 500	> 500	> 500	> 500
Does this meet DQO:	Yes	Yes	Yes	Yes	Yes	Yes	Yes	Yes	Yes	Yes	Yes	Yes	Yes	Yes	Yes

Standard Deviation of Penetration for Each Channel :	0.05	0.04	0.05	0.04	0.04	0.04	0.03	0.03	0.05	0.04	0.06	0.06	0.09	0.08	0.09
Data Quality Objective:	<0.10	<0.10	<0.10	<0.10	<0.10	<0.10	<0.10	<0.10	<0.10	<0.30	<0.30	<0.30	<0.30	<0.30	<0.30
Does this meet DQO:	Yes	Yes	Yes	Yes	Yes	Yes	Yes	Yes	Yes	Yes	Yes	Yes	Yes	Yes	Yes

Maximum observed particle concentration (#/cc):	17.6
Data Quality Objective: max. allowable conc. (#/cc):	< 23
Does this meet the DQO:	Yes, (applies to all channels)

Test No. 09079906
 Arrestor
 Solid-Phase

Particle Counts per Indicated OPC Channel (1-Minute Samples @ 7.1 L/min)

OPC Channel Number	1	2	3	4	5	6	7	8	9	10	11	12	13	14	15
Min. Diam. (um)	0.45	0.59	0.73	0.80	1.02	1.44	1.86	2.28	2.85	3.13	4.25	5.66	7.07	7.77	9.88
Max. Diam. (um)	0.59	0.73	0.80	1.02	1.44	1.86	2.28	2.85	3.13	4.25	5.66	7.07	7.77	9.88	14.10
Geo. Mean Diam (um)	0.52	0.66	0.77	0.90	1.21	1.64	2.06	2.55	2.98	3.65	4.91	6.33	7.41	8.76	11.81

ENTER DATA BELOW

U. Bckgrnd	1	01	09-07-1999	14:55:21	01:00	0	0	0	0	0	0	0	0	0	0	0				
Upstream	1	01	09-07-1999	15:02:04	01:00	10530	15250	4867	8997	13870	8075	10470	10490	2614	5662	3479	1279	197	337	227
Upstream	1	01	09-07-1999	15:04:34	01:00	10510	15360	4815	9035	13530	8310	10700	10790	2626	5749	3433	1188	220	348	266
Upstream	1	01	09-07-1999	15:07:04	01:00	10300	14880	4901	8784	13540	8108	10520	10570	2561	5829	3481	1213	213	343	258
Upstream	1	01	09-07-1999	15:09:34	01:00	10020	14960	4878	8716	13300	7821	10260	10350	2591	5598	3420	1145	199	350	257
Upstream	1	01	09-07-1999	15:12:04	01:00	10100	14580	4833	8638	13230	7945	10300	10280	2598	5517	3261	1107	201	346	254
Upstream	1	01	09-07-1999	15:14:34	01:00	10520	15270	5002	8723	13400	8163	10730	10750	2638	5849	3437	1207	228	346	244
Upstream	1	01	09-07-1999	15:17:04	01:00	9827	14370	4662	8279	12680	7711	9925	9889	2520	5332	3210	1135	191	348	201
Upstream	1	01	09-07-1999	15:19:34	01:00	10100	14730	4798	8558	13440	7978	10390	10210	2582	5577	3304	1142	210	335	279
Upstream	1	01	09-07-1999	15:22:04	01:00	9992	14760	4807	8557	12990	7750	10270	10290	2485	5505	3296	1183	202	340	251
Upstream	1	01	09-07-1999	15:24:34	01:00	9393	14470	4647	8357	12960	7725	10050	10090	2506	5485	3328	1144	203	316	223
U. Bckgrnd	1	01	09-07-1999	15:32:58	01:00	0	1	0	0	1	0	0	0	0	0	0	0	0	0	0

ENTER DATA BELOW

D. Bckgrnd	2	01	09-07-1999	14:56:36	01:00	0	0	0	0	0	0	0	0	0	0	0	0	0	0	0
Downstream	2	01	09-07-1999	15:03:19	01:00	10270	15340	4691	8817	13410	7683	9087	7806	1548	2447	681	81	3	6	4
Downstream	2	01	09-07-1999	15:05:49	01:00	9884	14380	4576	8272	12460	7293	8845	7547	1463	2332	670	88	5	10	2
Downstream	2	01	09-07-1999	15:08:19	01:00	9868	14530	4502	8089	12460	7117	8867	7469	1514	2483	709	70	6	2	0
Downstream	2	01	09-07-1999	15:10:49	01:00	9772	14260	4613	8001	12280	7071	8724	7375	1394	2362	671	81	8	4	1
Downstream	2	01	09-07-1999	15:13:19	01:00	9966	14610	4645	8452	12670	7345	9151	7849	1478	2464	701	81	6	6	1
Downstream	2	01	09-07-1999	15:15:49	01:00	9956	14380	4640	8228	12380	7045	8733	7549	1454	2411	717	67	5	3	0
Downstream	2	01	09-07-1999	15:18:19	01:00	10000	15330	4784	8511	13230	7627	9096	7949	1532	2555	670	75	10	6	1
Downstream	2	01	09-07-1999	15:20:49	01:00	9588	14590	4542	8092	12780	7223	8692	7118	1475	2410	640	64	6	6	0
Downstream	2	01	09-07-1999	15:23:19	01:00	9518	14240	4641	8283	12230	7156	8724	7570	1525	2409	691	67	6	7	0
Downstream	2	01	09-07-1999	15:25:49	01:00	9794	14490	4574	8528	12520	7240	9091	7634	1599	2546	703	90	8	4	0
D. Bckgrnd	2	01	09-07-1999	15:34:13	01:00	0	1	0	2	1	0	1	0	0	0	0	0	0	0	0

Meas. Penetration	0.97	0.98	0.96	0.96	0.95	0.91	0.86	0.73	0.58	0.44	0.20	0.07	0.03	0.02	0.00
P100 correction values	1.01	1.00	0.99	0.99	1.00	0.99	0.99	0.99	0.98	0.99	0.95	0.88	0.80	0.81	0.81
Corrected Penetration	0.97	0.99	0.97	0.97	0.95	0.93	0.86	0.74	0.60	0.44	0.21	0.07	0.04	0.02	0.00
Corrected Efficiency (%)	3	1	3	3	5	7	14	26	40	56	79	93	96	98	100

Data Acceptance Criteria:

Total Challenge Counts for Each Channel:	101292	148630	48210	86644	132940	79586	103615	103709	25721	56103	33649	11743	2064	3409	2460
Data Quality Objective:	> 500	> 500	> 500	> 500	> 500	> 500	> 500	> 500	> 500	> 500	> 500	> 500	> 500	> 500	> 500
Does this meet DQO:	Yes	Yes	Yes	Yes	Yes	Yes	Yes	Yes	Yes	Yes	Yes	Yes	Yes	Yes	Yes

Standard Deviation of Penetration for Each Channel :

Data Quality Objective:	<0.10	<0.10	<0.10	<0.10	<0.10	<0.10	<0.10	<0.10	<0.10	<0.30	<0.30	<0.30	<0.30	<0.30	<0.30
Does this meet DQO:	Yes	Yes	Yes	Yes	Yes	Yes	Yes	Yes	Yes	Yes	Yes	Yes	Yes	Yes	Yes

Maximum observed particle concentration (#/cc):	17.5
Data Quality Objective: max. allowable conc. (#/cc):	< 23
Does this meet the DQO:	Yes, (applies to all channels)

US EPA ARCHIVE DOCUMENT

Test No. 09079907

No Filter

Solid-Phase

Particle Counts per Indicated OPC Channel (1-Minute Samples @ 7.1 L/min)

OPC Channel Number	1	2	3	4	5	6	7	8	9	10	11	12	13	14	15
Min. Diam. (um)	0.45	0.59	0.73	0.80	1.02	1.44	1.86	2.28	2.85	3.13	4.25	5.66	7.07	7.77	9.88
Max. Diam. (um)	0.59	0.73	0.80	1.02	1.44	1.86	2.28	2.85	3.13	4.25	5.66	7.07	7.77	9.88	14.10
Geo. Mean Diam (um)	0.52	0.66	0.77	0.90	1.21	1.64	2.06	2.55	2.98	3.65	4.91	6.33	7.41	8.76	11.81

ENTER DATA BELOW

U. Bckgrnd	1 01 09-07-1999 15:41:52 01:00	0	0	0	0	0	0	0	0	0	0	0	0	0	0	0
Upstream	1 01 09-07-1999 15:48:34 01:00	10120	15050	4907	8919	13710	8319	10550	10560	2769	5533	3475	1144	177	341	225
Upstream	1 01 09-07-1999 15:51:04 01:00	9942	15250	5005	9120	13800	8160	10740	10750	2696	5691	3501	1237	189	348	265
Upstream	1 01 09-07-1999 15:53:34 01:00	10160	15430	5122	9126	13770	8311	10660	10860	2605	5945	3585	1285	193	343	255
Upstream	1 01 09-07-1999 15:56:04 01:00	9988	14780	4639	8840	13450	8099	10450	10400	2485	5765	3541	1159	226	334	270
Upstream	1 01 09-07-1999 15:58:34 01:00	10040	15050	4739	8922	13530	8262	10700	10680	2600	5827	3594	1250	222	319	272
Upstream	1 01 09-07-1999 16:01:04 01:00	10120	15090	4950	9053	13700	8459	10730	10520	2483	5655	3422	1210	200	328	260
Upstream	1 01 09-07-1999 16:03:34 01:00	10360	15470	4889	8950	13770	8305	10780	10640	2661	5975	3481	1282	201	379	210
Upstream	1 01 09-07-1999 16:06:04 01:00	10110	15370	5015	9145	13750	8351	10880	10730	2636	5782	3485	1186	212	348	258
Upstream	1 01 09-07-1999 16:08:34 01:00	9729	14790	4799	8747	13500	8075	10300	10560	2580	5788	3519	1255	203	348	238
Upstream	1 01 09-07-1999 16:11:04 01:00	9843	14920	4892	8753	13600	7849	10560	10520	2551	5575	3425	1094	197	329	209
U. Bckgrnd	1 01 09-07-1999 16:18:53 01:00	1	1	0	1	0	0	0	0	0	0	0	0	0	0	0

ENTER DATA BELOW

D. Bckgrnd	2 01 09-07-1999 15:43:07 01:00	1	0	0	0	0	0	0	2	0	0	0	0	0	0	0
Downstream	2 01 09-07-1999 15:49:49 01:00	10340	15470	4983	8963	13690	8337	10860	10800	2660	5595	3330	1078	181	303	201
Downstream	2 01 09-07-1999 15:52:19 01:00	10040	15150	4809	8854	13360	8008	10540	10610	2624	5694	3295	1068	175	281	206
Downstream	2 01 09-07-1999 15:54:49 01:00	10320	15160	4877	8716	13620	8252	10520	10770	2695	5855	3298	1085	166	275	228
Downstream	2 01 09-07-1999 15:57:19 01:00	9863	14850	4792	8652	13070	7968	10570	10580	2579	5598	3250	1070	169	279	172
Downstream	2 01 09-07-1999 15:59:49 01:00	10180	15020	4943	8931	13530	8178	10520	10610	2608	5729	3260	1001	192	271	205
Downstream	2 01 09-07-1999 16:02:19 01:00	10190	15200	4874	9067	13830	8424	10520	10610	2603	5647	3346	1032	164	283	191
Downstream	2 01 09-07-1999 16:04:49 01:00	10260	15610	4872	8892	13950	8321	10510	10250	2414	5576	3264	1006	176	255	184
Downstream	2 01 09-07-1999 16:07:19 01:00	9929	14600	4777	8683	13240	8082	10290	10420	2501	5490	3248	1082	160	291	198
Downstream	2 01 09-07-1999 16:09:49 01:00	9556	14390	4723	8566	13040	7872	10080	10350	2616	5691	3179	1110	181	319	199
Downstream	2 01 09-07-1999 16:12:19 01:00	9818	15010	4812	8641	13320	7976	10320	10420	2544	5492	3177	1033	175	297	224
D. Bckgrnd	2 01 09-07-1999 16:20:08 01:00	0	0	0	0	2	1	0	0	0	0	0	0	0	0	0

Meas. Penetration	1.00	1.00	0.99	0.98	0.99	0.99	0.98	0.99	0.99	0.98	0.93	0.87	0.86	0.84	0.82
P100 correction values	1.00	1.00	1.00	1.00	1.00	1.00	1.00	1.00	1.00	1.00	1.00	1.00	1.00	1.00	1.00
Corrected Penetration	1.00	1.00	0.99	0.98	0.99	0.99	0.98	0.99	0.99	0.98	0.93	0.87	0.86	0.84	0.82
Corrected Efficiency (%)	0	0	1	2	1	1	2	1	1	2	7	13	14	16	18

Data Acceptance Criteria:

Total Challenge Counts for Each Channel:	100412	151200	48957	89575	136580	82190	106350	106220	26066	57536	35028	12102	2020	3417	2462
Data Quality Objective:	> 500	> 500	> 500	> 500	> 500	> 500	> 500	> 500	> 500	> 500	> 500	> 500	> 500	> 500	> 500
Does this meet DQO:	Yes	Yes	Yes	Yes	Yes	Yes	Yes	Yes	Yes	Yes	Yes	Yes	Yes	Yes	Yes

Standard Deviation of Penetration for Each Channel :	0.03	0.03	0.03	0.02	0.02	0.03	0.03	0.02	0.05	0.03	0.02	0.05	0.08	0.07	0.10
Data Quality Objective:	<0.10	<0.10	<0.10	<0.10	<0.10	<0.10	<0.10	<0.10	<0.10	<0.30	<0.30	<0.30	<0.30	<0.30	<0.30
Does this meet DQO:	Yes	Yes	Yes	Yes	Yes	Yes	Yes	Yes	Yes	Yes	Yes	Yes	Yes	Yes	Yes

Maximum observed particle concentration (#/cc):	17.6
Data Quality Objective: max. allowable conc. (#/cc):	< 23
Does this meet the DQO:	Yes, (applies to all channels)

Test No. 09079908
 Arrestor
 Solid-Phase

Particle Counts per Indicated OPC Channel (1-Minute Samples @ 7.1 L/min)

OPC Channel Number	1	2	3	4	5	6	7	8	9	10	11	12	13	14	15
Min. Diam. (um)	0.45	0.59	0.73	0.80	1.02	1.44	1.86	2.28	2.85	3.13	4.25	5.66	7.07	7.77	9.88
Max. Diam. (um)	0.59	0.73	0.80	1.02	1.44	1.86	2.28	2.85	3.13	4.25	5.66	7.07	7.77	9.88	14.10
Geo. Mean Diam (um)	0.52	0.66	0.77	0.90	1.21	1.64	2.06	2.55	2.98	3.65	4.91	6.33	7.41	8.76	11.81

ENTER DATA BELOW

U. Bckgrnd	1 01 09-07-1999 16:29:22 01:00	0	0	0	0	0	0	0	0	0	0	0	0	0	0	
Upstream	1 01 09-07-1999 16:36:10 01:00	10320	15030	4883	9091	14070	8186	10870	10580	2763	5985	3576	1326	197	355	279
Upstream	1 01 09-07-1999 16:38:40 01:00	10360	15650	5047	9117	14090	8236	10800	11130	2729	5879	3572	1326	231	361	267
Upstream	1 01 09-07-1999 16:41:10 01:00	10860	16000	5204	9397	14390	8597	11360	11110	2708	6047	3574	1284	224	358	284
Upstream	1 01 09-07-1999 16:43:40 01:00	10260	15380	5008	9106	14060	8306	10890	11130	2767	6084	3661	1250	245	371	279
Upstream	1 01 09-07-1999 16:46:10 01:00	10290	15360	5015	9219	14050	8312	10810	11090	2702	5981	3526	1263	214	382	250
Upstream	1 01 09-07-1999 16:48:40 01:00	10580	15650	5109	9139	14140	8577	10840	10990	2664	5918	3763	1280	197	356	258
Upstream	1 01 09-07-1999 16:51:10 01:00	9196	13820	4328	7987	12320	7317	9593	9354	2244	5072	3086	1056	148	304	205
Upstream	1 01 09-07-1999 16:53:40 01:00	10560	15690	4941	9070	14280	8444	10840	10490	2616	5664	3404	1138	213	341	271
Upstream	1 01 09-07-1999 16:56:10 01:00	9894	15000	4818	8982	13340	8066	10570	10390	2613	5532	3250	1127	185	314	216
Upstream	1 01 09-07-1999 16:58:40 01:00	9886	14670	4663	8623	13130	8039	10480	10060	2519	5364	3353	1122	214	340	228
U. Bckgrnd	1 01 09-07-1999 17:06:29 01:00	1	1	0	0	1	1	0	0	0	0	0	0	0	0	0

ENTER DATA BELOW

D. Bckgrnd	2 01 09-07-1999 16:30:37 01:00	0	1	1	1	0	0	0	0	0	0	0	0	0	0	
Downstream	2 01 09-07-1999 16:37:25 01:00	10540	15990	4856	9040	13640	7902	9201	7859	1405	2203	456	46	2	6	1
Downstream	2 01 09-07-1999 16:39:55 01:00	10230	15000	4587	8466	12860	7388	9168	7549	1396	2259	509	47	4	4	0
Downstream	2 01 09-07-1999 16:42:25 01:00	10290	14920	4666	8582	12840	7422	9247	7577	1367	2114	448	38	4	4	0
Downstream	2 01 09-07-1999 16:44:55 01:00	9997	14530	4616	8492	12780	7357	8933	7559	1479	2018	513	40	1	1	1
Downstream	2 01 09-07-1999 16:47:25 01:00	10430	15100	4918	8976	13410	7771	9346	7845	1463	2252	520	52	2	6	1
Downstream	2 01 09-07-1999 16:49:55 01:00	10120	15050	4718	8868	13190	7715	9343	7507	1429	2206	527	43	3	5	2
Downstream	2 01 09-07-1999 16:52:25 01:00	10560	15740	4988	9068	13950	7906	9406	7470	1384	2071	450	33	1	4	0
Downstream	2 01 09-07-1999 16:54:55 01:00	9957	15060	4809	8714	13140	7430	8838	7282	1359	2130	441	35	2	3	1
Downstream	2 01 09-07-1999 16:57:25 01:00	9972	14900	4639	8577	12880	7277	8783	7102	1317	1947	391	39	2	1	1
Downstream	2 01 09-07-1999 16:59:55 01:00	9997	14930	4843	8640	13210	7391	8789	7071	1347	2062	432	50	2	3	1
D. Bckgrnd	2 01 09-07-1999 17:07:44 01:00	3	0	0	1	3	0	1	0	0	0	0	0	0	0	0

Meas. Penetration	1.00	0.99	0.97	0.97	0.96	0.92	0.85	0.70	0.53	0.37	0.13	0.03	0.01	0.01	0.00
P100 correction values	1.00	1.00	0.99	0.98	0.99	0.99	0.98	0.99	0.99	0.98	0.93	0.87	0.86	0.84	0.82
Corrected Penetration	1.00	1.00	0.98	0.99	0.97	0.93	0.86	0.71	0.53	0.38	0.14	0.04	0.01	0.01	0.00
Corrected Efficiency (%)	0	0	2	1	3	7	14	29	47	62	86	96	99	99	100

Data Acceptance Criteria:

Total Challenge Counts for Each Channel:	102206	152250	49016	89731	137870	82080	107053	106324	26325	57526	34765	12172	2068	3482	2537
Data Quality Objective:	> 500	> 500	> 500	> 500	> 500	> 500	> 500	> 500	> 500	> 500	> 500	> 500	> 500	> 500	> 500
Does this meet DQO:	Yes	Yes	Yes	Yes	Yes	Yes	Yes	Yes	Yes	Yes	Yes	Yes	Yes	Yes	Yes

Standard Deviation of Penetration for Each Channel :	0.05	0.05	0.06	0.05	0.05	0.05	0.04	0.05	0.04	0.03	0.02	0.01	0.01	0.01	0.00
Data Quality Objective:	<0.10	<0.10	<0.10	<0.10	<0.10	<0.10	<0.10	<0.10	<0.10	<0.30	<0.30	<0.30	<0.30	<0.30	<0.30
Does this meet DQO:	Yes	Yes	Yes	Yes	Yes	Yes	Yes	Yes	Yes	Yes	Yes	Yes	Yes	Yes	Yes

Maximum observed particle concentration (#/cc):	18.3
Data Quality Objective: max. allowable conc. (#/cc):	< 23
Does this meet the DQO:	Yes, (applies to all channels)

US EPA ARCHIVE DOCUMENT

Test No. 08319904
 HEPA
 Solid-Phase

Particle Counts per Indicated OPC Channel (1-Minute Samples @ 7.1 L/min)

OPC Channel Number	1	2	3	4	5	6	7	8	9	10	11	12	13	14	15
Min. Diam. (um)	0.45	0.59	0.73	0.80	1.02	1.44	1.86	2.28	2.85	3.13	4.25	5.66	7.07	7.77	9.88
Max. Diam. (um)	0.59	0.73	0.80	1.02	1.44	1.86	2.28	2.85	3.13	4.25	5.66	7.07	7.77	9.88	14.10
Geo. Mean Diam (um)	0.52	0.66	0.77	0.90	1.21	1.64	2.06	2.55	2.98	3.65	4.91	6.33	7.41	8.76	11.81

ENTER DATA BELOW

U. Bckgrnd	1 01 08-31-1999 13:21:20 01:00	0	0	0	0	0	0	0	0	0	0	0	0	0	0
Upstream	1 01 08-31-1999 13:30:30 01:00	9906	15210	4721	8631	13060	7586	10050	11040	2743	5920	3442	1149	191	297
Upstream	1 01 08-31-1999 13:33:00 01:00	10140	15260	4804	8950	13360	7959	10180	11250	2837	6030	3564	1170	200	303
Upstream	1 01 08-31-1999 13:35:30 01:00	10410	15560	4867	9101	13840	8060	10440	11550	2828	6156	3569	1175	204	309
Upstream	1 01 08-31-1999 13:38:00 01:00	10020	14890	4814	8556	13350	7905	10220	11320	2790	6017	3444	1167	201	320
Upstream	1 01 08-31-1999 13:40:30 01:00	10100	14850	4829	8570	13280	7877	10120	11290	2726	5961	3453	1288	211	336
Upstream	1 01 08-31-1999 13:43:00 01:00	9782	14920	4769	8396	12730	7719	10000	11070	2828	5833	3446	1167	174	328
Upstream	1 01 08-31-1999 13:45:30 01:00	8866	13340	4235	7393	11380	6768	8732	9584	2284	5022	2752	939	160	254
Upstream	1 01 08-31-1999 13:48:00 01:00	9952	14880	4725	8314	12550	7560	9809	10470	2506	5235	3100	1034	182	302
Upstream	1 01 08-31-1999 13:50:30 01:00	10040	14910	4738	8308	12870	7608	9800	10540	2540	5386	3184	1015	158	261
Upstream	1 01 08-31-1999 13:53:00 01:00	9933	14870	4601	8359	12770	7614	9846	10330	2503	5398	3046	1069	168	289
U. Bckgrnd	1 01 08-31-1999 14:03:28 01:00	0	0	0	0	0	0	0	0	0	0	0	0	0	0

ENTER DATA BELOW

D. Bckgrnd	2 01 08-31-1999 13:22:35 01:00	0	0	0	0	0	0	0	0	0	0	0	0	0	0
Downstream	2 01 08-31-1999 13:31:45 01:00	12	21	2	11	12	6	10	9	6	2	1	1	0	0
Downstream	2 01 08-31-1999 13:34:15 01:00	10	14	3	9	17	8	13	13	2	1	5	0	0	0
Downstream	2 01 08-31-1999 13:36:45 01:00	8	19	4	5	14	8	17	10	1	7	0	2	0	1
Downstream	2 01 08-31-1999 13:39:15 01:00	7	14	6	10	14	10	8	7	1	5	0	2	0	0
Downstream	2 01 08-31-1999 13:41:45 01:00	9	18	4	8	15	8	5	4	1	5	1	0	0	0
Downstream	2 01 08-31-1999 13:44:15 01:00	12	17	2	7	19	11	11	9	0	8	1	1	0	0
Downstream	2 01 08-31-1999 13:46:45 01:00	5	20	4	5	13	7	9	7	3	3	2	0	0	0
Downstream	2 01 08-31-1999 13:49:15 01:00	12	16	5	6	11	4	9	6	2	2	4	0	0	0
Downstream	2 01 08-31-1999 13:51:45 01:00	9	17	5	10	5	10	7	6	3	8	0	0	0	0
Downstream	2 01 08-31-1999 13:54:15 01:00	7	20	1	6	16	9	8	11	1	3	2	0	0	0
D. Bckgrnd	2 01 08-31-1999 14:04:43 01:00	0	2	0	2	1	0	2	2	1	1	0	0	0	0

Meas. Penetration	0.00	0.00	0.00	0.00	0.00	0.00	0.00	0.00	0.00	0.00	0.00	0.00	0.00	0.00	0.00
P100 correction values	1.01	1.00	1.01	1.00	1.01	1.01	1.02	1.03	0.99	1.01	1.01	1.01	1.01	0.95	0.88
Corrected Penetration	0.00	0.00	0.00	0.00	0.00	0.00	0.00	0.00	0.00	0.00	0.00	0.00	0.00	0.00	0.00
Corrected Efficiency (%)	100	100	100	100	100	100	100	100	100	100	100	100	100	100	100

Data Acceptance Criteria:

Total Challenge Counts for Each Channel:	99149	148690	47103	84578	129190	76656	99197	108444	26585	56958	33000	11173	1849	2999	1924
Data Quality Objective:	> 500	> 500	> 500	> 500	> 500	> 500	> 500	> 500	> 500	> 500	> 500	> 500	> 500	> 500	> 500
Does this meet DQO:	Yes	Yes	Yes	Yes	Yes	Yes	Yes	Yes	Yes	Yes	Yes	Yes	Yes	Yes	Yes

Standard Deviation of Penetration for Each Channel :	0.00	0.00	0.00	0.00	0.00	0.00	0.00	0.00	0.00	0.00	0.00	0.00	0.00	0.00	0.00
Data Quality Objective:	<0.10	<0.10	<0.10	<0.10	<0.10	<0.10	<0.10	<0.10	<0.10	< 0.30	< 0.30	< 0.30	< 0.30	< 0.30	< 0.30
Does this meet DQO:	Yes	Yes	Yes	Yes	Yes	Yes	Yes	Yes	Yes	Yes	Yes	Yes	Yes	Yes	Yes

Maximum observed particle concentration (#/cc):	17.7
Data Quality Objective: max. allowable conc. (#/cc):	< 23
Does this meet the DQO:	Yes, (applies to all channels)

US EPA ARCHIVE DOCUMENT

Test No. 09089901
 No Filter
 Liquid-Phase

Particle Counts per Indicated OPC Channel (1-Minute Samples @ 7.1 L/min)

OPC Channel Number	1	2	3	4	5	6	7	8	9	10	11	12	13	14	15
Min. Diam. (um)	0.28	0.37	0.47	0.52	0.66	0.94	1.22	1.51	1.88	2.07	2.83	3.77	4.71	5.18	6.60
Max. Diam. (um)	0.37	0.47	0.52	0.66	0.94	1.22	1.51	1.88	2.07	2.83	3.77	4.71	5.18	6.60	9.43
Geo. Mean Diam (um)	0.32	0.42	0.49	0.58	0.78	1.07	1.36	1.68	1.97	2.42	3.26	4.21	4.94	5.85	7.89

ENTER DATA BELOW

U. Bckgrnd	1	01	09-08-1999	06:52:00	01:00	0	0	0	0	0	2	0	1	0	0	0	0			
Upstream	1	01	09-08-1999	07:04:51	01:00	9439	14670	5218	9527	14700	10250	16750	12730	2771	6721	3883	1053	172	211	116
Upstream	1	01	09-08-1999	07:07:21	01:00	9647	15330	5453	9856	14930	10490	17390	13200	2916	6985	4085	1065	178	231	136
Upstream	1	01	09-08-1999	07:09:51	01:00	9257	14220	5150	9395	14240	10130	16240	12230	2759	6410	3770	1017	169	221	132
Upstream	1	01	09-08-1999	07:12:21	01:00	9604	14530	5191	9429	14320	10230	16430	12440	2759	6636	3847	1017	165	233	130
Upstream	1	01	09-08-1999	07:14:51	01:00	9180	13870	4991	8908	13660	9619	15580	11570	2615	6314	3692	966	138	237	123
Upstream	1	01	09-08-1999	07:17:21	01:00	8982	14090	4926	9064	13840	9635	15670	11560	2588	6205	3723	910	151	214	131
Upstream	1	01	09-08-1999	07:19:51	01:00	8562	13350	4617	8462	13010	9275	14690	10770	2392	5891	3335	870	134	186	129
Upstream	1	01	09-08-1999	07:22:21	01:00	9567	14710	5185	9541	14310	10250	16360	12140	2735	6516	3700	1036	118	230	125
Upstream	1	01	09-08-1999	07:24:51	01:00	9826	15260	5425	9622	14810	10480	16860	12370	2826	6801	3829	994	147	217	128
Upstream	1	01	09-08-1999	07:27:21	01:00	9504	14980	5274	9526	14430	10300	16650	12220	2719	6524	3777	955	134	191	130
U. Bckgrnd	1	01	09-08-1999	07:35:25	01:00	0	0	0	0	0	1	0	0	0	0	0	0	0	0	0

ENTER DATA BELOW

D. Bckgrnd	2	01	09-08-1999	06:53:15	01:00	0	1	0	0	1	0	1	2	0	0	0	0	0	0	0
Downstream	2	01	09-08-1999	07:06:06	01:00	9703	15220	5444	9691	14780	10620	17220	13070	2823	6880	3904	974	143	204	72
Downstream	2	01	09-08-1999	07:08:36	01:00	9637	15290	5383	9838	14670	10340	17000	13120	2878	6888	4038	983	149	230	95
Downstream	2	01	09-08-1999	07:11:06	01:00	9450	14780	5284	9769	14640	10290	16700	12830	2806	6746	3752	945	129	199	102
Downstream	2	01	09-08-1999	07:13:36	01:00	9262	14180	4890	9099	14000	9711	16140	12130	2647	6426	3726	933	155	188	83
Downstream	2	01	09-08-1999	07:16:06	01:00	9019	14050	5037	9149	13730	9778	15770	12100	2672	6389	3701	879	118	175	76
Downstream	2	01	09-08-1999	07:18:36	01:00	8922	13960	4914	9103	13910	9712	15870	11830	2626	6122	3645	888	111	199	73
Downstream	2	01	09-08-1999	07:21:06	01:00	9223	14270	5082	9069	13870	9714	16020	11460	2701	6409	3534	850	108	192	72
Downstream	2	01	09-08-1999	07:23:36	01:00	9703	14770	5192	9285	14310	10160	16330	11950	2674	6514	3671	914	123	174	80
Downstream	2	01	09-08-1999	07:26:06	01:00	9902	15460	5385	9842	14720	10490	17010	12640	2823	6709	3912	922	136	220	69
Downstream	2	01	09-08-1999	07:28:36	01:00	9668	15180	5385	9615	14660	10340	16520	11980	2841	6454	3685	948	120	164	81
D. Bckgrnd	2	01	09-08-1999	07:36:40	01:00	0	0	0	0	0	0	0	0	0	0	0	0	0	0	0

Meas. Penetration	1.01	1.01	1.01	1.01	1.01	1.00	1.01	1.02	1.02	1.01	1.00	0.93	0.86	0.90	0.63
P100 correction values	1.00	1.00	1.00	1.00	1.00	1.00	1.00	1.00	1.00	1.00	1.00	1.00	1.00	1.00	1.00
Corrected Penetration	1.01	1.01	1.01	1.01	1.01	1.00	1.01	1.02	1.02	1.01	1.00	0.93	0.86	0.90	0.63
Corrected Efficiency (%)	-1	-1	-1	-1	-1	0	-1	-2	-2	-1	0	7	14	10	37

Data Acceptance Criteria:

Total Challenge Counts for Each Channel:	93568	145010	51430	93330	142250	100659	162620	121230	27080	65003	37641	9883	1506	2171	1280
Data Quality Objective:	> 500	> 500	> 500	> 500	> 500	> 500	> 500	> 500	> 500	> 500	> 500	> 500	> 500	> 500	> 500
Does this meet DQO:	Yes	Yes	Yes	Yes	Yes	Yes	Yes	Yes	Yes	Yes	Yes	Yes	Yes	Yes	Yes
Standard Deviation of Penetration for Each Channel :	0.05	0.06	0.06	0.06	0.05	0.05	0.06	0.07	0.06	0.06	0.06	0.07	0.16	0.12	0.09
Data Quality Objective:	<0.10	<0.10	<0.10	<0.10	<0.10	<0.10	<0.10	<0.10	<0.10	<0.10	<0.10	<0.30	<0.30	<0.30	<0.30
Does this meet DQO:	Yes	Yes	Yes	Yes	Yes	Yes	Yes	Yes	Yes	Yes	Yes	Yes	Yes	Yes	Yes

Maximum observed particle concentration (#/cc): 15.8
 Data Quality Objective: max. allowable conc. (#/cc): < 23
 Does this meet the DQO: Yes, (applies to all channels)

US EPA ARCHIVE DOCUMENT

Test No. 09089902
 Arrestor
 Liquid-Phase

Particle Counts per Indicated OPC Channel (1-Minute Samples @ 7.1 L/min)

OPC Channel Number	1	2	3	4	5	6	7	8	9	10	11	12	13	14	15
Min. Diam. (um)	0.28	0.37	0.47	0.52	0.66	0.94	1.22	1.51	1.88	2.07	2.83	3.77	4.71	5.18	6.60
Max. Diam. (um)	0.37	0.47	0.52	0.66	0.94	1.22	1.51	1.88	2.07	2.83	3.77	4.71	5.18	6.60	9.43
Geo. Mean Diam (um)	0.32	0.42	0.49	0.58	0.78	1.07	1.36	1.68	1.97	2.42	3.26	4.21	4.94	5.85	7.89
ENTER DATA BELOW															
U. Bckgrnd	1	01	09-08-1999	07:46:22	01:00	0	0	0	0	0	0	0	0	0	0
Upstream	1	01	09-08-1999	07:52:57	01:00	9607	14730	5263	9755	14690	10100	16640	13360	2884	7054
Upstream	1	01	09-08-1999	07:55:27	01:00	9327	14440	5106	9528	14540	9977	16730	13260	2830	6884
Upstream	1	01	09-08-1999	07:57:57	01:00	9189	14180	5016	9098	13720	9545	15670	12480	2770	6646
Upstream	1	01	09-08-1999	08:00:27	01:00	8818	13780	4852	8745	13570	9311	15560	12230	2638	6562
Upstream	1	01	09-08-1999	08:02:57	01:00	8788	13570	4766	8906	13430	9267	15310	12310	2646	6400
Upstream	1	01	09-08-1999	08:05:27	01:00	9191	14240	5051	9115	14250	9529	15910	12570	2859	6675
Upstream	1	01	09-08-1999	08:07:57	01:00	7882	12520	4348	7804	11900	8542	13760	10280	2361	5499
Upstream	1	01	09-08-1999	08:10:27	01:00	9549	14760	5271	9660	14390	10390	16400	12340	2761	6570
Upstream	1	01	09-08-1999	08:12:57	01:00	9314	14830	5136	9266	14320	10040	16360	12000	2686	6467
Upstream	1	01	09-08-1999	08:15:27	01:00	9280	14330	5086	9101	13710	9878	15820	11620	2636	6174
U. Bckgrnd	1	01	09-08-1999	08:23:19	01:00	0	0	0	0	0	0	1	0	0	0
ENTER DATA BELOW															
D. Bckgrnd	2	01	09-08-1999	07:47:37	01:00	0	0	0	0	0	1	0	0	0	0
Downstream	2	01	09-08-1999	07:54:12	01:00	9353	14070	5034	9507	14200	9539	15390	11510	2129	4199
Downstream	2	01	09-08-1999	07:56:42	01:00	8979	14110	4839	9013	13670	9290	15020	10700	2076	3870
Downstream	2	01	09-08-1999	07:59:12	01:00	8563	13360	4661	8756	13220	8655	14440	10310	2057	3903
Downstream	2	01	09-08-1999	08:01:42	01:00	8707	12980	4500	8654	12840	8597	14160	10350	2141	3775
Downstream	2	01	09-08-1999	08:04:12	01:00	9059	13720	4797	8930	13540	9126	14700	10550	2081	3996
Downstream	2	01	09-08-1999	08:06:42	01:00	8969	13640	4912	9103	13540	9206	14740	11180	2076	4136
Downstream	2	01	09-08-1999	08:09:12	01:00	9471	14260	5218	9340	14120	9867	15430	10590	2029	3901
Downstream	2	01	09-08-1999	08:11:42	01:00	9217	14330	4972	9104	13840	9475	15060	10170	1982	3824
Downstream	2	01	09-08-1999	08:14:12	01:00	9395	14380	5211	9191	13940	9609	15180	10380	2051	3793
Downstream	2	01	09-08-1999	08:16:42	01:00	9249	14150	4700	8731	13390	9498	14720	9770	2013	3715
D. Bckgrnd	2	01	09-08-1999	08:24:34	01:00	0	0	0	0	0	0	0	0	0	0
Meas. Penetration	1.00	0.98	0.98	0.99	0.98	0.96	0.94	0.86	0.76	0.60	0.32	0.10	0.02	0.01	0.00
P100 correction values	1.01	1.01	1.01	1.01	1.01	1.00	1.01	1.02	1.02	1.01	1.00	0.93	0.86	0.90	0.63
Corrected Penetration	0.99	0.97	0.97	0.98	0.98	0.96	0.93	0.85	0.75	0.60	0.32	0.10	0.03	0.01	0.00
Corrected Efficiency (%)	1	3	3	2	2	4	7	15	25	40	68	90	97	99	100
Data Acceptance Criteria:															
Total Challenge Counts for Each Channel:	90945	141380	49895	90978	138520	96579	158160	122450	27071	64931	39062	10140	1569	2396	1377
Data Quality Objective:	> 500	> 500	> 500	> 500	> 500	> 500	> 500	> 500	> 500	> 500	> 500	> 500	> 500	> 500	> 500
Does this meet DQO:	Yes	Yes	Yes	Yes	Yes	Yes	Yes	Yes	Yes	Yes	Yes	Yes	Yes	Yes	Yes
Standard Deviation of Penetration for Each Channel :	0.06	0.06	0.07	0.07	0.07	0.07	0.06	0.07	0.05	0.05	0.04	0.02	0.01	0.01	0.00
Data Quality Objective:	<0.10	<0.10	<0.10	<0.10	<0.10	<0.10	<0.10	<0.10	<0.10	<0.10	<0.30	<0.30	<0.30	<0.30	<0.30
Does this meet DQO:	Yes	Yes	Yes	Yes	Yes	Yes	Yes	Yes	Yes	Yes	Yes	Yes	Yes	Yes	Yes
Maximum observed particle concentration (#/cc):	15.5														
Data Quality Objective: max. allowable conc. (#/cc):	< 23														
Does this meet the DQO:	Yes, (applies to all channels)														

US EPA ARCHIVE DOCUMENT

Test No. 09089903
 No Filter
 Liquid-Phase

Particle Counts per Indicated OPC Channel (1-Minute Samples @ 7.1 L/min)

OPC Channel Number	1	2	3	4	5	6	7	8	9	10	11	12	13	14	15
Min. Diam. (um)	0.28	0.37	0.47	0.52	0.66	0.94	1.22	1.51	1.88	2.07	2.83	3.77	4.71	5.18	6.60
Max. Diam. (um)	0.37	0.47	0.52	0.66	0.94	1.22	1.51	1.88	2.07	2.83	3.77	4.71	5.18	6.60	9.43
Geo. Mean Diam (um)	0.32	0.42	0.49	0.58	0.78	1.07	1.36	1.68	1.97	2.42	3.26	4.21	4.94	5.85	7.89

ENTER DATA BELOW

U. Bckgrnd	1 01 09-08-1999 08:36:12 01:00	0	0	0	0	0	0	0	0	0	0	0	0	0	0	
Upstream	1 01 09-08-1999 08:49:02 01:00	9139	14150	4965	8967	13480	9823	15740	11750	2535	6408	3704	991	142	264	120
Upstream	1 01 09-08-1999 08:51:32 01:00	9235	13940	5008	9107	13730	9760	15630	11770	2600	6372	3690	971	153	251	110
Upstream	1 01 09-08-1999 08:54:02 01:00	9516	14710	4960	9152	13780	9839	16070	12110	2680	6587	3757	1008	132	244	118
Upstream	1 01 09-08-1999 08:56:32 01:00	9784	14940	5275	9685	14430	10200	16610	12300	2672	6530	3819	1026	156	239	104
Upstream	1 01 09-08-1999 08:59:02 01:00	9996	14880	5310	9628	14680	10400	16670	12480	2890	6725	3934	1026	150	201	135
Upstream	1 01 09-08-1999 09:01:32 01:00	9858	15220	5334	9656	14590	10510	17000	12220	2792	6677	3872	1057	179	224	122
Upstream	1 01 09-08-1999 09:04:02 01:00	9502	14500	5050	9688	14340	9756	16000	12790	2852	6669	4091	1125	175	270	144
Upstream	1 01 09-08-1999 09:06:32 01:00	9644	14650	5361	9419	14580	9894	16070	13120	2927	6918	4273	1113	183	264	144
Upstream	1 01 09-08-1999 09:09:02 01:00	9603	14840	5062	9602	14380	9812	16540	13100	2940	7006	4282	1142	180	250	135
Upstream	1 01 09-08-1999 09:11:32 01:00	9980	15180	5315	10010	15120	10300	17140	13460	3007	7100	4265	1197	176	279	137
U. Bckgrnd	1 01 09-08-1999 09:19:39 01:00	0	0	0	0	0	0	0	0	0	0	0	0	0	0	0

ENTER DATA BELOW

D. Bckgrnd	2 01 09-08-1999 08:37:27 01:00	0	0	0	0	0	0	0	0	0	0	0	0	0	0	
Downstream	2 01 09-08-1999 08:50:17 01:00	9138	14140	5008	9259	13620	9711	15810	11800	2706	6411	3648	905	128	195	85
Downstream	2 01 09-08-1999 08:52:47 01:00	9144	14060	4968	9144	13720	9834	15940	11670	2608	6414	3678	909	134	207	84
Downstream	2 01 09-08-1999 08:55:17 01:00	9708	15170	5260	9511	14490	10170	16640	12380	2783	6645	3974	1011	137	187	85
Downstream	2 01 09-08-1999 08:57:47 01:00	9835	15180	5316	9601	14550	10350	16800	12410	2807	6886	3838	1006	136	179	77
Downstream	2 01 09-08-1999 09:00:17 01:00	10170	15170	5293	9808	14990	10510	17140	12560	2804	6822	4008	1015	132	192	87
Downstream	2 01 09-08-1999 09:02:47 01:00	10160	15860	5350	9735	15060	10460	17160	12600	2833	6908	3925	988	149	211	72
Downstream	2 01 09-08-1999 09:05:17 01:00	9810	14780	5321	9602	14850	10030	16870	13570	2952	7025	4214	1044	155	221	115
Downstream	2 01 09-08-1999 09:07:47 01:00	9628	14370	5012	9407	14160	9692	16340	12990	2845	6830	4091	1051	169	194	125
Downstream	2 01 09-08-1999 09:10:17 01:00	9782	14950	5240	9561	14520	10110	16620	13510	3008	7002	4235	1036	163	269	105
Downstream	2 01 09-08-1999 09:12:47 01:00	9723	14840	5080	9693	14800	10240	16570	13230	2880	6922	4137	1088	150	236	119
D. Bckgrnd	2 01 09-08-1999 09:20:54 01:00	0	0	0	0	0	0	0	0	0	0	0	0	0	0	0

Meas. Penetration	1.01	1.01	1.00	1.00	1.01	1.01	1.01	1.01	1.01	1.01	1.00	0.94	0.89	0.84	0.75
P100 correction values	1.00	1.00	1.00	1.00	1.00	1.00	1.00	1.00	1.00	1.00	1.00	1.00	1.00	1.00	1.00
Corrected Penetration	1.01	1.01	1.00	1.00	1.01	1.01	1.01	1.01	1.01	1.01	1.00	0.94	0.89	0.84	0.75
Corrected Efficiency (%)	-1	-1	0	0	-1	-1	-1	-1	-1	-1	0	6	11	16	25

Data Acceptance Criteria:

Total Challenge Counts for Each Channel:	96257	147010	51640	94914	143110	100294	163470	125100	27895	66992	39687	10656	1626	2486	1269
Data Quality Objective:	> 500	> 500	> 500	> 500	> 500	> 500	> 500	> 500	> 500	> 500	> 500	> 500	> 500	> 500	> 500
Does this meet DQO:	Yes	Yes	Yes	Yes	Yes	Yes	Yes	Yes	Yes	Yes	Yes	Yes	Yes	Yes	Yes

Standard Deviation of Penetration for Each Channel :	0.05	0.05	0.04	0.04	0.05	0.04	0.04	0.07	0.07	0.05	0.08	0.09	0.13	0.13	0.17
Data Quality Objective:	<0.10	<0.10	<0.10	<0.10	<0.10	<0.10	<0.10	<0.10	<0.10	<0.10	<0.30	<0.30	<0.30	<0.30	<0.30
Does this meet DQO:	Yes	Yes	Yes	Yes	Yes	Yes	Yes	Yes	Yes	Yes	Yes	Yes	Yes	Yes	Yes

Maximum observed particle concentration (#/cc):	15.9
Data Quality Objective: max. allowable conc. (#/cc):	< 23
Does this meet the DQO:	Yes, (applies to all channels)

Test No. 09089904
 Arrestor
 Liquid-Phase

Particle Counts per Indicated OPC Channel (1-Minute Samples @ 7.1 L/min)

OPC Channel Number		1	2	3	4	5	6	7	8	9	10	11	12	13	14	15
Min. Diam. (um)		0.28	0.37	0.47	0.52	0.66	0.94	1.22	1.51	1.88	2.07	2.83	3.77	4.71	5.18	6.60
Max. Diam. (um)		0.37	0.47	0.52	0.66	0.94	1.22	1.51	1.88	2.07	2.83	3.77	4.71	5.18	6.60	9.43
Geo. Mean Diam (um)		0.32	0.42	0.49	0.58	0.78	1.07	1.36	1.68	1.97	2.42	3.26	4.21	4.94	5.85	7.89
ENTER DATA BELOW																
U. Bckgrnd	1 01 09-08-1999 09:32:40 01:00	0	0	0	0	0	0	0	0	0	0	0	0	0	0	0
Upstream	1 01 09-08-1999 09:40:38 01:00	9477	14700	5165	9530	14050	10220	16630	12650	2766	6712	4101	1020	154	242	122
Upstream	1 01 09-08-1999 09:43:08 01:00	9579	14340	4914	9215	14150	9858	16000	12120	2723	6601	3821	1010	154	207	124
Upstream	1 01 09-08-1999 09:45:38 01:00	9664	14850	5098	9405	14180	10100	16720	12850	2819	6612	4048	1004	163	253	120
Upstream	1 01 09-08-1999 09:48:08 01:00	9687	14550	5235	9158	14380	10050	16390	12290	2754	6743	3842	1004	137	226	128
Upstream	1 01 09-08-1999 09:50:38 01:00	10330	15780	5486	10020	15240	10490	17270	13760	2942	7206	4213	1162	199	273	154
Upstream	1 01 09-08-1999 09:53:08 01:00	10100	15020	5233	9878	14740	10150	17200	13420	2993	7111	4296	1134	181	279	175
Upstream	1 01 09-08-1999 09:55:38 01:00	9995	15490	5271	9918	15100	10470	17110	13430	2954	7086	4211	1120	180	299	150
Upstream	1 01 09-08-1999 09:58:08 01:00	9752	14630	4996	9522	14350	9787	16210	13120	2883	6741	4059	1068	151	264	142
Upstream	1 01 09-08-1999 10:00:38 01:00	9364	14550	5204	9247	14060	9767	16170	12960	2661	6818	3995	1101	188	238	149
Upstream	1 01 09-08-1999 10:03:08 01:00	9222	14120	4974	9287	14090	9761	16070	12950	2811	6839	4122	1124	173	269	139
U. Bckgrnd	1 01 09-08-1999 10:18:54 01:00	0	0	0	0	0	0	0	0	0	0	0	0	0	0	0
ENTER DATA BELOW																
D. Bckgrnd	2 01 09-08-1999 09:33:55 01:00	4	6	1	0	1	3	1	2	0	0	1	0	0	0	0
Downstream	2 01 09-08-1999 09:41:53 01:00	9493	14430	4979	9282	13800	9568	15190	10200	2036	3989	1134	71	3	1	2
Downstream	2 01 09-08-1999 09:44:23 01:00	9551	14210	5033	9134	13470	9513	15240	10340	1965	3838	1113	73	0	4	0
Downstream	2 01 09-08-1999 09:46:53 01:00	9327	14280	4920	9107	13580	9352	15210	10510	2058	3898	1202	87	5	6	0
Downstream	2 01 09-08-1999 09:49:23 01:00	9947	15150	5306	9547	14420	9889	16030	10990	2120	4165	1274	100	5	4	1
Downstream	2 01 09-08-1999 09:51:53 01:00	10010	15290	5219	9929	14610	9821	16130	11780	2249	4503	1459	103	2	6	0
Downstream	2 01 09-08-1999 09:54:23 01:00	9741	14960	5287	9894	14540	9749	16120	11610	2194	4474	1407	109	6	2	0
Downstream	2 01 09-08-1999 09:56:53 01:00	9884	14660	5189	9677	14460	9880	15670	11360	2284	4377	1363	102	3	5	0
Downstream	2 01 09-08-1999 09:59:23 01:00	9815	14630	4985	9366	14080	9493	15480	11380	2135	4206	1356	92	4	0	0
Downstream	2 01 09-08-1999 10:01:53 01:00	9507	14230	5072	9332	14040	9568	15610	11150	2201	4223	1375	102	2	1	0
Downstream	2 01 09-08-1999 10:04:23 01:00	9298	14050	4961	9180	13780	9535	15310	11580	2176	4146	1407	93	4	2	0
D. Bckgrnd	2 01 09-08-1999 10:20:09 01:00	0	0	0	0	0	0	1	0	0	0	0	0	0	0	0
Meas. Penetration		0.99	0.99	0.99	0.99	0.98	0.96	0.94	0.86	0.76	0.61	0.32	0.09	0.02	0.01	0.00
P100 correction values		1.01	1.01	1.00	1.00	1.01	1.01	1.01	1.01	1.01	1.01	1.00	0.94	0.89	0.84	0.75
Corrected Penetration		0.99	0.98	0.98	0.99	0.96	0.95	0.93	0.85	0.75	0.60	0.32	0.09	0.02	0.01	0.00
Corrected Efficiency (%)		1	2	2	1	4	5	7	15	25	40	68	91	98	99	100
Data Acceptance Criteria:																
Total Challenge Counts for Each Channel:		97170	148030	51576	95180	144340	100653	165770	129550	28306	68469	40708	10747	1680	2550	1403
Data Quality Objective:		> 500	> 500	> 500	> 500	> 500	> 500	> 500	> 500	> 500	> 500	> 500	> 500	> 500	> 500	> 500
Does this meet DQO:		Yes	Yes	Yes	Yes	Yes	Yes	Yes	Yes	Yes	Yes	Yes	Yes	Yes	Yes	Yes
Standard Deviation of Penetration for Each Channel :		0.04	0.04	0.04	0.05	0.04	0.03	0.04	0.06	0.05	0.04	0.03	0.01	0.01	0.01	0.00
Data Quality Objective:		<0.10	<0.10	<0.10	<0.10	<0.10	<0.10	<0.10	<0.10	<0.10	<0.10	<0.30	<0.30	<0.30	<0.30	<0.30
Does this meet DQO:		Yes	Yes	Yes	Yes	Yes	Yes	Yes	Yes	Yes	Yes	Yes	Yes	Yes	Yes	Yes
Maximum observed particle concentration (#/cc):		16.2														
Data Quality Objective: max. allowable conc. (#/cc):		< 23														
Does this meet the DQO:		Yes, (applies to all channels)														

US EPA ARCHIVE DOCUMENT

Test No. 09089905

No Filter
Liquid-Phase

Particle Counts per Indicated OPC Channel (1-Minute Samples @ 7.1 L/min)

OPC Channel Number	1	2	3	4	5	6	7	8	9	10	11	12	13	14	15
Min. Diam. (um)	0.28	0.37	0.47	0.52	0.66	0.94	1.22	1.51	1.88	2.07	2.83	3.77	4.71	5.18	6.60
Max. Diam. (um)	0.37	0.47	0.52	0.66	0.94	1.22	1.51	1.88	2.07	2.83	3.77	4.71	5.18	6.60	9.43
Geo. Mean Diam (um)	0.32	0.42	0.49	0.58	0.78	1.07	1.36	1.68	1.97	2.42	3.26	4.21	4.94	5.85	7.89

ENTER DATA BELOW

U. Bckgrnd	1	01	09-08-1999	10:34:13	01:00	0	0	0	0	0	0	0	0	0	0	0				
Upstream	1	01	09-08-1999	10:43:15	01:00	9323	14340	4983	9636	14530	9964	16410	13120	2850	7049	4189	1138	154	263	158
Upstream	1	01	09-08-1999	10:45:45	01:00	9291	14480	5066	9467	14600	9741	16470	13490	2919	7069	4214	1214	175	279	142
Upstream	1	01	09-08-1999	10:48:15	01:00	9411	14570	5106	9522	14200	9889	16430	13460	2838	6928	4214	1138	160	272	156
Upstream	1	01	09-08-1999	10:50:45	01:00	9384	14790	5178	9511	14470	10010	16690	13770	2817	7030	4296	1118	187	229	158
Upstream	1	01	09-08-1999	10:53:15	01:00	9450	14570	5053	9565	14310	9867	16600	13390	2887	7018	4345	1119	161	270	141
Upstream	1	01	09-08-1999	10:55:45	01:00	9744	15100	5362	9934	15130	10360	17080	14250	3051	7143	4474	1263	199	259	164
Upstream	1	01	09-08-1999	10:58:15	01:00	8257	12680	4636	8171	12610	8894	14530	11020	2399	6012	3408	908	138	219	109
Upstream	1	01	09-08-1999	11:00:45	01:00	9425	14660	5158	9381	14320	10070	16220	12410	2631	6739	3842	1067	169	203	127
Upstream	1	01	09-08-1999	11:03:15	01:00	9347	14810	5172	9451	14330	10100	16570	12180	2678	6646	3818	993	154	244	114
Upstream	1	01	09-08-1999	11:05:45	01:00	9669	15000	5343	9721	14620	10290	16880	12300	2786	6595	3807	994	149	210	118
U. Bckgrnd	1	01	09-08-1999	11:13:40	01:00	0	0	0	0	0	0	0	0	0	0	0	0	0	0	0

ENTER DATA BELOW

D. Bckgrnd	2	01	09-08-1999	10:35:28	01:00	0	0	0	0	0	0	0	0	0	0	0	0	0	0	0
Downstream	2	01	09-08-1999	10:44:30	01:00	9256	14290	5040	9307	14350	9936	16280	13360	2953	6798	3938	1023	143	185	93
Downstream	2	01	09-08-1999	10:47:00	01:00	9140	14300	4934	9323	14140	9706	16140	13360	2914	6983	4256	1126	152	234	98
Downstream	2	01	09-08-1999	10:49:30	01:00	9262	14140	5056	9393	14220	9684	16430	13270	2882	6846	4234	1057	159	196	96
Downstream	2	01	09-08-1999	10:52:00	01:00	9309	14580	5166	9679	14540	9752	16420	13350	3011	7033	4219	1046	137	208	101
Downstream	2	01	09-08-1999	10:54:30	01:00	9414	14510	5118	9570	14410	9843	16560	13530	2980	6935	4103	1101	178	216	103
Downstream	2	01	09-08-1999	10:57:00	01:00	9292	14220	4989	9613	14440	9930	16340	13730	2931	6974	4247	1111	150	220	101
Downstream	2	01	09-08-1999	10:59:30	01:00	9353	14370	5161	9341	14150	10170	16500	12400	2799	6761	3821	983	141	176	90
Downstream	2	01	09-08-1999	11:02:00	01:00	9526	14800	5199	9498	14380	10000	16760	12290	2833	6664	3897	962	151	205	85
Downstream	2	01	09-08-1999	11:04:30	01:00	9771	15370	5343	9572	14850	10710	17210	12630	2814	6798	3922	966	119	189	101
Downstream	2	01	09-08-1999	11:07:00	01:00	9793	15520	5558	9639	14870	10640	17240	12750	2876	6912	3947	974	140	207	94
D. Bckgrnd	2	01	09-08-1999	11:14:55	01:00	0	0	0	1	0	0	0	0	0	0	0	0	0	0	0

Meas. Penetration	1.01	1.01	1.01	1.01	1.01	1.01	1.01	1.01	1.01	1.04	1.01	1.00	0.94	0.89	0.83	0.69
P100 correction values	1.00	1.00	1.00	1.00	1.00	1.00	1.00	1.00	1.00	1.00	1.00	1.00	1.00	1.00	1.00	1.00
Corrected Penetration	1.01	1.01	1.01	1.01	1.01	1.01	1.01	1.01	1.01	1.04	1.01	1.00	0.94	0.89	0.83	0.69
Corrected Efficiency (%)	-1	-1	-1	-1	-1	-1	-1	-1	-1	-4	-1	0	6	11	17	31

Data Acceptance Criteria:

Total Challenge Counts for Each Channel:	93301	145000	51057	94359	143120	99185	163880	129390	27856	68229	40607	10952	1646	2448	1387
Data Quality Objective:	> 500	> 500	> 500	> 500	> 500	> 500	> 500	> 500	> 500	> 500	> 500	> 500	> 500	> 500	> 500
Does this meet DQO:	Yes	Yes	Yes	Yes	Yes	Yes	Yes	Yes	Yes	Yes	Yes	Yes	Yes	Yes	Yes

Standard Deviation of Penetration for Each Channel :	0.05	0.06	0.05	0.05	0.05	0.06	0.05	0.08	0.07	0.05	0.09	0.11	0.14	0.12	0.11
Data Quality Objective:	<0.10	<0.10	<0.10	<0.10	<0.10	<0.10	<0.10	<0.10	<0.10	<0.10	<0.30	<0.30	<0.30	<0.30	<0.30
Does this meet DQO:	Yes	Yes	Yes	Yes	Yes	Yes	Yes	Yes	Yes	Yes	Yes	Yes	Yes	Yes	Yes

Maximum observed particle concentration (#/cc):	16.0
Data Quality Objective: max. allowable conc. (#/cc):	< 23
Does this meet the DQO:	Yes, (applies to all channels)

Test No. 09089907
 Arrestor
 Liquid-Phase

Particle Counts per Indicated OPC Channel (1-Minute Samples @ 7.1 L/min)

OPC Channel Number	1	2	3	4	5	6	7	8	9	10	11	12	13	14	15
Min. Diam. (um)	0.28	0.37	0.47	0.52	0.66	0.94	1.22	1.51	1.88	2.07	2.83	3.77	4.71	5.18	6.60
Max. Diam. (um)	0.37	0.47	0.52	0.66	0.94	1.22	1.51	1.88	2.07	2.83	3.77	4.71	5.18	6.60	9.43
Geo. Mean Diam (um)	0.32	0.42	0.49	0.58	0.78	1.07	1.36	1.68	1.97	2.42	3.26	4.21	4.94	5.85	7.89

ENTER DATA BELOW

U. Bckgrnd	1 01 09-08-1999 12:45:15 01:00	0	0	0	0	0	0	0	0	0	0	0	0	0	0
Upstream	1 01 09-08-1999 12:53:05 01:00	9905	15160	5426	9688	14730	10420	16990	12590	2876	6945	3947	1034	160	259
Upstream	1 01 09-08-1999 12:55:35 01:00	9741	15130	5334	9858	14850	10410	17260	12880	2873	6971	4060	1079	159	262
Upstream	1 01 09-08-1999 12:58:05 01:00	9497	14950	5102	9589	14310	10140	16650	12270	2698	6782	3867	1051	161	249
Upstream	1 01 09-08-1999 13:00:35 01:00	9498	14490	5125	9368	14190	9974	16660	12340	2717	6738	3998	1031	165	225
Upstream	1 01 09-08-1999 13:03:05 01:00	9376	14390	5134	9476	14170	9822	16390	12530	2804	6644	3985	1114	158	240
Upstream	1 01 09-08-1999 13:05:35 01:00	9556	14830	5195	9419	14470	10210	16810	12610	2832	6727	4133	1010	174	249
Upstream	1 01 09-08-1999 13:08:05 01:00	9080	13650	4769	8983	13440	9366	15390	12460	2713	6514	3984	1087	158	262
Upstream	1 01 09-08-1999 13:10:35 01:00	9221	14580	5211	9551	14270	10040	16310	12980	2905	6906	4197	1055	175	260
Upstream	1 01 09-08-1999 13:13:05 01:00	9220	14250	4940	9304	14010	9657	16180	12640	2794	6717	4072	1076	147	266
Upstream	1 01 09-08-1999 13:15:35 01:00	9355	14360	4918	9300	14060	9586	16040	12900	2815	6897	4173	1100	190	249
U. Bckgrnd	1 01 09-08-1999 13:23:31 01:00	0	0	0	0	0	0	0	0	0	0	0	0	0	0

ENTER DATA BELOW

D. Bckgrnd	2 01 09-08-1999 12:46:30 01:00	0	1	0	0	0	0	0	0	0	0	0	0	0	0
Downstream	2 01 09-08-1999 12:54:20 01:00	9722	14860	5325	9513	14220	10130	15960	11090	2174	4546	1523	147	6	7
Downstream	2 01 09-08-1999 12:56:50 01:00	9480	14530	5122	9430	14100	9662	15710	10880	2266	4408	1493	142	8	5
Downstream	2 01 09-08-1999 12:59:20 01:00	9281	14410	5105	9385	14260	9632	15400	10750	2196	4342	1532	137	9	12
Downstream	2 01 09-08-1999 13:01:50 01:00	9331	14380	5021	9143	13800	9595	15450	11080	2146	4441	1574	144	9	9
Downstream	2 01 09-08-1999 13:04:20 01:00	9433	14430	5062	9263	13850	9528	15220	11010	2133	4515	1551	141	5	7
Downstream	2 01 09-08-1999 13:06:50 01:00	9612	14660	5122	9290	14060	9899	15750	10770	2146	4472	1563	139	7	10
Downstream	2 01 09-08-1999 13:09:20 01:00	9481	14500	4994	9552	14200	9764	15660	11820	2417	4746	1930	172	12	7
Downstream	2 01 09-08-1999 13:11:50 01:00	9153	13840	4860	8936	13510	9313	15000	11380	2292	4553	1664	152	10	8
Downstream	2 01 09-08-1999 13:14:20 01:00	9379	14300	5021	9325	14210	9664	15470	11910	2229	4804	1790	164	15	5
Downstream	2 01 09-08-1999 13:16:50 01:00	9438	14150	5018	9357	13990	9466	15420	11550	2236	4702	1721	175	14	7
D. Bckgrnd	2 01 09-08-1999 13:24:46 01:00	0	0	0	0	0	0	0	0	0	0	0	0	0	0

Meas. Penetration	1.00	0.99	0.99	0.99	0.98	0.97	0.94	0.89	0.79	0.67	0.40	0.14	0.06	0.03	0.00
P100 correction values	1.01	1.01	1.01	1.01	1.01	1.01	1.01	1.01	1.04	1.01	1.00	0.94	0.89	0.83	0.69
Corrected Penetration	0.99	0.98	0.98	0.98	0.98	0.96	0.93	0.88	0.76	0.67	0.40	0.15	0.06	0.04	0.01
Corrected Efficiency (%)	1	2	2	2	2	4	7	12	24	33	60	85	94	96	99

Data Acceptance Criteria:

Total Challenge Counts for Each Channel:	94449	145790	51154	94536	142500	99625	164680	126200	28027	67841	40416	10637	1647	2521	1247
Data Quality Objective:	> 500	> 500	> 500	> 500	> 500	> 500	> 500	> 500	> 500	> 500	> 500	> 500	> 500	> 500	> 500
Does this meet DQO:	Yes	Yes	Yes	Yes	Yes	Yes	Yes	Yes	Yes	Yes	Yes	Yes	Yes	Yes	Yes

Standard Deviation of Penetration for Each Channel :	0.03	0.04	0.04	0.03	0.03	0.04	0.03	0.04	0.04	0.03	0.04	0.01	0.02	0.01	0.01
Data Quality Objective:	<0.10	<0.10	<0.10	<0.10	<0.10	<0.10	<0.10	<0.10	<0.10	<0.10	<0.30	<0.30	<0.30	<0.30	<0.30
Does this meet DQO:	Yes	Yes	Yes	Yes	Yes	Yes	Yes	Yes	Yes	Yes	Yes	Yes	Yes	Yes	Yes

Maximum observed particle concentration (#/cc):	15.7
Data Quality Objective: max. allowable conc. (#/cc):	< 23
Does this meet the DQO:	Yes, (applies to all channels)