

US EPA ARCHIVE DOCUMENT

Environmental Technology Verification Report

Paint Overspray Arrestor
Farr Company
Riga-Flo 200

US EPA ARCHIVE DOCUMENT

Prepared by



Research Triangle Institute

Under a Cooperative Agreement with



U.S. Environmental Protection Agency

ETV ✓ ETV ✓ ETV ✓

Environmental Technology Verification Report

Paint Overspray Arrestor

Farr Company Riga-Flo 200

Prepared by

Kathleen Owen
James Hanley
Jack Farmer

Air Pollution Control Technology Program
Research Triangle Institute
Research Triangle Park, NC 27709-2194

EPA Cooperative Agreement CR 826152-01-2

EPA Project Manager: Theodore G. Brna
Air Pollution Prevention and Control Division
National Risk Management Research Laboratory
Research Triangle Park, NC 27711

March 2000

Notice

This document was prepared by the Research Triangle Institute (RTI) under Cooperative Agreement No. CR826152-01-2 with the U.S. Environmental Protection Agency (EPA). The document has been subjected to EPA's peer and administrative reviews and has been approved for publication. Mention of corporation names, trade names, or commercial products does not constitute endorsement or recommendation for use of specific products.

Availability of Verification Statement and Report

Copies of the public Verification Statement and Verification Report are available from the following:

1. **Research Triangle Institute**

P.O. Box 12194
Research Triangle Park, NC 27709-2194

Web site: <http://etv.rti.org/apct/index.html>
or <http://www.epa.gov/etv> (*click on partners*)

2. **USEPA / APPCD**

MD-4
Research Triangle Park, NC 27711

Web site: <http://www.epa.gov/etv/library.htm> (*electronic copy*)
<http://www.epa.gov/ncepihom/>

Abstract

Paint overspray arrestors (POAs) were evaluated by the Air Pollution Control Technology (APCT) pilot of the Environmental Technology Verification (ETV) Program. The performance factor verified was the particle filtration efficiency as a function of size for particles smaller than 10 μm . The APCT ETV Program developed a generic verification protocol for testing filtration efficiency that is based on EPA Method 319. The protocol was developed by RTI, reviewed by a technical panel of experts, and approved by EPA. The protocol addresses several issues that Method 319 does not cover, including periodic testing, acquisition of POAs for testing, and product definition. A Test/Quality Assurance Plan was prepared which addresses the test procedure and quality assurance and quality control requirements for obtaining verification data of sufficient quantity and quality to satisfy the data quality objectives.

RTI performed tests on Farr's Riga-Flo 200 during the period October 5-8, 1999. Filter efficiencies were determined. For ready comparison, the filtration efficiency requirements of the National Emission Standards for Hazardous Air Pollutants (NESHAP) are tabulated with the test results. The results indicate that the Riga-Flo 200 met the NESHAP requirements for new and existing sources.

Table of Contents

	<u>Page</u>
Verification Statement	i
Notice	vii
Availability of Verification Statement and Report	viii
Abstract	ix
List of Figures	xi
List of Tables	xi
List of Abbreviations and Acronyms	xii
Acknowledgments	xiii
Section 1. Introduction	1
Section 2. Verification Test Description	1
2.1. Selection of Paint Overspray Arrestors for Testing	3
Section 3. Description of Arrestor	3
Section 4. Verification of Performance	3
4.1. Quality Assurance	3
4.2. Results	3
4.3. Limitations and Applications	4
Section 5. References	4
Appendix A. Description of the Test Rig and Methodology	A-1
Appendix B. Certificates of Calibration	B-1
Appendix C. Fractional Efficiency Data Sheets	C-1

List of Figures

	<u>Page</u>
Figure 1. Photograph of the Farr Riga-Flo 200 paint overspray arrestor	iii
Figure 2. Triplicate solid-phase particle removal efficiency curves for Farr Riga-Flo 200 paint overspray arrestor	7
Figure 3. Average of the solid-phase particle removal efficiency curves for Farr Riga-Flo 200 paint overspray arrestor.	8
Figure 4. Triplicate liquid-phase particle removal efficiency curves for Farr Riga-Flo 200 paint overspray arrestor	9
Figure 5. Average of the liquid-phase particle removal efficiency curves for Farr Riga-Flo 200 paint overspray arrestor	10
Figure A-1. Schematic illustration of the fractional efficiency test rig	A-2

List of Tables

Table 1. Existing Sources: Liquid-Phase Challenge Aerosol Particles	iv
Table 2. Existing Sources: Solid-Phase Challenge Aerosol Particles	iv
Table 3. New Sources: Liquid-Phase Challenge Aerosol Particles	iv
Table 4. New Sources: Solid-Phase Challenge Aerosol Particles	iv
Table 5. Test Series	2
Table 6. Summary of Solid-Phase Test Results	5
Table 7. Summary of Liquid-Phase Test Results	6
Table 8. Summary of Pressure Drop Measurements	11
Table A-1. Physical and Aerodynamic Sizing Channels for the Calibration and Test Aerosols	A-6

List of Abbreviations and Acronyms

APCT	Air Pollution Control Technology
APPCD	Air Pollution Prevention and Control Division
ASME	American Society of Mechanical Engineers
cfm	cubic feet per minute
cm	centimeter
Diam.	Diameter
DQO	data quality objective
EPA	U.S. Environmental Protection Agency
ETV	Environmental Technology Verification
fpm	feet per minute
ft ³	cubic foot
g	gram
Geo.	geometric
HEPA	high efficiency particulate air
ID	inside diameter
in.	inch
kW	kilowatt
L	liter
mL	milliliter
mm	millimeter
m/s	meters per second
NESHAP	National Emission Standards for Hazardous Air Pollutants
OPC	optical particle counter
Pa	pascal
POA	paint overspray arrestor
PSL	polystyrene latex
QA	quality assurance
RTI	Research Triangle Institute
s or sec	second
µm or um	micrometer

Acknowledgments

RTI acknowledges the support of all those who helped plan and conduct the verification activities. In particular, we would like to thank Ted Brna, EPA Project Manager, and Paul Groff, EPA Quality Manager, of EPA's National Risk Management Research Laboratory in Research Triangle Park, NC. Finally we would like to acknowledge the assistance and participation of Don Thornburg of Farr.

For more information on the Paint Overspray Arrestor Verification Testing, contact

James Hanley
Research Triangle Institute
P.O. Box 12194
Research Triangle Park, NC 27709-2194
(919) 541-5811

For more information on the Farr Riga-Flo 200, contact

Don Thornburg
Farr Company
2201 Park Place
El Segundo, CA 90245
(310) 727-6300

SECTION 1 INTRODUCTION

The U.S. Environmental Protection Agency (EPA) has created the Environmental Technology Verification (ETV) Program to facilitate the deployment of innovative or improved technologies through performance verification and information dissemination. The ETV Program is intended to assist and inform those involved in the design, distribution, permitting, and purchase of environmental technologies.

The U.S. EPA's partner in the Air Pollution Control Technology (APCT) Program is Research Triangle Institute (RTI). The APCT Program, with the full participation of the technology developer, develops plans, conducts tests, collects and analyzes data, and reports findings. The evaluations are conducted according to a rigorous protocol and quality assurance and quality control oversight. The APCT Program verifies the performance of commercial-ready technologies used to control air pollutant emissions, with an emphasis on technologies for controlling particulate matter, volatile organic compounds, nitrogen oxides, and hazardous air pollutants. The Program develops standardized verification protocols and test plans, conducts independent testing of technologies, and prepares verification test reports and statements for broad dissemination.

SECTION 2 VERIFICATION TEST DESCRIPTION

The paint overspray arrestor was tested in accordance with the APCT "Generic Verification Protocol for Paint Overspray Arrestors"¹ and the "Test/QA Plan for Paint Overspray Arrestors."² This protocol incorporates all requirements of EPA Method 319: Determination of Filtration Efficiency for Paint Overspray Arrestors. Method 319³ is part of the National Emission Standards for Hazardous Air Pollutants (NESHAP) for Aerospace Manufacturing and Rework Facilities.⁴ The protocol also includes requirements for quality management, quality assurance, procedures for product selection, auditing of the test laboratories, and reporting format.

Filtration efficiency was computed from aerosol concentrations measured upstream and downstream of an arrestor installed in a laboratory test rig. The aerosol concentrations upstream and downstream of the arrestors were measured with an aerosol analyzer that simultaneously counts and sizes the particles in the aerosol stream. The aerosol analyzer covered the particle diameter size range from 0.3 to 10 μm in a series of contiguous sizing channels. Each sizing channel covered a narrow range of particle diameters. For example, channel 1 covered from 0.3 to 0.4 μm , channel 2 from 0.4 to 0.5 μm , and channel 15 from 7 to 10 μm . By taking the ratio of the downstream to upstream particle counts for each channel, the filtration efficiency was computed for each of the sizing channels.

The upstream and downstream aerosol measurements were made while a test aerosol was injected into the air stream upstream of the arrestor [ambient aerosol is first removed from the upstream air with high efficiency particulate air (HEPA) filters on the inlet of the test rig]. This test aerosol spanned the particle

size range from 0.3 to 10 μm and provided a sufficient upstream concentration in each of the sizing channels to allow calculation of filtration efficiencies up to 99%.

The following series of tests were performed at a face velocity of 120 fpm (0.61 m/s):

- C Three arrestors were tested using a liquid-phase aerosol challenge,
- C Three arrestors were tested using a solid-phase aerosol challenge,
- C “No-filter” control tests (one performed prior to each arrestor test),
- C One HEPA filter control test, and
- C One reference filter control test.

The test series is exhibited in Table 5. Additional details on the test procedure are provided in Appendix A.

TABLE 5. TEST SERIES

RTI Test No.	TYPE OF TEST				Challenge Aerosol
	No-Filter	Test Arrestor	HEPA Filter	Reference Filter	
10059901	X				Solid-Phase
10059903				X	
10059904	X				
10059905		X			
10059906	X				
10069901		X			
10069902	X				
10069903		X			
10059902			X		
10089904	X				Liquid-Phase
10089905		X			
10089906	X				
10089907		X			
10089908	X				
10089909		X			

2.1 SELECTION OF PAINT OVERSPRAY ARRESTORS FOR TESTING

The test arrestors (Riga-Flo 200) were supplied to the test laboratory directly from the manufacturer's stock or normal production line with a letter from Don Thornburg, Engineering Manager, attesting that the arrestors comply fully with their Bill of Materials. The manufacturer supplied the test laboratory with 12 arrestors; the test laboratory randomly selected six for testing.

SECTION 3 DESCRIPTION OF ARRESTOR

As shown in Figure 1 (page iii), the Farr Riga-Flo 200 is a rigid cell arrestor with nominal dimensions of 24 x 24 x 12 in. (0.61 x 0.61 x 0.30 m). The arrestor has a metal frame, and the filter media color is yellow. The label is white with green printing and is about 5 x 8 in. (0.13 x 0.20 m) in size. The label includes the following information: Farr Riga-Flo-200, 24 x 24 x 12, Part No. 09026003. There is an arrow indicating flow direction.

SECTION 4 VERIFICATION OF PERFORMANCE

4.1 QUALITY ASSURANCE

The verification tests were conducted in accordance with an approved Test/Quality Assurance (QA) Plan.² The EPA Quality Manager conducted an independent assessment of the test laboratory in August 1999 and found that the test laboratory was being operated as specified in the Test/QA Plan. Additionally, APCT Quality Assurance staff have reviewed the results of this test and have found that the results meet data quality objectives in the Test/QA Plan. Certificates of Calibration for the optical particle counter and the airflow reference devices are provided in Appendix B.

4.2 RESULTS

Tables 6 and 7, and Figures 2 through 5, summarize the fractional filtration efficiency measurements for the solid- and liquid-phase tests. Upstream and downstream particle count data for each test are provided in Appendix C.

The initial (new condition) pressure drop across each test arrestor at the 120 fpm (0.61 m/s) test velocity [for a flowrate of 480 cfm (0.23 m³/s)] is shown in Table 8. The pressure drop across the tested arrestors ranged from 0.14 to 0.25 in. H₂O (35 to 62 Pa) for each of the six arrestors tested.

Tables 1-4 (page iv) present the filtration efficiency requirements of the Aerospace NESHAP and the corresponding efficiencies measured for the tested arrestor system. The test results indicate that the tested arrestor met the NESHAP requirements for new and existing sources.

4.3 LIMITATIONS AND APPLICATIONS

This verification report addresses two aspects of paint overspray arrestor performance: filtration efficiency and pressure drop. Users of this technology may wish to consider other performance parameters such as service life and cost when selecting a paint overspray arrestor for their use.

In accordance with the generic verification protocol, this Verification Statement is applicable to paint overspray arrestors manufactured between the publication date of the Verification Statement and 12 months thereafter.

As stated in Section 1.3 of Method 319³, "for a paint arrestor system or subsystem which has been tested by this method, adding additional filtration devices to the system or subsystem shall be assumed to result in an efficiency of at least that of the original system without additional testing."

SECTION 5 REFERENCES

1. Generic Verification Protocol for Paint Overspray Arrestors, Research Triangle Institute, Research Triangle Park, NC, August 1999.
2. Test/QA Plan for Paint Overspray Arrestors, Research Triangle Institute, Research Triangle Park, NC, February 1999.
3. Method 319: Determination of Filtration Efficiency for Paint Overspray Arrestors. *Code of Federal Regulations*, Appendix A to 40 CFR Part 63.
4. National Emission Standards for Hazardous Air Pollutants for Aerospace Manufacturing and Rework Facilities. *Code of Federal Regulations*, Title 40, Part 63, Subpart GG (40 CFR 63.741).

TABLE 6. SUMMARY OF SOLID-PHASE TEST RESULTS

Filtration Efficiency (%) at Indicated Size Range																
OPC Channel Number	1	2	3	4	5	6	7	8	9	10	11	12	13	14	15	
Min. Diam. (um)	0.45	0.59	0.73	0.80	1.02	1.44	1.86	2.28	2.85	3.13	4.25	5.66	7.07	7.77	9.88	
Max. Diam. (um)	0.59	0.73	0.80	1.02	1.44	1.86	2.28	2.85	3.13	4.25	5.66	7.07	7.77	9.88	14.10	
Geo. Mean Diam (um)	0.52	0.66	0.77	0.90	1.21	1.64	2.06	2.55	2.98	3.65	4.91	6.33	7.41	8.76	11.81	
Farr Riga-Flo 200																
Run #1	10059905	84	90	92	94	97	99	99	100	100	100	100	100	100	100	
Run #2	10069901	77	84	88	91	94	97	98	99	100	100	100	100	100	100	
Run #3	10069903	81	87	90	93	96	98	99	99	100	100	100	100	100	100	
Average		81	87	90	93	96	98	99	99	100	100	100	100	100	100	
Interpolated Efficiency Values (%) for Two-Stage Criteria:																
2.60 um (> 10% required):		99														
5.00 um (> 50% required):		100														
8.10 um (> 90% required):		100														
Interpolated Efficiency Values (%) for Three-Stage Criteria:																
0.70 um (> 75% required):		88														
1.10 um (> 85% required):		95														
2.50 um (> 95% required):		99														
HEPA Filter Control Test (applicable to both solid and liquid phase conditions)																
Run #1	10059902	100	100	100	100	100	100	100	100	100	100	100	100	100	100	
Reference Filter QA Test																
Current	10059903	0	0	2	3	4	4	8	10	10	14	24	36	48	58	78
Baseline	07279902	0	0	0	0	1	0	3	5	3	10	20	40	54	65	81
Difference		0	0	2	2	3	4	5	5	6	4	4	-3	-6	-7	-3
Acceptable (<10%)		yes	yes	yes	yes	yes	yes	yes	yes	yes	yes	yes	yes	yes	yes	yes
"No Filter" Control Tests																
Penetration For Each Size Range																
Run #1	10059904	1.00	1.00	0.99	1.01	1.01	1.00	1.01	1.01	1.00	1.02	1.00	1.00	0.98	0.99	0.97
Run #2	10059906	1.01	1.01	0.99	1.01	1.01	1.00	1.00	1.00	1.02	1.02	1.01	0.99	0.97	0.97	
Run #3	10069902	1.00	1.00	1.00	1.00	0.99	1.01	1.02	0.98	0.99	1.01	0.99	0.96	0.91	0.89	0.84

TABLE 7. SUMMARY OF LIQUID- PHASE TEST RESULTS

Filtration Efficiency (%) at Indicated Size Range																
OPC Channel Number	1	2	3	4	5	6	7	8	9	10	11	12	13	14	15	
Min. Diam. (um)	0.28	0.37	0.47	0.52	0.66	0.94	1.22	1.51	1.88	2.07	2.83	3.77	4.71	5.18	6.60	
Max. Diam. (um)	0.37	0.47	0.52	0.66	0.94	1.22	1.51	1.88	2.07	2.83	3.77	4.71	5.18	6.60	9.43	
Geo. Mean Diam (um)	0.32	0.418	0.49	0.58	0.78	1.07	1.36	1.68	1.97	2.42	3.26	4.21	4.94	5.85	7.89	
Farr Riga-Flo 200																
Run #1	10089905	72	80	83	86	91	95	97	99	99	99	99	100	100	100	100
Run #2	10089907	73	80	84	86	91	95	97	99	99	99	100	100	100	100	100
Run #3	10089909	77	84	87	89	93	96	97	98	98	98	98	99	99	99	99
Average		74	81	85	87	92	95	97	99	99	99	99	99	99	99	99
Interpolated Efficiency Values (%) for Two-Stage Criteria:																
2.20 um (> 10% required):	99															
4.10 um (> 50% required):	99															
5.70 um (> 90% required):	99															
Interpolated Efficiency Values (%) for Three-Stage Criteria:																
0.42 um (> 65% required):	82															
1.00 um (> 80% required):	95															
2.00 um (> 95% required):	99															
"No Filter" Control Tests																
		Penetration For Each Size Range														
Run #1	10089904	0.99	0.99	0.97	1.00	0.99	1.00	1.00	1.00	1.01	1.00	1.01	1.01	1.01	0.99	0.86
Run #2	10089906	1.00	0.99	1.00	1.00	1.00	1.00	1.00	1.00	1.01	1.01	1.01	1.01	0.99	0.96	0.81
Run #3	10089908	0.99	0.99	0.98	0.99	0.99	1.00	0.99	0.99	1.00	1.01	1.00	1.00	0.96	0.94	0.75

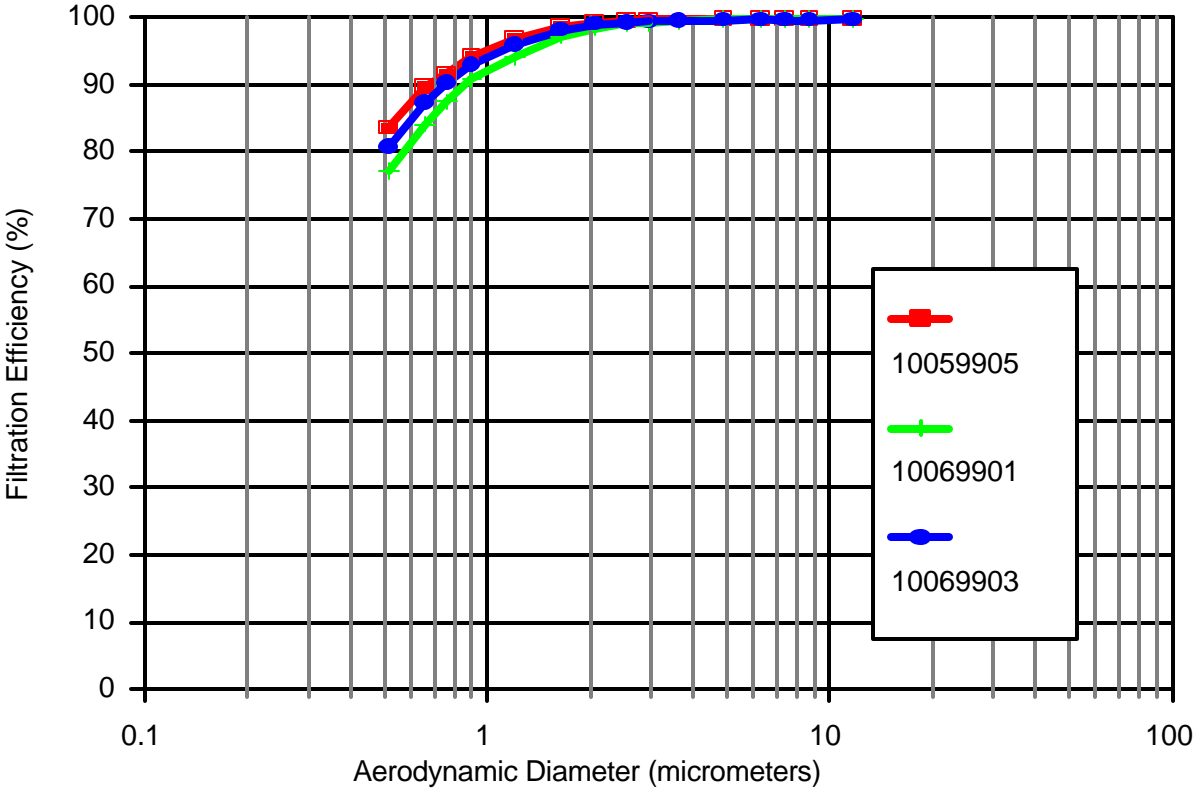

Figure 2. Triplicate solid-phase particle removal efficiency curves for the Farr Riga-Flo 200 paint overspray arrester.

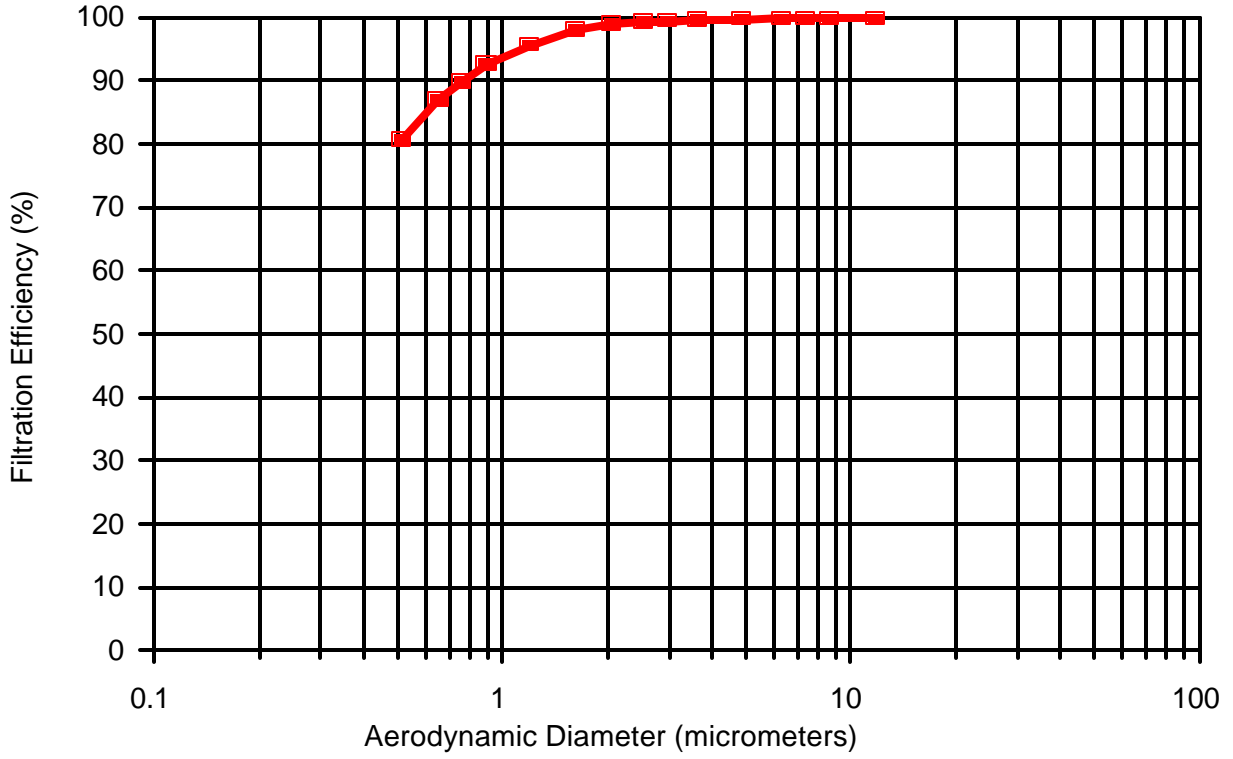

Figure 3. Average of the solid-phase particle removal efficiency curves for the Farr Riga-Flo 200 paint overspray arrester.

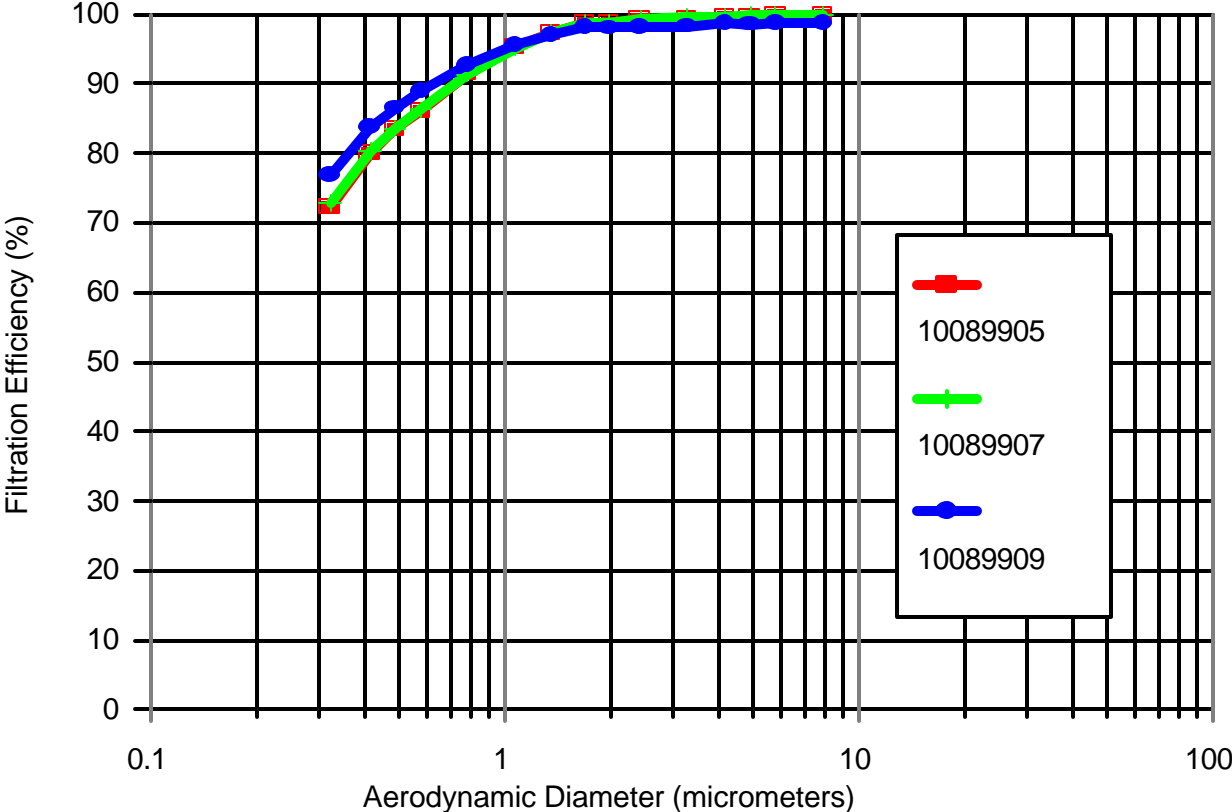

Figure 4. Triplicate liquid-phase particle removal efficiency curves for the Farr Riga-Flo 200 paint overspray arrestor.

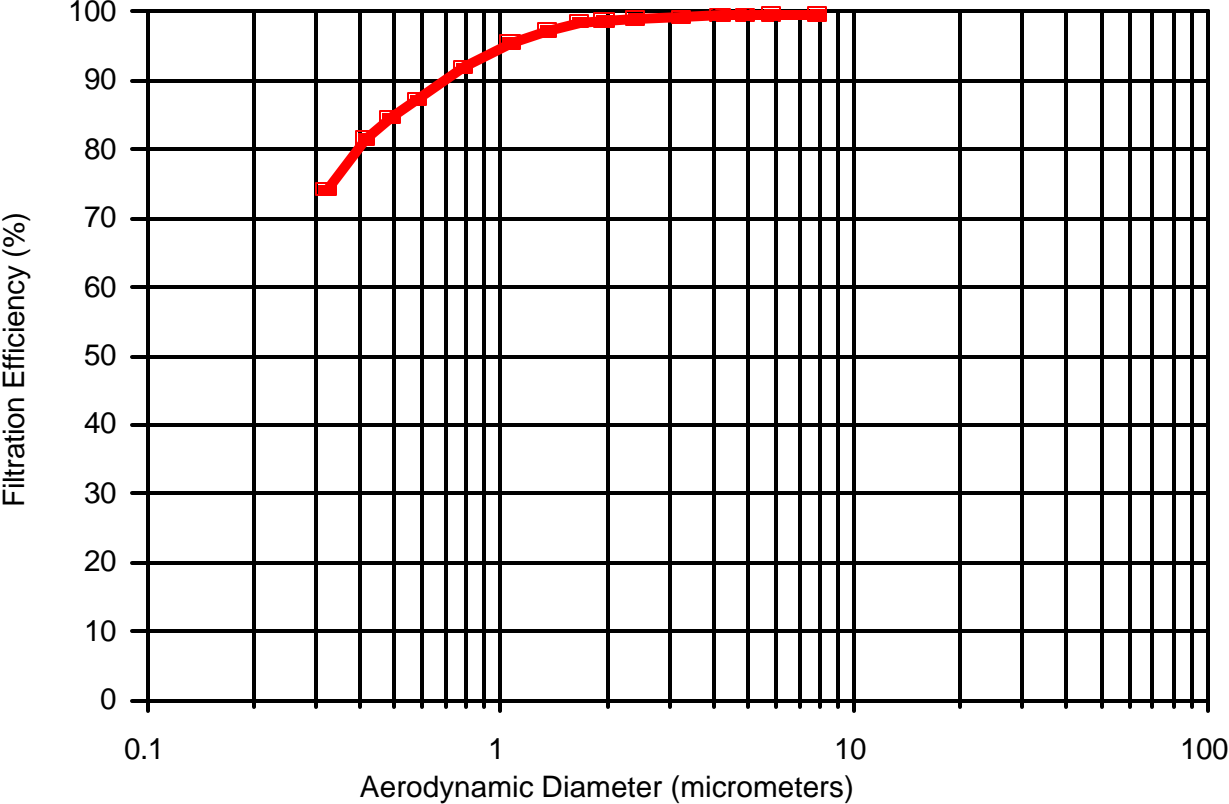

Figure 5. Average of the liquid-phase particle removal efficiency curves for the Farr Riga-Flo 200 paint overspray arrestor.

TABLE 8.
SUMMARY OF PRESSURE DROP MEASUREMENTS

Test No.	Initial Pressure Drop (inch H ₂ O)	Initial Pressure Drop (Pa)
10059905	0.25	62
10069901	0.15	37
10069903	0.24	60
10089905	0.15	37
10089907	0.14	35
10089909	0.19	47

Appendix A

DESCRIPTION OF THE TEST RIG AND METHODOLOGY

TEST DUCT

The tests were conducted in RTI's air cleaner test facility (Figure A-1). The test rig's ducting was primarily of 24 x 24 in. (0.61 x 0.61m) cross section and made of 14-gauge stainless steel. The blower is rated at 15 hp (11 kW) with a flow capacity of 3000 cfm (1.4 m³/s) at 13 in. H₂O (3200 Pa). The inlet and outlet filter banks consist of two 24 x 24 x 2 in. (0.61 x 0.61 x 0.05 m) prefilters and two 24 x 24 x 12 in. (0.61 x 0.61 x 0.30 m) high efficiency particulate air (HEPA) filters rated at 2000 cfm (0.9 m³/s) each. The system operates at positive pressure to minimize infiltration of room air.

To mix the test aerosol with the air stream, an orifice plate and mixing baffle were located immediately downstream of the aerosol injection point and upstream of the test arrestor. An identical orifice plate and mixing baffle were added after the 180° bend. The latter downstream orifice served two purposes. It straightened out the flow after going around the bend, and it mixed any aerosol that penetrated the air cleaning device. Mixing the penetrating aerosol with the air stream is necessary to obtain a representative downstream aerosol measurement.

AIRFLOW

Airflow was measured with a 4.00 in. (0.102 m) ID American Society of Mechanical Engineers (ASME) flow nozzle. The nominal velocity through the arrestor was computed by dividing the volumetric flow by the nominal face area of the device. Airflow was manually controlled by a 14 in. (0.36 m) diameter butterfly valve.

OPTICAL PARTICLE COUNTER (OPC)

Aerosol concentrations were measured with a Climet Instruments Model 500 OPC. The OPC has 15 channels covering the range from 0.3 to 10 µm diameter. The OPC uses a laser-light illumination source and has a wide collection angle for the scattered light. The OPC's sampling rate was 0.25 cfm (0.00012 m³/s).

The OPC was equipped to provide a contact closure at the end of each sample and also provides a 15-sec delay in particle counting after each sample. The contact closure was used to control the operation of electromechanical valve actuators in the upstream and downstream sample lines. The 15-sec delay allows time for the new sample to be acquired.

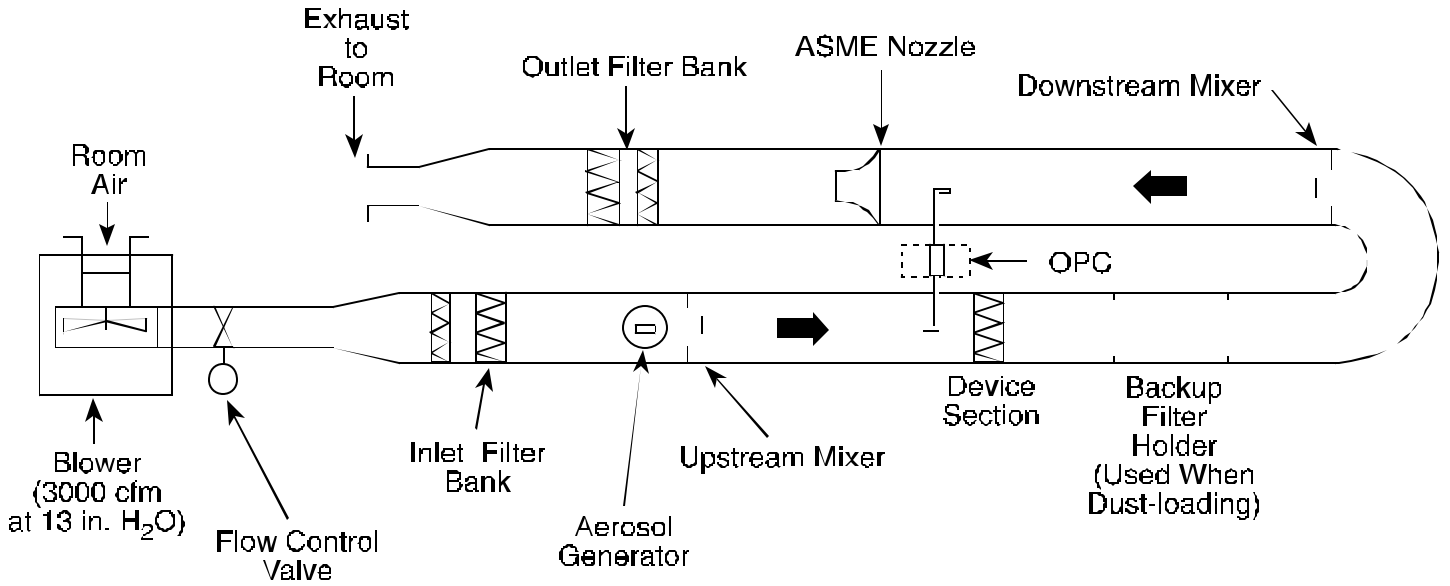

Overview of Test Duct Configuration (Top View)

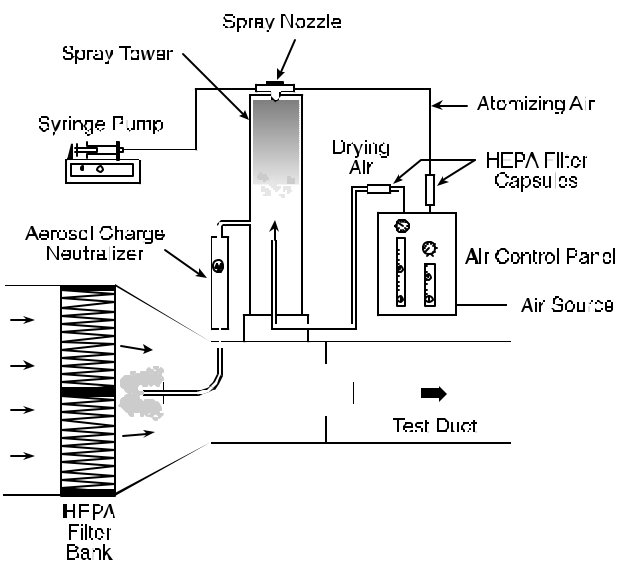

Aerosol Generation System (Side View)

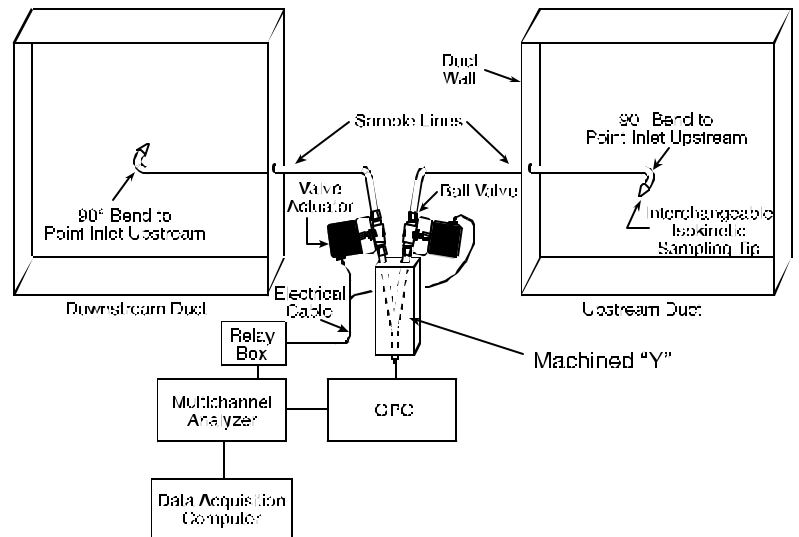

Aerosol Sampling System (End View)

Figure A-1. Schematic illustration of the fractional efficiency test rig.

AEROSOL GENERATION

Two types of challenge aerosols were used: liquid- and solid-phase. The selection of liquid- or solid-phase challenge aerosol particles is important because, for some types of paint arrestors, significantly different filtration efficiencies will be achieved depending upon the phase of the challenge aerosol particles. (This is due to particle "bounce" associated with solid-phase particles.) The liquid-phase challenge aerosol is oleic acid, a non-toxic, low-volatility liquid. The solid-phase aerosol is potassium chloride (KCl) generated from an aqueous solution. KCl was selected as the solid-phase aerosol because of its relatively high water solubility, high deliquescence humidity (85% relative humidity), known crystalline structure (facilitates complete drying), and low toxicity. The KCl solution was prepared by combining 0.66 lb (300 g) of KCl with 0.035 ft³ (1 L) of distilled water. Both oleic acid and KCl are compatible with accurate measurement by the OPC.

The oleic acid or the KCl solution was nebulized using a two-fluid (air and liquid) air atomizing nozzle (Spray Systems 1/4 J siphon spray nozzle) as illustrated in Figure A-1 (aerosol generation system). The nozzle was positioned at the top of a 12 in. (0.30 m) diameter, 51 in. (1.3 m) tall transparent acrylic spray tower. The tower served two purposes. It allowed the salt droplets to dry by providing an approximate 40 sec mean residence time, and it allowed larger-sized particles (of either KCl or oleic acid) to fall out of the aerosol. After generation, the aerosol passed through a TSI Model 3054 aerosol neutralizer (Kr-85 radioactive source) to neutralize any electrostatic charge on the aerosol (electrostatic charging is an unavoidable consequence of most aerosol-generation methods).

The KCl solution or oleic acid was fed to the atomizing nozzle at 1.2 mL/min by means of a pump. Varying the operating air pressure of the generator allows control of the output aerosol concentration.

AEROSOL SAMPLING SYSTEM

The aerosol sampling lines were 0.55 in. (14 mm) ID stainless steel lines and used gradual bends [radius of curvature = 2.25 in. (57 mm)] when needed. These dimensions were chosen to minimize particle losses in the sample lines. A custom-made "Y" fitting connected the upstream and downstream lines to the OPC. The two branches of the "Y" merged gradually to minimize particle loss in the intersection of the "Y" due to centrifugal or impaction forces.

Immediately above the "Y," electrically actuated ball valves were installed in each branch (Parker Model EA Electro-Mechanical Valve Actuator). The opening and closing of the valves were automatically controlled by the OPC's sequential sampling interface board. The valves take approximately 2 sec to complete an opening or closing maneuver.

Isokinetic sampling nozzles of the appropriate entrance diameter were placed on the ends of the sample probes to maintain isokinetic sampling for all the test flow rates.

TEST PROCEDURES

The aerosol penetration of the test device was calculated from the average of 10 upstream and 10 downstream samples taken sequentially (i.e., one upstream, one downstream, one upstream, one downstream, . . . until 10 each were obtained). This sequential sampling scheme was selected to minimize the effect of aerosol generator variability. Each sample was 2 minutes in duration. The sampling also included background upstream and downstream measurements at the beginning and end of each test. The test sequence was as follows:

1. Warm up OPC and install proper sample tips for isokinetic sampling.
2. Install air cleaner test device and bring test duct to desired flow rate.
3. With the aerosol generator off, obtain one measurement each of the upstream and downstream background particle counts.
4. Turn on the aerosol generator and allow it to run for a minimum of 10 minutes to stabilize.
5. After the stabilization period, obtain 10 upstream and 10 downstream particle counts using a repeated upstream-downstream sampling sequence until 10 each are obtained.
6. Turn off the aerosol generator. Wait 10 minutes, then obtain one additional upstream and downstream background measurement.

CONTROL TESTS

In addition to evaluating the test arrestor, 0 and 100% penetration control tests and a reference filter control test were conducted to ensure that reliable measurements are obtained. The 100% penetration test was a relatively stringent test of the adequacy of the overall duct, sampling, measurement, and aerosol generation system. These tests were performed as normal penetration tests except that the paint arrestor was not used. A perfect system would yield a measured penetration of 1 at all particle sizes. Deviations from 1 can occur due to particle losses in the duct, differences in the degree of aerosol uniformity (i.e., mixing) at the upstream and downstream probes, and differences in particle-transport efficiency in the upstream and downstream sampling lines. Results from the 100% penetration tests were used during data analysis to correct penetration measurements obtained during the arrestor tests.

The 0% penetration test was performed by using a HEPA filter rather than a paint arrestor. This test confirmed the adequacy of the instrument response time and sample line lag. The 0% penetration test was performed on a monthly basis.

The reference filter control test consisted of performing a solid-phase efficiency test on the same filter during each ETV test. The reference filter data from each test were compared to the original, baseline reference filter data to determine if there was any substantial change in the test system between the tests.

DATA ANALYSIS

Nomenclature

- P = Penetration corrected for P_{100} value
- D = Downstream particle count
- D_b = Downstream background count
- U = Upstream particle count
- U_b = Upstream background count
- P_{100} = 100% penetration value determined from the control tests
- Overbar: denotes arithmetic mean of quantity

Analysis of each test involves the following quantities:

- ! P_{100} value for each sizing channel from the blank (no-filter) test,
- ! 2 upstream background values,
- ! 2 downstream background values,
- ! 10 upstream values with aerosol generator on, and
- ! 10 downstream values with aerosol generator on.

Using the values associated with each sizing channel, the penetration associated with each particle sizing channel was calculated as:

$$P = \{(\bar{D} - \bar{D}_b) / (\bar{U} - \bar{U}_b)\} / P_{100} .$$

Filtration efficiency was then calculated as:

$$\text{Filtration Efficiency (\%)} = 100 (1 - P).$$

DEFINITION OF PARTICLE DIAMETER

Over the 0.3 to 10 μm diameter size range, the "aerodynamic" particle diameter is often of more significance than the physical diameter (as measured by the OPC) relative to aerosol filtration and aerosol deposition within the human respiratory tract. The aerodynamic diameter (D_{Aero}) is related to the physical diameter (D_{Physical}) by:

$$D_{\text{Aero}} = D_{\text{Physical}} \sqrt{\frac{\rho_{\text{Particle}}}{\rho_o} \frac{CCF_{\text{Physical}}}{CCF_{\text{Aero}}} \frac{1}{X}}$$

where

ρ_{Particle} is the density of the particle in g/cm^3 .

ρ_o is unit density of $1 \text{ g}/\text{cm}^3$.

CCF_{Physical} is the Cunningham Correction Factor at D_{Physical} .

CCF_{Aero} is the Cunningham Correction Factor at D_{Aero} .

X is the dynamic shape factor.

Note: due to the interdependence of D_{aero} and CCF_{Aero} , the equation is solved iteratively.

For oleic acid droplets having a density of $0.89 \text{ g}/\text{cm}^3$ and being spherical ($X = 1$), the aerodynamic diameter will be about 6% smaller than the measured diameter.

KCl has a density of $1.98 \text{ g}/\text{cm}^3$. The KCl particles form from the evaporation of aqueous solution droplets. Because KCl has an inherent cubic crystalline structure, it is expected that the KCl particles will be cubic or relatively compact cubic clusters; however, their actual shape, or range of shapes, is unknown. Because the shape factor is unknown, the shape factor for KCl is assigned a value of 1 and the diameter is termed the "nominal" aerodynamic diameter.

The aerodynamic diameters associated with the 15 OPC sizing channels are tabulated in Table A-1 for oleic acid and KCl. Also listed is the physical diameter size range for each channel based on the manufacturer's calibration curve using monodisperse polystyrene latex (PSL) spheres.

**Table A-1. Physical and Aerodynamic Sizing Channels
for the Calibration and Test Aerosols**

	Particle Diameter Size Range (μm)*		
	PSL	OLEIC ACID	KCl
OPC Channel Number	Physical Diameter	Aerodynamic Diameter	Nominal Aerodynamic Diameter
1	0.3 - 0.4	0.28 - 0.37	0.45 - 0.59
2	0.4 - 0.5	0.37 - 0.47	0.59 - 0.73
3	0.5 - 0.55	0.47 - 0.52	0.73 - 0.80
4	0.55 - 0.7	0.52 - 0.66	0.80 - 1.02
5	0.7 - 1.0	0.66 - 0.94	1.02 - 1.44
6	1.0 - 1.3	0.94 - 1.22	1.44 - 1.86
7	1.3 - 1.6	1.22 - 1.51	1.86 - 2.28
8	1.6 - 2	1.51 - 1.88	2.28 - 2.85
9	2 - 2.2	1.88 - 2.07	2.85 - 3.13
10	2.2 - 3	2.07 - 2.83	3.13 - 4.25
11	3 - 4	2.83 - 3.77	4.25 - 5.66
12	4 - 5	3.77 - 4.71	5.66 - 7.07
13	5 - 5.5	4.71 - 5.18	7.07 - 7.77
14	5.5 - 7	5.18 - 6.60	7.77 - 9.88
15	7 - 10	6.60 - 9.43	9.88 - 14.1

*The particle diameter size ranges are defined as greater than the indicated lower limit and less than or equal to the indicated upper limit.

APPENDIX B
Certificates of Calibration

Certificate of Traceability

8500D-II THERMOANEMOMETER

Model No. 8500D-II Serial No. 3810 Part No. 634493200

Certificate Number: 1946 Date: 26-Oct-88 P.O. 00329 Order/RMA: 404638
 Customer Number:

Calibration Standards Information
 The following standards and equipment were used as references for this calibration.

Tested By	Date Tested	Insl. No.	Cal. Due	NIST Test Numbers
LOZADA	10/23/88	747	4/9/00	2593-4; 257802; 259800; 256692; 260222; 811255682;
		746	4/9/00	811255622; 811260176;
		922	6/8/00	536255547-93
		831	11/08/88	811257078 ; 247770 ; 263606 ; 811255674 ; 253639 ; USN22783C ; Chem Const. ; 254227 ; 811254736 ; 811251562 ; 251971 ; 811251741 ; 811253662 ; 811256216 ; 811822 ;
		657	6/8/00	836259947-98
		794	3/13/90	
		688	2/21/00	811266766 ; 251971 ; 811255004-80 ; 811257773 ; 256216 ;
		399	11/12/88	P-8531A ; P-8531B ; 38126 ; 254160 ; 2563002 ;
		325	2-4-99	P-8531A ; P-8531B ; 38126 ; 254160 ; 2590009 ;
		313	11/12/88	P-8531A ; P-8531B ; 38126 ; 254160 ; 2563002 ;
		301	12/11/88	835257126-96 ;

Alnor Instrument Company hereby certifies that the above designated equipment was found to meet or exceed manufacturing specifications. Their calibration is traceable to the National Institute of Standards and Technology (NIST) or national physical constants. The policies and procedures used comply with ML-STD-4562A. This certificate shall not be reproduced except in full, without the written consent of Alnor.

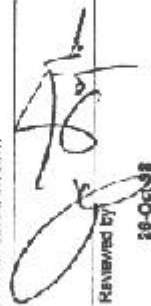
Reviewed by: 

26-Oct-88

Date



Alnor Instrument Company
 7555 W. Linder Avenue, Sicak, IL 60077
 Tel. 847-677-3500 Fax. 847-677-3539



FILE NO. 040FB:001-19
PAGE 1 OF 1

LETTER OF CERTIFICATION
LAMINAR FLOW ELEMENT

CUSTOMER NAME: RESEARCH TRIANGLE INST
 CUSTOMER ORDER NUMBER: 00161
 MERIAM ORDER NUMBER: 772900

Meriam Instrument certifies that the completed LFE unit has been calibrated and correlated at several points of flow rate using a Meriam Standard, which is controlled per the calibration system requirements of ANSI Z540-1 and traceable to the National Institute of Standards and Technology. The collective uncertainty of the measurement standards has a 1:1 ratio to the acceptable tolerance for the flow rate being calibrated.

The total rss uncertainty of the completed laminar flow unit is +/- .72 % of reading.

CUSTOMER ID NO.: 013716

MODEL NO.: 50MH10-8 SERIAL NO.: 758860-K1

FLOW CURVE/TABLE NO.: 30624

DATE OF CALIBRATION 11-11-1998 BY GEORGE ROBOTKAY

AS RECEIVED CONDITION: In Tolerance Out of Tolerance NA

AS LEFT CONDITION : In Tolerance Out of Tolerance NA

CALIBRATION INTERVAL: TO BE DETERMINED BY CUSTOMER BASED ON USAGE OF LFE.

FLOW STANDARD SERIAL NO.	DATE OF LAST CAL	DATE OF NEXT CAL
WMMC2-6	JAN 1998	JAN 1999

The LFE unit listed hereon has been successfully calibrated in accordance with Meriam Instrument Procedure A-35822.

Michael V. ...
 QUALITY ASSURANCE INSPECTOR
 MERIAM INSTRUMENT

Jack Weigand
 QUALITY ASSURANCE MANAGER
 MERIAM INSTRUMENT

CLIMET INSTRUMENTS COMPANY

1320 WEST COLTON AVE., REDLANDS, CA 92374 • PHONE: (909) 793-2788 • FAX: (909) 793-1738

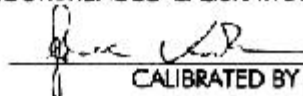
CERTIFICATE OF CALIBRATION**INSTRUMENT CALIBRATED**MODEL: CT-500 aerosol particle counter, S/N 97-1821CONTROL NUMBER: 61624001DATE CALIBRATED: 09/03/99 NEXT CALIBRATION: 09/03/00RECOMMENDED CALIBRATION INTERVAL: 12 months

CALIBRATED BY

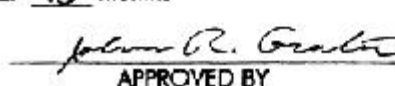

APPROVED BY
TRACEABILITY STATEMENT

This instrument has been calibrated in accordance with ISO 10012-1/ANSI Z540-1 (which replaces MIL-STD-45662A) and relevant portions of Federal Standards 209, ASTM F-50, F322, and F328.

Temperature and Relative Humidity are not controlled during calibration because of the wide operating range of the instrument. The operating limits of this instrument are:

TEMPERATURE: 30°F TO 122°F
HUMIDITY: 0-100%, non-condensing

All test equipment used in the calibration of Climet Instruments' products is calibrated at six-month intervals by an outside calibration service. Calibration certificates for each piece of test equipment are on file at Climet; copies will be supplied if requested.

Calibration traceability to a National Measurement Standard (NMS) is established by using mono-disperse latex spheres as a calibration standard. These spheres are sized by methods traceable, by lot number, to the National Institute of Science and Technology.

APPENDIX C
Fractional Efficiency Data Sheets

Key to notation used in the following tables:

Diam.:	Particle Diameter (µm)
U. Bckgrnd:	The upstream background particle counts measured with the aerosol generator off.
Upstream:	The upstream particle counts measured with the aerosol generator on.
D. Bckgrnd:	The downstream background particle counts measured with the aerosol generator off.
Downstream:	The downstream particle counts measured with the aerosol generator on.
Meas. Penetration:	The penetration computed as:

$$\text{Meas. Penetration} = \frac{(\text{Downstream} \& \text{D. Bckgrnd})}{(\text{Upstream} \& \text{U. Bckgrnd})}$$

P100 Correction Values:	Penetration values measured with no filter in the test section. These values are used to correct subsequent penetration measurements for particle losses within the test duct and sampling system.
-------------------------	--

Corrected Penetration:	The measured penetration corrected by the P100 values:
------------------------	--

$$\text{Corrected Penetration} = \frac{\text{Meas. Penetration}}{\text{P100 Correction Values}}$$

Corrected Efficiency (%):	100 x (1 - Corrected Penetration)
---------------------------	-------------------------------------

DQO	Data Quality Objective
-----	------------------------

Test No. 10059901
 No Filter
 Solid-Phase

Particle Counts per Indicated OPC Channel (1-Minute Samples @ 7.1 L/min)

OPC Channel Number	1	2	3	4	5	6	7	8	9	10	11	12	13	14	15
Min. Diam. (um)	0.45	0.59	0.73	0.80	1.02	1.44	1.86	2.28	2.85	3.13	4.25	5.66	7.07	7.77	9.88
Max. Diam. (um)	0.59	0.73	0.80	1.02	1.44	1.86	2.28	2.85	3.13	4.25	5.66	7.07	7.77	9.88	14.10
Geo. Mean Diam (um)	0.52	0.66	0.77	0.90	1.21	1.64	2.06	2.55	2.98	3.65	4.91	6.33	7.41	8.76	11.81

ENTER DATA BELOW

U. Bckgrnd	1 Dif	10-05-1999	10:01:25	0.2 CF	0	0	0	0	0	0	0	0	0	0	0	0			
U. Bckgrnd	1 Dif	10-05-1999	10:03:31	0.2 CF	3	0	0	0	0	0	0	0	0	0	0	0			
Upstream	1 Dif	10-05-1999	10:21:20	0.2 CF	10729	8602	2296	6336	12193	4895	3133	2203	1168	3616	2275	1189	485	931	625
Upstream	1 Dif	10-05-1999	10:23:26	0.2 CF	10876	8924	2316	6669	12691	5002	3253	2392	1231	3693	2313	1270	507	937	680
Upstream	1 Dif	10-05-1999	10:25:32	0.2 CF	10880	8884	2382	6525	12664	5001	3054	2340	1273	3824	2386	1216	495	958	646
Upstream	1 Dif	10-05-1999	10:27:38	0.2 CF	11102	8881	2405	6628	12889	5130	3040	2404	1294	3796	2409	1245	504	918	708
Upstream	1 Dif	10-05-1999	10:29:44	0.2 CF	10839	9002	2457	6643	12590	5216	3134	2267	1233	3764	2445	1226	534	876	612
Upstream	1 Dif	10-05-1999	10:31:50	0.2 CF	10922	8855	2440	6685	12572	5156	3064	2305	1198	3719	2418	1252	507	871	668
Upstream	1 Dif	10-05-1999	10:33:56	0.2 CF	10966	8732	2428	6698	12468	5075	3180	2268	1211	3742	2388	1206	504	864	665
Upstream	1 Dif	10-05-1999	10:36:02	0.2 CF	11004	8652	2351	6595	12424	5083	3067	2242	1222	3634	2391	1210	513	952	657
Upstream	1 Dif	10-05-1999	10:38:08	0.2 CF	10677	8613	2354	6560	12491	4975	2947	2270	1255	3682	2438	1197	481	874	626
Upstream	1 Dif	10-05-1999	10:40:14	0.2 CF	10747	8855	2252	6521	12348	5014	3123	2251	1230	3687	2331	1212	520	911	676
U. Bckgrnd	1 Dif	10-05-1999	10:50:44	0.2 CF	1	0	0	0	0	0	0	0	0	0	0	0	0	0	0
U. Bckgrnd	1 Dif	10-05-1999	10:52:50	0.2 CF	1	0	0	0	0	0	0	0	0	0	0	0	0	0	0

ENTER DATA BELOW

D. Bckgrnd	2 Dif	10-05-1999	10:02:28	0.2 CF	0	0	0	0	0	0	0	0	0	0	0	0	0	0	
Downstream	2 Dif	10-05-1999	10:22:23	0.2 CF	10666	8615	2370	6417	12522	4907	3088	2239	1199	3591	2343	1196	435	833	662
Downstream	2 Dif	10-05-1999	10:24:29	0.2 CF	10522	8809	2359	6392	12578	4998	3069	2284	1222	3785	2320	1198	529	864	666
Downstream	2 Dif	10-05-1999	10:26:35	0.2 CF	10717	8655	2359	6496	12807	5074	3161	2263	1254	3836	2410	1166	506	877	600
Downstream	2 Dif	10-05-1999	10:28:41	0.2 CF	11255	8899	2439	6808	12818	5130	3344	2338	1182	3751	2447	1235	499	870	634
Downstream	2 Dif	10-05-1999	10:30:47	0.2 CF	10946	9170	2427	6674	13014	5238	3241	2461	1235	3969	2489	1251	487	859	613
Downstream	2 Dif	10-05-1999	10:32:53	0.2 CF	11023	8806	2405	6771	12766	5237	3223	2271	1257	3685	2391	1246	510	906	591
Downstream	2 Dif	10-05-1999	10:34:59	0.2 CF	10921	9100	2385	6607	12741	5044	3191	2337	1283	3851	2402	1204	514	940	680
Downstream	2 Dif	10-05-1999	10:37:05	0.2 CF	10786	8640	2398	6473	12678	4878	3027	2318	1274	3629	2354	1207	475	925	639
Downstream	2 Dif	10-05-1999	10:39:11	0.2 CF	10964	8852	2330	6708	12569	5154	3113	2259	1223	3816	2365	1160	473	914	680
Downstream	2 Dif	10-05-1999	10:41:17	0.2 CF	10869	8725	2294	6663	12567	5071	3126	2222	1229	3796	2406	1189	510	882	623
D. Bckgrnd	2 Dif	10-05-1999	10:51:47	0.2 CF	2	1	0	0	0	0	0	0	0	0	0	0	0	0	0

Meas. Penetration	1.00	1.00	1.00	1.00	1.01	1.00	1.02	1.00	1.00	1.01	1.01	0.99	0.98	0.98	0.97
P100 correction values	1.00	1.00	1.00	1.00	1.00	1.00	1.00	1.00	1.00	1.00	1.00	1.00	1.00	1.00	1.00
Corrected Penetration	1.00	1.00	1.00	1.00	1.01	1.00	1.02	1.00	1.00	1.01	1.01	0.99	0.98	0.98	0.97
Corrected Efficiency (%)	0	0	0	0	-1	0	-2	0	0	-1	-1	1	2	2	3

Data Acceptance Criteria:

Total Challenge Counts for Each Channel:	108742	88000	23681	65860	125330	50547	30995	22942	12315	37157	23794	12223	5050	9092	6563
Data Quality Objective:	> 500	> 500	> 500	> 500	> 500	> 500	> 500	> 500	> 500	> 500	> 500	> 500	> 500	> 500	> 500
Does this meet DQO:	Yes	Yes	Yes	Yes	Yes	Yes	Yes	Yes	Yes	Yes	Yes	Yes	Yes	Yes	Yes

Standard Deviation of Penetration for Each Channel :	0.02	0.03	0.03	0.03	0.02	0.03	0.04	0.04	0.04	0.04	0.03	0.03	0.06	0.05	0.07
Data Quality Objective:	<0.10	<0.10	<0.10	<0.10	<0.10	<0.10	<0.10	<0.10	<0.10	<0.30	<0.30	<0.30	<0.30	<0.30	<0.30
Does this meet DQO:	Yes	Yes	Yes	Yes	Yes	Yes	Yes	Yes	Yes	Yes	Yes	Yes	Yes	Yes	Yes

Maximum observed particle concentration (#/cc):	11.6
Data Quality Objective: max. allowable conc. (#/cc):	< 14
Does this meet the DQO:	Yes, (applies to all channels)

Test No. 10059903

Reference
Solid-Phase

Particle Counts per Indicated OPC Channel (1-Minute Samples @ 7.1 L/min)

OPC Channel Number	1	2	3	4	5	6	7	8	9	10	11	12	13	14	15
Min. Diam. (um)	0.45	0.59	0.73	0.80	1.02	1.44	1.86	2.28	2.85	3.13	4.25	5.66	7.07	7.77	9.88
Max. Diam. (um)	0.59	0.73	0.80	1.02	1.44	1.86	2.28	2.85	3.13	4.25	5.66	7.07	7.77	9.88	14.10
Geo. Mean Diam (um)	0.52	0.66	0.77	0.90	1.21	1.64	2.06	2.55	2.98	3.65	4.91	6.33	7.41	8.76	11.81

ENTER DATA BELOW

U. Bckgrnd	1 Dif	10-05-1999	13:28:38	0.2 CF	2	0	0	0	0	0	0	0	0	0	0	0			
U. Bckgrnd	1 Dif	10-05-1999	13:30:44	0.2 CF	0	0	0	0	0	0	0	0	0	0	0	0			
Upstream	1 Dif	10-05-1999	13:34:56	0.2 CF	10027	8045	2078	5973	11622	4572	2855	2220	1128	3554	2166	1156	497	857	660
Upstream	1 Dif	10-05-1999	13:37:02	0.2 CF	10273	8153	2145	6112	11557	4751	2950	2158	1178	3624	2338	1161	513	839	644
Upstream	1 Dif	10-05-1999	13:39:08	0.2 CF	10250	8216	2330	6288	11763	4780	2909	2229	1136	3554	2197	1216	464	864	649
Upstream	1 Dif	10-05-1999	13:41:14	0.2 CF	10121	8180	2162	6162	11851	4767	3015	2212	1195	3525	2202	1184	466	887	713
Upstream	1 Dif	10-05-1999	13:43:20	0.2 CF	10208	8265	2306	6135	11936	4694	2924	2194	1147	3490	2243	1152	485	853	644
Upstream	1 Dif	10-05-1999	13:45:26	0.2 CF	10352	8052	2155	6040	11849	4792	2973	2123	1180	3589	2304	1200	460	849	580
Upstream	1 Dif	10-05-1999	13:47:32	0.2 CF	9973	8021	2113	6133	11546	4756	2984	2181	1178	3371	2277	1122	452	912	622
Upstream	1 Dif	10-05-1999	13:49:38	0.2 CF	10050	8171	2196	6130	11649	4666	2997	2103	1149	3447	2239	1166	472	824	611
Upstream	1 Dif	10-05-1999	13:51:44	0.2 CF	10086	7980	2139	6028	11661	4670	2977	2191	1197	3454	2285	1151	458	910	625
Upstream	1 Dif	10-05-1999	13:53:50	0.2 CF	10102	8016	2211	6109	11520	4589	2861	2134	1110	3420	2204	1154	505	884	655
U. Bckgrnd	1 Dif	10-05-1999	14:02:14	0.2 CF	6	0	0	0	0	0	0	0	0	0	0	0	0	0	0
U. Bckgrnd	1 Dif	10-05-1999	14:04:20	0.2 CF	1	0	0	0	0	0	0	0	0	0	0	0	0	0	0

ENTER DATA BELOW

D. Bckgrnd	2 Dif	10-05-1999	13:29:41	0.2 CF	0	0	0	0	0	0	0	0	0	0	0	0	0	0	0
Downstream	2 Dif	10-05-1999	13:35:59	0.2 CF	10098	8088	2175	6013	11575	4566	2697	2011	1062	3122	1653	745	203	365	141
Downstream	2 Dif	10-05-1999	13:38:05	0.2 CF	10046	8229	2191	6151	11314	4513	2684	1931	1059	3127	1682	755	245	428	138
Downstream	2 Dif	10-05-1999	13:40:11	0.2 CF	10342	8313	2137	5973	11564	4544	2796	1939	1044	3015	1836	765	251	379	137
Downstream	2 Dif	10-05-1999	13:42:17	0.2 CF	10291	8258	2042	5991	11597	4650	2879	1995	1177	3160	1759	747	250	348	116
Downstream	2 Dif	10-05-1999	13:44:23	0.2 CF	10093	7961	2122	6011	11315	4499	2833	2023	1084	3052	1722	688	236	320	119
Downstream	2 Dif	10-05-1999	13:46:29	0.2 CF	10363	8111	2193	5916	11596	4528	2825	2069	1062	2995	1686	726	263	333	142
Downstream	2 Dif	10-05-1999	13:48:35	0.2 CF	10079	7953	2159	5832	11220	4629	2742	1918	1049	3022	1791	697	252	371	133
Downstream	2 Dif	10-05-1999	13:50:41	0.2 CF	10194	7974	2134	5965	11277	4576	2719	1908	1005	2996	1661	714	252	342	134
Downstream	2 Dif	10-05-1999	13:52:47	0.2 CF	10012	8020	2243	5986	11261	4418	2759	1987	1007	3069	1783	730	233	338	157
Downstream	2 Dif	10-05-1999	13:54:53	0.2 CF	10088	8079	2094	5859	11377	4516	2619	1879	976	2997	1672	754	240	340	138
D. Bckgrnd	2 Dif	10-05-1999	14:03:17	0.2 CF	2	0	0	0	0	0	0	0	0	0	0	0	0	0	0

Meas. Penetration	1.00	1.00	0.98	0.98	0.98	0.97	0.94	0.90	0.91	0.87	0.77	0.63	0.51	0.41	0.21
P100 correction values	1.00	1.00	1.00	1.00	1.01	1.00	1.02	1.00	1.00	1.01	1.01	0.99	0.98	0.98	0.97
Corrected Penetration	1.00	1.00	0.98	0.97	0.96	0.96	0.92	0.90	0.90	0.86	0.76	0.64	0.52	0.42	0.22
Corrected Efficiency (%)	0	0	2	3	4	4	8	10	10	14	24	36	48	58	78

Data Acceptance Criteria:

Total Challenge Counts for Each Channel:	101442	81099	21835	61110	116954	47037	29445	21745	11598	35028	22455	11662	4772	8679	6403
Data Quality Objective:	> 500	> 500	> 500	> 500	> 500	> 500	> 500	> 500	> 500	> 500	> 500	> 500	> 500	> 500	> 500
Does this meet DQO:	Yes	Yes	Yes	Yes	Yes	Yes	Yes	Yes	Yes	Yes	Yes	Yes	Yes	Yes	Yes

Standard Deviation of Penetration for Each Channel :	0.02	0.02	0.04	0.02	0.02	0.02	0.03	0.03	0.05	0.03	0.03	0.03	0.04	0.04	0.02
Data Quality Objective:	<0.10	<0.10	<0.10	<0.10	<0.10	<0.10	<0.10	<0.10	<0.10	<0.30	<0.30	<0.30	<0.30	<0.30	<0.30
Does this meet DQO:	Yes	Yes	Yes	Yes	Yes	Yes	Yes	Yes	Yes	Yes	Yes	Yes	Yes	Yes	Yes

Maximum observed particle concentration (#/cc):	10.7
Data Quality Objective: max. allowable conc. (#/cc):	< 14
Does this meet the DQO:	Yes, (applies to all channels)

Test No. 10059904
 No Filter
 Solid-Phase

Particle Counts per Indicated OPC Channel (1-Minute Samples @ 7.1 L/min)

OPC Channel Number	1	2	3	4	5	6	7	8	9	10	11	12	13	14	15
Min. Diam. (um)	0.45	0.59	0.73	0.80	1.02	1.44	1.86	2.28	2.85	3.13	4.25	5.66	7.07	7.77	9.88
Max. Diam. (um)	0.59	0.73	0.80	1.02	1.44	1.86	2.28	2.85	3.13	4.25	5.66	7.07	7.77	9.88	14.10
Geo. Mean Diam (um)	0.52	0.66	0.77	0.90	1.21	1.64	2.06	2.55	2.98	3.65	4.91	6.33	7.41	8.76	11.81

ENTER DATA BELOW

U. Bckgrnd	1 Dif	10-05-1999	14:23:14	0.2 CF	4	0	0	0	0	0	0	0	0	0	0	0			
U. Bckgrnd	1 Dif	10-05-1999	14:25:20	0.2 CF	0	0	0	0	1	0	0	0	0	0	0	0			
Upstream	1 Dif	10-05-1999	14:31:38	0.2 CF	9928	8095	2137	6027	11500	4666	2831	2060	1170	3391	2196	1103	474	818	630
Upstream	1 Dif	10-05-1999	14:33:44	0.2 CF	10128	8148	2194	6021	11599	4632	2882	2172	1189	3509	2298	1144	484	909	663
Upstream	1 Dif	10-05-1999	14:35:50	0.2 CF	10166	7982	2203	6242	11653	4736	2795	2168	1128	3585	2240	1136	450	837	653
Upstream	1 Dif	10-05-1999	14:37:56	0.2 CF	10311	8380	2134	6149	11681	4703	2911	2181	1123	3477	2198	1138	483	813	659
Upstream	1 Dif	10-05-1999	14:40:02	0.2 CF	10532	8299	2197	6246	12196	4802	3002	2207	1252	3613	2297	1165	518	876	652
Upstream	1 Dif	10-05-1999	14:42:08	0.2 CF	10436	8620	2343	6300	12089	4908	2926	2149	1179	3541	2291	1165	449	844	632
Upstream	1 Dif	10-05-1999	14:44:14	0.2 CF	10404	8446	2211	6304	12232	4817	2934	2161	1188	3606	2331	1212	489	909	704
Upstream	1 Dif	10-05-1999	14:46:20	0.2 CF	10463	8431	2231	6385	11964	4779	2917	2153	1110	3481	2249	1155	507	828	593
Upstream	1 Dif	10-05-1999	14:48:26	0.2 CF	10178	8191	2140	6018	11798	4712	2921	2135	1093	3370	2249	1109	450	858	623
Upstream	1 Dif	10-05-1999	14:50:32	0.2 CF	10032	8256	2156	6178	11784	4660	2868	2075	1164	3369	2334	1135	460	864	626
U. Bckgrnd	1 Dif	10-05-1999	14:58:56	0.2 CF	1	1	0	0	0	0	0	0	0	0	0	0	0	0	0
U. Bckgrnd	1 Dif	10-05-1999	15:01:02	0.2 CF	0	0	0	0	0	0	0	0	0	0	0	0	0	0	0

ENTER DATA BELOW

D. Bckgrnd	2 Dif	10-05-1999	14:24:17	0.2 CF	2	3	0	0	0	0	0	0	0	0	0	0	0	0	0
Downstream	2 Dif	10-05-1999	14:32:41	0.2 CF	10221	8049	2159	6213	11573	4692	2809	2059	1161	3548	2237	1125	468	844	631
Downstream	2 Dif	10-05-1999	14:34:47	0.2 CF	10120	8288	2135	6210	11988	4661	2933	2195	1173	3603	2251	1242	476	869	591
Downstream	2 Dif	10-05-1999	14:36:53	0.2 CF	10039	8330	2104	6137	11822	4676	2830	2154	1144	3489	2278	1146	459	906	626
Downstream	2 Dif	10-05-1999	14:38:59	0.2 CF	10069	8220	2150	6201	11804	4744	2912	2138	1157	3474	2232	1119	481	864	711
Downstream	2 Dif	10-05-1999	14:41:05	0.2 CF	10590	8419	2204	6223	12071	4830	2979	2181	1127	3497	2257	1146	487	864	627
Downstream	2 Dif	10-05-1999	14:43:11	0.2 CF	10463	8491	2169	6434	12173	4830	2966	2182	1156	3525	2319	1163	459	847	613
Downstream	2 Dif	10-05-1999	14:45:17	0.2 CF	10492	8456	2233	6513	12157	4866	2954	2259	1161	3676	2343	1174	481	797	606
Downstream	2 Dif	10-05-1999	14:47:23	0.2 CF	10398	8389	2226	6326	11997	4743	3021	2166	1186	3601	2278	1109	476	818	595
Downstream	2 Dif	10-05-1999	14:49:29	0.2 CF	10234	8090	2161	6223	11914	4840	2839	2179	1156	3544	2266	1161	443	889	624
Downstream	2 Dif	10-05-1999	14:51:35	0.2 CF	10273	8188	2254	6299	11780	4578	2907	2088	1143	3523	2180	1124	452	767	601
D. Bckgrnd	2 Dif	10-05-1999	14:59:59	0.2 CF	1	0	0	0	1	0	0	0	0	0	0	0	0	0	0

Meas. Penetration	1.00	1.00	0.99	1.01	1.01	1.00	1.01	1.01	1.00	1.02	1.00	1.00	0.98	0.99	0.97
P100 correction values	1.00	1.00	1.00	1.00	1.00	1.00	1.00	1.00	1.00	1.00	1.00	1.00	1.00	1.00	1.00
Corrected Penetration	1.00	1.00	0.99	1.01	1.01	1.00	1.01	1.01	1.00	1.02	1.00	1.00	0.98	0.99	0.97
Corrected Efficiency (%)	0	0	1	-1	-1	0	-1	-1	0	-2	0	0	2	1	3

Data Acceptance Criteria:

Total Challenge Counts for Each Channel:	102578	82848	21946	61870	118496	47415	28987	21461	11596	34942	22683	11462	4764	8556	6435
Data Quality Objective:	> 500	> 500	> 500	> 500	> 500	> 500	> 500	> 500	> 500	> 500	> 500	> 500	> 500	> 500	> 500
Does this meet DQO:	Yes	Yes	Yes	Yes	Yes	Yes	Yes	Yes	Yes	Yes	Yes	Yes	Yes	Yes	Yes

Standard Deviation of Penetration for Each Channel :	0.03	0.03	0.04	0.03	0.03	0.03	0.03	0.03	0.04	0.03	0.03	0.04	0.06	0.06	0.07
Data Quality Objective:	<0.10	<0.10	<0.10	<0.10	<0.10	<0.10	<0.10	<0.10	<0.10	<0.30	<0.30	<0.30	<0.30	<0.30	<0.30
Does this meet DQO:	Yes	Yes	Yes	Yes	Yes	Yes	Yes	Yes	Yes	Yes	Yes	Yes	Yes	Yes	Yes

Maximum observed particle concentration (#/cc):	10.9
Data Quality Objective: max. allowable conc. (#/cc):	< 14
Does this meet the DQO:	Yes, (applies to all channels)

Test No. 10059905

Arrestor
Solid-Phase

Particle Counts per Indicated OPC Channel (1-Minute Samples @ 7.1 L/min)

OPC Channel Number	1	2	3	4	5	6	7	8	9	10	11	12	13	14	15
Min. Diam. (um)	0.45	0.59	0.73	0.80	1.02	1.44	1.86	2.28	2.85	3.13	4.25	5.66	7.07	7.77	9.88
Max. Diam. (um)	0.59	0.73	0.80	1.02	1.44	1.86	2.28	2.85	3.13	4.25	5.66	7.07	7.77	9.88	14.10
Geo. Mean Diam (um)	0.52	0.66	0.77	0.90	1.21	1.64	2.06	2.55	2.98	3.65	4.91	6.33	7.41	8.76	11.81

ENTER DATA BELOW

U. Bckgrnd	1 Dif	10-05-1999	15:19:56	0.2 CF	0	2	0	0	0	0	0	0	0	0	0	0			
U. Bckgrnd	1 Dif	10-05-1999	15:22:02	0.2 CF	0	0	0	0	0	0	0	0	0	0	0	0			
Upstream	1 Dif	10-05-1999	15:26:14	0.2 CF	10249	7983	2094	6003	11511	4550	2786	2041	1103	3346	2242	1165	436	853	590
Upstream	1 Dif	10-05-1999	15:28:20	0.2 CF	9866	8149	2196	6218	11585	4440	2803	2085	1125	3414	2184	1131	443	834	658
Upstream	1 Dif	10-05-1999	15:30:26	0.2 CF	10287	8224	2185	6307	12003	4753	2886	2148	1192	3572	2220	1145	450	816	613
Upstream	1 Dif	10-05-1999	15:32:32	0.2 CF	10303	8265	2199	6236	12018	4662	2898	2137	1137	3567	2212	1088	492	809	662
Upstream	1 Dif	10-05-1999	15:34:38	0.2 CF	10433	8545	2269	6237	12152	4670	2919	2103	1177	3553	2280	1204	473	881	662
Upstream	1 Dif	10-05-1999	15:36:44	0.2 CF	10493	8462	2169	6199	12237	4788	3019	2166	1108	3562	2349	1156	452	886	616
Upstream	1 Dif	10-05-1999	15:38:50	0.2 CF	10227	8493	2181	6281	11984	4632	2928	2171	1158	3694	2227	1034	451	845	586
Upstream	1 Dif	10-05-1999	15:40:56	0.2 CF	10188	8353	2174	6295	12050	4742	2934	2020	1203	3577	2252	1113	477	864	620
Upstream	1 Dif	10-05-1999	15:43:02	0.2 CF	10391	8192	2246	6269	11670	4600	2899	2211	1117	3461	2160	1126	439	897	635
Upstream	1 Dif	10-05-1999	15:45:08	0.2 CF	10148	8300	2242	6209	11517	4613	2821	2097	1091	3427	2206	1130	481	890	667
U. Bckgrnd	1 Dif	10-05-1999	15:53:32	0.2 CF	1	0	0	0	0	0	0	0	0	0	0	0	0	0	0
U. Bckgrnd	1 Dif	10-05-1999	15:55:38	0.2 CF	0	0	0	0	0	0	0	0	0	0	0	0	0	0	0

ENTER DATA BELOW

D. Bckgrnd	2 Dif	10-05-1999	15:20:59	0.2 CF	6	1	1	0	1	0	0	0	1	0	0	0	0	0	0
Downstream	2 Dif	10-05-1999	15:27:17	0.2 CF	1706	888	185	359	372	91	28	9	5	12	7	1	2	2	1
Downstream	2 Dif	10-05-1999	15:29:23	0.2 CF	1648	819	176	329	377	67	24	14	4	10	4	1	0	1	2
Downstream	2 Dif	10-05-1999	15:31:29	0.2 CF	1659	836	175	385	338	59	24	7	0	8	6	1	0	3	0
Downstream	2 Dif	10-05-1999	15:33:35	0.2 CF	1670	863	198	356	375	53	25	9	3	15	3	4	1	0	1
Downstream	2 Dif	10-05-1999	15:35:41	0.2 CF	1728	885	192	368	375	68	16	11	4	12	3	2	0	0	1
Downstream	2 Dif	10-05-1999	15:37:47	0.2 CF	1684	858	183	356	391	62	22	7	3	7	4	2	0	1	1
Downstream	2 Dif	10-05-1999	15:39:53	0.2 CF	1654	860	198	352	375	74	25	9	3	6	3	1	0	1	1
Downstream	2 Dif	10-05-1999	15:41:59	0.2 CF	1687	866	174	350	369	70	23	7	5	10	2	0	0	3	0
Downstream	2 Dif	10-05-1999	15:44:05	0.2 CF	1680	853	166	384	394	57	25	7	4	9	4	2	1	2	1
Downstream	2 Dif	10-05-1999	15:46:11	0.2 CF	1729	866	177	353	362	52	26	14	5	10	5	3	0	1	1
D. Bckgrnd	2 Dif	10-05-1999	15:54:35	0.2 CF	7	6	1	1	1	0	0	1	0	3	0	0	0	0	0

Meas. Penetration	0.16	0.10	0.08	0.06	0.03	0.01	0.01	0.00	0.00	0.00	0.00	0.00	0.00	0.00	0.00	0.00	0.00	0.00
P100 correction values	1.00	1.00	0.99	1.01	1.01	1.00	1.01	1.01	1.00	1.02	1.00	1.00	0.98	0.99	0.97			
Corrected Penetration	0.16	0.10	0.08	0.06	0.03	0.01	0.01	0.00	0.00	0.00	0.00	0.00	0.00	0.00	0.00			
Corrected Efficiency (%)	84	90	92	94	97	99	99	100	100	100	100	100	100	100	100			

Data Acceptance Criteria:

Total Challenge Counts for Each Channel:	102585	82966	21955	62254	118727	46450	28893	21179	11411	35173	22332	11292	4594	8575	6309
Data Quality Objective:	> 500	> 500	> 500	> 500	> 500	> 500	> 500	> 500	> 500	> 500	> 500	> 500	> 500	> 500	> 500
Does this meet DQO:	Yes	Yes	Yes	Yes	Yes	Yes	Yes	Yes	Yes	Yes	Yes	Yes	Yes	Yes	Yes

Standard Deviation of Penetration for Each Channel :	0.00	0.00	0.01	0.00	0.00	0.00	0.00	0.00	0.00	0.00	0.00	0.00	0.00	0.00	0.00
Data Quality Objective:	<0.10	<0.10	<0.10	<0.10	<0.10	<0.10	<0.10	<0.10	<0.10	<0.30	<0.30	<0.30	<0.30	<0.30	<0.30
Does this meet DQO:	Yes	Yes	Yes	Yes	Yes	Yes	Yes	Yes	Yes	Yes	Yes	Yes	Yes	Yes	Yes

Maximum observed particle concentration (#/cc):	10.8
Data Quality Objective: max. allowable conc. (#/cc):	< 14
Does this meet the DQO:	Yes, (applies to all channels)

Test No. 10059906
 No Filter
 Solid-Phase

Particle Counts per Indicated OPC Channel (1-Minute Samples @ 7.1 L/min)

OPC Channel Number	1	2	3	4	5	6	7	8	9	10	11	12	13	14	15
Min. Diam. (um)	0.45	0.59	0.73	0.80	1.02	1.44	1.86	2.28	2.85	3.13	4.25	5.66	7.07	7.77	9.88
Max. Diam. (um)	0.59	0.73	0.80	1.02	1.44	1.86	2.28	2.85	3.13	4.25	5.66	7.07	7.77	9.88	14.10
Geo. Mean Diam (um)	0.52	0.66	0.77	0.90	1.21	1.64	2.06	2.55	2.98	3.65	4.91	6.33	7.41	8.76	11.81

ENTER DATA BELOW

U. Bckgrnd	1 Dif	10-05-1999	16:14:32	0.2 CF	2	0	0	0	0	0	0	0	0	0	0	0
U. Bckgrnd	1 Dif	10-05-1999	16:16:38	0.2 CF	3	0	0	0	0	0	0	0	0	0	0	0
Upstream	1 Dif	10-05-1999	16:20:50	0.2 CF	9968	8117	2186	6080	11948	4646	2819	2105	1064	3353	2134	1123
Upstream	1 Dif	10-05-1999	16:22:56	0.2 CF	10065	8023	2253	6187	11639	4617	2809	2129	1138	3378	2190	1147
Upstream	1 Dif	10-05-1999	16:25:02	0.2 CF	9993	8183	2177	6169	11532	4693	2813	2153	1125	3366	2126	1117
Upstream	1 Dif	10-05-1999	16:27:08	0.2 CF	10358	8578	2320	6408	11906	4657	2938	2182	1142	3609	2258	1125
Upstream	1 Dif	10-05-1999	16:29:14	0.2 CF	10185	8153	2239	6095	11812	4704	3013	2105	1150	3401	2079	1119
Upstream	1 Dif	10-05-1999	16:31:20	0.2 CF	9983	8133	2178	6145	11489	4501	2816	2104	1129	3414	2147	1152
Upstream	1 Dif	10-05-1999	16:33:26	0.2 CF	10149	8160	2201	6220	11629	4711	2775	2098	1098	3391	2199	1101
Upstream	1 Dif	10-05-1999	16:35:32	0.2 CF	10220	8272	2271	6267	12216	4741	3040	2084	1128	3487	2183	1127
Upstream	1 Dif	10-05-1999	16:37:38	0.2 CF	10379	8468	2263	6411	11941	4769	2987	2108	1133	3566	2208	1153
Upstream	1 Dif	10-05-1999	16:39:44	0.2 CF	10337	8343	2281	6301	11949	4803	2822	2202	1201	3664	2305	1170
U. Bckgrnd	1 Dif	10-05-1999	16:50:14	0.2 CF	0	0	0	0	0	0	0	0	0	0	0	0
U. Bckgrnd	1 Dif	10-05-1999	16:52:20	0.2 CF	1	0	0	0	0	0	0	0	0	0	0	0

ENTER DATA BELOW

D. Bckgrnd	2 Dif	10-05-1999	16:15:35	0.2 CF	3	1	0	1	0	0	0	1	0	0	0	0
Downstream	2 Dif	10-05-1999	16:21:53	0.2 CF	10408	8380	2257	6195	11836	4793	2895	2144	1166	3431	2190	
Downstream	2 Dif	10-05-1999	16:23:59	0.2 CF	10164	8133	2209	6247	11550	4494	2755	2171	1116	3471	2155	
Downstream	2 Dif	10-05-1999	16:26:05	0.2 CF	10365	8248	2203	6254	11755	4660	2859	2109	1179	3516	2285	
Downstream	2 Dif	10-05-1999	16:28:11	0.2 CF	9865	8255	2169	6337	11741	4609	2910	2046	1179	3508	2155	
Downstream	2 Dif	10-05-1999	16:30:17	0.2 CF	10125	8351	2118	6229	12002	4695	2862	2065	1122	3485	2217	
Downstream	2 Dif	10-05-1999	16:32:23	0.2 CF	10417	8136	2165	6260	11714	4606	2790	2183	1192	3529	2235	
Downstream	2 Dif	10-05-1999	16:34:29	0.2 CF	10488	8413	2214	6286	12093	4610	3045	2133	1153	3633	2227	
Downstream	2 Dif	10-05-1999	16:36:35	0.2 CF	10430	8690	2225	6403	12160	4888	2943	2080	1127	3609	2286	
Downstream	2 Dif	10-05-1999	16:38:41	0.2 CF	10294	8491	2270	6180	12320	4850	2922	2149	1209	3608	2229	
Downstream	2 Dif	10-05-1999	16:40:47	0.2 CF	10061	8355	2211	6219	11808	4708	2922	2179	1100	3537	2309	
D. Bckgrnd	2 Dif	10-05-1999	16:51:17	0.2 CF	0	0	0	0	0	0	0	0	0	0	0	

Meas. Penetration	1.01	1.01	0.99	1.01	1.01	1.00	1.00	1.00	1.02	1.02	1.02	1.01	0.99	0.97	0.97
P100 correction values	1.00	1.00	1.00	1.00	1.00	1.00	1.00	1.00	1.00	1.00	1.00	1.00	1.00	1.00	1.00
Corrected Penetration	1.01	1.01	0.99	1.01	1.01	1.00	1.00	1.00	1.02	1.02	1.02	1.01	0.99	0.97	0.97
Corrected Efficiency (%)	-1	-1	1	-1	-1	0	0	0	-2	-2	-2	-1	1	3	3

Data Acceptance Criteria:

Total Challenge Counts for Each Channel:	101637	82430	22369	62283	118061	46842	28832	21270	11308	34629	21829	11334	4635	8588	6217
Data Quality Objective:	> 500	> 500	> 500	> 500	> 500	> 500	> 500	> 500	> 500	> 500	> 500	> 500	> 500	> 500	> 500
Does this meet DQO:	Yes	Yes	Yes	Yes	Yes	Yes	Yes	Yes	Yes	Yes	Yes	Yes	Yes	Yes	Yes

Standard Deviation of Penetration for Each Channel :	0.03	0.03	0.03	0.02	0.03	0.03	0.04	0.03	0.05	0.04	0.04	0.04	0.06	0.06	0.05
Data Quality Objective:	<0.10	<0.10	<0.10	<0.10	<0.10	<0.10	<0.10	<0.10	<0.10	<0.30	<0.30	<0.30	<0.30	<0.30	<0.30
Does this meet DQO:	Yes	Yes	Yes	Yes	Yes	Yes	Yes	Yes	Yes	Yes	Yes	Yes	Yes	Yes	Yes

Maximum observed particle concentration (#/cc):	10.8
Data Quality Objective: max. allowable conc. (#/cc):	< 14
Does this meet the DQO:	Yes, (applies to all channels)

Test No. 10069901

Arrestor
Solid-Phase

Particle Counts per Indicated OPC Channel (1-Minute Samples @ 7.1 L/min)

OPC Channel Number	1	2	3	4	5	6	7	8	9	10	11	12	13	14	15
Min. Diam. (um)	0.45	0.59	0.73	0.80	1.02	1.44	1.86	2.28	2.85	3.13	4.25	5.66	7.07	7.77	9.88
Max. Diam. (um)	0.59	0.73	0.80	1.02	1.44	1.86	2.28	2.85	3.13	4.25	5.66	7.07	7.77	9.88	14.10
Geo. Mean Diam (um)	0.52	0.66	0.77	0.90	1.21	1.64	2.06	2.55	2.98	3.65	4.91	6.33	7.41	8.76	11.81

ENTER DATA BELOW

U. Bckgrnd	1 Dif	10-06-1999	08:55:06	0.2 CF	0	0	0	0	0	0	0	0	0	0	0	0			
U. Bckgrnd	1 Dif	10-06-1999	08:57:12	0.2 CF	1	0	0	0	0	0	0	0	0	0	0	0			
Upstream	1 Dif	10-06-1999	09:02:33	0.2 CF	9867	7932	2163	5964	11389	4760	2999	2183	1101	3455	2207	1181	431	873	700
Upstream	1 Dif	10-06-1999	09:04:39	0.2 CF	10426	8009	2152	6082	11763	4841	3039	2229	1171	3637	2331	1213	508	942	704
Upstream	1 Dif	10-06-1999	09:06:45	0.2 CF	10229	8330	2240	6137	11721	4854	3089	2331	1190	3703	2381	1209	493	919	716
Upstream	1 Dif	10-06-1999	09:08:51	0.2 CF	10200	8326	2255	6240	11891	4884	3092	2280	1186	3635	2368	1173	488	930	688
Upstream	1 Dif	10-06-1999	09:10:57	0.2 CF	10364	8078	2185	6316	11811	4863	3041	2271	1178	3552	2332	1240	495	926	683
Upstream	1 Dif	10-06-1999	09:13:03	0.2 CF	10209	8112	2219	6031	11960	5032	3067	2237	1166	3490	2334	1189	517	895	719
Upstream	1 Dif	10-06-1999	09:15:09	0.2 CF	9930	7913	2139	5915	11338	4736	2958	2067	1178	3632	2305	1260	474	840	691
Upstream	1 Dif	10-06-1999	09:17:15	0.2 CF	10014	7880	2136	5966	11194	4535	2953	2199	1159	3501	2286	1096	500	864	711
Upstream	1 Dif	10-06-1999	09:19:21	0.2 CF	9853	7871	2176	5924	11323	4692	2801	2059	1162	3470	2259	1170	470	901	709
Upstream	1 Dif	10-06-1999	09:21:27	0.2 CF	9953	8044	2130	6042	11451	4664	2828	2138	1138	3535	2350	1242	463	906	686
U. Bckgrnd	1 Dif	10-06-1999	09:34:47	0.2 CF	0	0	0	0	0	0	0	0	0	0	0	0	0	0	0
U. Bckgrnd	1 Dif	10-06-1999	09:36:53	0.2 CF	0	0	0	0	0	0	0	0	0	0	0	0	0	0	0

ENTER DATA BELOW

D. Bckgrnd	2 Dif	10-06-1999	08:56:09	0.2 CF	3	1	0	1	1	0	0	0	0	0	0	0	0	0	0
Downstream	2 Dif	10-06-1999	09:03:36	0.2 CF	2349	1297	323	567	670	131	45	17	15	21	5	0	0	2	0
Downstream	2 Dif	10-06-1999	09:05:42	0.2 CF	2459	1314	268	567	696	150	49	22	8	14	4	5	0	1	1
Downstream	2 Dif	10-06-1999	09:07:48	0.2 CF	2396	1312	265	603	649	122	54	24	11	13	4	4	2	2	0
Downstream	2 Dif	10-06-1999	09:09:54	0.2 CF	2331	1350	274	552	658	138	45	22	11	17	6	2	1	3	1
Downstream	2 Dif	10-06-1999	09:12:00	0.2 CF	2274	1354	259	519	726	118	38	16	9	17	9	0	0	1	2
Downstream	2 Dif	10-06-1999	09:14:06	0.2 CF	2326	1295	265	582	631	125	55	15	9	17	4	2	2	0	0
Downstream	2 Dif	10-06-1999	09:16:12	0.2 CF	2326	1290	249	541	689	120	35	17	8	19	6	3	0	2	4
Downstream	2 Dif	10-06-1999	09:18:18	0.2 CF	2303	1254	269	578	704	121	48	19	11	16	3	1	2	2	1
Downstream	2 Dif	10-06-1999	09:20:24	0.2 CF	2209	1249	265	558	662	123	48	21	7	16	2	4	1	2	0
Downstream	2 Dif	10-06-1999	09:22:30	0.2 CF	2302	1251	232	543	699	149	39	15	6	19	4	2	2	0	0
D. Bckgrnd	2 Dif	10-06-1999	09:35:50	0.2 CF	8	6	0	1	5	0	1	0	0	2	0	0	0	0	0

Meas. Penetration	0.23	0.16	0.12	0.09	0.06	0.03	0.02	0.01	0.01	0.00	0.00	0.00	0.00	0.00	0.00	0.00
P100 correction values	1.01	1.01	0.99	1.01	1.01	1.00	1.00	1.00	1.02	1.02	1.02	1.01	0.99	0.97	0.97	
Corrected Penetration	0.23	0.16	0.12	0.09	0.06	0.03	0.02	0.01	0.01	0.00	0.00	0.00	0.00	0.00		
Corrected Efficiency (%)	77	84	88	91	94	97	98	99	99	100	100	100	100	100		

Data Acceptance Criteria:

Total Challenge Counts for Each Channel:	101045	80495	21795	60617	115841	47861	29867	21994	11629	35610	23153	11973	4839	8996	7007
Data Quality Objective:	> 500	> 500	> 500	> 500	> 500	> 500	> 500	> 500	> 500	> 500	> 500	> 500	> 500	> 500	> 500
Does this meet DQO:	Yes	Yes	Yes	Yes	Yes	Yes	Yes	Yes	Yes	Yes	Yes	Yes	Yes	Yes	Yes

Standard Deviation of Penetration for Each Channel :	0.01	0.01	0.01	0.00	0.00	0.00	0.00	0.00	0.00	0.00	0.00	0.00	0.00	0.00	0.00
Data Quality Objective:	<0.10	<0.10	<0.10	<0.10	<0.10	<0.10	<0.10	<0.10	<0.10	<0.30	<0.30	<0.30	<0.30	<0.30	<0.30
Does this meet DQO:	Yes	Yes	Yes	Yes	Yes	Yes	Yes	Yes	Yes	Yes	Yes	Yes	Yes	Yes	Yes

Maximum observed particle concentration (#/cc): 10.8
 Data Quality Objective: max. allowable conc. (#/cc): < 14
 Does this meet the DQO: Yes, (applies to all channels)

Test No. 10069902

No Filter
Solid-Phase

Particle Counts per Indicated OPC Channel (1-Minute Samples @ 7.1 L/min)

OPC Channel Number	1	2	3	4	5	6	7	8	9	10	11	12	13	14	15
Min. Diam. (um)	0.45	0.59	0.73	0.80	1.02	1.44	1.86	2.28	2.85	3.13	4.25	5.66	7.07	7.77	9.88
Max. Diam. (um)	0.59	0.73	0.80	1.02	1.44	1.86	2.28	2.85	3.13	4.25	5.66	7.07	7.77	9.88	14.10
Geo. Mean Diam (um)	0.52	0.66	0.77	0.90	1.21	1.64	2.06	2.55	2.98	3.65	4.91	6.33	7.41	8.76	11.81

ENTER DATA BELOW

U. Bckgrnd	1 Dif	10-06-1999	09:51:35	0.2 CF	1	0	0	0	0	0	0	0	0	0	0	0			
U. Bckgrnd	1 Dif	10-06-1999	09:53:41	0.2 CF	0	0	0	0	0	0	0	0	0	0	0	0			
Upstream	1 Dif	10-06-1999	09:58:59	0.2 CF	9722	7770	2043	5797	11085	4427	2696	2134	1082	3373	2155	1117	459	895	611
Upstream	1 Dif	10-06-1999	10:01:05	0.2 CF	9496	7585	2088	5843	11013	4554	2716	2064	1045	3300	2187	1116	494	918	669
Upstream	1 Dif	10-06-1999	10:03:11	0.2 CF	9553	7745	1975	5812	11281	4402	2799	2167	1115	3407	2129	1159	498	821	731
Upstream	1 Dif	10-06-1999	10:05:17	0.2 CF	9389	7648	2024	5733	11054	4418	2758	1973	1128	3347	2237	1132	511	832	652
Upstream	1 Dif	10-06-1999	10:07:23	0.2 CF	9916	7731	2008	5797	11172	4538	2730	2119	1139	3334	2250	1154	466	877	695
Upstream	1 Dif	10-06-1999	10:09:29	0.2 CF	9691	7772	2094	5809	11223	4636	2801	2069	1068	3409	2227	1244	435	939	727
Upstream	1 Dif	10-06-1999	10:11:35	0.2 CF	9606	7783	2085	5862	11254	4506	2825	2069	1100	3415	2168	1192	453	905	722
Upstream	1 Dif	10-06-1999	10:13:41	0.2 CF	9780	7855	2131	6005	11603	4656	2863	2160	1189	3410	2240	1115	501	897	660
Upstream	1 Dif	10-06-1999	10:15:47	0.2 CF	9837	7794	2114	5903	11217	4558	2696	2118	1168	3404	2276	1093	468	831	665
Upstream	1 Dif	10-06-1999	10:17:53	0.2 CF	9609	7356	2103	5651	10970	4405	2728	2030	1054	3259	2162	1135	448	821	690
U. Bckgrnd	1 Dif	10-06-1999	10:28:23	0.2 CF	3	0	0	0	0	0	0	0	0	0	0	0	0	0	0
U. Bckgrnd	1 Dif	10-06-1999	10:30:29	0.2 CF	4	1	0	0	0	0	0	0	0	0	0	0	0	0	0

ENTER DATA BELOW

D. Bckgrnd	2 Dif	10-06-1999	09:52:38	0.2 CF	0	0	0	0	1	0	0	0	0	0	0	0	0	0	0
Downstream	2 Dif	10-06-1999	10:00:02	0.2 CF	9643	7581	2123	5863	10993	4516	2812	2040	1037	3274	2117	1113	438	734	566
Downstream	2 Dif	10-06-1999	10:02:08	0.2 CF	9497	7643	2049	5768	11067	4487	2741	1986	1092	3406	2171	1148	425	836	603
Downstream	2 Dif	10-06-1999	10:04:14	0.2 CF	9662	7716	2014	5772	11208	4449	2742	1972	1105	3412	2218	1128	413	793	573
Downstream	2 Dif	10-06-1999	10:06:20	0.2 CF	9488	7689	2068	5761	10907	4379	2746	2073	1113	3549	2232	1115	412	793	590
Downstream	2 Dif	10-06-1999	10:08:26	0.2 CF	9725	7629	2046	5876	11249	4706	2783	2086	1121	3283	2155	1111	459	815	586
Downstream	2 Dif	10-06-1999	10:10:32	0.2 CF	9638	7762	2129	5806	11202	4484	2902	2086	1141	3290	2219	1124	416	768	570
Downstream	2 Dif	10-06-1999	10:12:38	0.2 CF	9975	7975	2066	5979	11418	4738	2940	2151	1121	3386	2254	1085	443	730	534
Downstream	2 Dif	10-06-1999	10:14:44	0.2 CF	9932	7817	2082	5993	11408	4657	2991	2095	1067	3529	2199	1119	449	790	570
Downstream	2 Dif	10-06-1999	10:16:50	0.2 CF	9555	7603	2019	5715	10930	4521	2686	2032	1154	3386	2138	1019	436	763	591
Downstream	2 Dif	10-06-1999	10:18:56	0.2 CF	9575	7739	2078	5785	10865	4490	2743	2063	1053	3363	2174	1057	434	777	566
D. Bckgrnd	2 Dif	10-06-1999	10:29:26	0.2 CF	11	0	0	0	0	0	0	0	0	0	0	0	0	0	0

Meas. Penetration	1.00	1.00	1.00	1.00	0.99	1.01	1.02	0.98	0.99	1.01	0.99	0.96	0.91	0.89	0.84
P100 correction values	1.00	1.00	1.00	1.00	1.00	1.00	1.00	1.00	1.00	1.00	1.00	1.00	1.00	1.00	1.00
Corrected Penetration	1.00	1.00	1.00	1.00	0.99	1.01	1.02	0.98	0.99	1.01	0.99	0.96	0.91	0.89	0.84
Corrected Efficiency (%)	0	0	0	0	1	-1	-2	2	1	-1	1	4	9	11	16

Data Acceptance Criteria:

Total Challenge Counts for Each Channel:	96599	77039	20665	58212	111872	45100	27612	20903	11088	33658	22031	11457	4733	8736	6822
Data Quality Objective:	> 500	> 500	> 500	> 500	> 500	> 500	> 500	> 500	> 500	> 500	> 500	> 500	> 500	> 500	> 500
Does this meet DQO:	Yes	Yes	Yes	Yes	Yes	Yes	Yes	Yes	Yes	Yes	Yes	Yes	Yes	Yes	Yes

Standard Deviation of Penetration for Each Channel :	0.02	0.02	0.03	0.02	0.02	0.03	0.04	0.04	0.06	0.03	0.03	0.05	0.06	0.06	0.05
Data Quality Objective:	<0.10	<0.10	<0.10	<0.10	<0.10	<0.10	<0.10	<0.10	<0.10	<0.30	<0.30	<0.30	<0.30	<0.30	<0.30
Does this meet DQO:	Yes	Yes	Yes	Yes	Yes	Yes	Yes	Yes	Yes	Yes	Yes	Yes	Yes	Yes	Yes

Maximum observed particle concentration (#/cc): 10.4
 Data Quality Objective: max. allowable conc. (#/cc): < 14
 Does this meet the DQO: Yes, (applies to all channels)

Test No. 10069903
 Arrestor
 Solid-Phase

Particle Counts per Indicated OPC Channel (1-Minute Samples @ 7.1 L/min)

OPC Channel Number	1	2	3	4	5	6	7	8	9	10	11	12	13	14	15
Min. Diam. (um)	0.45	0.59	0.73	0.80	1.02	1.44	1.86	2.28	2.85	3.13	4.25	5.66	7.07	7.77	9.88
Max. Diam. (um)	0.59	0.73	0.80	1.02	1.44	1.86	2.28	2.85	3.13	4.25	5.66	7.07	7.77	9.88	14.10
Geo. Mean Diam (um)	0.52	0.66	0.77	0.90	1.21	1.64	2.06	2.55	2.98	3.65	4.91	6.33	7.41	8.76	11.81

ENTER DATA BELOW

U. Bckgrnd	1 Dif	10-06-1999 10:44:13	0.2 CF	3	0	0	0	0	0	0	0	0	0	0	0	0		
U. Bckgrnd	1 Dif	10-06-1999 10:46:19	0.2 CF	2	0	0	0	0	0	0	0	0	0	0	0	0		
Upstream	1 Dif	10-06-1999 10:51:39	0.2 CF	9964	7957	2151	5975	11328	4611	2814	2163	1141	3517	2217	1130	481	935	692
Upstream	1 Dif	10-06-1999 10:53:45	0.2 CF	9934	8034	2269	6153	11626	4584	2906	2162	1167	3602	2196	1195	493	918	748
Upstream	1 Dif	10-06-1999 10:55:51	0.2 CF	10040	8068	2121	6176	11546	4587	2819	2169	1189	3550	2212	1170	503	907	671
Upstream	1 Dif	10-06-1999 10:57:57	0.2 CF	9876	8044	2071	6034	11563	4778	2907	2150	1139	3520	2280	1199	480	913	741
Upstream	1 Dif	10-06-1999 11:00:03	0.2 CF	9960	7933	2112	6200	11459	4708	2792	2090	1133	3440	2272	1168	468	860	732
Upstream	1 Dif	10-06-1999 11:02:09	0.2 CF	9982	8144	2182	6109	11645	4639	2838	2152	1184	3472	2217	1117	486	938	700
Upstream	1 Dif	10-06-1999 11:04:15	0.2 CF	10201	8030	2245	6192	11493	4632	2853	2163	1101	3469	2250	1189	530	935	669
Upstream	1 Dif	10-06-1999 11:06:21	0.2 CF	9926	8043	2176	5926	11480	4614	2811	2127	1168	3448	2271	1176	450	880	654
Upstream	1 Dif	10-06-1999 11:08:27	0.2 CF	9919	7852	2099	6103	11455	4649	2788	2083	1135	3367	2228	1200	432	890	699
Upstream	1 Dif	10-06-1999 11:10:33	0.2 CF	9516	7837	2100	5968	11242	4635	2771	2111	1148	3497	2264	1159	506	877	700
U. Bckgrnd	1 Dif	10-06-1999 11:18:57	0.2 CF	3	0	0	0	0	0	0	0	0	0	0	0	0	0	0
U. Bckgrnd	1 Dif	10-06-1999 11:21:03	0.2 CF	3	1	0	0	0	0	0	0	0	0	0	0	0	0	0

ENTER DATA BELOW

D. Bckgrnd	2 Dif	10-06-1999 10:45:16	0.2 CF	8	3	1	1	0	0	0	0	0	0	0	0	0	0	0
Downstream	2 Dif	10-06-1999 10:52:42	0.2 CF	1946	1044	196	448	463	102	25	12	5	14	8	4	2	4	0
Downstream	2 Dif	10-06-1999 10:54:48	0.2 CF	1976	1081	204	401	522	97	22	12	7	22	6	4	3	3	1
Downstream	2 Dif	10-06-1999 10:56:54	0.2 CF	1929	1013	226	436	479	86	38	12	10	13	6	3	0	2	2
Downstream	2 Dif	10-06-1999 10:59:00	0.2 CF	1980	1024	210	438	442	88	33	13	5	16	4	3	2	2	1
Downstream	2 Dif	10-06-1999 11:01:06	0.2 CF	1867	938	222	386	441	72	27	14	5	14	8	3	2	1	2
Downstream	2 Dif	10-06-1999 11:03:12	0.2 CF	1867	1045	240	463	467	94	24	17	5	12	9	4	1	4	2
Downstream	2 Dif	10-06-1999 11:05:18	0.2 CF	1910	1011	224	460	462	75	28	17	8	16	6	3	2	1	2
Downstream	2 Dif	10-06-1999 11:07:24	0.2 CF	1977	1045	185	421	451	67	28	7	8	17	11	1	2	3	0
Downstream	2 Dif	10-06-1999 11:09:30	0.2 CF	1945	982	199	436	457	98	26	12	8	24	3	3	0	4	2
Downstream	2 Dif	10-06-1999 11:11:36	0.2 CF	1789	968	200	421	466	72	33	9	6	17	6	1	1	0	1
D. Bckgrnd	2 Dif	10-06-1999 11:20:00	0.2 CF	5	5	2	0	0	0	0	0	0	0	0	0	0	0	0

Meas. Penetration	0.19	0.13	0.10	0.07	0.04	0.02	0.01	0.01	0.01	0.01	0.00	0.00	0.00	0.00	0.00	0.00
P100 correction values	1.00	1.00	1.00	1.00	0.99	1.01	1.02	0.98	0.99	1.01	0.99	0.96	0.91	0.89	0.84	
Corrected Penetration	0.19	0.13	0.10	0.07	0.04	0.02	0.01	0.01	0.01	0.00	0.00	0.00	0.00	0.00	0.00	
Corrected Efficiency (%)	81	87	90	93	96	98	99	99	99	100	100	100	100	100	100	

Data Acceptance Criteria:

Total Challenge Counts for Each Channel:	99318	79942	21526	60836	114837	46437	28299	21370	11505	34882	22407	11703	4829	9053	7006
Data Quality Objective:	> 500	> 500	> 500	> 500	> 500	> 500	> 500	> 500	> 500	> 500	> 500	> 500	> 500	> 500	> 500
Does this meet DQO:	Yes	Yes	Yes	Yes	Yes	Yes	Yes	Yes	Yes	Yes	Yes	Yes	Yes	Yes	Yes

Standard Deviation of Penetration for Each Channel :

Data Quality Objective:	<0.10	<0.10	<0.10	<0.10	<0.10	<0.10	<0.10	<0.10	<0.10	<0.10	<0.30	<0.30	<0.30	<0.30	<0.30	<0.30
Does this meet DQO:	Yes	Yes	Yes	Yes	Yes	Yes	Yes	Yes	Yes	Yes	Yes	Yes	Yes	Yes	Yes	Yes

Maximum observed particle concentration (#/cc):	10.5
Data Quality Objective: max. allowable conc. (#/cc):	< 14
Does this meet the DQO:	Yes, (applies to all channels)

Test No. 10059902
HEPA
Solid-Phase

Particle Counts per Indicated OPC Channel (1-Minute Samples @ 7.1 L/min)

OPC Channel Number	1	2	3	4	5	6	7	8	9	10	11	12	13	14	15
Min. Diam. (um)	0.45	0.59	0.73	0.80	1.02	1.44	1.86	2.28	2.85	3.13	4.25	5.66	7.07	7.77	9.88
Max. Diam. (um)	0.59	0.73	0.80	1.02	1.44	1.86	2.28	2.85	3.13	4.25	5.66	7.07	7.77	9.88	14.10
Geo. Mean Diam (um)	0.52	0.66	0.77	0.90	1.21	1.64	2.06	2.55	2.98	3.65	4.91	6.33	7.41	8.76	11.81

ENTER DATA BELOW

U. Bckgrnd	1 Dif	10-05-1999	11:37:49	0.2 CF	4	0	0	0	0	0	0	0	0	0	0	0			
U. Bckgrnd	1 Dif	10-05-1999	11:39:55	0.2 CF	4	0	0	0	0	0	0	0	0	0	0	0			
Upstream	1 Dif	10-05-1999	11:44:07	0.2 CF	9653	7944	2123	5980	11262	4597	2770	2053	1111	3400	2179	1114	410	827	585
Upstream	1 Dif	10-05-1999	11:46:13	0.2 CF	9648	7858	2087	5990	11344	4527	2758	2071	1186	3464	2116	1045	484	824	619
Upstream	1 Dif	10-05-1999	11:48:19	0.2 CF	10140	8246	2078	6124	11836	4773	2855	2059	1182	3478	2209	1193	511	901	662
Upstream	1 Dif	10-05-1999	11:50:25	0.2 CF	10118	8385	2240	6274	11853	4741	2863	2119	1148	3477	2222	1169	510	864	668
Upstream	1 Dif	10-05-1999	11:52:31	0.2 CF	10058	8216	2254	6160	11874	4684	2975	2120	1119	3572	2213	1225	430	856	601
Upstream	1 Dif	10-05-1999	11:54:37	0.2 CF	10401	8389	2206	6369	12131	4793	3036	2221	1230	3586	2135	1268	421	895	602
Upstream	1 Dif	10-05-1999	11:56:43	0.2 CF	9930	8305	2099	6098	11600	4652	2764	2035	1101	3377	2173	1160	447	857	664
Upstream	1 Dif	10-05-1999	11:58:49	0.2 CF	9844	8047	2045	6206	11681	4488	2773	2224	1078	3518	2248	1138	477	850	660
Upstream	1 Dif	10-05-1999	12:00:55	0.2 CF	9979	8065	2165	6176	11467	4519	2825	2067	1099	3396	2208	1171	471	814	660
Upstream	1 Dif	10-05-1999	12:03:01	0.2 CF	9771	8049	2095	6146	11736	4626	2798	2047	1089	3466	2080	1168	428	835	620
U. Bckgrnd	1 Dif	10-05-1999	12:11:25	0.2 CF	1	1	0	0	0	0	0	0	0	0	0	0	0	0	0
U. Bckgrnd	1 Dif	10-05-1999	12:13:31	0.2 CF	0	0	0	0	0	0	0	0	0	0	0	0	0	0	0

ENTER DATA BELOW

D. Bckgrnd	2 Dif	10-05-1999	11:38:52	0.2 CF	3	0	0	0	0	0	0	0	0	0	0	0	0	0	0
Downstream	2 Dif	10-05-1999	11:45:10	0.2 CF	16	9	3	13	6	3	1	5	1	4	2	3	0	0	0
Downstream	2 Dif	10-05-1999	11:47:16	0.2 CF	14	10	0	10	14	3	1	1	2	3	0	1	0	0	0
Downstream	2 Dif	10-05-1999	11:49:22	0.2 CF	13	12	4	8	14	8	2	0	1	3	2	0	0	1	1
Downstream	2 Dif	10-05-1999	11:51:28	0.2 CF	12	11	1	10	15	3	5	3	2	3	2	4	1	0	2
Downstream	2 Dif	10-05-1999	11:53:34	0.2 CF	20	13	3	6	13	5	3	4	1	1	2	1	0	0	0
Downstream	2 Dif	10-05-1999	11:55:40	0.2 CF	11	8	5	13	17	5	2	4	0	2	1	2	0	0	0
Downstream	2 Dif	10-05-1999	11:57:46	0.2 CF	18	9	3	4	18	5	2	3	0	4	2	1	0	0	0
Downstream	2 Dif	10-05-1999	11:59:52	0.2 CF	13	10	6	5	12	4	5	0	3	3	3	0	0	0	0
Downstream	2 Dif	10-05-1999	12:01:58	0.2 CF	15	10	0	10	5	4	2	1	0	3	0	0	1	1	0
Downstream	2 Dif	10-05-1999	12:04:04	0.2 CF	21	10	2	13	13	4	5	1	0	1	0	0	0	1	0
D. Bckgrnd	2 Dif	10-05-1999	12:12:28	0.2 CF	0	0	0	0	0	0	0	0	0	0	0	0	0	0	0

Meas. Penetration	0.00	0.00	0.00	0.00	0.00	0.00	0.00	0.00	0.00	0.00	0.00	0.00	0.00	0.00	0.00	0.00	0.00	0.00	0.00
P100 correction values	1.00	1.00	1.00	1.00	1.01	1.00	1.02	1.00	1.00	1.01	1.01	0.99	0.98	0.98	0.97				
Corrected Penetration	0.00	0.00	0.00	0.00	0.00	0.00	0.00	0.00	0.00	0.00	0.00	0.00	0.00	0.00	0.00	0.00	0.00	0.00	0.00
Corrected Efficiency (%)	100	100	100	100	100	100	100	100	100	100	100	100	100	100	100	100	100	100	100

Data Acceptance Criteria:

Total Challenge Counts for Each Channel:	99542	81504	21392	61523	116784	46400	28417	21016	11343	34734	21783	11651	4589	8523	6341
Data Quality Objective:	> 500	> 500	> 500	> 500	> 500	> 500	> 500	> 500	> 500	> 500	> 500	> 500	> 500	> 500	> 500
Does this meet DQO:	Yes	Yes	Yes	Yes	Yes	Yes	Yes	Yes	Yes	Yes	Yes	Yes	Yes	Yes	Yes

Standard Deviation of Penetration for Each Channel :	0.00	0.00	0.00	0.00	0.00	0.00	0.00	0.00	0.00	0.00	0.00	0.00	0.00	0.00	0.00
Data Quality Objective:	<0.10	<0.10	<0.10	<0.10	<0.10	<0.10	<0.10	<0.10	<0.10	<0.30	<0.30	<0.30	<0.30	<0.30	<0.30
Does this meet DQO:	Yes	Yes	Yes	Yes	Yes	Yes	Yes	Yes	Yes	Yes	Yes	Yes	Yes	Yes	Yes

Maximum observed particle concentration (#/cc):	10.8
Data Quality Objective: max. allowable conc. (#/cc):	< 14
Does this meet the DQO:	Yes, (applies to all channels)

Test No. 10089904
 No Filter
 Liquid-Phase

Particle Counts per Indicated OPC Channel (1-Minute Samples @ 7.1 L/min)

OPC Channel Number	1	2	3	4	5	6	7	8	9	10	11	12	13	14	15
Min. Diam. (um)	0.28	0.37	0.47	0.52	0.66	0.94	1.22	1.51	1.88	2.07	2.83	3.77	4.71	5.18	6.60
Max. Diam. (um)	0.37	0.47	0.52	0.66	0.94	1.22	1.51	1.88	2.07	2.83	3.77	4.71	5.18	6.60	9.43
Geo. Mean Diam (um)	0.32	0.42	0.49	0.58	0.78	1.07	1.36	1.68	1.97	2.42	3.26	4.21	4.94	5.85	7.89

ENTER DATA BELOW

U. Bckgrnd	1 Dif	10-08-1999 10:38:12	0.2 CF	3	0	0	0	0	0	0	0	0	0	0	0	0		
U. Bckgrnd	1 Dif	10-08-1999 10:40:18	0.2 CF	0	0	0	0	0	0	0	0	0	0	0	0	0		
Upstream	1 Dif	10-08-1999 10:44:30	0.2 CF	9642	7174	2123	5027	12035	6901	4627	4223	2766	7492	2888	1413	658	978	420
Upstream	1 Dif	10-08-1999 10:46:36	0.2 CF	9985	7596	2161	5320	12806	7070	4757	4244	2764	7659	2858	1454	608	1126	426
Upstream	1 Dif	10-08-1999 10:48:42	0.2 CF	10075	7589	2152	5167	12881	7414	4736	4279	2815	7946	2952	1416	658	1121	423
Upstream	1 Dif	10-08-1999 10:50:48	0.2 CF	9729	7378	2102	5221	12849	6996	4750	4161	2791	7618	2858	1444	593	1043	383
Upstream	1 Dif	10-08-1999 10:52:54	0.2 CF	9990	7796	2118	5295	13135	7293	4795	4320	2896	7913	2846	1549	604	1105	395
Upstream	1 Dif	10-08-1999 10:55:00	0.2 CF	10017	7593	2171	5223	12941	6929	4753	4236	2838	7807	2879	1408	627	1090	413
Upstream	1 Dif	10-08-1999 10:57:06	0.2 CF	9908	7600	2143	5311	12978	7206	4751	4393	2836	7841	2891	1466	642	1066	444
Upstream	1 Dif	10-08-1999 10:59:12	0.2 CF	10028	7940	2099	5311	13030	7220	4775	4343	2914	7870	2919	1472	639	1083	426
Upstream	1 Dif	10-08-1999 11:01:18	0.2 CF	10015	7858	2161	5256	12946	7243	4865	4359	2964	7913	3022	1502	639	1107	425
Upstream	1 Dif	10-08-1999 11:03:24	0.2 CF	9892	7662	2160	5457	13018	7157	4704	4252	2877	7661	2922	1362	614	1111	450
U. Bckgrnd	1 Dif	10-08-1999 11:14:19	0.2 CF	0	0	0	0	0	0	0	0	0	0	0	0	0	0	0
U. Bckgrnd	1 Dif	10-08-1999 11:16:25	0.2 CF	0	0	0	0	0	0	0	0	0	0	0	0	0	0	0

ENTER DATA BELOW

D. Bckgrnd	2 Dif	10-08-1999 10:39:15	0.2 CF	2	0	0	0	0	0	0	0	0	0	0	0	0	0	0
Downstream	2 Dif	10-08-1999 10:45:33	0.2 CF	9803	7557	2075	5255	12594	7081	4747	4255	2852	7631	2904	1467	589	1030	368
Downstream	2 Dif	10-08-1999 10:47:39	0.2 CF	9741	7412	1970	5227	12573	6986	4679	4247	2901	7635	2888	1402	628	1058	370
Downstream	2 Dif	10-08-1999 10:49:45	0.2 CF	9878	7434	2032	5232	12712	7003	4816	4193	2779	7651	2805	1402	599	1041	369
Downstream	2 Dif	10-08-1999 10:51:51	0.2 CF	9864	7576	2029	5187	12670	7085	4794	4268	2909	7798	2891	1425	623	1101	341
Downstream	2 Dif	10-08-1999 10:53:57	0.2 CF	9915	7741	2088	5303	13055	7204	4811	4265	2867	7786	2990	1528	698	1065	344
Downstream	2 Dif	10-08-1999 10:56:03	0.2 CF	9852	7369	2162	5152	12708	7067	4595	4219	2834	7714	2919	1491	624	1036	394
Downstream	2 Dif	10-08-1999 10:58:09	0.2 CF	10069	7619	2184	5293	13094	7269	4938	4424	2949	7958	3036	1449	672	1110	351
Downstream	2 Dif	10-08-1999 11:00:15	0.2 CF	9706	7544	2016	5259	12684	7206	4790	4285	2867	7802	2976	1509	608	1048	364
Downstream	2 Dif	10-08-1999 11:02:21	0.2 CF	9814	7713	2107	5380	12868	7105	4731	4355	2834	7710	2934	1452	649	1121	364
Downstream	2 Dif	10-08-1999 11:04:27	0.2 CF	9800	7507	2099	5136	12775	7093	4818	4253	2869	7747	2957	1509	678	1086	368
D. Bckgrnd	2 Dif	10-08-1999 11:15:22	0.2 CF	0	0	0	0	0	0	0	0	0	0	0	0	0	0	0

Meas. Penetration	0.99	0.99	0.97	1.00	0.99	1.00	1.00	1.00	1.00	1.01	1.00	1.01	1.01	1.01	0.99	0.86
P100 correction values	1.00	1.00	1.00	1.00	1.00	1.00	1.00	1.00	1.00	1.00	1.00	1.00	1.00	1.00	1.00	1.00
Corrected Penetration	0.99	0.99	0.97	1.00	0.99	1.00	1.00	1.00	1.00	1.01	1.00	1.01	1.01	1.01	0.99	0.86
Corrected Efficiency (%)	1	1	3	0	1	0	0	0	0	-1	0	-1	-1	-1	1	14

Data Acceptance Criteria:

Total Challenge Counts for Each Channel:	99281	76186	21390	52588	128619	71429	47513	42810	28461	77720	29035	14486	6282	10830	4205
Data Quality Objective:	> 500	> 500	> 500	> 500	> 500	> 500	> 500	> 500	> 500	> 500	> 500	> 500	> 500	> 500	> 500
Does this meet DQO:	Yes	Yes	Yes	Yes	Yes	Yes	Yes	Yes	Yes	Yes	Yes	Yes	Yes	Yes	Yes

Standard Deviation of Penetration for Each Channel :	0.02	0.03	0.03	0.03	0.03	0.03	0.02	0.02	0.03	0.02	0.03	0.05	0.07	0.05	0.05
Data Quality Objective:	<0.10	<0.10	<0.10	<0.10	<0.10	<0.10	<0.10	<0.10	<0.10	<0.10	<0.30	<0.30	<0.30	<0.30	<0.30
Does this meet DQO:	Yes	Yes	Yes	Yes	Yes	Yes	Yes	Yes	Yes	Yes	Yes	Yes	Yes	Yes	Yes

Maximum observed particle concentration (#/cc):	13.1
Data Quality Objective: max. allowable conc. (#/cc):	< 14
Does this meet the DQO:	Yes, (applies to all channels)

Test No. 10089905

Arrestor

Liquid-Phase

Particle Counts per Indicated OPC Channel (1-Minute Samples @ 7.1 L/min)

OPC Channel Number	1	2	3	4	5	6	7	8	9	10	11	12	13	14	15
Min. Diam. (um)	0.28	0.37	0.47	0.52	0.66	0.94	1.22	1.51	1.88	2.07	2.83	3.77	4.71	5.18	6.60
Max. Diam. (um)	0.37	0.47	0.52	0.66	0.94	1.22	1.51	1.88	2.07	2.83	3.77	4.71	5.18	6.60	9.43
Geo. Mean Diam (um)	0.32	0.42	0.49	0.58	0.78	1.07	1.36	1.68	1.97	2.42	3.26	4.21	4.94	5.85	7.89

ENTER DATA BELOW

U. Bckgrnd	1 Dif	10-08-1999	11:31:07	0.2 CF	4	1	0	0	0	0	0	0	0	0	0	0			
U. Bckgrnd	1 Dif	10-08-1999	11:33:13	0.2 CF	2	0	0	0	0	0	0	0	0	0	0	0			
Upstream	1 Dif	10-08-1999	11:37:25	0.2 CF	9875	7570	2144	5350	12828	6926	4985	4410	2835	7484	2961	1459	604	1091	380
Upstream	1 Dif	10-08-1999	11:39:31	0.2 CF	9888	7572	2191	5342	13019	6948	4824	4347	2697	7703	2839	1459	647	1127	421
Upstream	1 Dif	10-08-1999	11:41:37	0.2 CF	9933	7690	2098	5272	12820	6939	4812	4203	2688	7421	2859	1448	659	1097	442
Upstream	1 Dif	10-08-1999	11:43:43	0.2 CF	9817	7509	2115	5360	12911	7119	4901	4208	2861	7412	2881	1436	653	1038	455
Upstream	1 Dif	10-08-1999	11:45:49	0.2 CF	10082	7720	2113	5213	13061	7091	4872	4264	2825	7510	2882	1496	624	1074	429
Upstream	1 Dif	10-08-1999	11:47:55	0.2 CF	10334	7810	2183	5493	13208	7142	5009	4328	2850	7860	3002	1453	639	1063	458
Upstream	1 Dif	10-08-1999	11:50:01	0.2 CF	10057	7782	2155	5451	13351	7306	5148	4438	2870	7601	3024	1505	653	1148	425
Upstream	1 Dif	10-08-1999	11:52:07	0.2 CF	10347	7977	2253	5607	13574	7356	5056	4520	2931	7813	3139	1508	653	1103	429
Upstream	1 Dif	10-08-1999	11:54:13	0.2 CF	10337	8001	2231	5491	13240	7129	5027	4474	2896	7732	2954	1494	622	1059	412
Upstream	1 Dif	10-08-1999	11:56:19	0.2 CF	10193	7976	2210	5576	13422	7270	5077	4396	2880	7600	3007	1495	653	1121	443
U. Bckgrnd	1 Dif	10-08-1999	12:04:43	0.2 CF	0	0	0	0	0	0	0	0	0	0	0	0	0	0	0
U. Bckgrnd	1 Dif	10-08-1999	12:06:49	0.2 CF	0	0	0	0	0	0	0	0	0	0	0	0	0	0	0

ENTER DATA BELOW

D. Bckgrnd	2 Dif	10-08-1999	11:32:10	0.2 CF	3	2	0	1	1	1	0	1	0	0	0	0	0	0	0
Downstream	2 Dif	10-08-1999	11:38:28	0.2 CF	2599	1447	318	716	1086	350	133	46	35	53	17	6	2	2	0
Downstream	2 Dif	10-08-1999	11:40:34	0.2 CF	2846	1582	343	701	1189	340	121	62	29	72	18	6	2	4	0
Downstream	2 Dif	10-08-1999	11:42:40	0.2 CF	2768	1443	338	763	1066	311	124	46	33	52	19	7	2	3	1
Downstream	2 Dif	10-08-1999	11:44:46	0.2 CF	2718	1565	360	732	1071	357	118	64	28	42	16	6	4	1	0
Downstream	2 Dif	10-08-1999	11:46:52	0.2 CF	2720	1517	371	758	1081	311	123	47	32	60	12	7	0	2	1
Downstream	2 Dif	10-08-1999	11:48:58	0.2 CF	2814	1547	343	775	1118	343	126	50	31	51	13	5	0	3	0
Downstream	2 Dif	10-08-1999	11:51:04	0.2 CF	2732	1567	350	791	1118	318	117	57	30	54	14	4	1	3	1
Downstream	2 Dif	10-08-1999	11:53:10	0.2 CF	2790	1537	351	741	1167	335	119	53	33	59	14	3	2	1	0
Downstream	2 Dif	10-08-1999	11:55:16	0.2 CF	2787	1608	357	818	1176	337	143	65	36	67	19	4	2	0	0
Downstream	2 Dif	10-08-1999	11:57:22	0.2 CF	2924	1532	362	739	1153	345	152	69	28	62	9	5	2	2	0
D. Bckgrnd	2 Dif	10-08-1999	12:05:46	0.2 CF	8	1	2	3	1	3	0	1	0	0	0	0	0	0	0

Meas. Penetration	0.27	0.20	0.16	0.14	0.09	0.05	0.03	0.01	0.01	0.01	0.01	0.01	0.00	0.00	0.00	0.00
P100 correction values	0.99	0.99	0.97	1.00	0.99	1.00	1.00	1.00	1.01	1.00	1.01	1.01	1.01	1.01	0.99	0.86
Corrected Penetration	0.28	0.20	0.17	0.14	0.09	0.05	0.03	0.01	0.01	0.01	0.01	0.00	0.00	0.00	0.00	
Corrected Efficiency (%)	72	80	83	86	91	95	97	99	99	99	99	100	100	100	100	

Data Acceptance Criteria:

Total Challenge Counts for Each Channel:	100863	77607	21693	54155	131434	71226	49711	43588	28333	76136	29548	14753	6407	10921	4294
Data Quality Objective:	> 500	> 500	> 500	> 500	> 500	> 500	> 500	> 500	> 500	> 500	> 500	> 500	> 500	> 500	> 500
Does this meet DQO:	Yes	Yes	Yes	Yes	Yes	Yes	Yes	Yes	Yes	Yes	Yes	Yes	Yes	Yes	Yes

Standard Deviation of Penetration for Each Channel :	0.01	0.01	0.01	0.01	0.00	0.00	0.00	0.00	0.00	0.00	0.00	0.00	0.00	0.00	0.00
Data Quality Objective:	<0.10	<0.10	<0.10	<0.10	<0.10	<0.10	<0.10	<0.10	<0.10	<0.10	<0.30	<0.30	<0.30	<0.30	<0.30
Does this meet DQO:	Yes	Yes	Yes	Yes	Yes	Yes	Yes	Yes	Yes	Yes	Yes	Yes	Yes	Yes	Yes

Maximum observed particle concentration (#/cc):	13.4
Data Quality Objective: max. allowable conc. (#/cc):	< 14
Does this meet the DQO:	Yes, (applies to all channels)

Test No. 10089906
 No Filter
 Liquid-Phase

Particle Counts per Indicated OPC Channel (1-Minute Samples @ 7.1 L/min)

OPC Channel Number	1	2	3	4	5	6	7	8	9	10	11	12	13	14	15
Min. Diam. (um)	0.28	0.37	0.47	0.52	0.66	0.94	1.22	1.51	1.88	2.07	2.83	3.77	4.71	5.18	6.60
Max. Diam. (um)	0.37	0.47	0.52	0.66	0.94	1.22	1.51	1.88	2.07	2.83	3.77	4.71	5.18	6.60	9.43
Geo. Mean Diam (um)	0.32	0.42	0.49	0.58	0.78	1.07	1.36	1.68	1.97	2.42	3.26	4.21	4.94	5.85	7.89

ENTER DATA BELOW

U. Bckgrnd	1 Dif	10-08-1999	12:17:19	0.2 CF	1	0	0	0	0	0	0	0	0	0	0	0
U. Bckgrnd	1 Dif	10-08-1999	12:19:25	0.2 CF	0	1	0	0	0	0	0	0	0	0	0	0
Upstream	1 Dif	10-08-1999	12:23:37	0.2 CF	9511	7400	2040	5188	12291	6834	4640	4121	2766	7349	2859	1379
Upstream	1 Dif	10-08-1999	12:25:43	0.2 CF	10010	7723	2168	5419	13013	7069	5040	4397	2804	7543	2996	1418
Upstream	1 Dif	10-08-1999	12:27:49	0.2 CF	9953	7548	2040	5336	12999	6905	4839	4117	2673	7410	2785	1406
Upstream	1 Dif	10-08-1999	12:29:55	0.2 CF	9860	7612	2170	5298	13009	7102	4781	4147	2765	7580	2939	1411
Upstream	1 Dif	10-08-1999	12:32:01	0.2 CF	10006	7963	2211	5321	13189	6973	4954	4359	2849	7588	2959	1429
Upstream	1 Dif	10-08-1999	12:34:07	0.2 CF	10025	7801	2149	5377	13073	7073	4941	4481	2844	7753	2966	1450
Upstream	1 Dif	10-08-1999	12:36:13	0.2 CF	10685	8322	2304	5638	13897	7643	5202	4567	2962	8179	3154	1475
Upstream	1 Dif	10-08-1999	12:38:19	0.2 CF	10456	8327	2283	5651	13897	7313	5059	4681	3000	7883	3113	1515
Upstream	1 Dif	10-08-1999	12:40:25	0.2 CF	10394	8190	2284	5799	13857	7459	5199	4463	2999	8043	3073	1534
Upstream	1 Dif	10-08-1999	12:42:31	0.2 CF	10397	8208	2168	5577	13595	7163	5081	4486	2912	7750	3069	1533
U. Bckgrnd	1 Dif	10-08-1999	12:53:43	0.2 CF	0	0	0	0	0	0	0	0	0	0	0	0
U. Bckgrnd	1 Dif	10-08-1999	12:55:49	0.2 CF	0	0	0	0	0	0	0	0	0	0	0	0

ENTER DATA BELOW

D. Bckgrnd	2 Dif	10-08-1999	12:18:22	0.2 CF	2	0	1	0	1	0	0	0	0	0	0	0
Downstream	2 Dif	10-08-1999	12:24:40	0.2 CF	9764	7410	2043	5161	12625	6967	4790	4114	2755	7415	2898	1376
Downstream	2 Dif	10-08-1999	12:26:46	0.2 CF	10124	7707	2152	5514	13296	7128	5101	4383	2918	7735	3067	1443
Downstream	2 Dif	10-08-1999	12:28:52	0.2 CF	10091	7819	2130	5349	12911	6959	4863	4353	2750	7603	2964	1466
Downstream	2 Dif	10-08-1999	12:30:58	0.2 CF	9683	7446	2031	5333	12405	6963	4819	4233	2774	7493	2881	1378
Downstream	2 Dif	10-08-1999	12:33:04	0.2 CF	10025	7814	2181	5383	13176	7008	4964	4311	2850	7794	2987	1455
Downstream	2 Dif	10-08-1999	12:35:10	0.2 CF	10437	8116	2286	5708	13513	7375	5069	4564	2909	7967	3117	1546
Downstream	2 Dif	10-08-1999	12:37:16	0.2 CF	10482	8246	2244	5614	13908	7310	5125	4476	3008	7969	3096	1500
Downstream	2 Dif	10-08-1999	12:39:22	0.2 CF	10412	7863	2178	5451	13583	7291	4978	4423	3020	7852	3060	1526
Downstream	2 Dif	10-08-1999	12:41:28	0.2 CF	10276	7796	2221	5461	13411	7361	5214	4463	2896	7912	3068	1467
Downstream	2 Dif	10-08-1999	12:43:34	0.2 CF	10249	7940	2314	5489	13454	7217	4973	4404	2866	7897	3044	1479
D. Bckgrnd	2 Dif	10-08-1999	12:54:46	0.2 CF	0	0	0	0	0	0	0	0	0	0	0	0

Meas. Penetration	1.00	0.99	1.00	1.00	1.00	1.00	1.00	1.00	1.01	1.01	1.01	1.01	1.01	0.99	0.96	0.81
P100 correction values	1.00	1.00	1.00	1.00	1.00	1.00	1.00	1.00	1.00	1.00	1.00	1.00	1.00	1.00	1.00	1.00
Corrected Penetration	1.00	0.99	1.00	1.00	1.00	1.00	1.00	1.00	1.01	1.01	1.01	1.01	1.01	0.99	0.96	0.81
Corrected Efficiency (%)	0	1	0	0	0	0	0	0	-1	-1	-1	-1	-1	1	4	19

Data Acceptance Criteria:

Total Challenge Counts for Each Channel:	101297	79094	21817	54604	132820	71534	49736	43819	28574	77078	29913	14550	6412	10684	4510
Data Quality Objective:	> 500	> 500	> 500	> 500	> 500	> 500	> 500	> 500	> 500	> 500	> 500	> 500	> 500	> 500	> 500
Does this meet DQO:	Yes	Yes	Yes	Yes	Yes	Yes	Yes	Yes	Yes	Yes	Yes	Yes	Yes	Yes	Yes

Standard Deviation of Penetration for Each Channel :	0.04	0.05	0.06	0.05	0.05	0.04	0.05	0.05	0.05	0.04	0.05	0.05	0.05	0.08	0.05	0.06
Data Quality Objective:	<0.10	<0.10	<0.10	<0.10	<0.10	<0.10	<0.10	<0.10	<0.10	<0.10	<0.10	<0.10	<0.10	<0.30	<0.30	<0.30
Does this meet DQO:	Yes	Yes	Yes	Yes	Yes	Yes	Yes	Yes	Yes	Yes	Yes	Yes	Yes	Yes	Yes	Yes

Maximum observed particle concentration (#/cc):	13.8
Data Quality Objective: max. allowable conc. (#/cc):	< 14
Does this meet the DQO:	Yes, (applies to all channels)

Test No. 10089907

Arrestor

Liquid-Phase

Particle Counts per Indicated OPC Channel (1-Minute Samples @ 7.1 L/min)

OPC Channel Number	1	2	3	4	5	6	7	8	9	10	11	12	13	14	15
Min. Diam. (um)	0.28	0.37	0.47	0.52	0.66	0.94	1.22	1.51	1.88	2.07	2.83	3.77	4.71	5.18	6.60
Max. Diam. (um)	0.37	0.47	0.52	0.66	0.94	1.22	1.51	1.88	2.07	2.83	3.77	4.71	5.18	6.60	9.43
Geo. Mean Diam (um)	0.32	0.42	0.49	0.58	0.78	1.07	1.36	1.68	1.97	2.42	3.26	4.21	4.94	5.85	7.89

ENTER DATA BELOW

U. Bckgrnd	1 Dif	10-08-1999	13:11:03	0.2 CF	2	1	0	0	0	0	0	0	0	0	0	0	0	0	
U. Bckgrnd	1 Dif	10-08-1999	13:13:09	0.2 CF	3	0	0	0	0	0	0	0	0	0	0	0	0	0	
Upstream	1 Dif	10-08-1999	13:17:21	0.2 CF	10028	7737	2111	5300	13044	6911	4917	4353	2779	7537	2900	1500	641	1085	445
Upstream	1 Dif	10-08-1999	13:19:27	0.2 CF	9815	7489	2102	5421	12904	6813	4802	4277	2810	7471	2845	1429	644	999	428
Upstream	1 Dif	10-08-1999	13:21:33	0.2 CF	9520	7357	2064	5139	12453	6879	4665	4057	2656	7144	2838	1420	579	1057	364
Upstream	1 Dif	10-08-1999	13:23:39	0.2 CF	9806	7509	2035	5314	12731	7018	4768	4264	2752	7418	2975	1455	602	1025	451
Upstream	1 Dif	10-08-1999	13:25:45	0.2 CF	10148	7725	2104	5332	12935	7097	4913	4340	2819	7561	3039	1482	646	1097	432
Upstream	1 Dif	10-08-1999	13:27:51	0.2 CF	10192	7860	2246	5498	13149	7339	4906	4301	2796	7623	2997	1441	660	1096	408
Upstream	1 Dif	10-08-1999	13:29:57	0.2 CF	10460	8184	2288	5610	13506	7396	5169	4407	2912	7906	3033	1575	630	1078	450
Upstream	1 Dif	10-08-1999	13:32:03	0.2 CF	10531	8166	2241	5685	13959	7339	5087	4432	3032	7964	3008	1507	647	1147	456
Upstream	1 Dif	10-08-1999	13:34:09	0.2 CF	10351	7913	2272	5527	13415	7179	5102	4399	2893	7655	2975	1538	625	1097	415
Upstream	1 Dif	10-08-1999	13:36:15	0.2 CF	10151	7897	2298	5715	13519	7167	4942	4456	2888	7718	3014	1506	693	1153	452
U. Bckgrnd	1 Dif	10-08-1999	13:55:09	0.2 CF	11	0	0	0	0	0	0	0	0	0	0	0	0	0	0
U. Bckgrnd	1 Dif	10-08-1999	13:57:15	0.2 CF	9	0	0	0	0	0	0	0	0	0	0	0	0	0	0

ENTER DATA BELOW

D. Bckgrnd	2 Dif	10-08-1999	13:12:06	0.2 CF	10	3	0	1	2	1	1	0	0	2	0	0	0	0	0
Downstream	2 Dif	10-08-1999	13:18:24	0.2 CF	2729	1451	361	704	1111	340	118	49	30	51	19	3	1	2	1
Downstream	2 Dif	10-08-1999	13:20:30	0.2 CF	2811	1493	344	768	1201	325	135	73	25	67	13	4	1	1	2
Downstream	2 Dif	10-08-1999	13:22:36	0.2 CF	2669	1483	346	735	1032	318	123	51	24	53	9	1	3	5	1
Downstream	2 Dif	10-08-1999	13:24:42	0.2 CF	2596	1529	355	727	1081	360	144	47	21	49	14	5	0	1	0
Downstream	2 Dif	10-08-1999	13:26:48	0.2 CF	2607	1393	334	737	1153	343	124	48	37	51	13	5	0	0	0
Downstream	2 Dif	10-08-1999	13:28:54	0.2 CF	2748	1527	402	786	1156	344	128	58	35	67	11	1	0	3	0
Downstream	2 Dif	10-08-1999	13:31:00	0.2 CF	2858	1566	373	716	1164	393	149	70	38	61	10	4	3	3	0
Downstream	2 Dif	10-08-1999	13:33:06	0.2 CF	2768	1558	315	760	1119	325	140	59	35	71	15	2	2	0	1
Downstream	2 Dif	10-08-1999	13:35:12	0.2 CF	2807	1562	350	753	1211	335	140	63	37	60	13	5	1	2	1
Downstream	2 Dif	10-08-1999	13:37:18	0.2 CF	2820	1544	365	772	1038	343	128	55	38	64	18	5	0	1	1
D. Bckgrnd	2 Dif	10-08-1999	13:56:12	0.2 CF	13	0	0	0	0	0	0	0	0	0	0	0	0	0	0

Meas. Penetration	0.27	0.19	0.16	0.14	0.09	0.05	0.03	0.01	0.01	0.01	0.01	0.00	0.00	0.00	0.00	0.00	0.00	0.00
P100 correction values	1.00	0.99	1.00	1.00	1.00	1.00	1.00	1.00	1.00	1.01	1.01	1.01	1.01	0.99	0.96	0.81		
Corrected Penetration	0.27	0.20	0.16	0.14	0.09	0.05	0.03	0.01	0.01	0.01	0.01	0.00	0.00	0.00	0.00	0.00		
Corrected Efficiency (%)	73	80	84	86	91	95	97	99	99	99	99	100	100	100	100	100		

Data Acceptance Criteria:

Total Challenge Counts for Each Channel:	101002	77837	21761	54541	131615	71138	49271	43286	28337	75997	29624	14853	6367	10834	4301
Data Quality Objective:	> 500	> 500	> 500	> 500	> 500	> 500	> 500	> 500	> 500	> 500	> 500	> 500	> 500	> 500	> 500
Does this meet DQO:	Yes	Yes	Yes	Yes	Yes	Yes	Yes	Yes	Yes	Yes	Yes	Yes	Yes	Yes	Yes

Standard Deviation of Penetration for Each Channel :	0.01	0.01	0.01	0.01	0.01	0.00	0.00	0.00	0.00	0.00	0.00	0.00	0.00	0.00	0.00
Data Quality Objective:	<0.10	<0.10	<0.10	<0.10	<0.10	<0.10	<0.10	<0.10	<0.10	<0.10	<0.10	<0.30	<0.30	<0.30	<0.30
Does this meet DQO:	Yes	Yes	Yes	Yes	Yes	Yes	Yes	Yes	Yes	Yes	Yes	Yes	Yes	Yes	Yes

Maximum observed particle concentration (#/cc):	13.6
Data Quality Objective: max. allowable conc. (#/cc):	< 14
Does this meet the DQO:	Yes, (applies to all channels)

Test No. 10089908

NO FILTER

Liquid-Phase

Particle Counts per Indicated OPC Channel (1-Minute Samples @ 7.1 L/min)

OPC Channel Number	1	2	3	4	5	6	7	8	9	10	11	12	13	14	15
Min. Diam. (um)	0.28	0.37	0.47	0.52	0.66	0.94	1.22	1.51	1.88	2.07	2.83	3.77	4.71	5.18	6.60
Max. Diam. (um)	0.37	0.47	0.52	0.66	0.94	1.22	1.51	1.88	2.07	2.83	3.77	4.71	5.18	6.60	9.43
Geo. Mean Diam (um)	0.32	0.42	0.49	0.58	0.78	1.07	1.36	1.68	1.97	2.42	3.26	4.21	4.94	5.85	7.89

ENTER DATA BELOW

U. Bckgrnd	1 Dif	10-08-1999	14:35:03	0.2 CF	0	0	0	0	0	0	0	0	0	0	0	0			
U. Bckgrnd	1 Dif	10-08-1999	14:37:09	0.2 CF	3	0	0	0	0	0	0	0	0	0	0	0			
Upstream	1 Dif	10-08-1999	14:45:33	0.2 CF	9959	7626	2123	5291	13049	6929	4440	2724	7620	2923	1500	554	1076	419	
Upstream	1 Dif	10-08-1999	14:47:39	0.2 CF	10258	7939	2158	5559	13339	7095	5072	4511	2855	7480	3092	1499	655	1114	408
Upstream	1 Dif	10-08-1999	14:49:45	0.2 CF	10269	7840	2238	5550	13365	7262	5142	4437	2821	7630	3073	1460	619	1100	447
Upstream	1 Dif	10-08-1999	14:51:51	0.2 CF	10470	8130	2371	5662	13721	7307	5206	4480	2915	7831	3074	1472	648	1135	424
Upstream	1 Dif	10-08-1999	14:53:57	0.2 CF	10359	8033	2308	5608	13631	7319	5153	4430	2984	7746	3070	1552	653	1044	435
Upstream	1 Dif	10-08-1999	14:56:03	0.2 CF	10458	8191	2208	5608	13710	7496	5353	4649	2992	7867	3061	1464	665	1144	469
Upstream	1 Dif	10-08-1999	14:58:09	0.2 CF	10346	8055	2224	5538	13547	7231	5044	4450	2849	7815	2972	1496	615	1095	492
Upstream	1 Dif	10-08-1999	15:00:15	0.2 CF	9719	7789	2084	5501	12866	6874	4753	4208	2682	7453	2894	1443	668	984	413
Upstream	1 Dif	10-08-1999	15:02:21	0.2 CF	9809	7552	2077	5360	12620	7016	4938	4314	2796	7507	2954	1424	646	1084	447
Upstream	1 Dif	10-08-1999	15:04:27	0.2 CF	9576	7275	2050	5008	12390	6581	4724	4162	2826	7201	2952	1377	636	995	405
U. Bckgrnd	1 Dif	10-08-1999	15:12:51	0.2 CF	6	1	0	0	0	0	0	0	0	0	0	0	0	0	0
U. Bckgrnd	1 Dif	10-08-1999	15:14:57	0.2 CF	3	0	0	0	0	0	0	0	0	0	0	0	0	0	0

ENTER DATA BELOW

D. Bckgrnd	2 Dif	10-08-1999	14:36:06	0.2 CF	7	0	0	0	0	0	0	0	0	0	0	0	0	0	
Downstream	2 Dif	10-08-1999	14:46:36	0.2 CF	9882	7828	2206	5373	13071	7069	4929	4365	2889	7640	3042	1493	638	1016	320
Downstream	2 Dif	10-08-1999	14:48:42	0.2 CF	10134	7806	2198	5542	13373	7170	5003	4488	2803	7899	3174	1514	624	1074	339
Downstream	2 Dif	10-08-1999	14:50:48	0.2 CF	10033	7881	2203	5383	13273	7216	4989	4426	2839	7784	3016	1474	611	1018	319
Downstream	2 Dif	10-08-1999	14:52:54	0.2 CF	10364	8096	2207	5543	13357	7333	5124	4452	2885	7906	3104	1465	640	1084	346
Downstream	2 Dif	10-08-1999	14:55:00	0.2 CF	10430	8126	2219	5594	13426	7286	5098	4425	2859	7880	3033	1519	627	944	329
Downstream	2 Dif	10-08-1999	14:57:06	0.2 CF	10211	8106	2112	5539	13455	7163	5108	4422	2966	7798	3079	1473	626	1025	300
Downstream	2 Dif	10-08-1999	14:59:12	0.2 CF	10058	7633	2161	5566	13246	7046	4942	4484	2870	7596	2932	1487	630	1033	352
Downstream	2 Dif	10-08-1999	15:01:18	0.2 CF	10069	7560	2103	5475	12965	7006	5079	4333	2830	7748	2985	1536	599	1008	324
Downstream	2 Dif	10-08-1999	15:03:24	0.2 CF	9759	7499	2017	5200	12602	6918	4859	4177	2716	7507	2920	1340	561	999	325
Downstream	2 Dif	10-08-1999	15:05:30	0.2 CF	9718	7221	2052	5159	12347	6762	4760	4131	2714	7314	2832	1382	553	969	312
D. Bckgrnd	2 Dif	10-08-1999	15:13:54	0.2 CF	4	0	0	0	0	0	0	0	0	0	0	0	0	0	0

Meas. Penetration	0.99	0.99	0.98	0.99	0.99	1.00	0.99	0.99	1.00	1.01	1.00	1.00	1.00	0.96	0.94	0.75
P100 correction values	1.00	1.00	1.00	1.00	1.00	1.00	1.00	1.00	1.00	1.00	1.00	1.00	1.00	1.00	1.00	1.00
Corrected Penetration	0.99	0.99	0.98	0.99	0.99	1.00	0.99	0.99	1.00	1.01	1.00	1.00	1.00	0.96	0.94	0.75
Corrected Efficiency (%)	1	1	2	1	1	0	1	1	0	-1	0	0	4	6	25	

Data Acceptance Criteria:

Total Challenge Counts for Each Channel:	101223	78430	21841	54685	132238	71110	50214	44081	28444	76150	30065	14687	6359	10771	4359
Data Quality Objective:	> 500	> 500	> 500	> 500	> 500	> 500	> 500	> 500	> 500	> 500	> 500	> 500	> 500	> 500	> 500
Does this meet DQO:	Yes	Yes	Yes	Yes	Yes	Yes	Yes	Yes	Yes	Yes	Yes	Yes	Yes	Yes	Yes

Standard Deviation of Penetration for Each Channel :	0.04	0.05	0.06	0.05	0.05	0.04	0.05	0.04	0.04	0.04	0.04	0.04	0.05	0.07	0.06	0.06
Data Quality Objective:	<0.10	<0.10	<0.10	<0.10	<0.10	<0.10	<0.10	<0.10	<0.10	<0.10	<0.10	<0.30	<0.30	<0.30	<0.30	<0.30
Does this meet DQO:	Yes	Yes	Yes	Yes	Yes	Yes	Yes	Yes	Yes	Yes	Yes	Yes	Yes	Yes	Yes	Yes

Maximum observed particle concentration (#/cc):	13.6
Data Quality Objective: max. allowable conc. (#/cc):	< 14
Does this meet the DQO:	Yes, (applies to all channels)

Test No. 10089909

Arrestor
Liquid-Phase

Particle Counts per Indicated OPC Channel (1-Minute Samples @ 7.1 L/min)

OPC Channel Number	1	2	3	4	5	6	7	8	9	10	11	12	13	14	15
Min. Diam. (um)	0.28	0.37	0.47	0.52	0.66	0.94	1.22	1.51	1.88	2.07	2.83	3.77	4.71	5.18	6.60
Max. Diam. (um)	0.37	0.47	0.52	0.66	0.94	1.22	1.51	1.88	2.07	2.83	3.77	4.71	5.18	6.60	9.43
Geo. Mean Diam (um)	0.32	0.42	0.49	0.58	0.78	1.07	1.36	1.68	1.97	2.42	3.26	4.21	4.94	5.85	7.89

ENTER DATA BELOW

U. Bckgrnd	1 Dif 10-08-1999 15:31:45 0.2 CF	5	0	0	0	0	0	0	0	0	0	0	0	0	0	
U. Bckgrnd	1 Dif 10-08-1999 15:33:51 0.2 CF	1	0	0	0	0	0	0	0	0	0	0	0	0	0	
Upstream	1 Dif 10-08-1999 15:40:09 0.2 CF	9645	7420	2092	5187	12352	6768	4642	4080	2742	7211	2723	1339	624	1044	423
Upstream	1 Dif 10-08-1999 15:42:15 0.2 CF	10168	7951	2178	5420	13330	7182	4988	4431	2859	7565	2956	1513	635	1054	511
Upstream	1 Dif 10-08-1999 15:44:21 0.2 CF	10115	7893	2248	5720	13427	7449	4992	4480	2890	7890	3105	1539	718	1105	433
Upstream	1 Dif 10-08-1999 15:46:27 0.2 CF	10496	8003	2224	5540	13525	7391	5023	4430	2878	7718	3046	1475	658	1065	417
Upstream	1 Dif 10-08-1999 15:48:33 0.2 CF	10497	8418	2308	5856	14176	7563	5361	4509	3073	8017	3193	1555	676	1138	456
Upstream	1 Dif 10-08-1999 15:50:39 0.2 CF	10467	8132	2285	5700	13760	7330	5259	4456	2907	7872	3034	1484	642	1130	425
Upstream	1 Dif 10-08-1999 15:52:45 0.2 CF	10092	7707	2224	5613	13273	7107	4902	4402	2922	7563	3003	1470	656	1092	427
Upstream	1 Dif 10-08-1999 15:54:51 0.2 CF	9771	7423	2073	5094	12470	6710	4726	4165	2779	7286	2838	1437	606	1024	432
Upstream	1 Dif 10-08-1999 15:56:57 0.2 CF	9497	7337	2012	5158	12439	6711	4647	4143	2689	7391	2844	1474	620	1031	449
Upstream	1 Dif 10-08-1999 15:59:03 0.2 CF	9481	7227	2085	5144	12457	6760	4716	4105	2709	7257	2854	1332	603	1004	394
U. Bckgrnd	1 Dif 10-08-1999 16:05:21 0.2 CF	1	0	0	0	0	0	0	0	0	0	0	0	0	0	
U. Bckgrnd	1 Dif 10-08-1999 16:07:27 0.2 CF	2	0	0	0	0	0	0	0	0	0	0	0	0	0	

ENTER DATA BELOW

D. Bckgrnd	2 Dif 10-08-1999 15:32:48 0.2 CF	10	5	3	0	5	0	1	1	0	0	0	0	0	0	
Downstream	2 Dif 10-08-1999 15:41:12 0.2 CF	2247	1190	282	518	894	308	142	72	62	155	43	18	13	21	0
Downstream	2 Dif 10-08-1999 15:43:18 0.2 CF	2398	1276	298	622	981	292	160	78	59	178	43	15	7	15	1
Downstream	2 Dif 10-08-1999 15:45:24 0.2 CF	2340	1251	317	612	937	303	140	105	46	137	47	15	5	10	5
Downstream	2 Dif 10-08-1999 15:47:30 0.2 CF	2414	1279	318	617	1005	325	131	89	57	128	53	30	6	13	2
Downstream	2 Dif 10-08-1999 15:49:36 0.2 CF	2336	1317	299	615	997	325	148	74	71	162	62	14	13	12	7
Downstream	2 Dif 10-08-1999 15:51:42 0.2 CF	2278	1307	292	605	943	344	142	85	55	165	52	23	6	9	6
Downstream	2 Dif 10-08-1999 15:53:48 0.2 CF	2325	1268	280	594	1022	285	162	84	50	129	41	22	7	8	5
Downstream	2 Dif 10-08-1999 15:55:54 0.2 CF	2218	1220	279	609	887	289	139	71	51	129	39	22	9	12	5
Downstream	2 Dif 10-08-1999 15:58:00 0.2 CF	2235	1155	264	561	879	278	141	78	47	136	50	16	9	8	6
Downstream	2 Dif 10-08-1999 16:00:06 0.2 CF	2169	1119	263	566	856	304	138	69	61	135	53	17	9	8	3
D. Bckgrnd	2 Dif 10-08-1999 16:06:24 0.2 CF	5	1	0	4	1	0	3	0	0	1	0	1	0	0	

Meas. Penetration	0.23	0.16	0.13	0.11	0.07	0.04	0.03	0.02	0.02	0.02	0.02	0.01	0.01	0.01	0.01
P100 correction values	0.99	0.99	0.98	0.99	0.99	1.00	0.99	0.99	1.00	1.01	1.00	1.00	0.96	0.94	0.75
Corrected Penetration	0.23	0.16	0.13	0.11	0.07	0.04	0.03	0.02	0.02	0.02	0.02	0.01	0.01	0.01	0.01
Corrected Efficiency (%)	77	84	87	89	93	96	97	98	98	98	98	99	99	99	99

Data Acceptance Criteria:

Total Challenge Counts for Each Channel:	100229	77511	21729	54432	131209	70971	49256	43201	28448	75770	29596	14618	6438	10687	4367
Data Quality Objective:	> 500	> 500	> 500	> 500	> 500	> 500	> 500	> 500	> 500	> 500	> 500	> 500	> 500	> 500	> 500
Does this meet DQO:	Yes	Yes	Yes	Yes	Yes	Yes	Yes	Yes	Yes	Yes	Yes	Yes	Yes	Yes	Yes

Standard Deviation of Penetration for Each Channel :	0.01	0.01	0.01	0.01	0.01	0.00	0.00	0.00	0.00	0.00	0.00	0.00	0.00	0.00	0.01
Data Quality Objective:	<0.10	<0.10	<0.10	<0.10	<0.10	<0.10	<0.10	<0.10	<0.10	<0.10	<0.30	<0.30	<0.30	<0.30	<0.30
Does this meet DQO:	Yes	Yes	Yes	Yes	Yes	Yes	Yes	Yes	Yes	Yes	Yes	Yes	Yes	Yes	Yes

Maximum observed particle concentration (#/cc):	13.9
Data Quality Objective: max. allowable conc. (#/cc):	< 14
Does this meet the DQO:	Yes, (applies to all channels)