

US EPA ARCHIVE DOCUMENT

Understanding Thermal/Optical Analysis

Judith C. Chow (judy.chow@dri.edu)

John G. Watson

L.-W. Antony Chen

Desert Research Institute, Reno, NV

Presented at:

The Atmospheric Science Progress Review
Meeting

Research Triangle Park, NC

June 21, 2007

Objectives

- Reconcile different thermal/optical methods by determining factors that influence OC/EC split
- Specify differences in optical properties between particles in the air, particles on a filter, and particles undergoing changes owing to thermal analysis
- Quantify differences in thermal carbon fractions determined by commonly used thermal/optical methods
- Optimize thermal/optical methods to meet multiple needs of health, visibility, global, and source apportionment

Large Temperature and Analysis Time Variations in OC for Thermal/Optical Methods

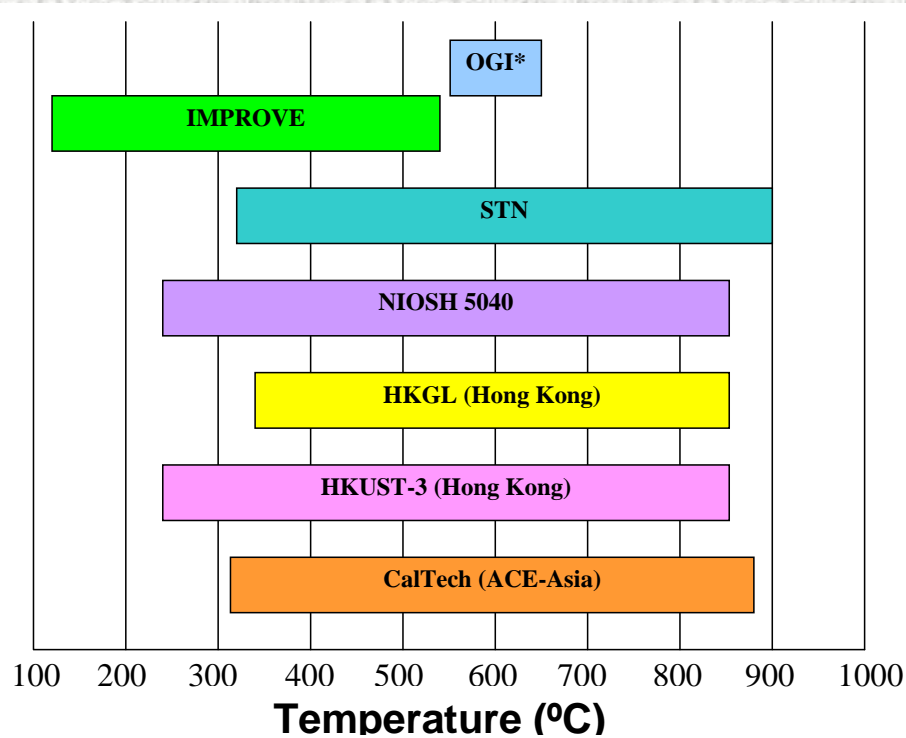

(~120 to 900 °C)

*OGI OC performed at 600 °C only

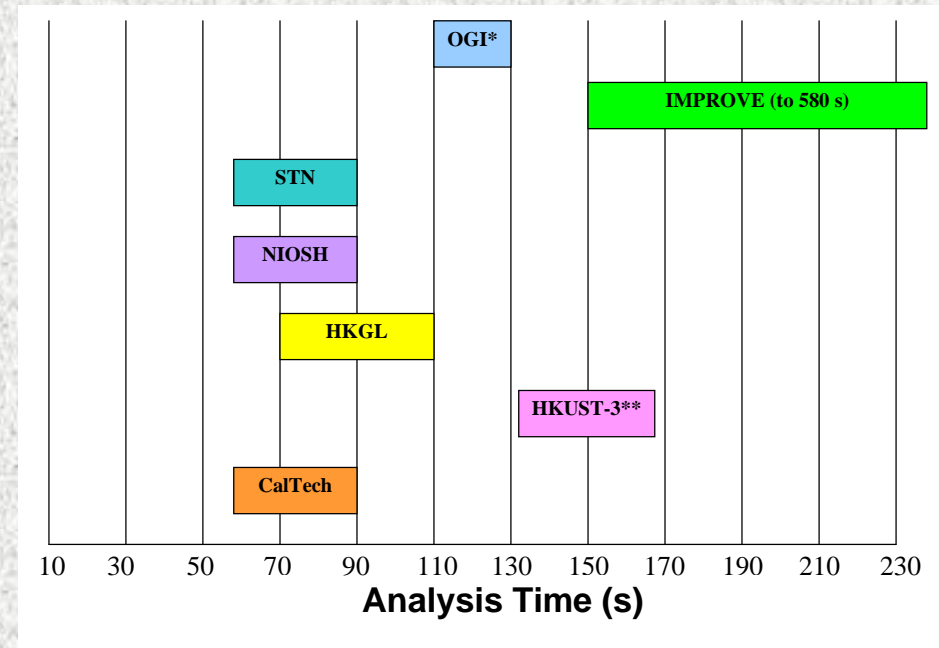

(~30 to 580 sec)

*OGI Time is variable

**HKUST-3 Time 150 s only

Large Temperature and Analysis Time Variations in EC for Thermal/Optical Methods

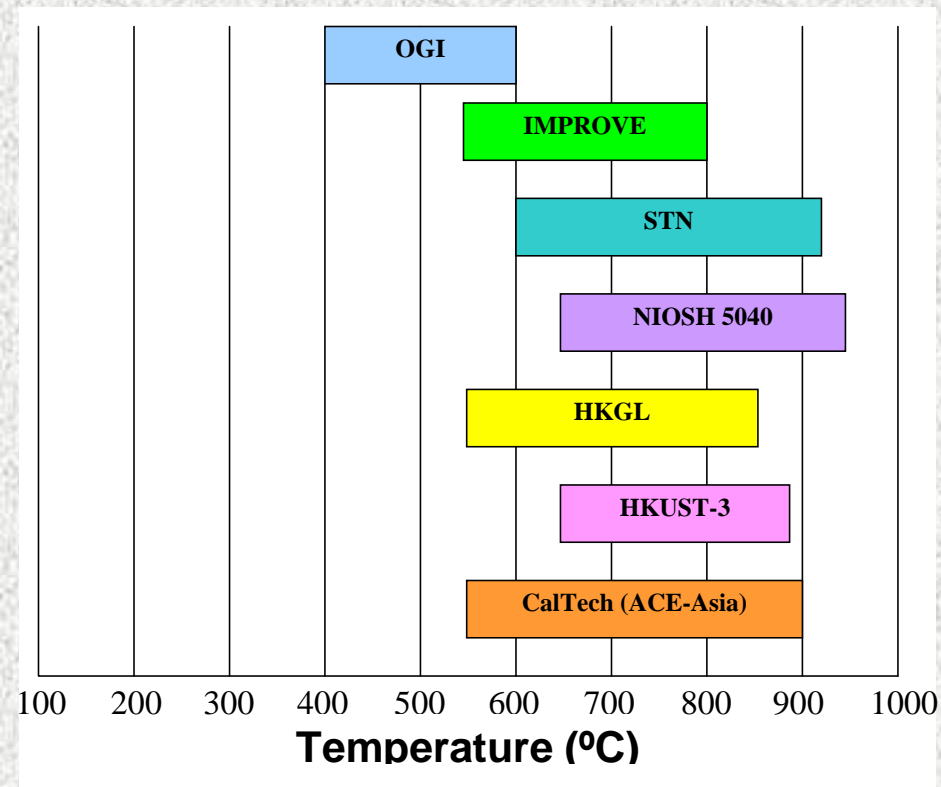

(400 to 920 °C)

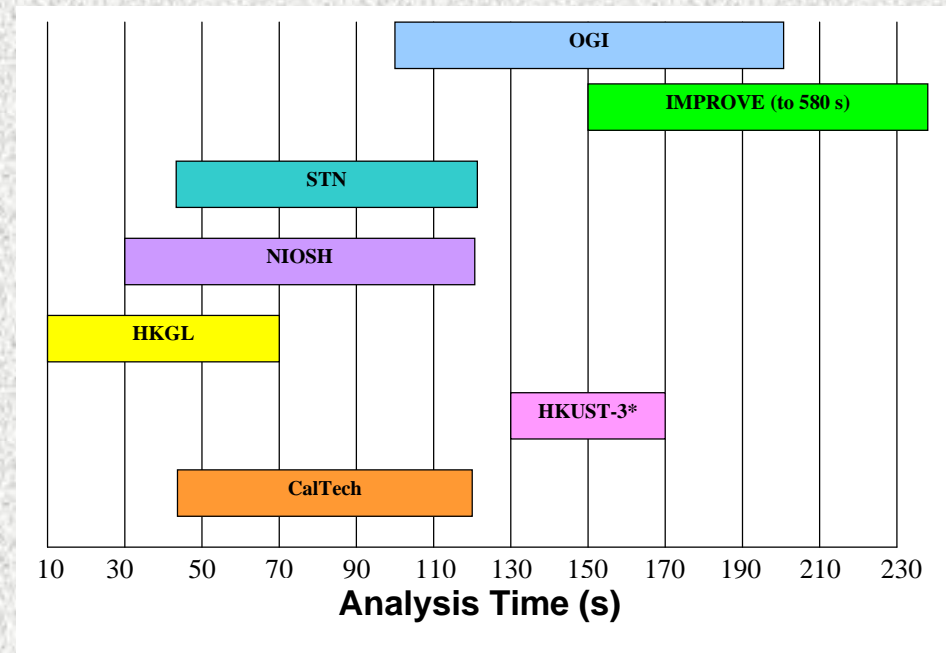

(60 to 580 sec)

*HKUST-3 Time 150 s only

Watson et al. (2005)

IMPROVE vs. IMPROVE_A*

Thermal Protocols

Original OGC/DRI
Thermal Optical
Analyzer (1986)

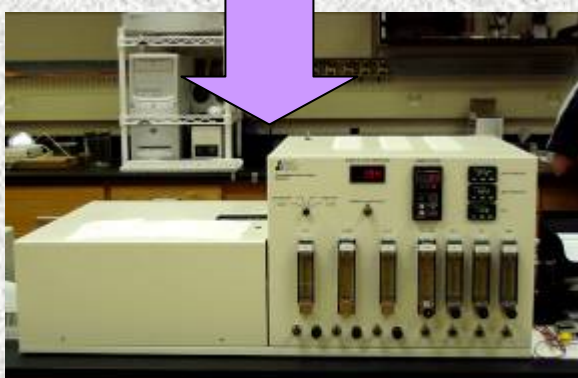
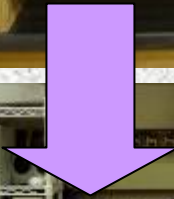

DRI Model 2001
Thermal/Optical Analyzer

	IMPROVE_A* (DRI Model 2001)	IMPROVE (DRI/OGC)
OC1	140 °C	120 °C
OC2	280 °C	250 °C
OC3	480 °C	450 °C
OC4	580 °C	550 °C
OP (POC)	TOR/TOT	TOR
EC1	580 °C	550 °C
EC2	740 °C	700 °C
EC3	840 °C	800 °C

*After temperature and O₂ calibration.
Implemented for samples acquired after
January 1, 2005

No difference in OC/EC split between IMPROVE by DRI/OGC and IMPROVE_A by Model 2001

OC_TOR (Sample Date 3/1/2004 - 9/30/2006)

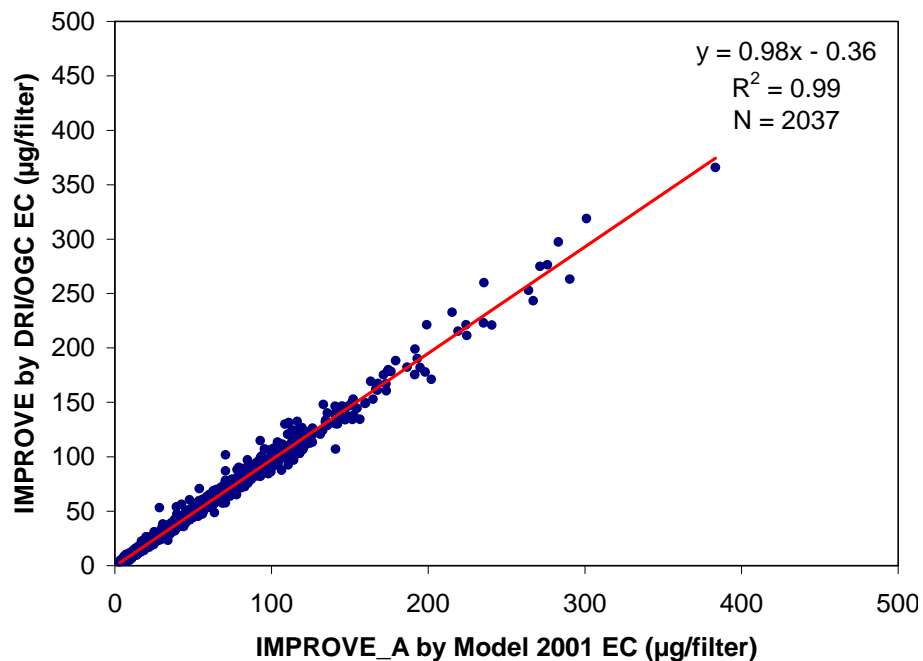

EC_TOR (Sample Date 3/1/2004 - 9/30/2006)

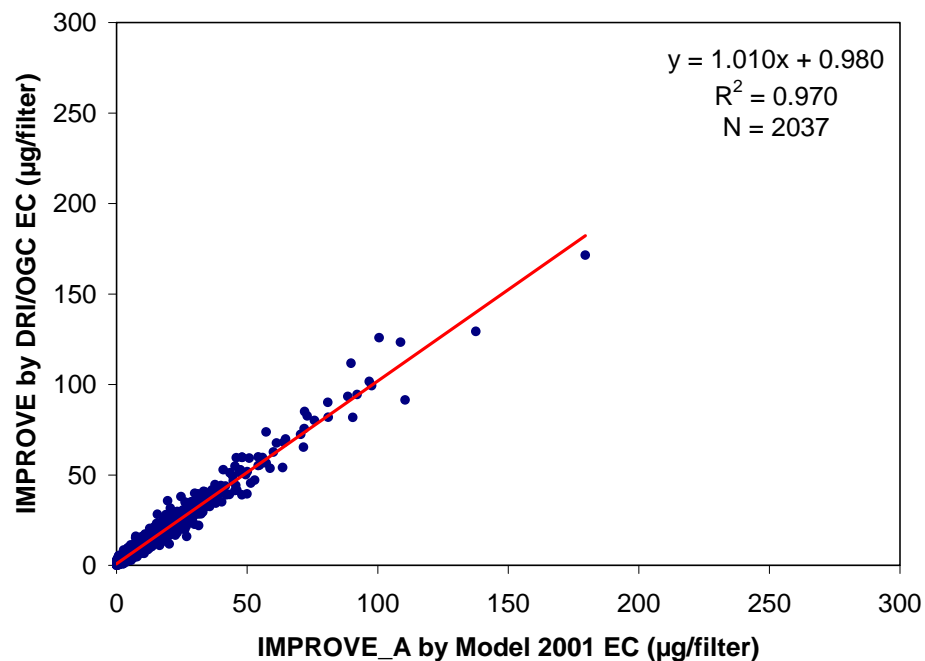

Effect on Carbon Fractions by Temperature and O₂ Level

- Low temperature OC1 (140 °C) and OC2 (280 °C) are sensitive to temperature independent of the oxidant level
- As O₂ > 100 ppmv in He atmosphere, changes in OC3 (480 °C), OP, and EC1 (580 °C) are found

Laboratory Generated Carbon Sources



Diesel Generator

4 kW load
Dilution ratios (DR)
of 18, 40, 80 and
150

sample time (T) of
20 or 60 min

Source, Source +
NaCl



Wood Stove

White Oak
DR of 18, 40, 105

T of 20 or 25 min

Source, Source +
NaCl



2-inch flame
DR of 17

T of 20, 40, 70 min

Source, Source +
NaCl



Acetylene Flame



- Electric Arc Generator (PALAS) DR of 8; T = 20 or 40 min; Source, Source + NaCl



- Carbon Black and Graphite Powder

Source Characterization Systems for Reference Samples

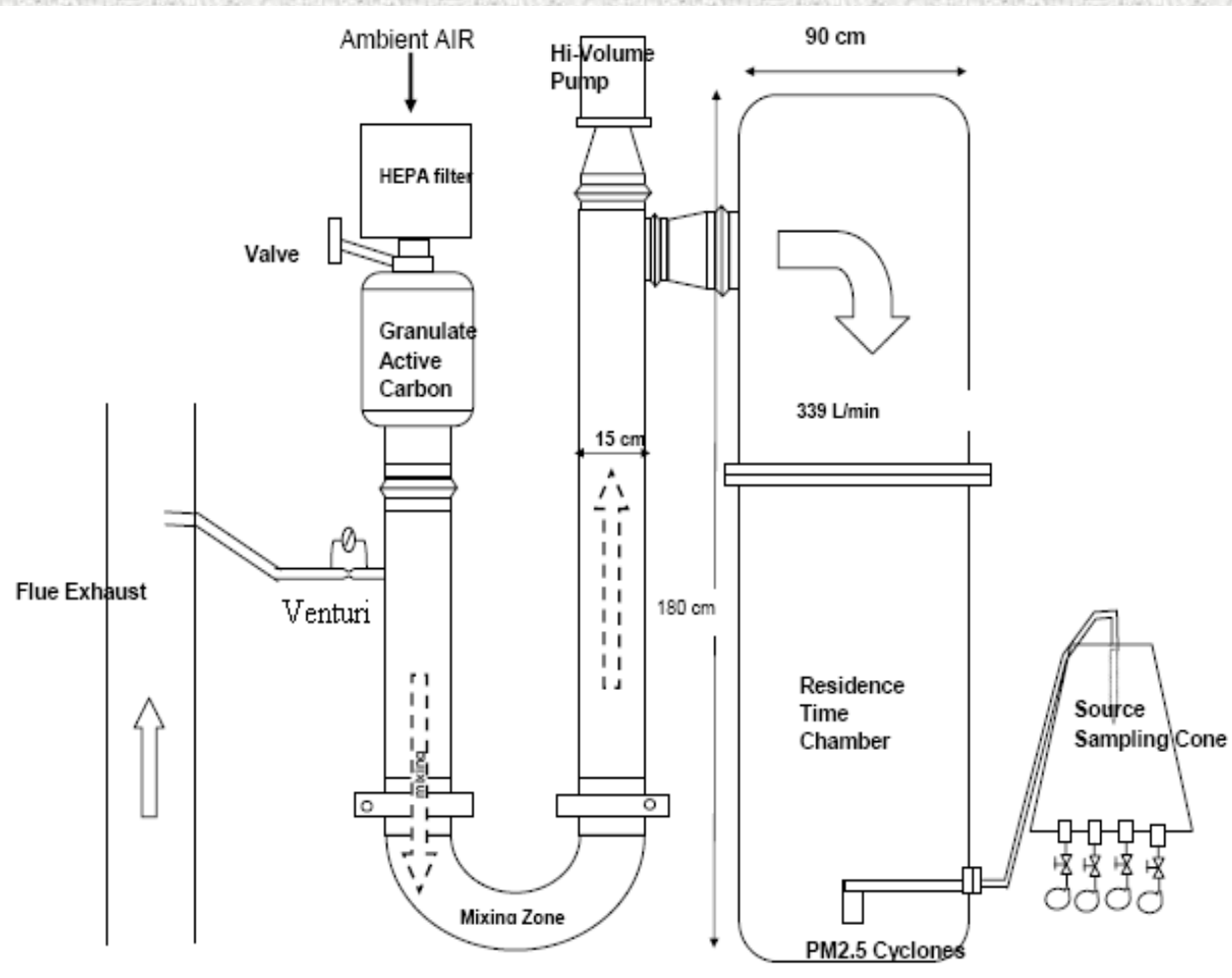

Dilution Sampling System

For Diesel Exhaust
Acetylene Soot
Wood Smoke

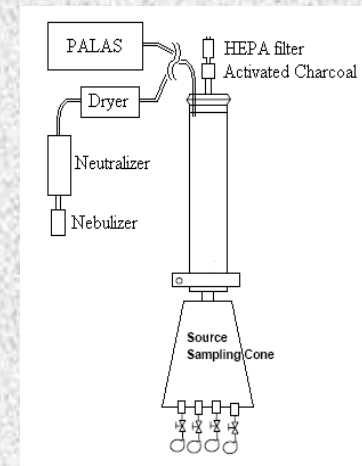

Miniature Dilution System

For Electric Arc Generator

Re-suspension Chamber

For Carbon Black

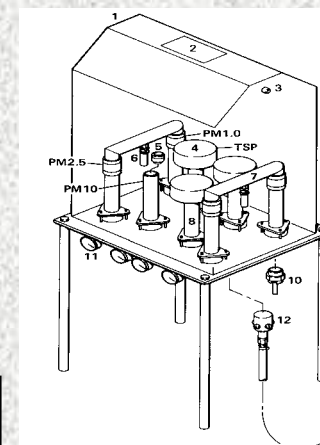

Source Testing Instrumentation

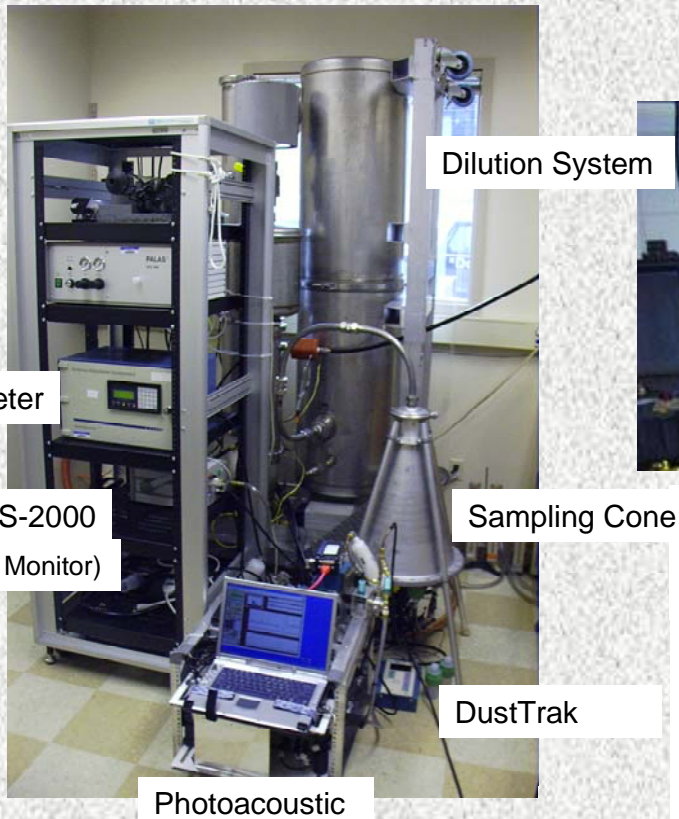

Particle Sizing Instruments (3 nm to 10 μm)

- TSI Nano-SMPS (TSI, St. Paul, MN)
- Grimm SMPS + C (Grimm, Ainring, Germany)
- MSP Wide Range Spectrometer (MSP; St. Paul, MN)

Most laboratory generated sources can reproduce TC (Relative Standard Deviation*, RSD < 15% typically, except for Wood Smoke)

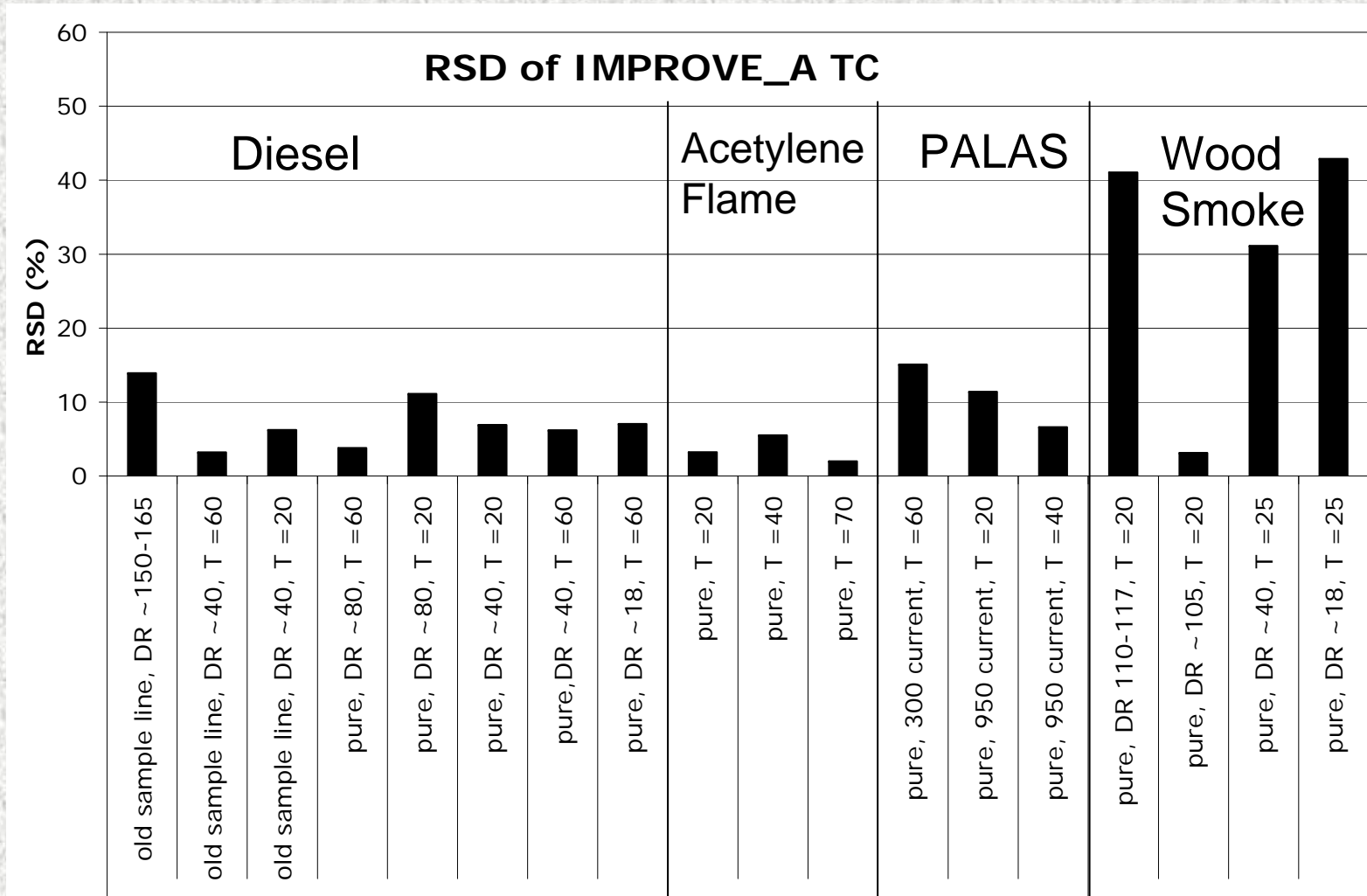

*standard deviation divided by the arithmetic mean, expressed in percentage

IMPROVE, STN and French Protocols

IMPROVE_A_TOR/TOT				STN_TOT			French 2-step		
	Gas	Temp (°C)	Time (sec)	Gas	Temp (°C)	Time (sec)	Gas	Temp (°C)	Time (sec)
OC1	He	140	150 to 580	He	310	60	O ₂	340	7200
OC2	He	280	150 to 580	He	480	60			
OC3	He	480	150 to 580	He	615	60			
OC4	He	580	150 to 580	He	900	90			
	He	n/a	n/a	He	cool oven	-			
EC1	O ₂ /He	580	150 to 580	O ₂ /He	600	45	O ₂	1100	~600
EC2	O ₂ /He	780	150 to 580	O ₂ /He	675	45			
EC3	O ₂ /He	840	150 to 580	O ₂ /He	750	45			
EC4	O ₂ /He	n/a	n/a	O ₂ /He	825	45			
EC5	O ₂ /He	n/a	n/a	O ₂ /He	920	120			
Detection	Methanator / FID			Methanator / FID			Coulometric titration of CO ₂ for EC phase. TC from another punch. OC by difference.		
Pyrolysis Correction	Reflectance & Transmittance			Transmittance			None		

Source-to-source variations in EC are apparent (EC is similar between protocols, except for wood smoke)

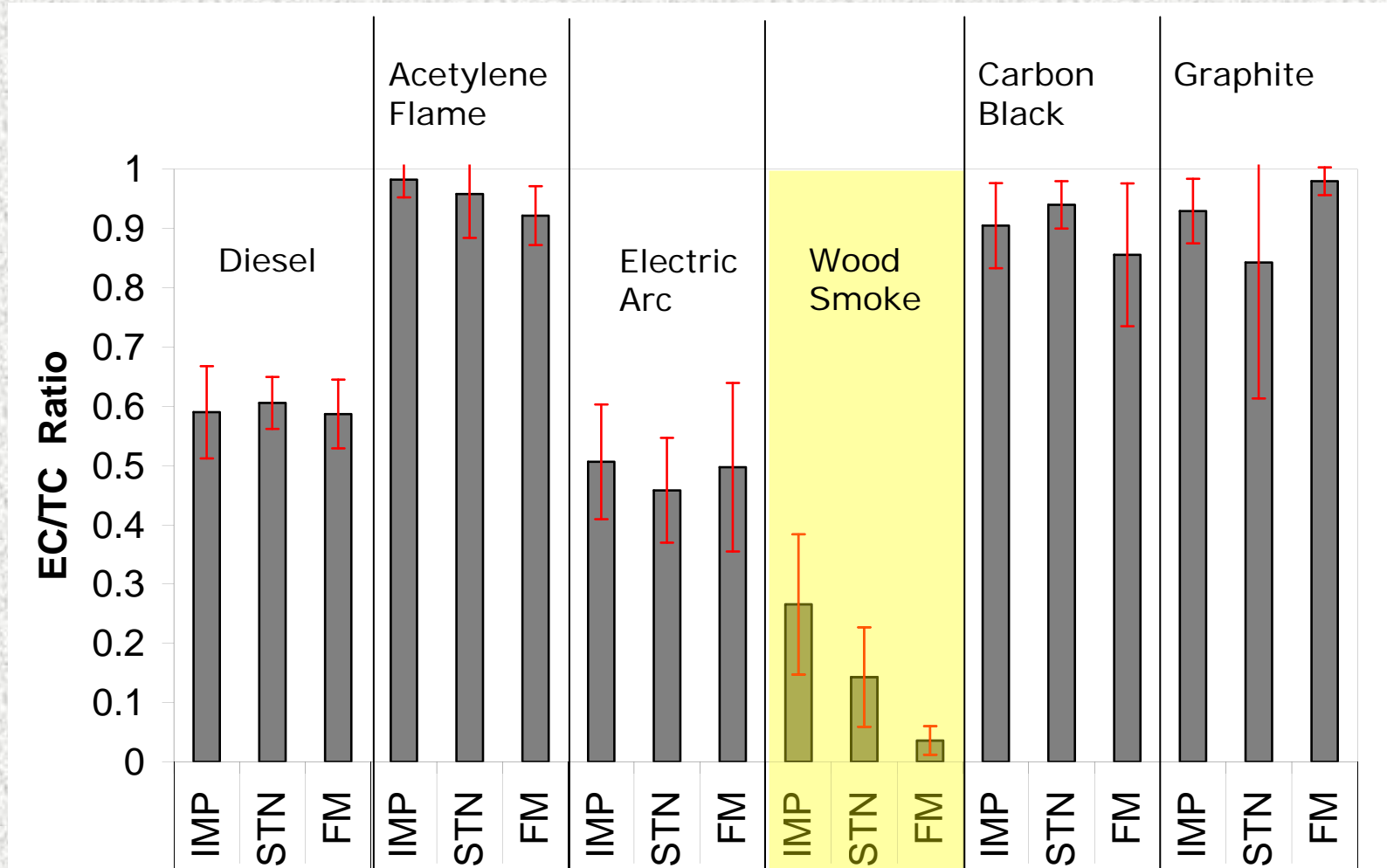

Carbon fractions vary by source

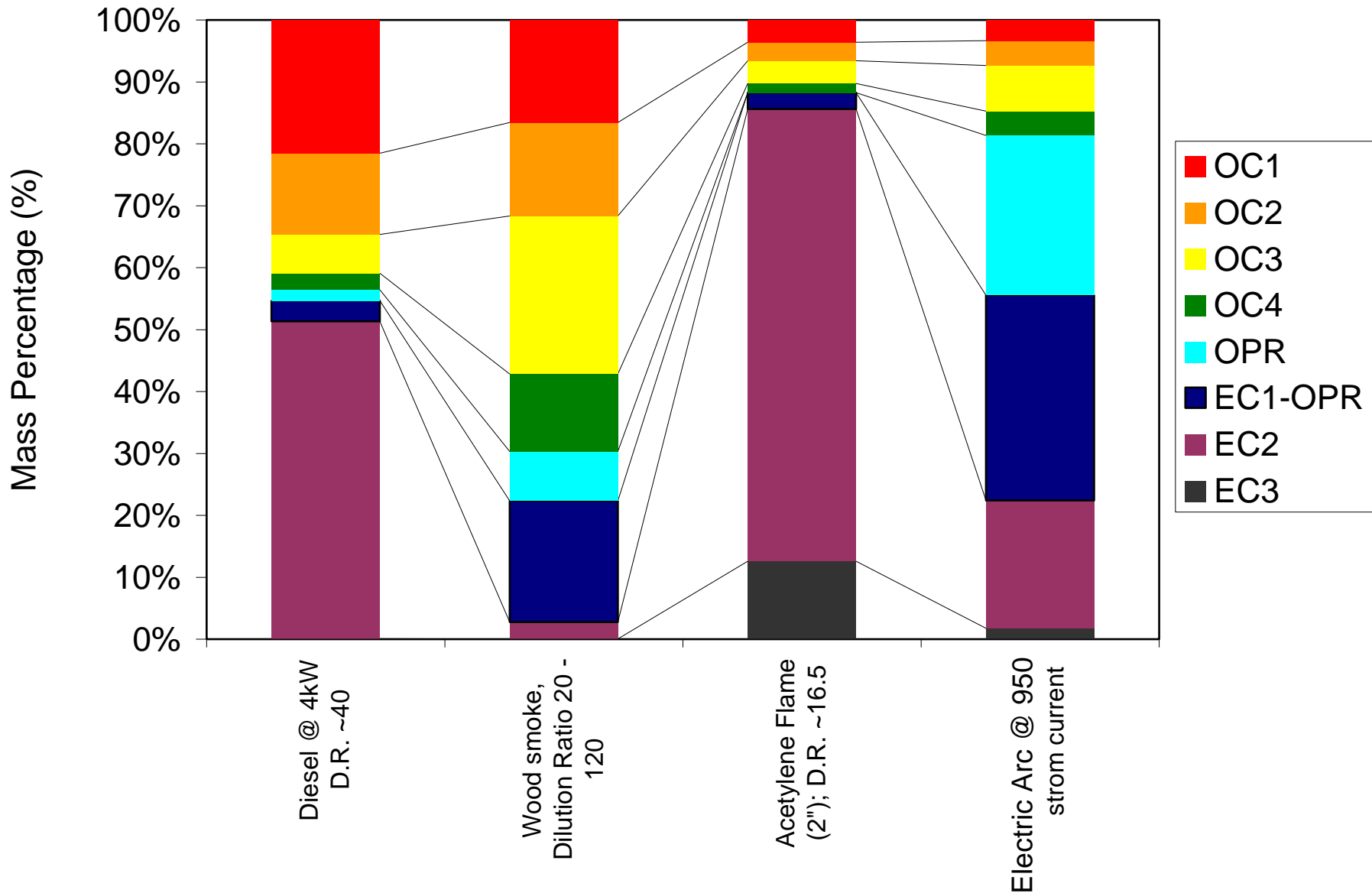

Presence of NaCl shifts EC to lower temperature fractions*

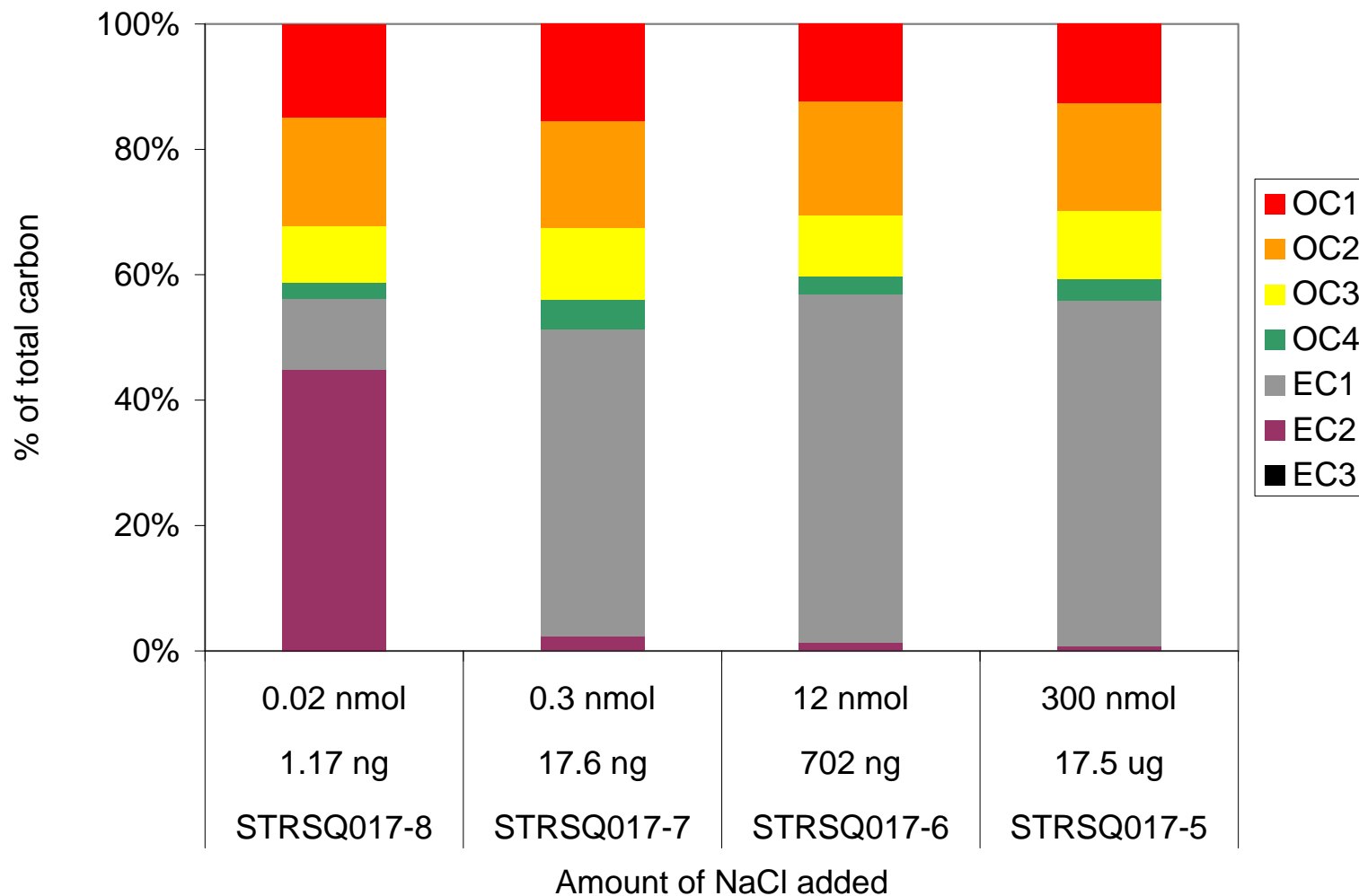

* Higher NaCl -> greater shift from EC2 to EC1

NaCl has the largest effect among halogen salts on EC fractions

- For NaCl, shift of EC2 to EC1.
- For NaBr, no shift at 0.3 nmol but shift at 0.75 nmol
- For NaI, no shift for both 0.3 and 0.75 nmol

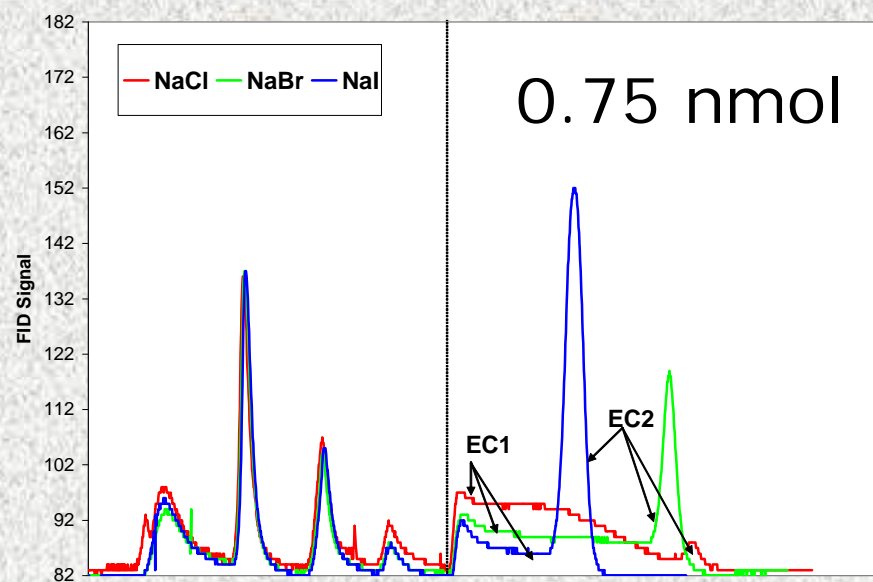
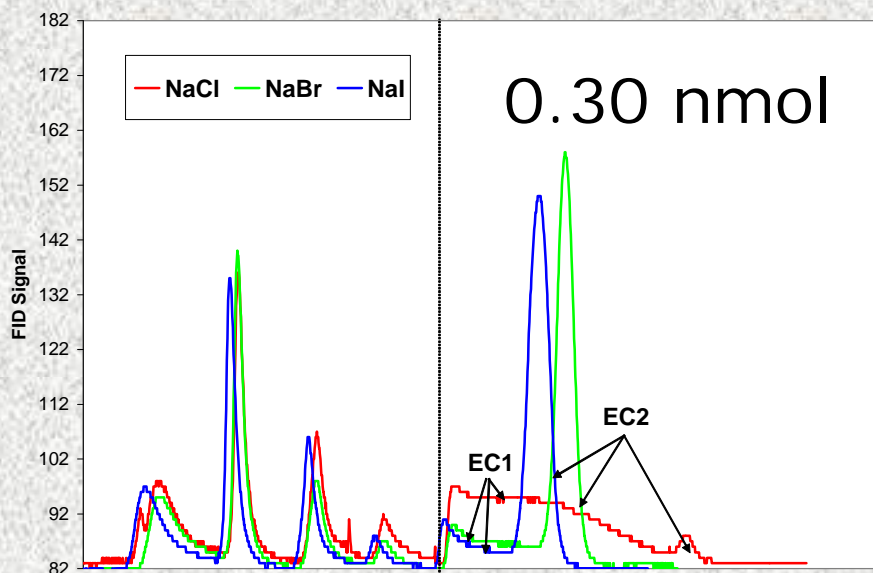

Catalytic reactivity: NaCl > NaBr > NaI

Addition of NaCl shifts EC to lower temperature fractions

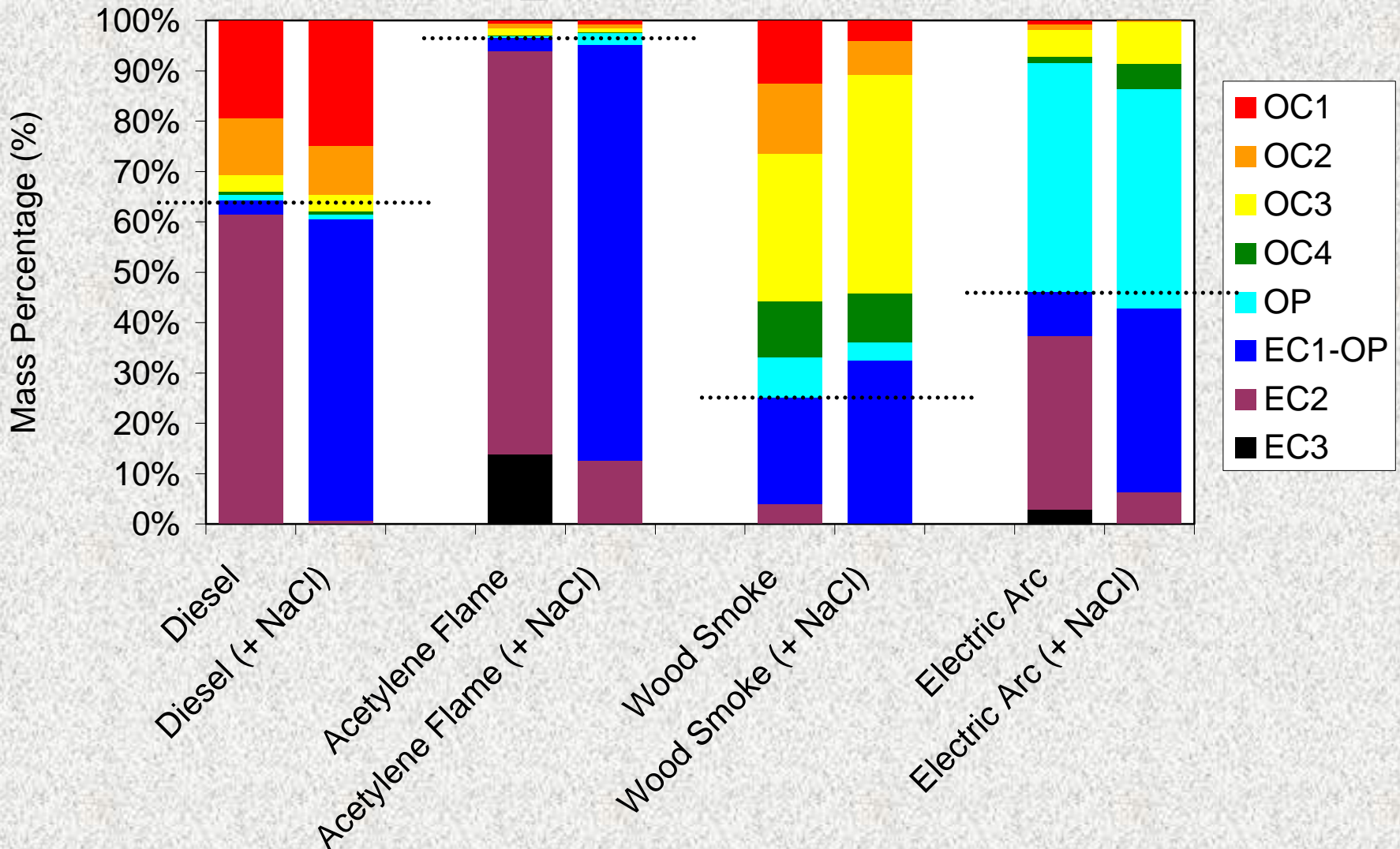

IMPROVE_A protocol (front filter)

Carbon fractions in biomass burning varied by fuel and combustion conditions

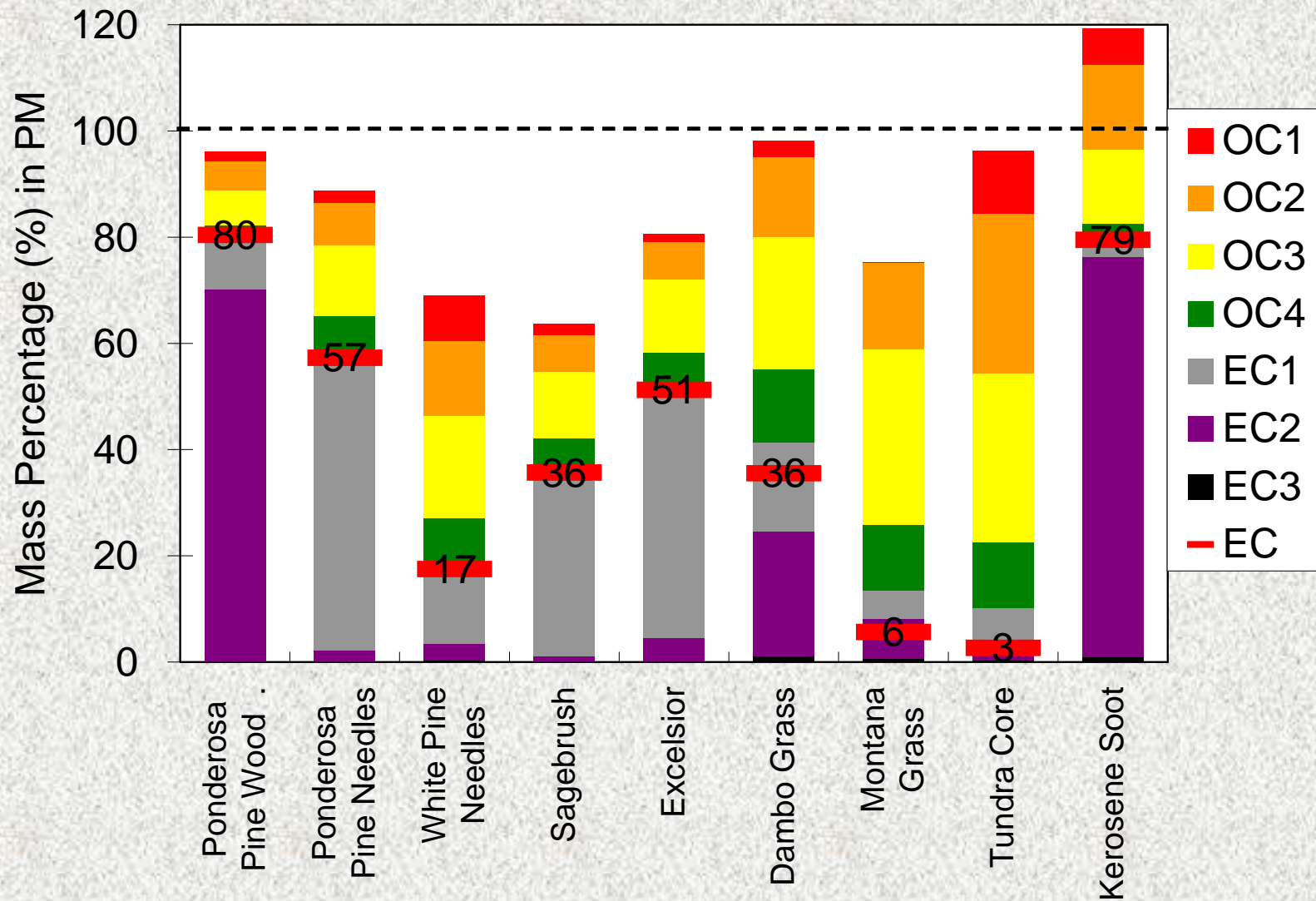

Higher NH_4Cl results in lower EC2

- Higher NH_4Cl shifts more EC2 to EC1
- Effects at micro-mole/micro-gram level
- No effect on OC speciation

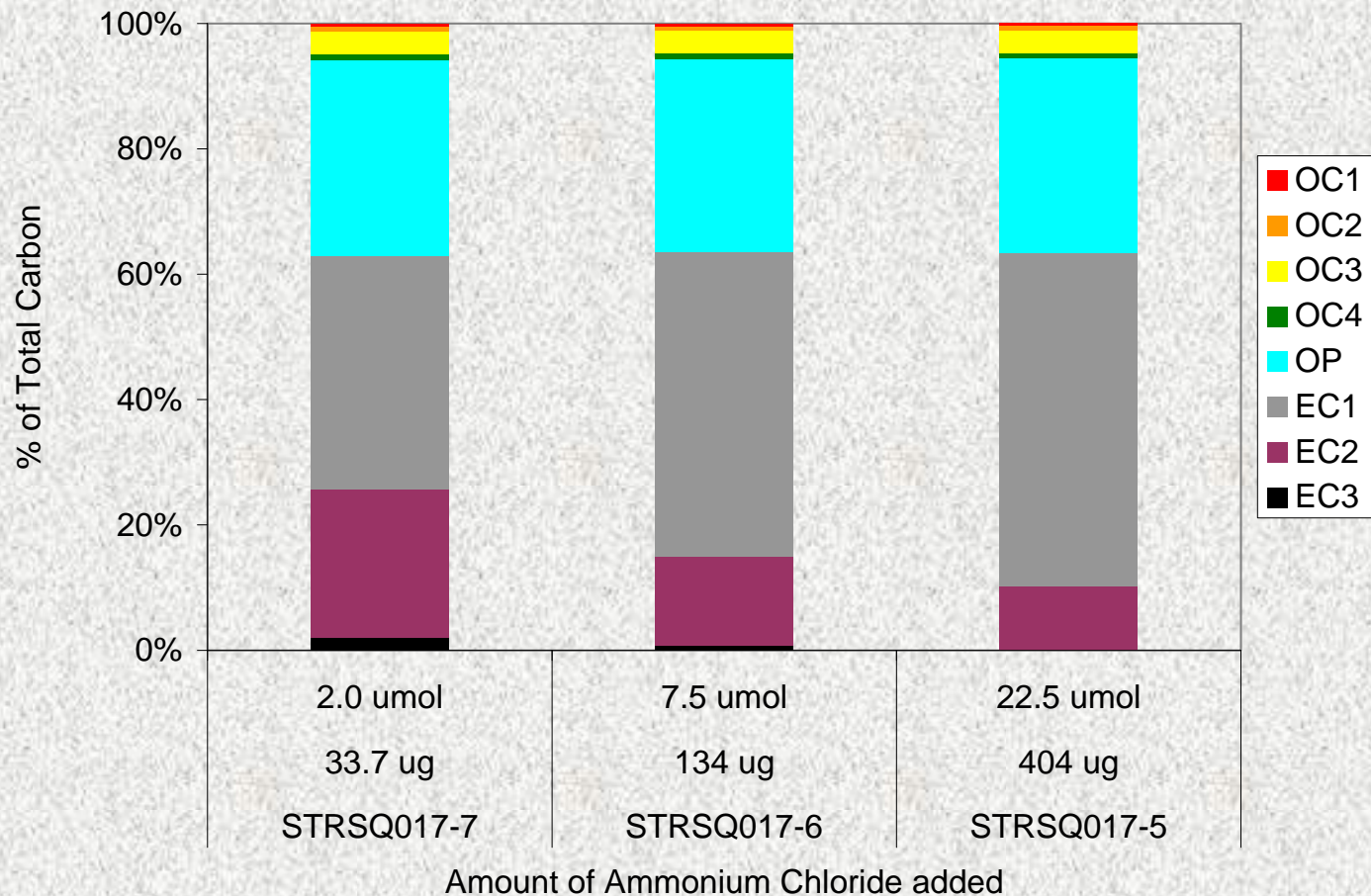

Presence of $(\text{NH}_4)_2\text{SO}_4$ minimizes pyrolysis

- Melting point = 280°C
- Suppression of pyrolyzed carbon formed
- No EC shift was observed

Original Filter

Spiked with $3.0\ \mu\text{mol}$ of ammonium sulfate

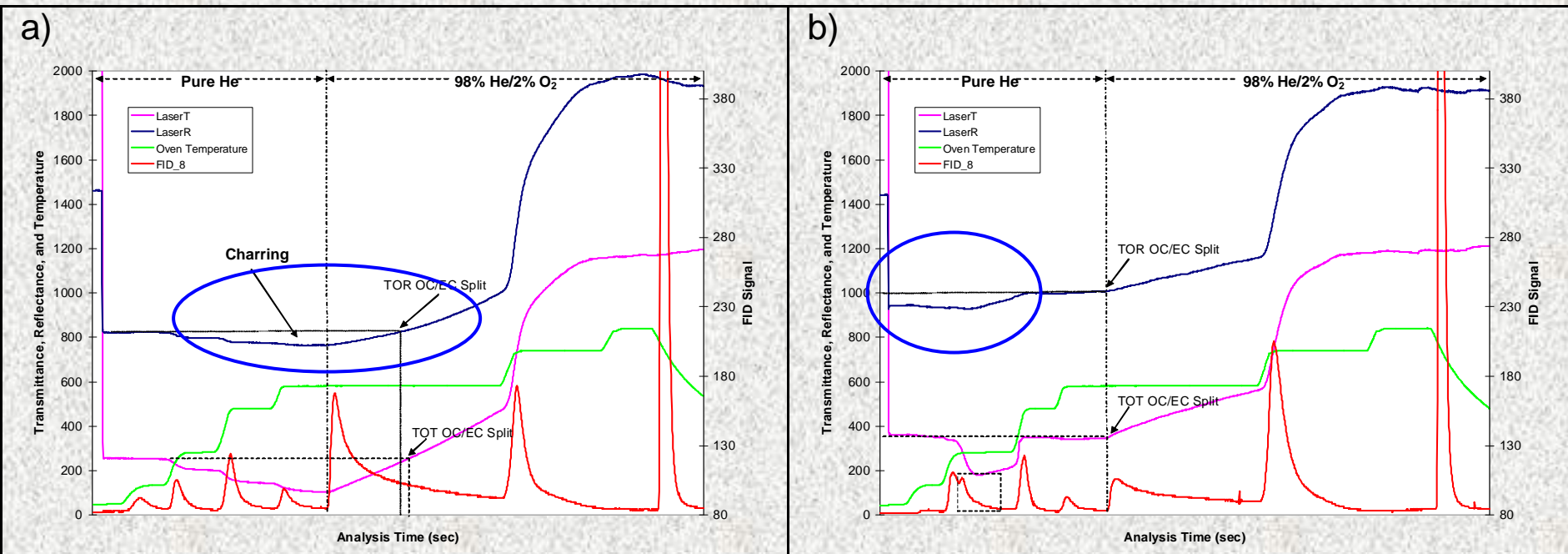

Na₂SO₄ does not suppress pyrolysis

- Melting point = 884 °C.
- Shift of EC 2 to EC1 but no suppression of charring.

Original Filter

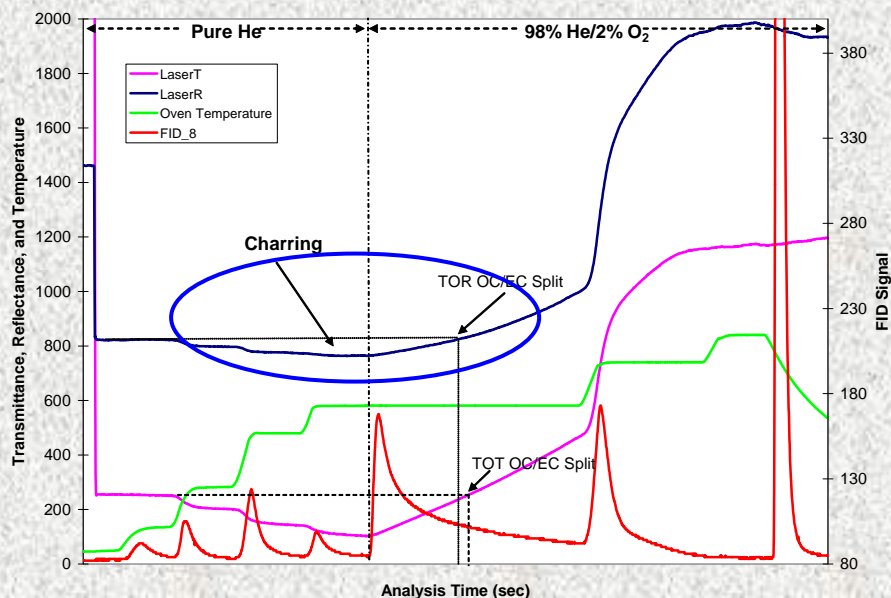

Spiked with 3.0 μmol of sodium sulfate

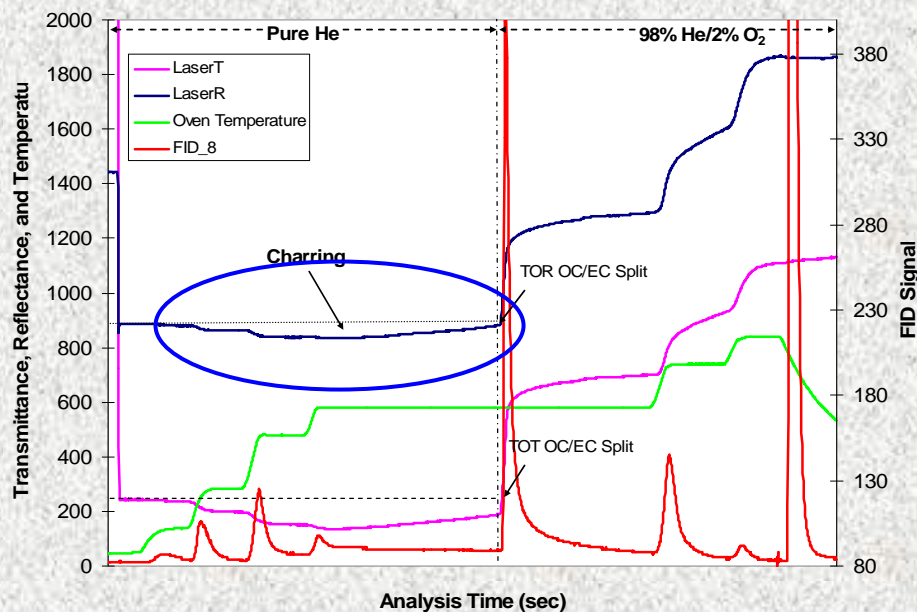

Optical Modeling of Filter Reflectance and Transmittance

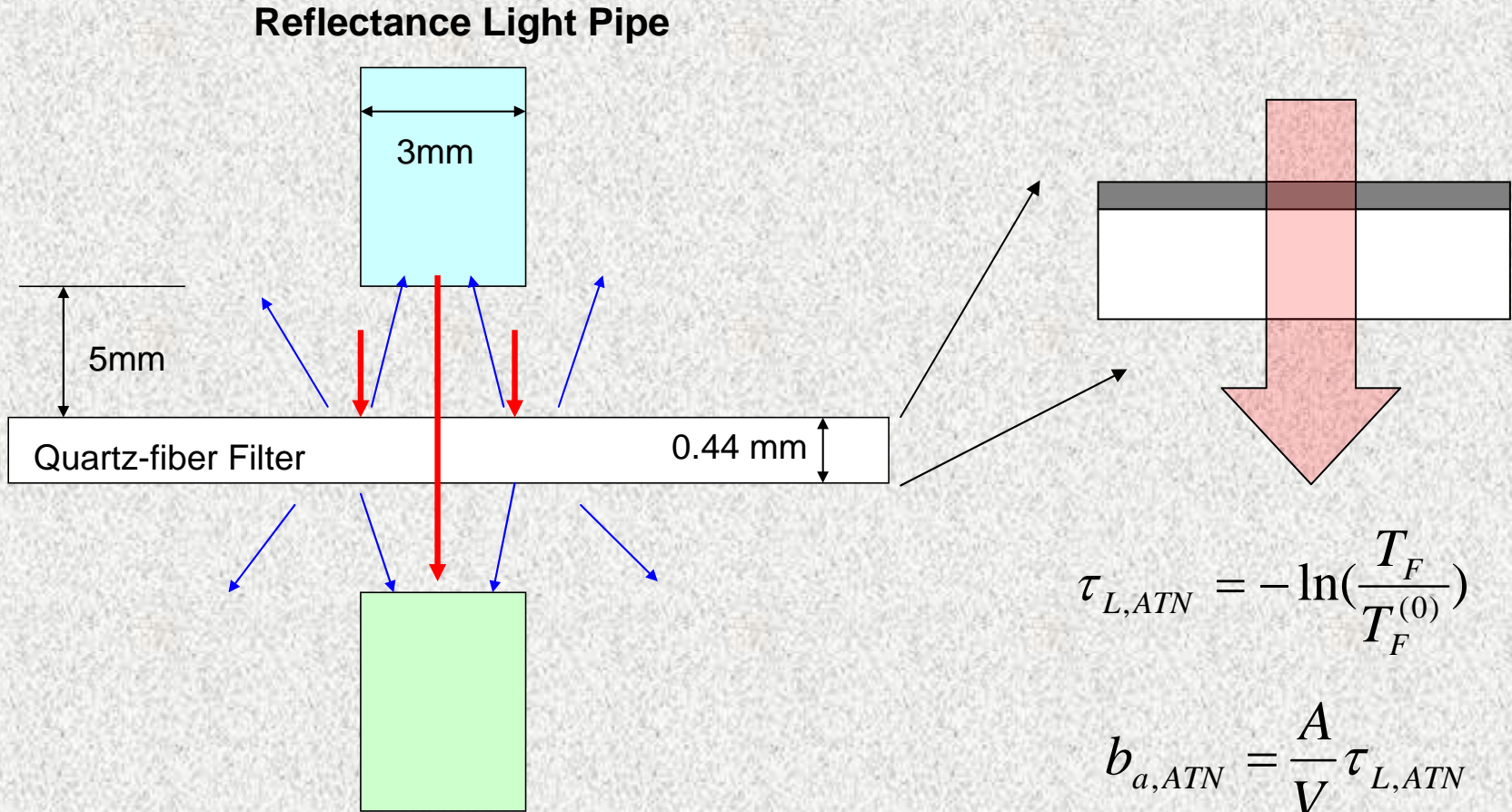

$$\tau_{L,ATN} = -\ln\left(\frac{T_F}{T_F^{(0)}}\right)$$

$$b_{a,ATN} = \frac{A}{V} \tau_{L,ATN}$$

- Multiple scattering?
- Effect of loading?

A=Filter Surface Area
V=Sample Volume

(Apparent) Absorption Efficiency Varies between EC and OP

$$[Carbon]_{after_O_2} = [EC] + [OP] = \frac{\tau_{ATN,EC}}{E_{a,EC}} + \frac{\tau_{ATN,OP}}{E_{a,OP}}$$

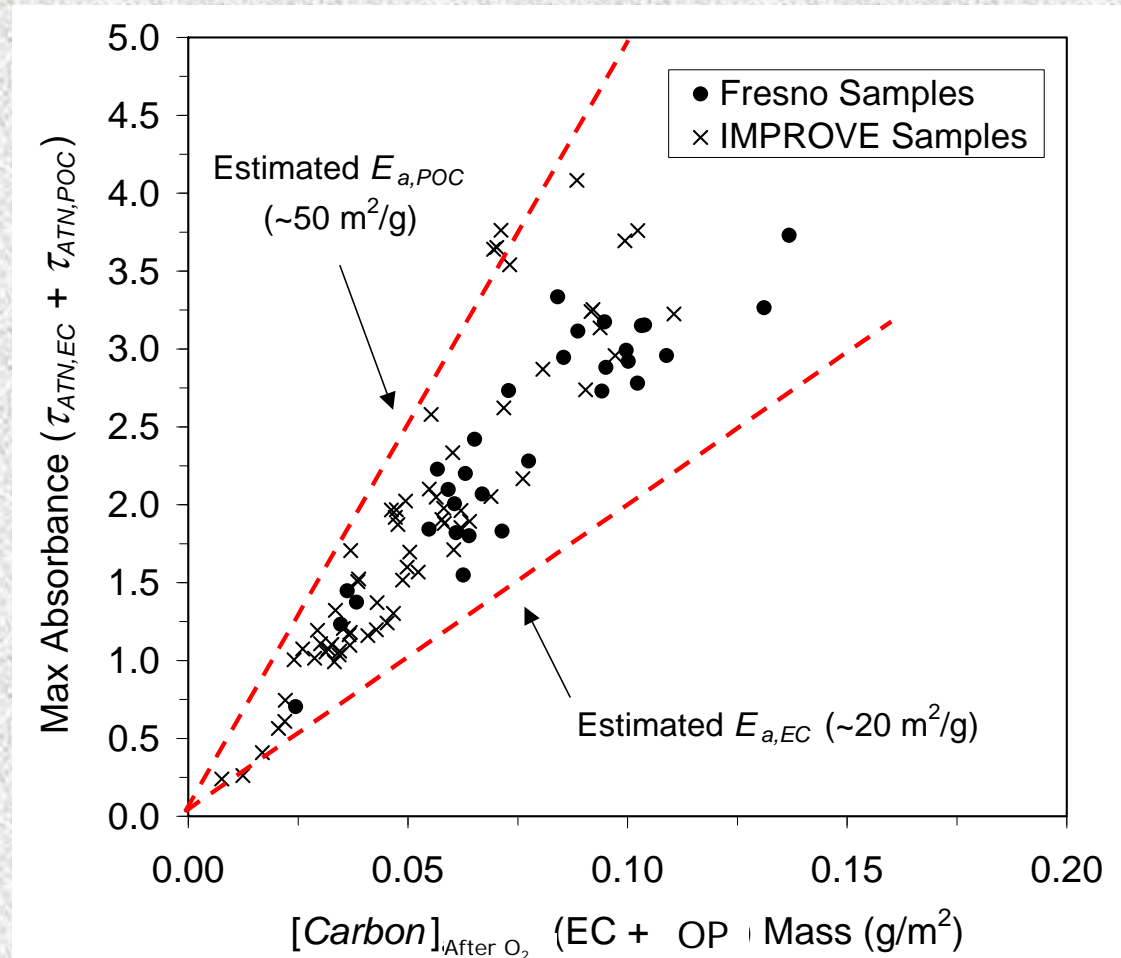

Monte Carlo Model Estimation of Reflectance (R) and Transmittance (T)

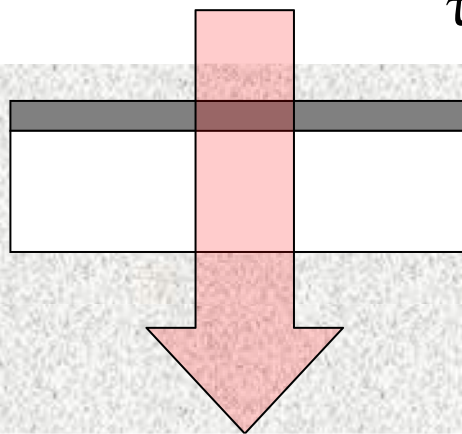
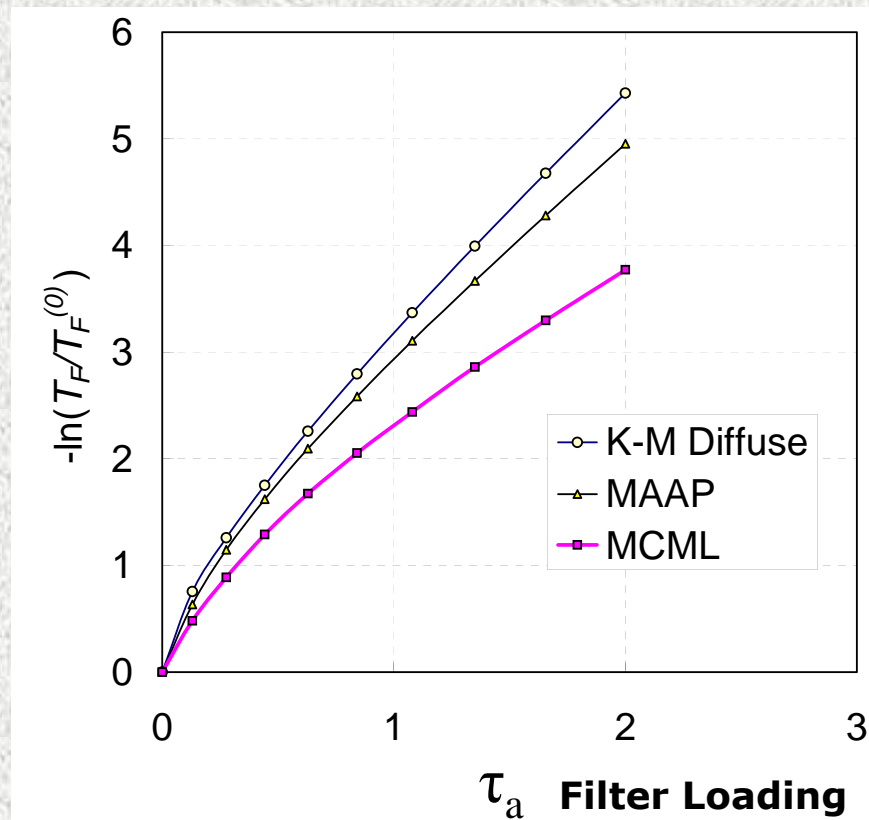
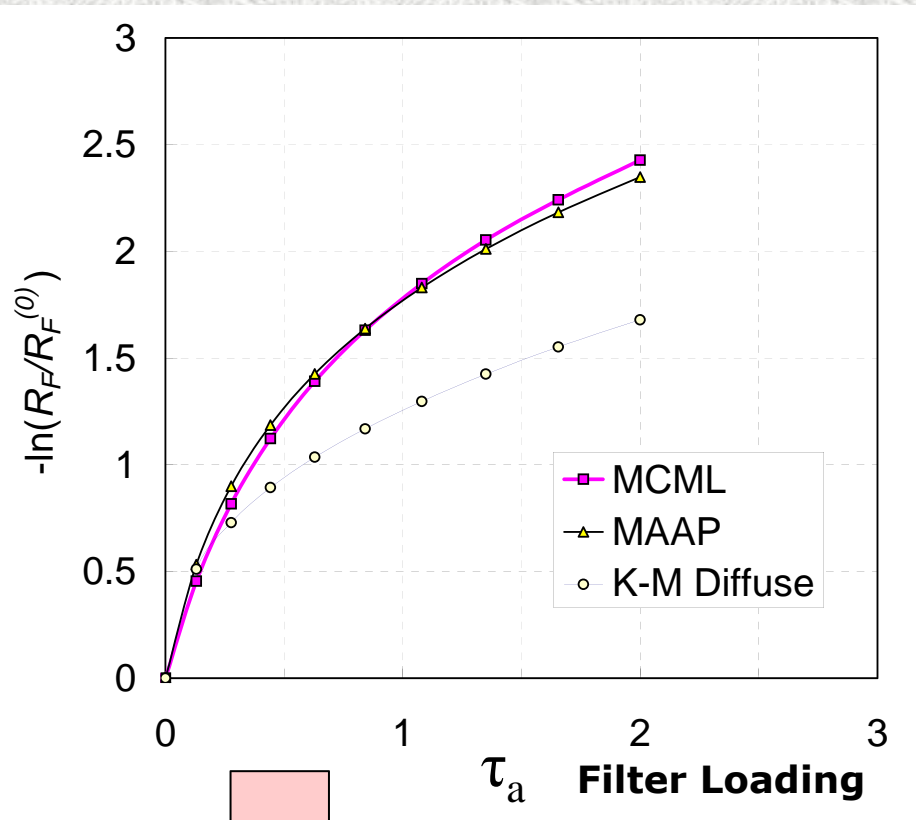

- **MCML**: Monte Carlo Simulation (reference method for two-layer model)
- **MAAP**: Code used by Multiple Angle Absorption Photometer
- **K-M**: Kubelka-Munk theory

Concurrent R and T Measurements Allow Estimation of Absorption Optical Depth

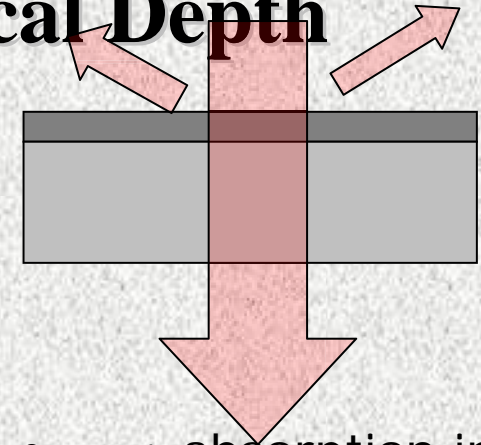
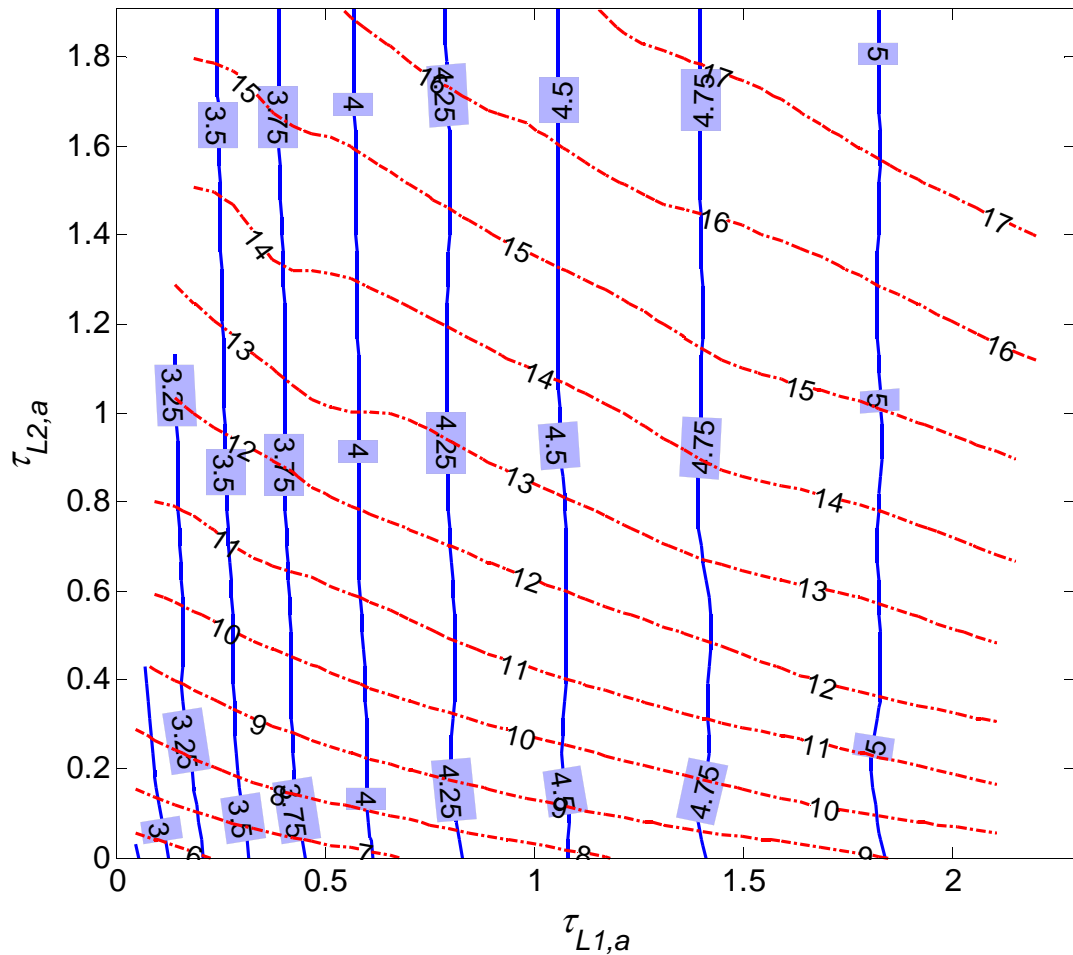

- $\tau_{L1,a}$: absorption in the first layer
- $\tau_{L2,a}$: absorption in the second layer
- Blue line: reflectance measure
- Red line: transmittance measure

- Absorption in the second layer has no impact on the reflectance
- Absorption in the first layer does not affect transmittance as much as absorption in the second layer

Retrieve OP and EC Absorption based on R and T Measurements

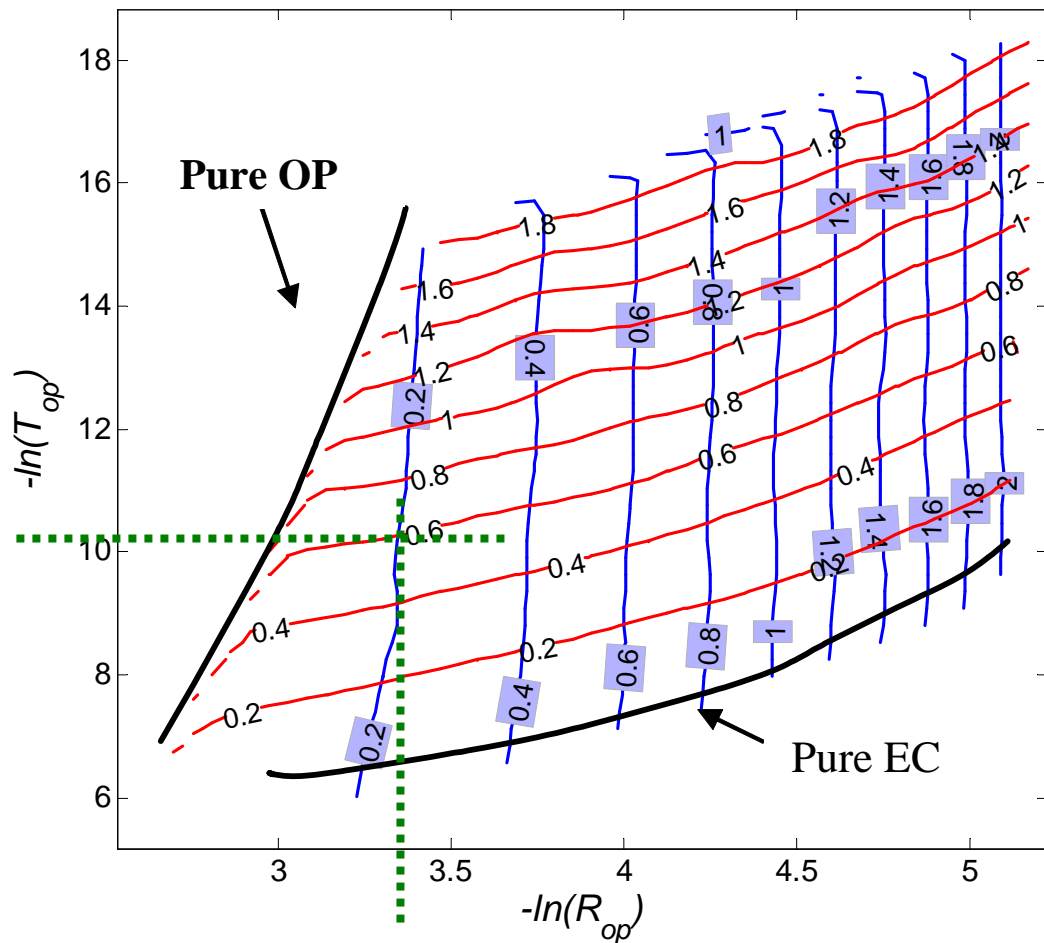

- Blue line: absorption in the first layer
- Red line: absorption in the second layer

Mass absorption efficiency varied by source (1047 nm)

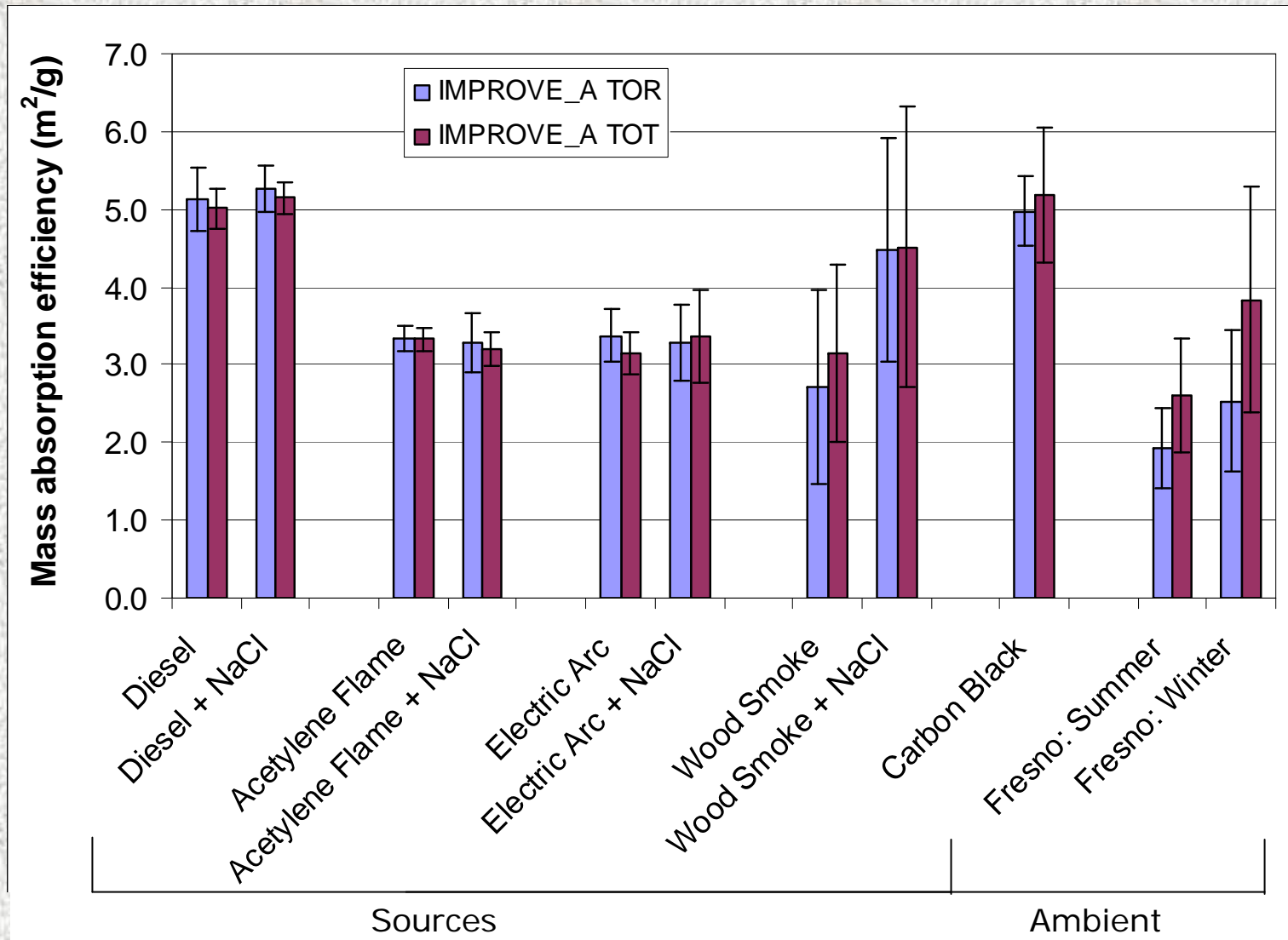

Size distribution varies by source

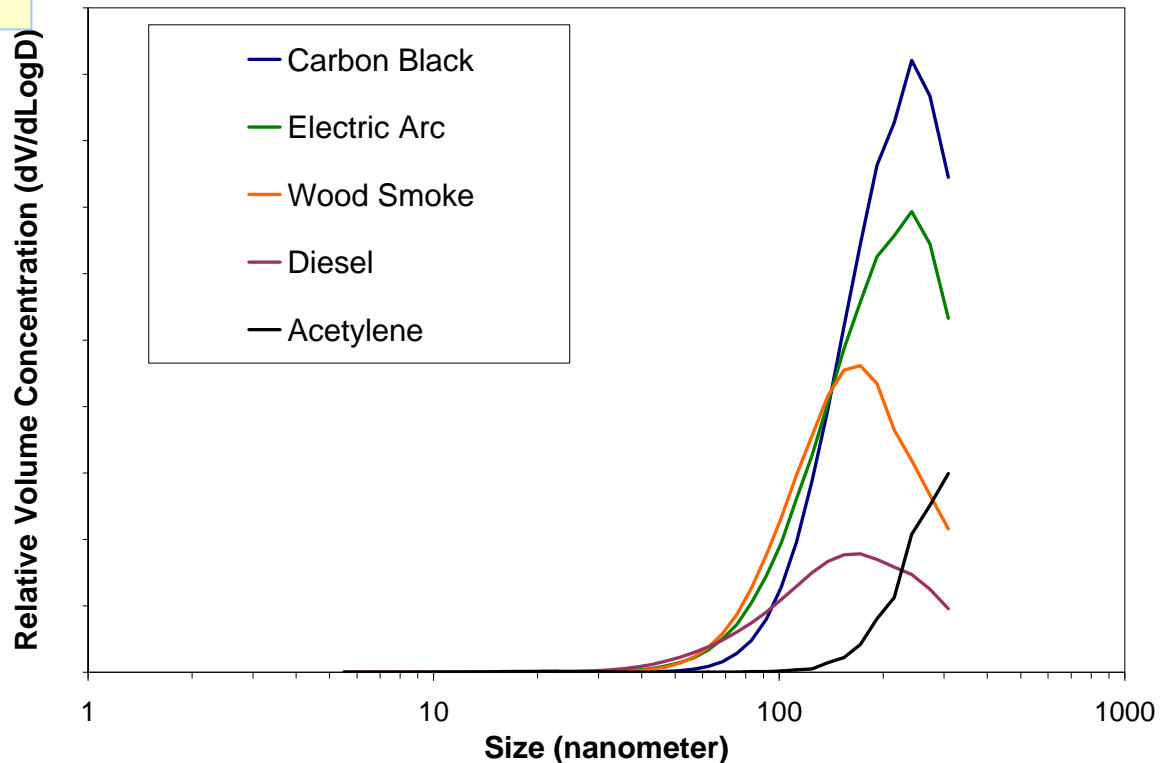
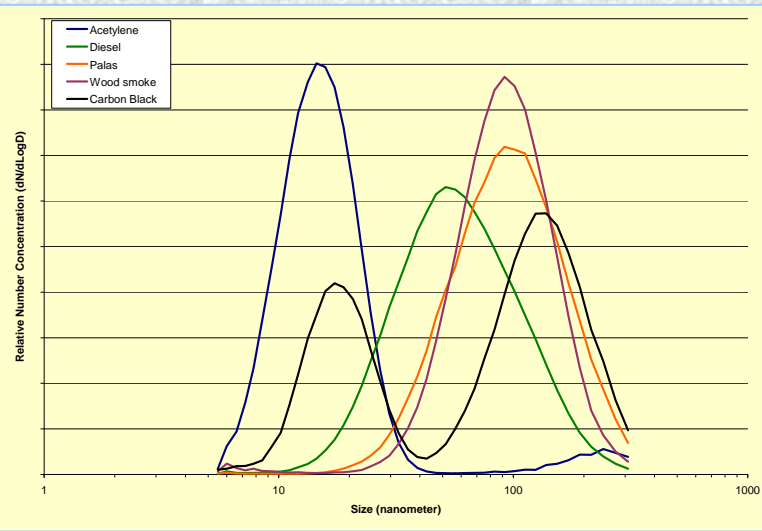

Mie-Scattering Model

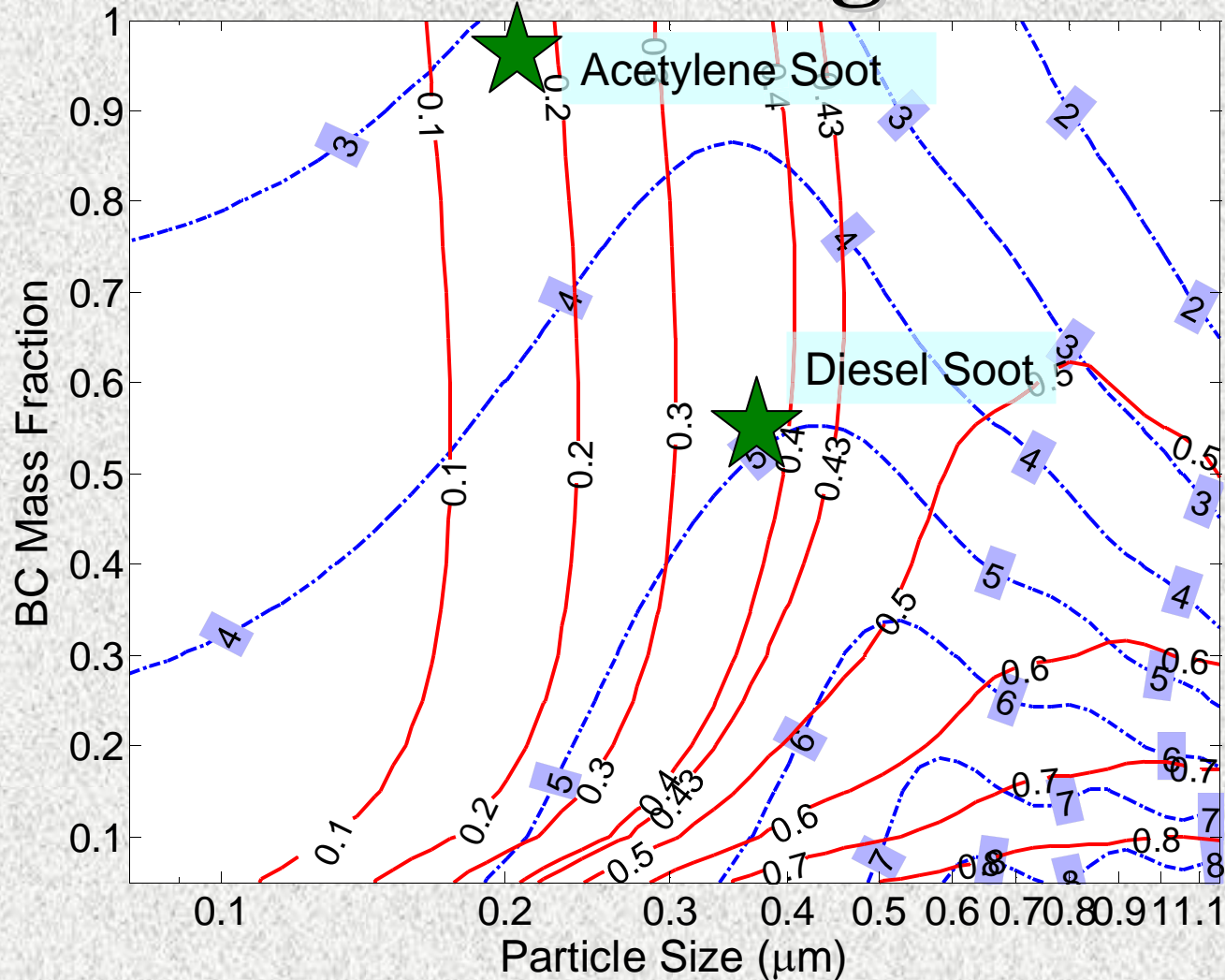

The blue lines indicate BC σ_{abs} at 1047 nm in m^2/g and the red lines indicate the single scattering albedo, ω . The refractive index and density for EC/BC are assumed to be $1.96 - 0.66i$ and $1.7 g/cm^3$, respectively (Chen et al., 2006). OM is modeled with a refractive index of $1.42 - 0.001i$ and density of $1.2 g/cm^3$.

Spectral Dependence of Light Absorption (Angstrom Power Law; $\lambda^{-\alpha}$)

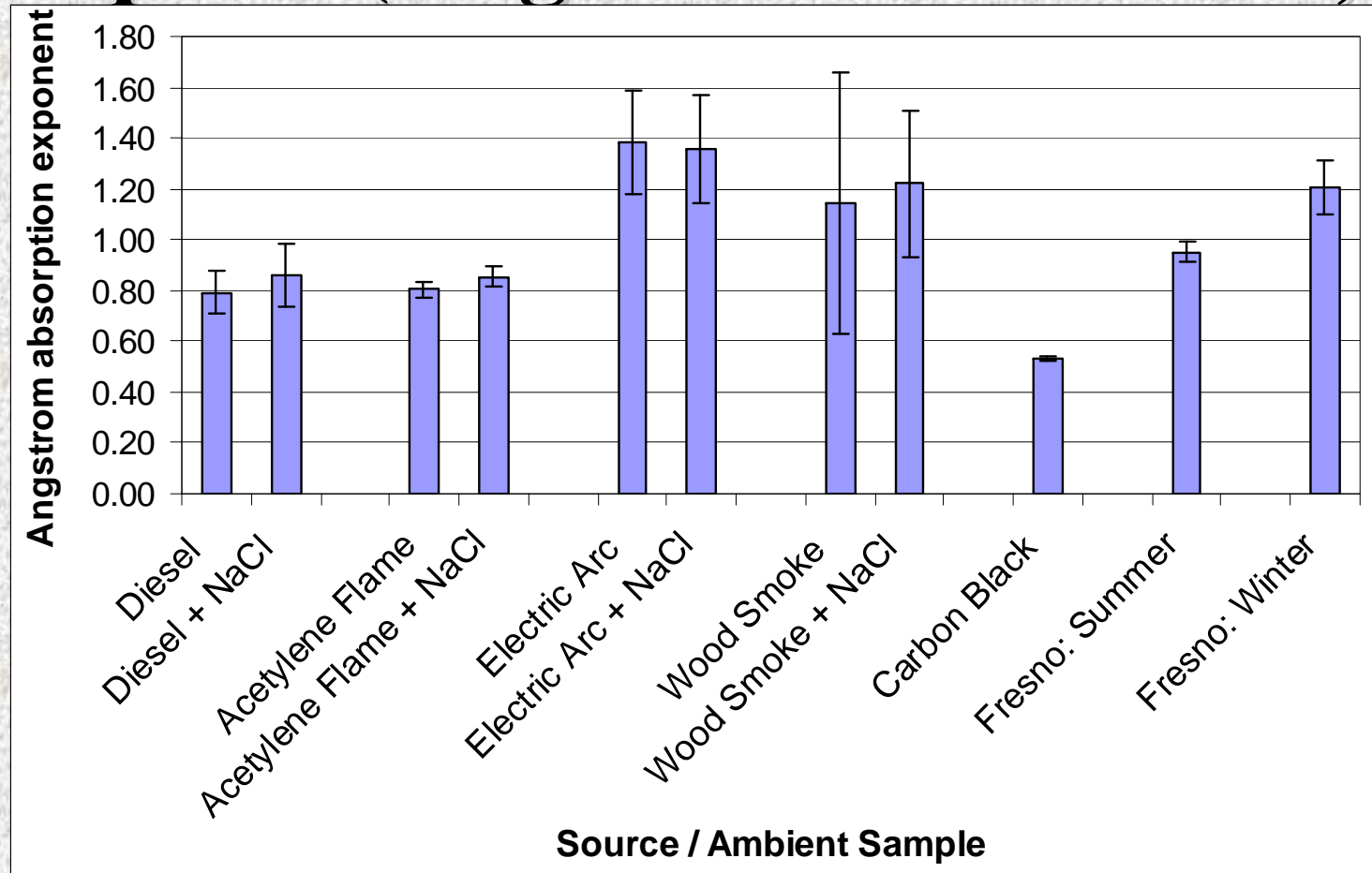

Estimate of the Angstrom absorption exponent, α , using 7-AE (seven wavelength aethalometer) measurements for different source and ambient samples. Error bars shown are one standard deviation from the mean.

Conclusions

- The IMPROVE_A protocol was developed to represent actual sample temperature and to maintain consistency in OC/EC measurements for IMPROVE and other networks.
- Temperature calibration and $O_2 < 100$ ppb auditing is necessary for thermal/optical methods.
- Small (20 to 40 °C) temperature differences do not affect the OC/EC split in TOR, but they do affect the TOT split and the carbon fractions.
- OC/EC split is insensitive to analytical conditions as long as reflectance correction is used.

Conclusions (continued)

- The presence of salts in samples increases EC oxidation rate at lower temperatures, thereby shifting thermal carbon fractions to lower temperature plateaus.
- Charring is minimized in the presence of $(\text{NH}_4)_2\text{SO}_4$, but not Na_2SO_4 .
- Due to the formation of char and EC decomposition at high temperatures w/o O_2 , optical correction is necessary in thermal methods to separate OC from EC.
- EC and OP have different absorption efficiencies. Optical correction should minimize the effects of the OP char.

Conclusions (continued)

- Pyrolyzed carbon (OP) is more abundant in ambient and wood smoke samples than in diesel and acetylene flame soot. This results in less consistent OC/EC splits for vegetative burning than for other EC sources.
- Low-temperature OC and high-temperature EC are relatively abundant in diesel soot but low in wood smoke PM.
- Under laboratory-controlled conditions, source samples can be reproduced within $\pm 10-15\%$ for diesel, acetylene flame, and electric arc soot, and within $\pm 40-50\%$ for wood combustion.
- Biomass fuel and combustion conditions (e.g., temperature) result in EC/TC abundances of 3 to 80%.

Conclusions (continued)

- Absorption efficiencies at 1047 nm from photoacoustic instruments yield 3 – 5 m²/g for EC from the IMPROVE, but are different for different sources.
- The absorption exponent is smaller for diesel and acetylene soot (~0.8) and larger for electric arc (PALAS) and wood smoke PM (>1).
- Optical properties cannot be fully explained by Mie theory (especially for wood smoke and electric arc PM) due to uncertain refractive indices and irregular particle shapes.
- Filter characteristics condition (thickness, refractive indices, particle penetration depth) need to be better specified to model OC/EC splits.

STAR Grant-Related Publications

2003 - 2004

- Chen, L.-W. A., Chow, J.C., Watson, J.G., Moosmüller, H., Arnott, W.P. (2004). Modeling reflectance and transmittance of quartz-fiber filter samples containing elemental carbon particles: Implications for thermal/optical analysis. *J. Aerosol Sci.* 35, 765-780, doi: 10.1016/j.jaerosci.2003.12.005.
- Chow, J.C., Watson, J.G., Chen, L.W., Arnott, W.P., Moosmüller, H., Fung, K.K. (2004). Equivalence of elemental carbon by thermal/optical reflectance and transmittance with different temperature protocols. *Environ. Sci. Technol.* 38 (16), 4414-4422.
- Ho, K.F., S.C. Lee, C.K. Chan, J.C. Yu, J.C. Chow, and X.H. Yao (2003). Characterization of chemical species in PM_{2.5} and PM₁₀ aerosols in Hong Kong. *Atmos. Environ.*, 37(1), 31-39.
- Ho, K.F., J.J. Cao, S.C. Lee, Y.S. Lee, J.C. Chow, J.G. Watson, and K. Fung (2004). Variability of levels, water soluble and isotopic composition of organic and elemental carbon in Hong Kong urban atmosphere. *Environ. Sci. Technol.*, submitted.
- Sin, D.W.M., W.H. Fung, Y.Y. Choi, C.H. Lam, P.K.K. Louie, J.G. Watson, and J.C. Chow (2004). Seasonal and spatial variation of solvent extractable organic compounds in fine suspended particulate matter in Hong Kong. *JAWMA*, 55(3):291-301.

STAR Grant-Related Publications

2005

- Arnott, W.P., B. Zielinska, C.F. Rogers, J. Sagebiel, K. Park, J.C. Chow, H. Moosmüller, J.G. Watson, K. Kelly, D. Wagner, A. Sarofim, J. Lighty, and G. Palmer (2005). Evaluation of 1047-nm Photoacoustic Instruments and Photoelectric Aerosol Sensors in Source-Sampling of Black Carbon Aerosol and Particle-Bound PAHs from Gasoline and Diesel Powered Vehicles. *Environ. Sci. Technol.*, **39**(14):5398-5406.
- Chow, J.C., J.G. Watson, P.K.K. Louie, L-W.A. Chen, and D. Sin (2005). Comparison of PM_{2.5} Carbon Measurement Methods in Hong Kong, China. *Environ. Poll.*, **137**(2):334-344.
- Chow, J.C., J.G. Watson, L.W.A. Chen, G. Paredes-Miranda, M.C.O. Chang, D. Trimble, K. Fung, H. Zhang, and J.Z. Yu (2005). Refining Temperature Measures in Thermal/Optical Carbon Analysis. *Atmos. Chem. And Physics Discuss.*, **5**:4477-4505.
- El-Zanan, H.S., D.H. Lowenthal, B. Zielinska, J.C. Chow, and N. Kumar (2005). Determination of the organic aerosol mass to organic carbon ratio in IMPROVE samples. *Chemosphere*, **60**(4):485-496.
- Watson, J.G., J.C. Chow, and L.W.A. Chen (2005). Summary of Organic and Elemental Carbon/Black Carbon Analysis Methods and Intercomparisons. *AAQR*, **5**(1):65-102.

STAR Grant-Related Publications

2006

- Chen, L.-W.A.; Moosmüller, H.; Arnott, W.P.; Chow, J.C.; Watson, J.G.; Susott, R.A.; Babbitt, R.E.; Wold, C.; Lincoln, E.; and Hao, W.M. (2006). Particle emissions from laboratory combustion of wildland fuels: In situ optical and mass measurements. *Geophys. Res. Lett.*, 33(L04804):1-4.
- Chow, J.C.; Watson, J.G.; Lowenthal, D.H.; Chen, L.-W.A.; and Magliano, K. (2006). Particulate Carbon Measurements in California's San Joaquin Valley. *Chemosphere*, 62(3):337-348.
- Chow, J.C.; Watson, J.G.; Park, K.; Lowenthal, D.H.; Robinson, N.F.; and Magliano, K. (2006). Comparison of Particle Light Scattering and Fine Particulate Matter Mass in Central California. *JAWMA*, 56(4)398-410.
- Chow, J.C.; Watson, J.G.; Lowenthal, D.H.; Chen, L.-W.A.; Zielinska, B.; Rinehart, L.R.; and Magliano, K. (2006). Evaluation of organic markers for chemical mass balance source apportionment at the Fresno Supersite. *Atmos. Chem. Phys.*, <http://www.atmos-chem-phys.net/7/1741/2007/acp-7-1741-2007.pdf>.
- Chow, J.C., J.G. Watson, D.H. Lowenthal, L.-W.A. Chen, and K. Magliano (2006). Particulate Carbon Measurements in California's San Joaquin Valley. *Chemosphere*, in press.
- Park, K.; Chow, J.C.; Watson, J.G.; Trimble, D.L.; Doraiswamy, P.; Arnott, W.P.; Stroud, K.R.; Bowers, K.; Bode, R.; Petzold, A.; and Hansen, A.D.A. (2006). Comparison of continuous and filter-based carbon measurements at the Fresno Supersite. *J. Air Waste Manage. Assoc.*, 56(4):474-491.
- Park, K., J.C. Chow, J.G. Watson, W.P. Arnott, D. Trimble, K. Stroud, K. Bowers, R. Bode, A. Petzold, and A.D.A. Hansen (2006). Comparison of Continuous and Filter-Based Carbon Measurements at the Fresno Supersite. *JAWMA*, in revision.

STAR Grant-Related Publications

2007

- Chen, L.-W.A.; Chow, J.C.; Watson, J.G.; Lowenthal, D.H.; and Chang, M.C. (2007). Particle emissions from laboratory combustion of wildland fuels: Emission factors and source profiles. *Environ. Sci. Technol.*, in press.
- Chow, J.C.; Watson, J.G.; Chen, L.-W.A.; Chang, M.C.O.; Robinson, N.F.; Trimble, D.L.; and Kohl, S.D. (2007). The *IMPROVE_A* temperature protocol for thermal/optical carbon analysis: Maintaining consistency with a long-term data base. *J. Air Waste Manage. Assoc.*, 57:accepted.