

US EPA ARCHIVE DOCUMENT

A topographic map of the Lake Erie basin, showing the lake and its surrounding landmasses in shades of green and brown. A red outline traces the perimeter of the lake and its immediate surroundings, highlighting the study area. The text is overlaid on the map.

Linking Landscapes and Fisheries of the Lake Erie Ecosystem

Joseph F. Koonce

Case Western Reserve University

Benjamin F. Hobbs

Johns Hopkins University

Objectives of Presentation

- ◆ Review project goals
- ◆ Update progress towards goals during year 2 of the research
- ◆ Show some results
- ◆ Review plans for year 3



Project Goals

- ◆ **Develop a regional-scale, stressor-response model for the management of the Lake Erie ecosystem**
 - Stressors: land use changes, nutrients, habitat alteration, flow regime modification, exotic species, and fisheries exploitation**
- ◆ **Incorporate model into a multi-objective decision making tool for use by Lake Erie managers**



Project task structure

- ◆ Linking changes in watershed habitat and nutrient loading to Lake Erie ecosystem health
- ◆ Quantifying uncertainties in model predictions the effects of uncertainties on management decisions
- ◆ Evaluating cross-scale interaction of stressors
- ◆ Developing tools to evaluate ecological risk of land-use changes
- ◆ Identifying and evaluate critical break-points in ecosystem and management integrity



Year 2 Accomplishments

- ◆ Completed testing of models for establishing habitat supply inventory for Lake Erie watershed
- ◆ Established a functional dependence of tributary flow and nutrient loading on land cover
- ◆ Assembled a component-based DEVS modeling and simulation framework to perform cross-scale analysis of the interaction of stressors
- ◆ Developed and began testing a decision analysis framework to explore the trade-offs associated with dam removal



Functional Integration of Habitat

**Human
Activities**

**Landuse/
Land Cover**

Climate

**System
Hydrology**

**Nutrient
Loading**

**Fish
Habitat**

Productivity

Recruitment



November 3, 2005

EPA STAR Project Review

6



Estimation of Habitat Availability



Habitat modeling

- ◆ Apply geomorphic principles to estimation of instream fish habitat
- ◆ Generate regional scale habitat supply inventories for the entire Lake Erie drainage basin



Geomorphologic Principles

◆ Drainage Area is related to:

- Depth*Velocity
- Discharge/Width
- Bankfull Width
- Bankfull Depth

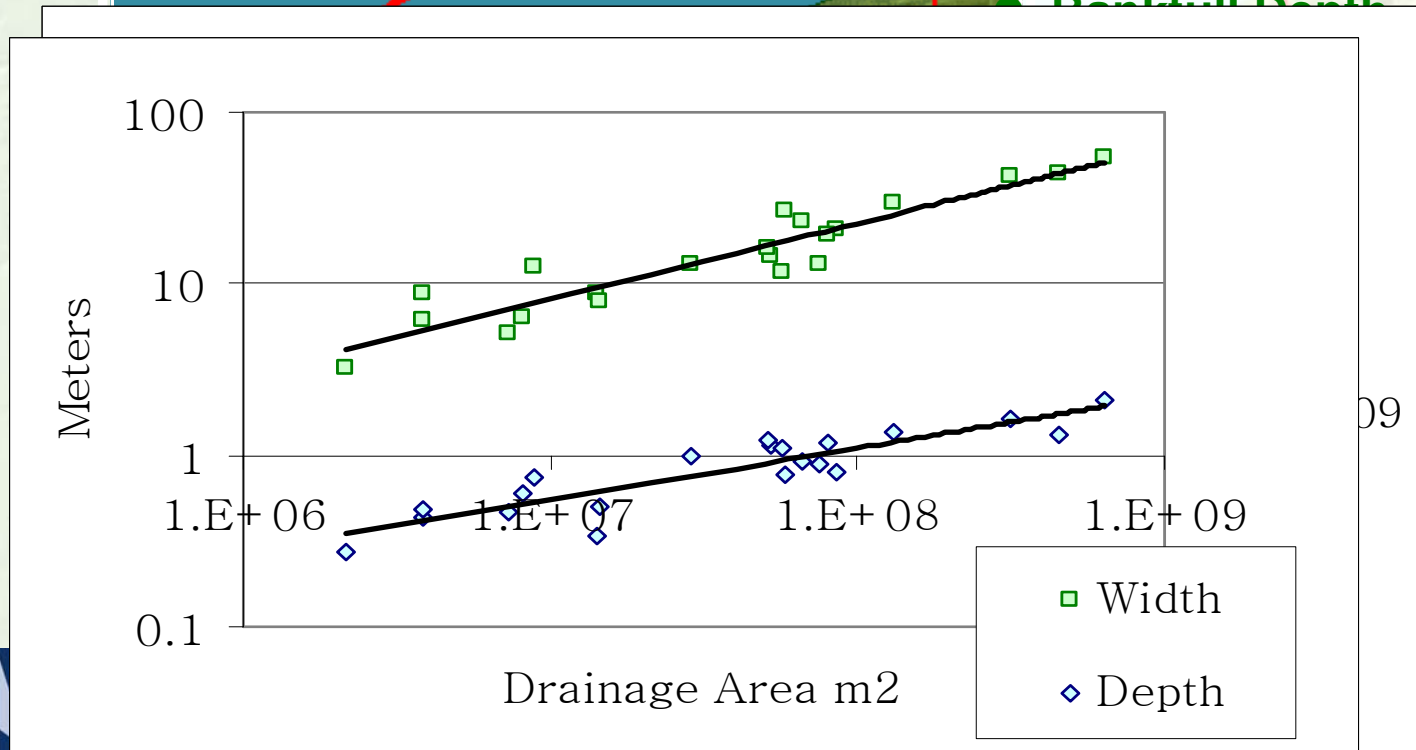

Geomorphologic Principles

◆ Median Substrate Size (D50) is related to Stream Power

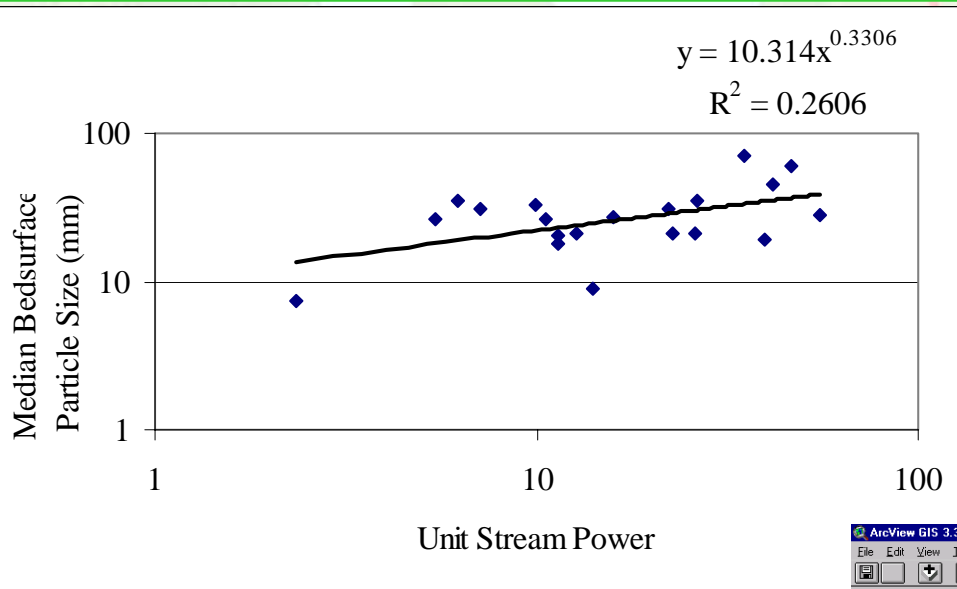

◆ Power is a function of:

- Drainage Area
- Stream slope

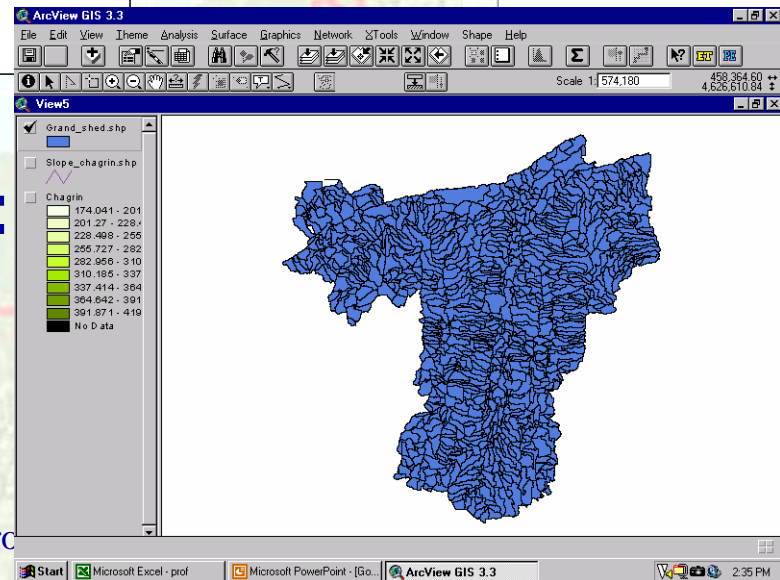

Applying GIS—Estimates of Slope

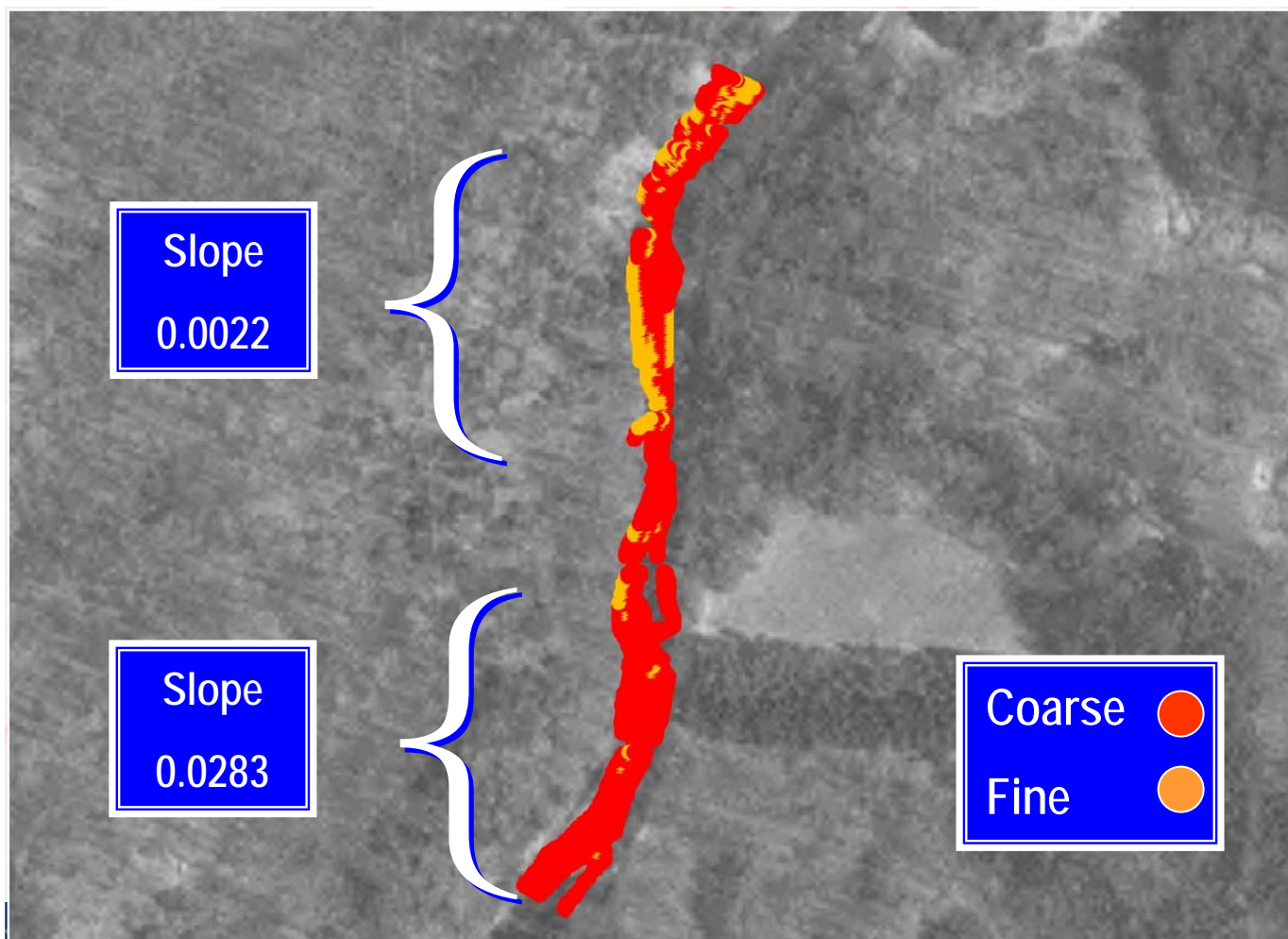

Applying GIS-Estimates of Median Particle Size

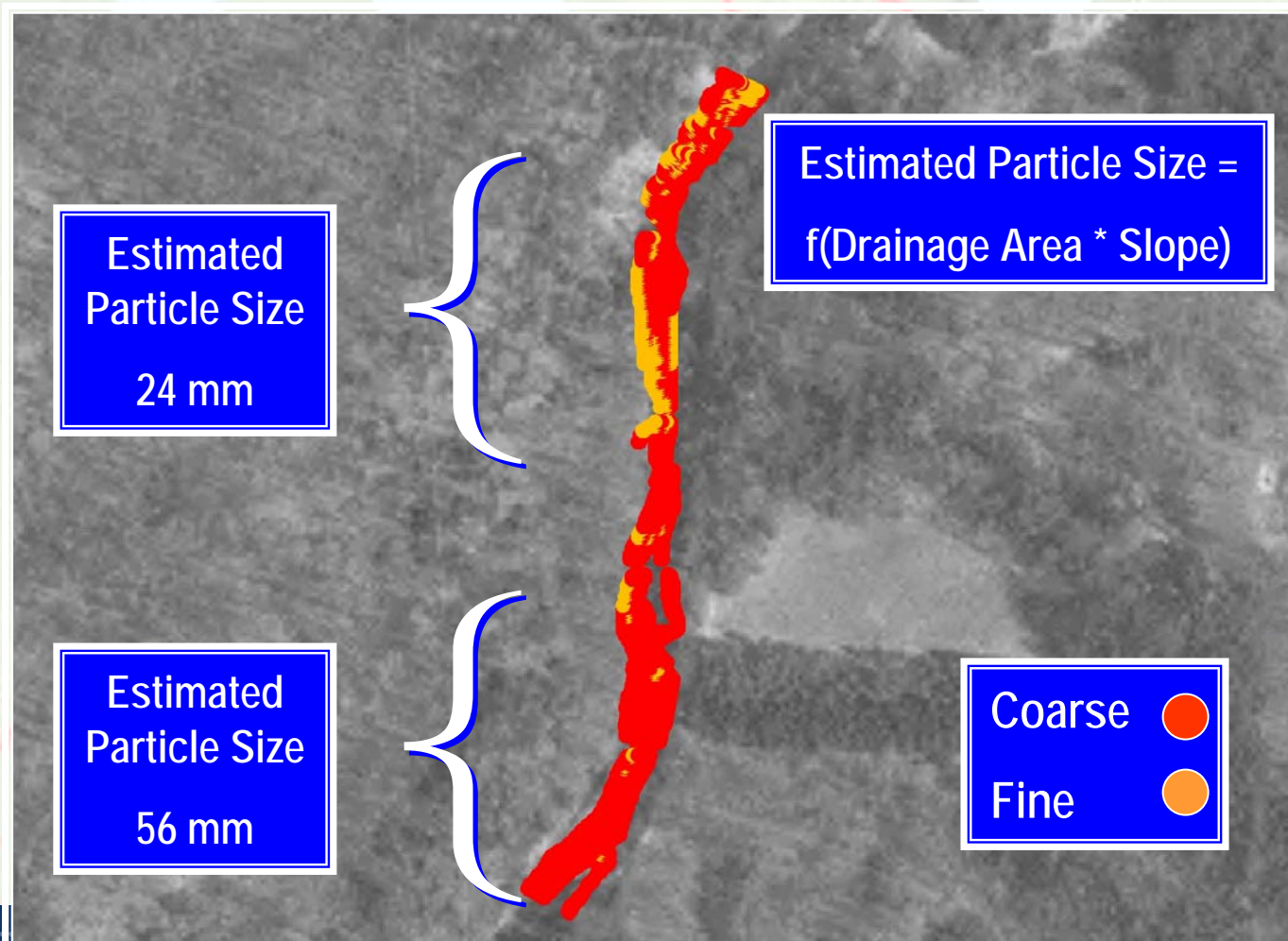

Scale Dependence of Slope Estimates

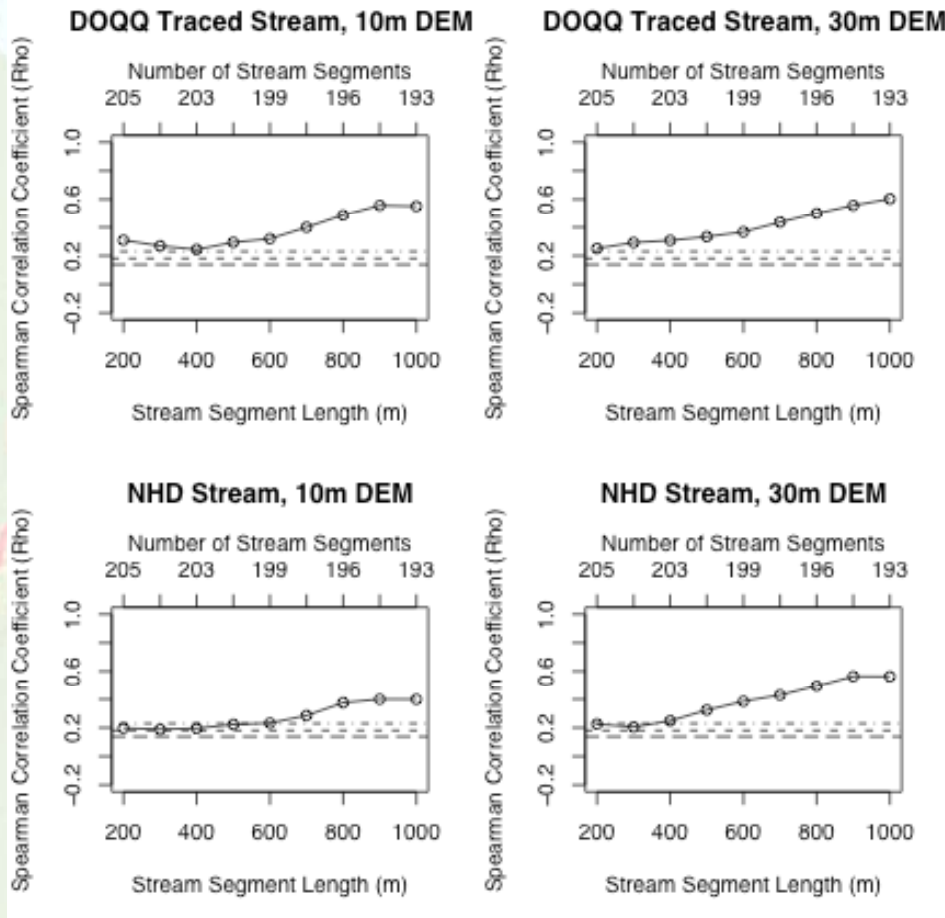

Effects of Scale on Flow Predictions

Rocky River, Ohio. IHACRES Predictions

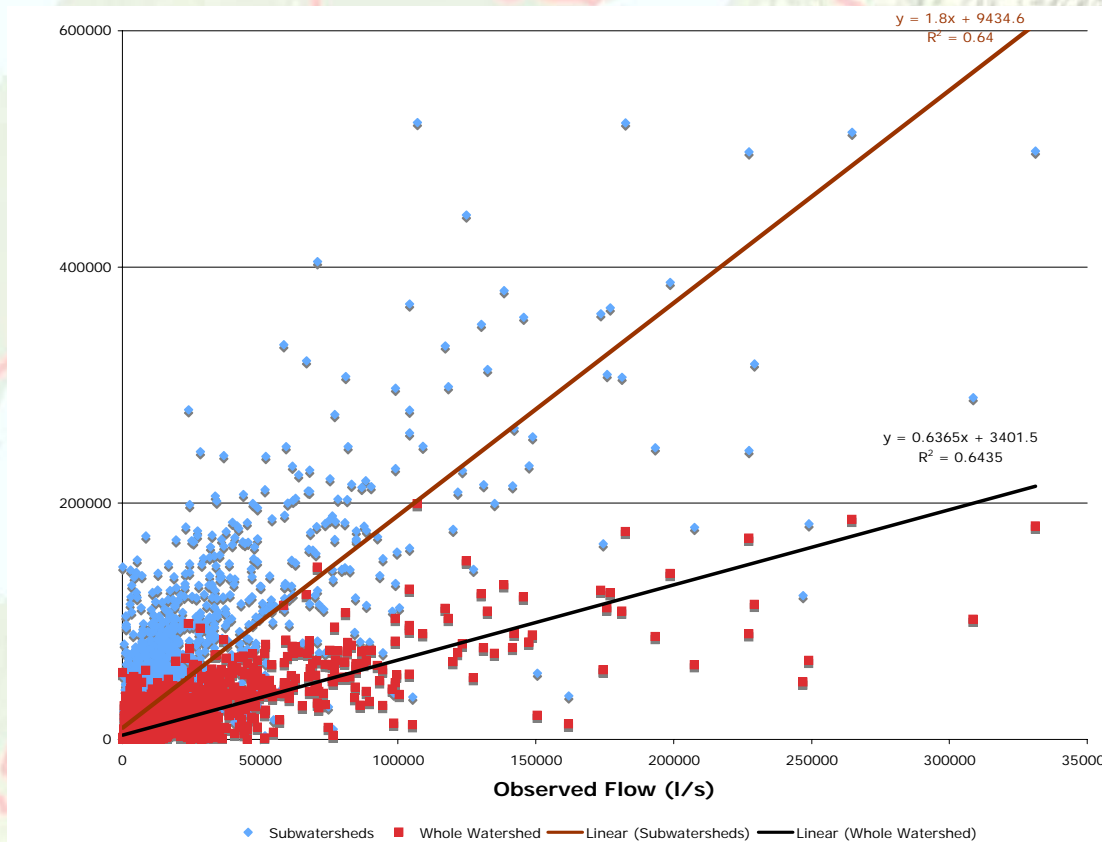
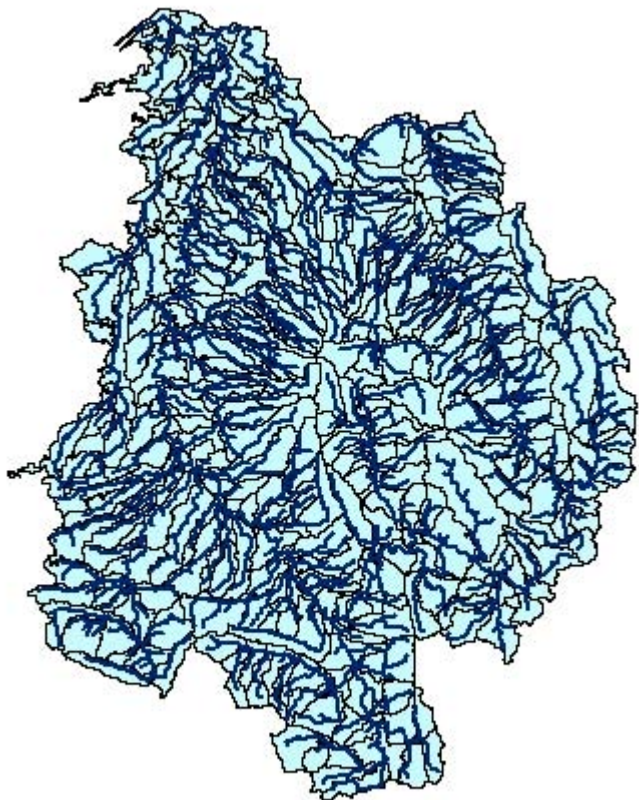

Model Implementation

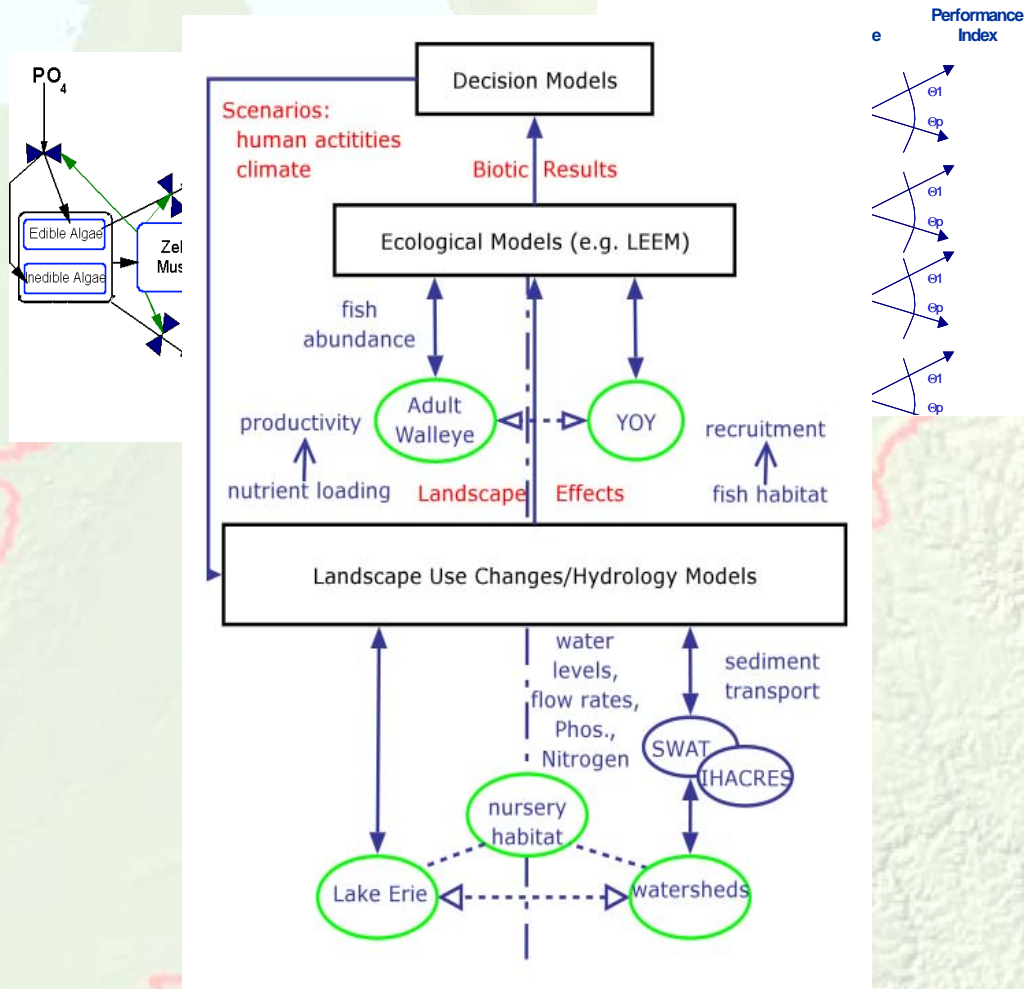

Modeling and Simulation Framework

UML Representation of Lake Erie Model Hierarchy

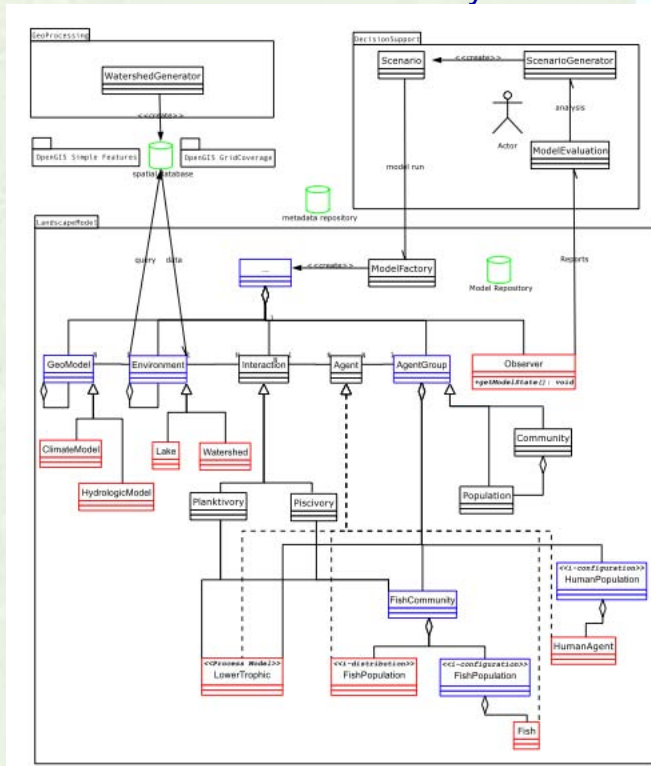

Component-based DEVS Modeling and Simulation Framework

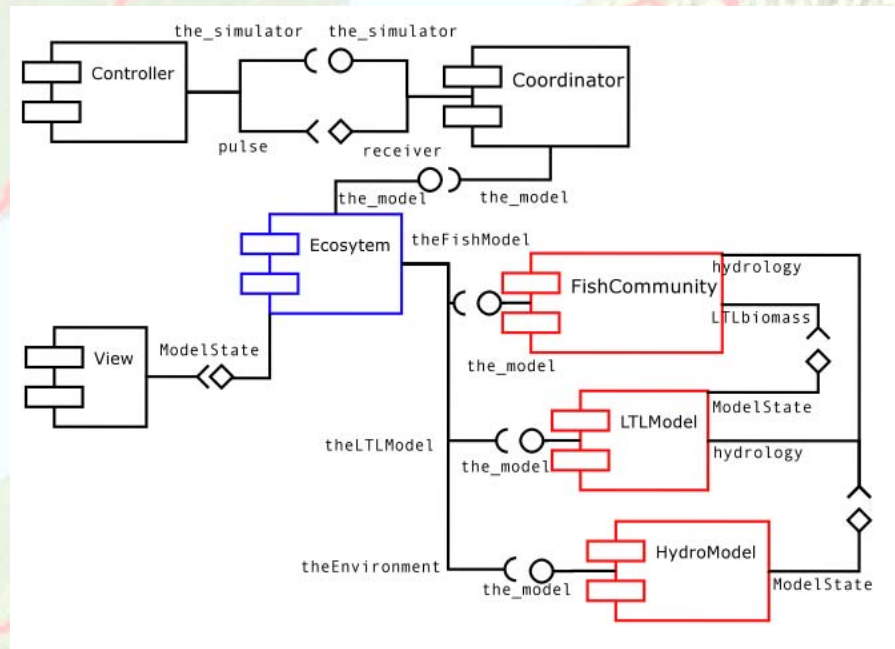

Decision Applications

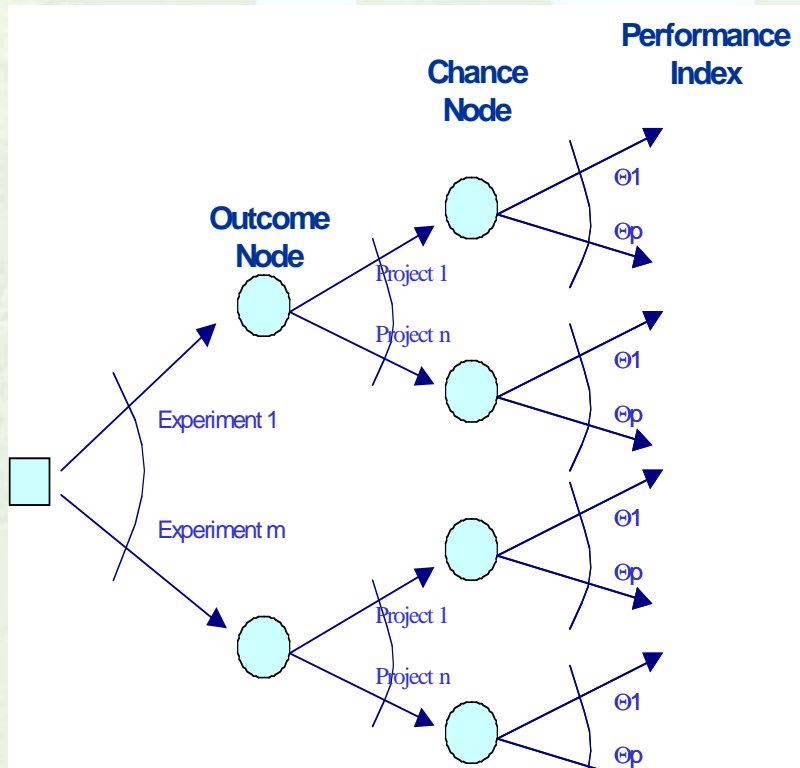

◆ Dams

Dam removal creates a trade-off between control of sea lamprey and exploitation of Lake Erie fish populations

◆ Priority Conservation Areas

Ohio Balanced Growth Initiative priority--establish a scientific foundation for demarcation of PCAs



Next Steps

- ◆ Identification and evaluation of critical break-points in ecosystem integrity of the Lake Erie ecosystem and of its integrated management.
- ◆ Continue engagement with landscape management policy issues in the Lake Erie Balance Growth Initiative.
 - PCA demarcation criteria—linked to TMDL
 - Join with the Chagrin River Watershed Partners to evaluate the effects of implementing best management practices for runoff control
- ◆ With Lake Erie fisheries management agencies, analyze interacting stresses affecting the fish community of Lake Erie and to test our decision-making tools



Acknowledgements

CWRU:

Peter Whiting

Jon Cline

Ann Marie Gorman

Tom Neeson

Catherine Cortright

Univ Akron

Shiva Sastri

JHU:

Ben Hobbs

Pearl Zheng

Hong Li

Agency Collaborators

Mike Fodale, USFWS

Les Stanfield, OMNR

Great Lakes Fishery Commission

Department of Fisheries & Oceans, Canada

Chagrin River Watershed Partners



November 3, 2005

EPA STAR Project Review

19



