

US EPA ARCHIVE DOCUMENT

Waste Analysis at Facilities that Generate, Treat, Store, and Dispose of Hazardous Wastes - **DRAFT 2**

A Guidance Manual



US EPA ARCHIVE DOCUMENT

Generation/
Treatment

Storage

Land
Disposal



DISCLAIMER

This guidance represents EPA's current thinking on this topic. It does not create or confer any rights for or on any person or operate to bind the public. You can use an alternative approach if the approach satisfies the requirements of the applicable statutes and regulations. If you want to discuss an alternative approach (you are not required to do so), you may contact the EPA staff responsible for implementing this guidance. In addition, please note that state hazardous waste programs may be more stringent and/or broader in scope than the federal program. If you cannot identify the appropriate EPA staff, call the number listed in the Acknowledgment.

ACKNOWLEDGMENT

This guidance document was developed by the U.S. Environmental Protection Agency's Office of Resource Conservation and Recovery and was funded under EPA Contract No. EP-W-10-056. For questions about the document, please contact the Work Group Chair: Gail Hansen, 703-308-0463, hansen.gail@epa.gov.

EPA wishes to acknowledge and thank the following EPA and state representatives for providing input into the guidance: Mary Andrews (OGC), Jim Aycock (EPA Region 7), Emily Chow (OECA), Jace Cuje (ORD), Laura Dahlgren (Georgia), Darleen Groner (Missouri), Vishnu Katari (OECA), Christopher Lambesis (EPA Region 5), Sharon Leitch (EPA Region 1), Beth Lohman (Virginia), Maliha Nash (ORD), Liz McCarthy (EPA Region 1), Todd Ramaly (EPA Region 5), Wray R. Rohrman (EPA Region 7), Tracy Sheppard (OGC), Jan Simmons (Georgia), Steve Simoes (Vermont), Don J. Smith (NEIC), Amy Walden (Wisconsin), and Stephen Yee (EPA Region 1).

Table of Contents

Acronym List	iv
Introduction.....	1
PART ONE: RCRA Waste Analysis – An Overview.....	1-1
1.0 What Waste Analysis Requirements Must You Meet?.....	1-1
1.1 Generator and TSDF Waste Analysis Requirements.....	1-3
1.1.1 Generator Waste Analysis Requirements	1-3
1.1.2 TSDF Waste Analysis Requirements	1-8
1.1.3 Transmitting Waste Analysis Information	1-12
1.2 How Can You Meet The Waste Analysis Requirements For Your Facility?.....	1-13
1.2.1 Sampling and Analysis for TSDFs	1-15
1.2.2 Acceptable Knowledge and TSDFs.....	1-18
1.2.3 Waste Analysis for Generators.....	1-22
PART TWO: Documenting and Conducting Waste Analysis	2-1
2.0 Developing a WAP and Conducting Waste Analysis.....	2-1
2.1 Content and Organization of the WAP	2-1
2.2 Facility Description	2-6
2.2.1 Description of Facility Processes and Activities.....	2-6
2.2.2 Identification/Classification of Hazardous Wastes Generated or Managed at Your Treatment, Storage and Disposal Facility	2-7
2.2.3 Description of Hazardous Waste Management Units	2-8
2.3 Systematic Planning.....	2-10
2.4 Selecting Waste Analysis Parameters.....	2-15
2.4.1 Criteria for Parameter Selection.....	2-16
2.4.2 Parameter Selection Process.....	2-19
2.4.3 Rationale for Parameter Selection	2-21
2.4.4 Special Parameter Selection Requirements	2-21
2.5 Selecting Sampling Procedures.....	2-26
2.5.1 Sampling Strategies and Sampling Frequencies	2-26
2.5.2 Selecting Sample Equipment.....	2-34
2.5.3 Maintaining and Decontaminating Field Equipment.....	2-40
2.5.4 Sample Preservation and Storage	2-41
2.5.5 Establishing Quality Assurance/Quality Control Procedures	2-41
2.5.6 Establishing Health and Safety Protocols	2-44
2.6 Selecting a Laboratory and Laboratory Analytical Methods.....	2-46
2.6.1 Selecting a Laboratory.....	2-46
2.6.2 Selecting Laboratory Analytical Methods.....	2-50
2.7 Quantifying Data Uncertainty.....	2-54

2.8 Determining Re-Evaluation Frequencies 2-57

2.9 Special Procedural Requirements..... 2-60

 2.9.1 Procedures for Receiving Wastes Generated Off-Site..... 2-60

 2.9.2 Procedures for Combustion Facilities..... 2-62

 2.9.3 Procedures for Ignitable, Reactive, and Incompatible Waste 2-65

 2.9.4 Procedures for Complying with LDR Requirements 2-66

2.10 Discrepancy Policy 2-67

 2.10.1 Manifest Discrepancies 2-67

 2.10.2 Discrepancies Between Incoming Waste and Profile 2-68

2.11 Rejection Policy 2-69

2.12 Recordkeeping 2-69

2.13 Corrective and Preventative Action Measures 2-72

PART THREE: Checklist3-1

PART FOUR: Sample WAPs.....4-1

Example WAP 1: Waste Analysis Plan for ACE Chemical Services 4-2

Example WAP 2: Waste Analysis Plan of Container Management Incorporated (CMI)..... 4-33

APPENDICES

APPENDIX A: Hazardous Waste Identification A-1

APPENDIX B: Regulatory Summary B-1

APPENDIX C: Regulatory Citations for Conducting Waste Analysis C-1

APPENDIX D: Overview of Major Hazardous Waste Management Units D-1

APPENDIX E: Glossary of Terms E-1

APPENDIX F: Key Considerations and Tips..... F-1

APPENDIX G: References G-1

List of Tables

TABLE 2-1: Reference Guide to Key Issues for Consideration When Developing WAPs	2-4
TABLE 2-2: Description of Listed Wastes	2-7
TABLE 2-3: Description of Characteristic Waste	2-8
TABLE 2-4: Sampling Approach Overview	2-29
TABLE 2-5: Major Sample Types	2-31
TABLE 2-6: Applicability of Sampling Equipment to Wastestreams	2-37
TABLE 2-7: Important QA Elements	2-47
TABLE 2-8: Laboratory QC Techniques	2-49
TABLE 2-9: Re-Evaluation Frequencies	2-59

List of Figures

FIGURE 1-1: Summary of Generator Analytical Requirements	1-5
FIGURE 1-2: Analytical Requirements for LQGs under Subparts AA, BB, and CC of 40 CFR Part 265	1-6
FIGURE 1-3: Summary of TSDF Analytical Requirements	1-11
FIGURE 1-4: Waste Analysis Data Flow	1-13
FIGURE 1-5: Waste Analysis Quality – Conceptual Model	1-15
FIGURE 2-1: The Seven Steps of the DQO Process	2-10
FIGURE 2-2: Waste Analysis Parameter Selection Process	2-20
FIGURE 2-3: Illustration of Simple Random, Stratified Random and Systematic Random Sampling	2-30
FIGURE 2-4: Samplers for Liquid Wastestreams	2-38
FIGURE 2-5: Samplers for Solid Wastestreams	2-39
FIGURE 2-6: Example Chain-of-Custody Record	2-45
FIGURE 2-7: Analytical Methods Selection Flowchart	2-53
FIGURE 2-8: Shipment Screening	2-61
FIGURE 2-9: Example Waste Profile Sheet	2-73

Acronym List

AA	Atomic Absorption	MS	Mass Spectrometer
AES	Atomic Emission Spectroscopy	NELAP	National Environmental Laboratory Accreditation Program
AK	Acceptable Knowledge		
ASTM	American Society for Testing and Materials	NIOSH	National Institute for Occupational Safety and Health
BIF	Boiler and Industrial Furnace	NTIS	National Technical Information Service
BTU	British Thermal Units		
CAA	Clean Air Act	NSCEP	National Service Center for Environmental Publications
CESQG	Conditionally Exempt Small Quantity Generators	NWW	Non-Wastewater
CFR	Code of Federal Regulations	OSHA	Occupational Safety and Health Administration
CWA	Clean Water Act	PCB	Polychlorinated Biphenyls
DOT	Department of Transportation	POHC	Principle Organic Hazardous Constituent
DQO	Data Quality Objectives	ppm	parts per million
EPA	Environmental Protection Agency	QA	Quality Assurance
FAP	Feedstream Analysis Plan	QC	Quality Control
FR	Federal Register	RCRA	Resource Conservation and Recovery Act
GC	Gas Chromatography	SDS	Safety Data Sheet
HCl	Hydrochloric Acid	SOP	Standard Operating Procedure
H&S	Health and Safety	SQG	Small Quantity Generators
HW	Hazardous Waste	TC	Toxicity Characteristic
HWC	Hazardous Waste Combustors	TCLP	Toxicity Characteristic Leaching Procedure
ICP	Inductively Coupled Plasma	TSDF	Treatment, Storage, or Disposal Facility
LDR	Land Disposal Restrictions	UHC	Underlying Hazardous Constituent
LQG	Large Quantity Generators	WAP	Waste Analysis Plan
LQM	Laboratory Quality Manual	WPS	Waste Profile Sheet
LWAK	Light Weight Aggregate Kiln	WW	Wastewater
MACT	Maximum Achievable Control Technology		
MDP	Method-Defined Parameter		
mg/L	milligrams per liter		
MIR	Methods Innovation Rule		

Introduction

The purpose of this guidance manual is to discuss how a person can perform waste analyses and develop waste analysis plans (WAPs) in accordance with the federal hazardous waste regulations of the Resource Conservation and Recovery Act (RCRA), as amended. The federal hazardous waste regulations are codified at 40 CFR Parts 260 through 279. The primary audiences for this manual are hazardous waste generators and owner/operators of treatment, storage, and disposal facilities (TSDFs). This manual can also provide guidance in the development of used oil processor or re-refiner analysis plans under 40 CFR Part 279. In addition, the manual can be helpful to federal and state permit writers in evaluating WAPs and enforcement personnel in determining whether a facility is in compliance with its WAP requirements. **Note: In discussing the WAP, this manual presents federal hazardous waste requirements. Because state hazardous waste programs may be more stringent and/or broader in scope than the federal program, you need to consult your state's regulations to learn the requirements that apply to you.**

This manual achieves the following objectives:

Part One

- Explains the general requirements in the federal hazardous waste regulations for developing a WAP and/or conducting waste analysis.

Part Two

- Presents general and facility-specific guidance on the procedures for developing a useful WAP and conducting waste analysis.

Part Three

- Provides a checklist to assist you in conducting waste analysis and preparing a WAP.

Part Four

- Offers facility-specific WAP examples.

The previous edition of this manual was issued in 1994.¹ This current edition includes important updates and a greater focus on issues of particular importance to waste analyses. For example, it includes an expanded discussion in Part Two on how to integrate Data Quality Objectives into sampling/analysis activities. It also includes new WAP examples in Part Four. These examples are meant to give permit applicants and permit writers ideas to consider when preparing or approving a WAP. This manual also includes information on some changes to the federal RCRA program concerning waste analysis requirements that were promulgated

¹ The 1994 edition can be found at: <http://www.epa.gov/epawaste/hazard/tsd/ldr/wap330.pdf>.

since the last manual was published (e.g., new regulations). The following is a list of these program changes:

- Definition of solid waste final rule.
- Alternative requirements for laboratories owned by eligible academic entities.
- Conditional exemptions for military munitions.
- Conditional exemptions for low-level mixed waste storage, treatment, transportation, and disposal.
- Organic air emission standards for tanks, containers and surface impoundments [40 CFR Part 264 and 265, Subpart CC]
- Amendments to the Land Disposal Restrictions (LDR) regulations, including the Phase II - IV rules
- Revisions and updates to the “Test Methods for Evaluating Solid Waste, Physical/ Chemical Methods” (SW-846) and issuance of the Methods Innovation Rule (MIR).

The above referenced program changes are summarized in Appendix B of this manual. Refer to Appendix E for a glossary of terms.

PART ONE: RCRA Waste Analysis – An Overview

1.0 What Waste Analysis Requirements Must You Meet?

The cornerstone of the RCRA hazardous waste program is the requirement of generators and owner/operators of treatment, storage and disposal facilities (TSDFs) to properly identify and characterize, through waste testing and/or acceptable knowledge, all hazardous wastes that are generated, treated, stored, or disposed of at their site or facility.² Waste testing involves identifying and verifying the chemical and physical characteristics and composition of a waste by performing a detailed chemical and physical analysis of a representative sample of the waste. A facility may also apply acceptable knowledge of the waste in lieu of testing the waste. Proper waste analysis³ is needed to:

- Determine whether your waste is a RCRA hazardous waste under applicable federal and state requirements (which can be more stringent and/or broader in scope than the federal program).
- Classify the waste according to RCRA.
- Ensure that the waste is managed properly.
- Ensure you are complying with permitted feedrate or other numerical limitations (e.g., metal feedrates) at your facility if applicable.

Waste analysis, therefore, is the pivotal activity for properly ensuring that your facility (and any subsequent handlers) complies with the applicable regulations for proper waste treatment, storage, or disposal.

The majority of RCRA's waste analysis requirements apply to hazardous waste generators and TSDFs. The RCRA generator standards primarily apply to

General References on the RCRA Program

- EPA regulations (Title 40)
<http://www.gpo.gov/fdsys/>
- RCRA Orientation Manual
<http://www.epa.gov/epawaste/inforesources/pubs/orientat/>
- RCRA Online (database)
<http://www.epa.gov/epawaste/inforesources/pubs/orientat/>
- RCRA Training Modules
<http://www.epa.gov/epawaste/inforesources/pubs/rmods.htm>
- Envirofacts (database)
<http://www.epa.gov/enviro/index.html>
- RCRAInfo (database)
<http://www.epa.gov/enviro/facts/rcrainfo/index.html>
- TSDF Tool
<http://www.epa.gov/epawaste/hazard/tsd/permit/tsd-reggs/tsdf-ref-doc.pdf>

² This manual presents federal hazardous waste requirements. Because state hazardous waste programs may be more stringent and/or broader in scope than the federal program, you should consult your state's regulations to learn the requirements that apply to you.

³ Use of the phrase "waste analysis" refers to both waste testing and applying acceptable knowledge.

large quantity generators (LQGs) and small quantity generators (SQGs).⁴ Briefly, LQGs and SQGs are required to:

- Determine if they have generated a hazardous waste (see Part 262.11);⁵
- Determine if the hazardous waste is “prohibited” from land disposal under the Land Disposal Restrictions (LDR) program (see Part 268). A prohibited waste is a waste that does not meet its applicable LDR treatment standards at its point of generation and cannot be land disposed until it meets those standards. If they have a prohibited waste, they must either treat it on-site to meet the standards, or send it to an off-site treater or recycler along with the required paperwork. A waste analysis plan (WAP) is required for generator on-site treatment to meet LDR treatment levels;
- Manage the hazardous wastes in accordance with the applicable Part 262 and 268 requirements (e.g., accumulate the hazardous wastes only in tanks or containers that meet specified standards, perform periodic inspections); and
- Comply with Part 262 and 268 recordkeeping and reporting requirements (e.g., retain waste analysis data).

The requirements for permitted and interim-status TSDFs can be found primarily in 40 CFR Parts 264 through 268 and 270. Concerning the waste analysis requirements, §§264/265.13 require a TSDF to:

- Properly characterize hazardous wastes before managing them and repeat these analyses as specified (pre-acceptance);
- Inspect incoming shipments that are received at TSDFs from off-site sources for hazardous waste management; and
- Prepare and follow a WAP that adequately describes the methods, procedures and equipment that will be used to perform these analytical requirements.

In addition, the TSDF may be subject to analytical requirements elsewhere in the regulations, depending on the waste management activities that it performs (e.g., LDR treatment, storage of organic waste in containers, feedstream analysis for hazardous waste combustors and thermal treatment units). The WAP must specify the methods that will be used to meet these other analytical requirements (e.g., see 264/265.13(b)(6)).

For additional information on these topics, refer to the references identified in this section. In addition, Envirofacts and RCRAInfo can be used to learn about the RCRA-regulated

⁴ Conditionally exempt small quantity generators (CESQGs) are subject to the regulations at 40 CFR 261.5, including the need to make hazardous waste determinations.

⁵ Unless otherwise specified, “Part” or “Parts” herein are references to parts of Title 40 of the Code of Federal Regulations.

universe (e.g., generators and TSDFs) and the types and quantities of hazardous wastes generated and managed by them.

1.1 Generator and TSDF Waste Analysis Requirements

Following is a summary of some of the analytical and related requirements that apply to generators and TSDFs. See Appendix C of this manual for more detailed information, including the regulatory references, of many of the RCRA waste analysis requirements, to which generators and TSDFs are subject.

1.1.1 Generator Waste Analysis Requirements

Persons who generate a solid waste are obligated under §262.11 to determine if their wastes are hazardous. Also if they intend to send the hazardous waste to a TSDF, the generator may be required to provide waste-related information to the TSDF, such as a waste profile (see Section 1.1.2 on pre-acceptance) or information that accompanies an LDR notice with a shipment (see the Generator Paperwork Requirements Table at 268.7(a)(4)). The TSDF's WAP will specify what information is required. **A generator is required to prepare a WAP only if he is managing and treating waste or contaminated soil in tanks, containers, or containment buildings regulated under 40 CFR 262.34 to meet applicable LDR treatment standards.** Figures 1-1 and 1-2 provide an overview of the RCRA waste analysis and WAP requirements that apply to generators.

As a generator, you must determine if the waste generated is a RCRA hazardous waste, as required by §262.11, by:

- First determining if your waste is excluded from regulation (see the solid and hazardous waste exclusions at §261.4(a) and (b));
- Then determining if it is listed as a hazardous waste in Subpart D of 40 CFR Part 261; and
- For purposes of compliance with LDR Program in Part 268, or if the waste is not listed in Subpart D of Part 261, determining whether the waste exhibits any of the hazardous characteristics in Subpart C of Part 261. You may test the waste or use acceptable knowledge to make the determination. (See Section 1.2.2 for a discussion of some of the types of information that EPA would consider “acceptable” knowledge.) See Appendix A for additional information on hazardous waste identification procedures.

Applicability of WAPs to Generators

A generator is not required to prepare a WAP except when managing and treating waste or contaminated soil in qualified units to meet applicable LDR treatment standards found at §268.40. See §268.7(a)(5) for this requirement.

If you have generated a hazardous waste or acute hazardous waste, you must determine the amount of hazardous waste that you generated during that calendar month, as required by 40 CFR §§261.5. You then must determine whether you are a small quantity generator

(SQG), large quantity generator (LQG), or conditionally exempt small quantity generator (CESQG):⁶

- SQGs (generators of > 100 kg/month and < 1,000 kg/month of hazardous waste) are subject to regulation under Part 262 and other applicable parts (e.g., Part 268).
- LQGs (generators of ≥ 1,000 kg/month of hazardous waste) are subject to regulation under Part 262 and other applicable parts (e.g., Part 268).
- CESQGs (generators of ≤ 100 kg/month of hazardous waste) are subject to limited requirements as specified in §261.5 (e.g., hazardous waste determinations, monthly counting). They are not subject to the waste analysis requirements other than hazardous waste determinations at §261.5(g)(1).

If you are a LQG or SQG, you must determine if your hazardous waste must be treated to meet the LDR treatment standards before being land disposed, as required in §262.11 and Part 268. You must determine each EPA hazardous waste code that applies to your hazardous waste, which allows you to determine the applicable treatment standards under the LDR program. You must refer to the treatment standards in 40 CFR §§268.40, 268.45, and/or 268.49 to determine if your waste “as generated” must be treated. This determination can be made concurrently with the hazardous waste determination described above. You can either test the waste or use acceptable knowledge of the waste. Alternatively, you can send the waste to a hazardous waste treatment facility subject to a RCRA permit, where the facility can make the LDR determinations in accordance with 40 CFR §§264.13, 265.13, and 268.7(b).

If the hazardous waste does not meet the treatment standards, it must be treated before being land disposed. Some wastes must be treated by a particular treatment method before land disposal while other wastes are subject to concentration-based treatment standards.

In addition, if you are a LQG, you must comply with the organic air emission standards in Subparts AA, BB, and CC of Part 265, including a requirement to test the waste or use acceptable knowledge of the waste to determine if the air emission requirements apply to your units.

⁶ The quantities below only apply to hazardous waste. For acute hazardous waste quantities, see 40 CFR 261.5(e).

FIGURE 1-1: Summary of Generator Analytical Requirements ^a

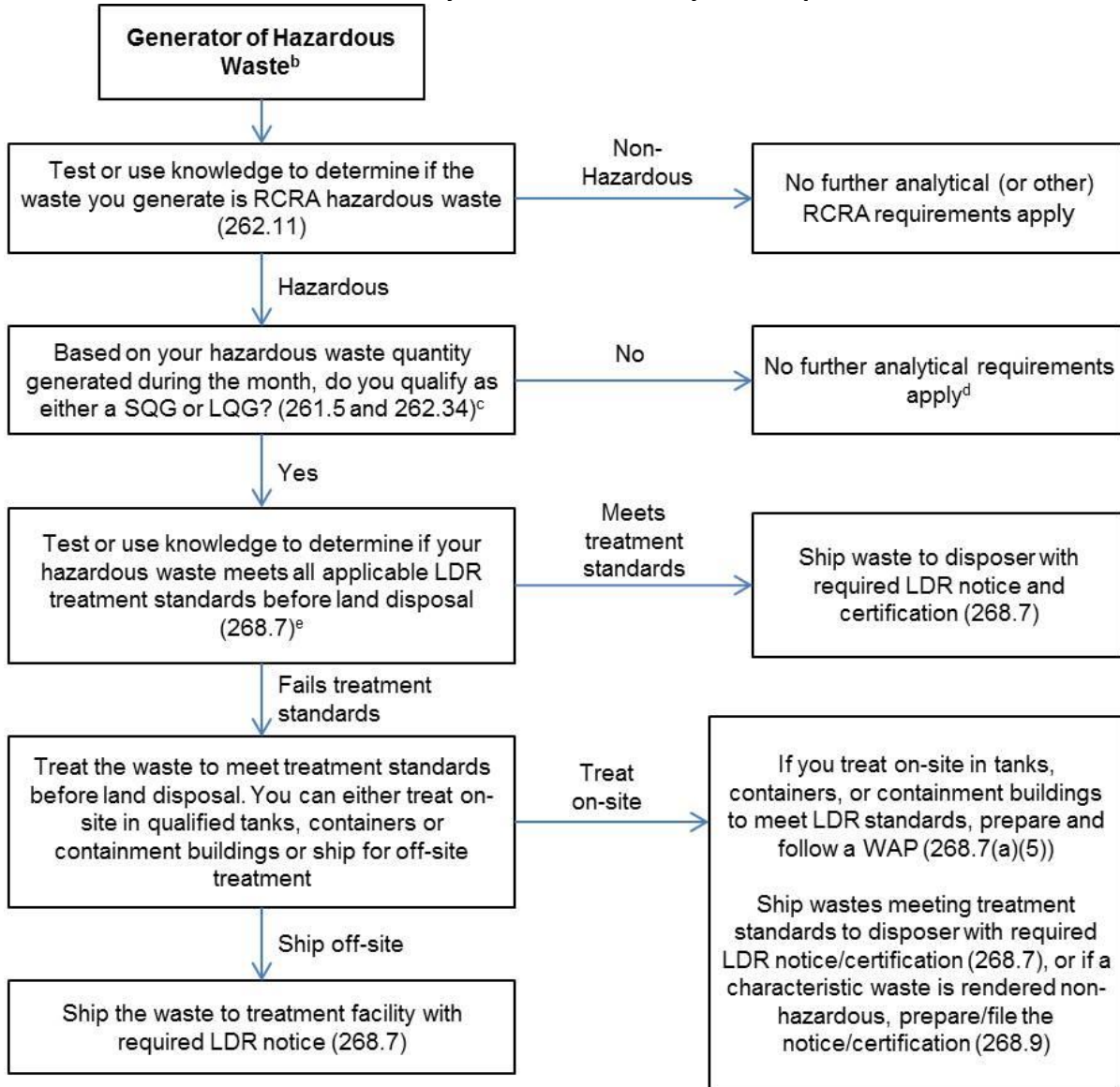

Footnotes

- a. This figure presents federal RCRA hazardous waste requirements. You should consult your state's regulations to learn the requirements that apply to you. This figure does not necessarily identify all analytical requirements to which a generator may be subject. See Figure 1-2 for additional analysis requirements for LQGs.
- b. A "generator" is any person, by site, whose act or process produces hazardous waste or whose act first causes a hazardous waste to become subject to regulation.
- c. 40 CFR 261.5 and 262.34 establish standards for making waste quantity determinations and determining generator status. Small quantity generators (SQGs) and large quantity generators (LQGs) must comply with applicable generator standards in Part 262 and Part 268, including the waste analysis requirements described in this figure.
- d. If you are a conditionally exempt small quantity generator (CESQG), you must comply with the requirements in section 261.5; however, no additional waste analysis is required.
- e. This determination is usually made concurrently with the hazardous waste determination. Alternatively, the generator can send the waste to a treater to make the LDR determinations.

FIGURE 1-2: Analytical Requirements for LQGs under Subparts AA, BB, and CC of 40 CFR Part 265 ^a

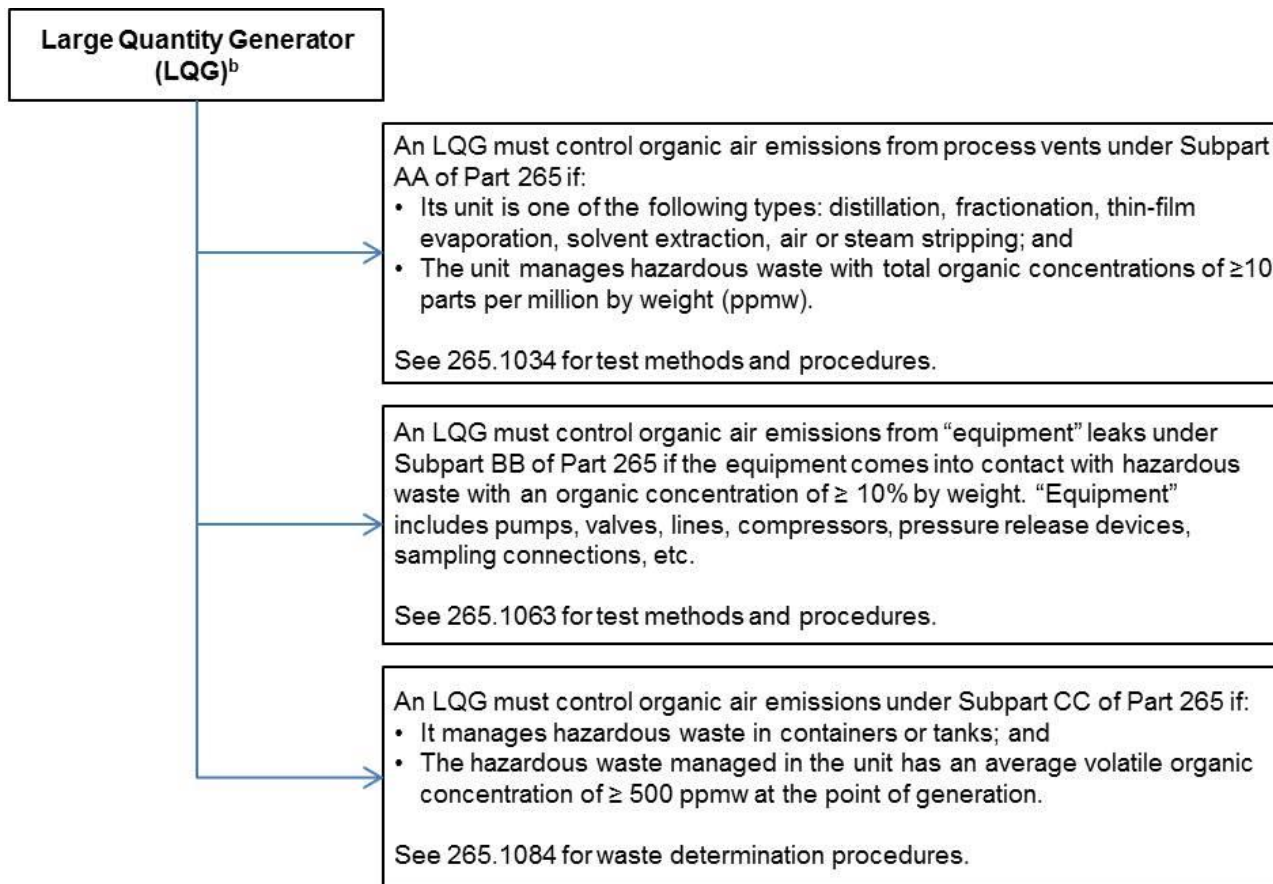

Footnotes

- a. This figure presents federal RCRA hazardous waste requirements for large quantity generators (LQGs) under the organic air emission standards. You should consult your state's regulations to learn the requirements that apply to you. See Figure 1-1 for additional waste analysis requirements for generators.
- b. 40 CFR 261.5 and 262.34 establish standards for making waste quantity determinations and determining generator status. Small quantity generators (SQGs) and large quantity generators (LQGs) must comply with applicable generator standards in Part 262 and Part 268. Section 262.34(a) requires LQGs to comply with Subparts AA, BB and CC of Part 265, among other things. Each subpart also includes applicability criteria.

1.1.1.1 LDRs: UHCs

If you determine that your waste exhibits a hazardous waste characteristic, you must also determine whether the hazardous waste contains underlying hazardous constituents (UHCs) (there are no UHCs for listed waste). A UHC is any constituent listed in 40 CFR §268.48, Table UTS—Universal Treatment Standards, except fluoride, selenium, sulfides, vanadium, and zinc, which can **reasonably be expected** to be present at the point of generation of the hazardous waste at a concentration above the constituent-specific UTS treatment standards (§268.2). To determine whether you need to be concerned about UHCs in your waste, go to the Table -- Treatment Standards for Hazardous Wastes in §268.40. The table shows, for example, that a D001 non-wastewater exhibiting the ignitability characteristic, except for the High TOC subcategory, has a treatment standard expressed as “DEACT and meet §268.48 standards; or RORGs; or CMBST.” This means that, if you choose to treat it using deactivation, you (or the treater receiving your hazardous waste) must determine what the UHCs are in your hazardous waste. Then, you can go to the UTS table in 40 CFR §268.48, which lists the UHCs and their respective treatment standards expressed as a concentration. The waste must be treated to both eliminate the characteristic(s) **and** meet the UTS treatment standards for the UHCs, as indicated in the UTS table. Compliance with the treatment standards in the UTS table is measured by an analysis of grab samples, unless otherwise noted in the table.

Applicability of UHCs to Treatment Residuals

Generators of characteristic hazardous wastes are required to identify any underlying hazardous constituents reasonably expected to be present above their concentration-based levels (see Table in 268.48) at the point of generation. This means that metal constituents that did not qualify as UHCs in the original waste, but are concentrated to above UTS levels during treatment, treaters are not expressly required to further treat the residuals such that those metal constituents meet UTS levels. If, however, the residual exhibits a characteristic due to a new property (e.g., concentrated metals now exceed one or more of the constituent-specific Toxicity Characteristic thresholds), residuals exiting the treatment unit would be considered a new point of generation, the treater would be considered to be the generator, and the full suite of UHCs must be reconsidered and identified, as appropriate. See [64 FR 25411 \(May 11, 1999\)](#) for additional clarification.

1.1.1.2 LDRs: WAP Requirement

If you are a generator managing and treating prohibited waste or contaminated soil in tanks, containers, or containment buildings regulated under 40 CFR §262.34 to meet applicable LDR treatment standards, you must prepare and follow a WAP [40 CFR 268.7(a)(5)]. The WAP must describe the procedures you will carry out to comply with the treatment standards. (Generators treating hazardous debris under the alternative treatment standards of Table 1, 40 CFR §268.45, however, are not subject to these waste analysis requirements.) The plan must be kept on site in your records for review by inspectors, and the following requirements must be met:

- The WAP must be based on a detailed chemical and physical analysis of a representative sample of the prohibited waste(s) being treated, and contain all information necessary

to treat the waste(s) in accordance with the requirements of Part 268, including the minimum selected testing frequency.

- Wastes shipped off-site must comply with the notification requirements of 40 CFR §268.7(a)(3).

1.1.2 TSDF Waste Analysis Requirements

As a TSDF, you must comply with the applicable §264.13 and/or 265.13 requirements for waste analysis and WAPs. Part 264 generally covers the requirements for permitted facilities/regulated units, whereas Part 265 covers interim status facilities/units. Figure 1-3 provides an overview of these requirements. The figure identifies the requirement for a WAP at 264.13 and 265.13, as well as the analytical requirements, found elsewhere in the RCRA regulations that must be addressed in the WAP (e.g., the Part 268 requirements for treaters and disposers to test treated waste for LDR compliance).⁷

The TSDF may use generator-supplied information to aid in its understanding of the waste it receives and manages. However, the TSDF is ultimately responsible for understanding the wastes to ensure compliance with its permit/regulations and manage the wastes in a safe and protective manner. If the TSDF relies on generator-supplied information, it is important to review and verify this information to ensure its adequacy (e.g., by performing fingerprint analyses to determine if a shipment matches the manifest).

TSDF Analytical Responsibilities

40 CFR §§264/265.13(a) establish two broad analytical responsibilities that you as a TSDF must perform at a minimum:

- Pre-acceptance.** Before you can treat, store, or dispose of hazardous candidate waste, you must obtain a detailed chemical and physical analysis of a representative sample of the waste. At a minimum, the analysis must contain all the information which must be known to properly treat, store, or dispose of the waste in accordance with 40 CFR Part 264 or 265 and the LDR program. The analysis may include information developed under 40 CFR Part 261, and existing published or documented data on the hazardous waste or on hazardous waste generated from similar processes. For example, studies conducted on hazardous waste generated from similar processes as the waste to be managed at the facility may be included in the analysis, as specified. The owner or operator of an off-site facility may arrange for the generator of the hazardous waste to supply part of the information required, except as otherwise specified in 40 CFR §§268.7(b) and (c). **If the generator does not supply the information or supplies incomplete or inadequate information, and the owner or operator chooses to accept a hazardous waste, the owner or operator is responsible for obtaining the information required for compliance.**

⁷ The figure does not address all analytical requirements that may potentially apply to a TSDF.

The analysis must be repeated as necessary to ensure that it is accurate and up to date. As with the initial analysis, the owner or operator of an off-site TSDF may arrange for the generator of the hazardous waste to supply part of the information required. At a minimum, the analysis must be repeated:

- When the owner or operator is notified, or has reason to believe, that the process or operation generating the hazardous wastes, or non-hazardous wastes if applicable under 40 CFR §264/265.113(d), has changed; and
 - For off-site facilities, when the evaluation of incoming shipments, described below, indicates that the waste received at the facility does not match the waste designated on the accompanying manifest or shipping paper.
- **Waste acceptance.** If you are the owner or operator of an off-site facility, you must inspect and, if necessary, analyze each hazardous waste shipment received at the facility to determine whether it matches the identity of the waste specified on the accompanying manifest or shipping paper.

Contents of WAP

40 CFR §§264/265.13(b) and (c) spell out the information that must be included in your WAP in order to perform the analyses described in the text above, as well as other analyses that may be needed at your facility:

- The parameters for which each hazardous waste, or non-hazardous waste if applicable under 40 CFR §§264/265.113(d), will be analyzed and the rationale for the selection of these parameters (i.e., how analysis of these parameters will provide sufficient information of the waste's properties as specified).
- The test methods that will be used to test/analyze these parameters.
- The sampling method that will be used to obtain a representative sample of the waste to be analyzed. A representative sample may be obtained using either:
 - Appropriate sampling method in Appendix I of 40 CFR Part 261 for the waste; or
 - An equivalent sampling method.
- The minimum frequency with which the initial analysis of the waste will be reviewed or repeated to ensure that the analysis is accurate, up to date, and representative of the waste over time.
- For off-site facilities, the waste analyses that hazardous waste generators have agreed to supply.
- For permitted TSDFs, where applicable: the methods that will be used to meet the additional waste analysis requirements for specific waste management methods as specified in 40 CFR §§264.17, 264.314, 264.341, 264.1034(d), 264.1063(d), 264.1083, and 268.7. (See Figure 1-3.)

- For interim-status TSDFs, where applicable: the methods that will be used to meet the additional waste analysis requirements for specific waste management methods as specified in 40 CFR §§265.200, 265.225, 265.252, 265.273, 265.314, 265.341, 265.375, 265.402, 265.1034(d), 265.1063(d), 265.1084, and 268.7. (See Figure 1-3.)
- For surface impoundments exempted from the land disposal restrictions under 40 CFR §268.4(a), the procedures and schedules described in 40 CFR §264/265.13(b)(7).
- For owners and operators seeking an exemption to the air emission standards of Subpart CC in accordance with 40 CFR §264.1082 or 265.1083, the information specified in 40 CFR §§264/265.13(b)(8).
- For off-site facilities, the procedures that will be used to inspect and, if necessary, analyze each movement of hazardous waste received at the facility to ensure that it matches the identity of the waste designated on the accompanying manifest or shipping paper. At a minimum, the plan must describe:
 - The procedures that will be used to determine the identity of each waste managed at the facility.
 - The sampling method that will be used to obtain a representative sample of the waste to be identified, if the identification method includes sampling.

The procedures that the owner or operator of an off-site landfill receiving containerized hazardous waste will use to determine whether a hazardous waste generator or treater has added a biodegradable sorbent to the waste container.

FIGURE 1-3: Summary of TSDF Analytical Requirements ^a

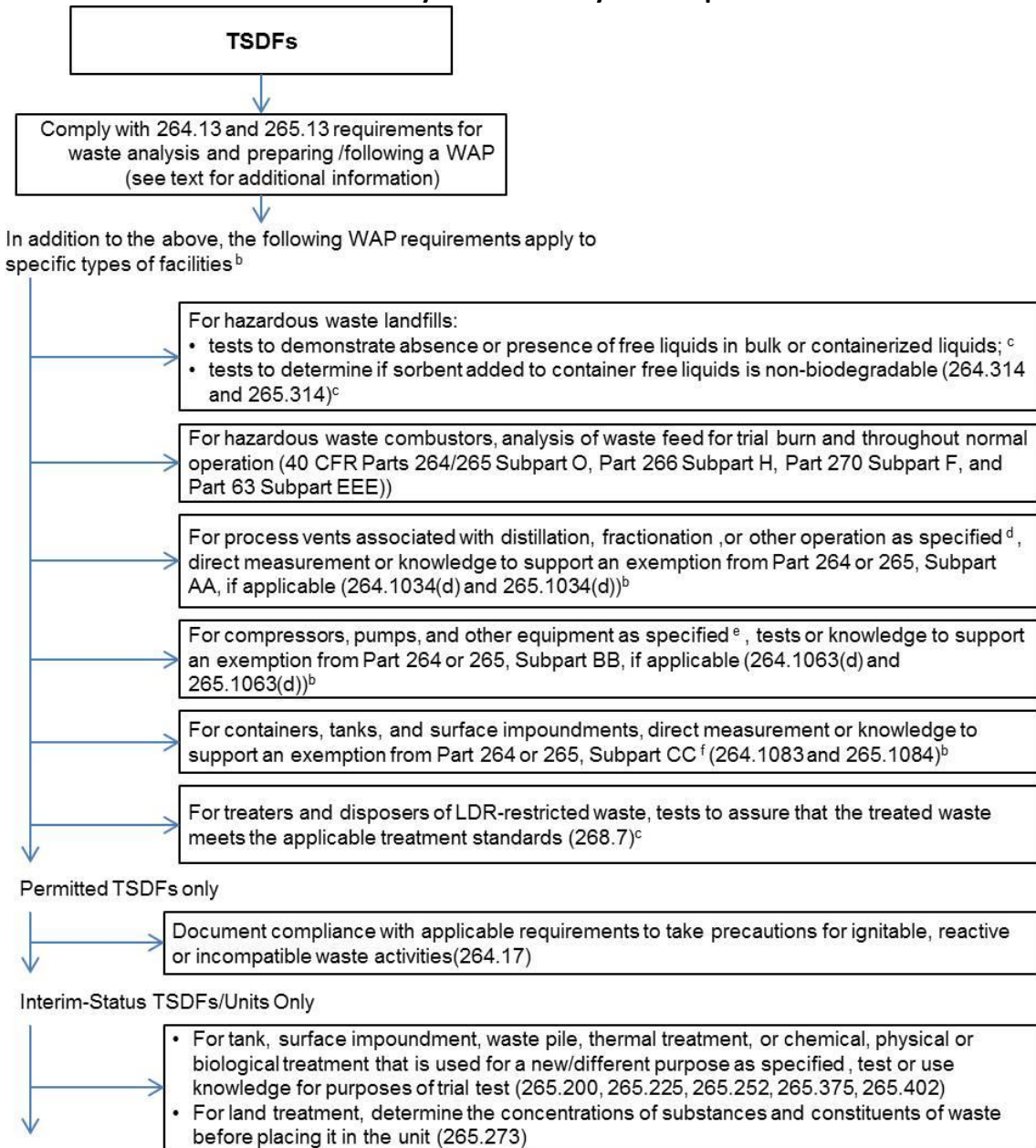

Footnotes

- a. This figure presents federal RCRA hazardous waste requirements. You should consult your state's regulations to learn the requirements that apply to you. This figure does not address all analytical requirements that may potentially apply to a TSDF. It only addresses the §264.13 and 265.13 requirement for a WAP, the analytical requirements identified in §264.13(b)(6) and 265.13(b)(6), and combustor requirements (e.g., Part 266).
- b. LQGs also are subject to Part 265, Subparts AA, BB and CC, as specified.
- c. Testing (and not knowledge) is required or specified in the regulations. See §268.7(b)(1)-(2) and 268.7(c)(2).
- d. Distillation, fractionation, thin-film evaporation, solvent extraction, or air or steam stripping operations that manage hazardous waste with organic concentrations ≥ 10 ppmw are subject to Part 264 or 265, Subpart AA.
- e. Compressors, pumps, and other equipment as specified that contain or contact hazardous waste with organic concentration $\geq 10\%$ by weight may be subject to Subpart BB. Consult 40 CFR §254/265 for exemptions to and other information regarding Subpart BB.
- f. Subpart CC applies to containers, tanks and surface impoundments with waste having an average volatile organic (VO) concentration at the point of waste origination of ≥ 500 parts ppmw.

1.1.3 Transmitting Waste Analysis Information

In addition to conducting waste analyses and developing/following a WAP, a generator (or owner/operator of a TSDF making an offsite shipment) must provide waste analysis information to the TSDF that subsequently receives the waste, as specified [40 CFR §268.7]. For example, if you are:

- A generator of a hazardous waste who sends waste off-site for treatment, storage, or disposal, you must provide to the TSDF the waste analysis information, the applicable RCRA codes, and the applicable LDR treatment standards. It is recommended that the generator also provide the TSDF with a description of the process that generated the waste. The information will help ensure, among other things, that your waste can be accepted according to the facility permit. [See 40 CFR §264/265.13(a) and §268.7(a)] Refer to the Generator Paperwork Requirements Table at §268.7(a) to see the information required on LDR notifications and certifications.
- Adding Waste Codes to an LDR Notification (§268.7(a))**

An Example

A waste stream, K062, is listed due to corrosivity, hexavalent chromium and lead. The LDR treatment standard for K062 only includes treatment for metals. If the K062 waste stream is actually corrosive, the LDR notification form will need to include the waste codes K062 **and** D002 so the treatment facility knows to treat the waste for corrosivity also.
- An owner/operator of a treatment facility, you must provide waste analysis information (including any information supplied by the generator, as well as waste analysis data developed by your facility before and after treatment) to any off-site storage or disposal facility receiving the waste to ensure that the waste is managed in compliance with LDR requirements and their permit. [See 40 CFR §264.13(a) and §268.7(b)] Refer to the Treatment Facility Paperwork Requirements Table at §268.7(b) to see the information required on LDR notifications and certifications.
 - Generators and TSDFs are required to transmit waste-related information to facilities receiving their wastes under the manifest and LDR programs. A helpful summary of information-sharing requirements under the LDR program can be found in the “Generator Paperwork Requirements Table” [40 CFR §268.7(a)] and “Treatment Facility Paperwork Requirements Table” [40 CFR §268.7(b)].

Information-Sharing under Manifest and LDR Programs

Manifest Program

- For generators, refer to Subpart B of 40 CFR Part 262
- For TSDFs, refer to Subpart E of 40 CFR Part 264 or Part 265

LDR Program

- For generators, treaters, and disposers, refer to 40 CFR 268.7

In addition to generators and TSDFs, waste transporters and waste transfer facilities also have hazardous waste-related responsibilities, as specified in Part 263. These facilities are generally not required to conduct waste analyses. However, to ensure safe handling, transporters and transfer facility owner/operators need to know the identity of the wastes they are handling. They generally rely on the information provided by the generator or the

TSDF offering the waste for transport as presented on the hazardous waste manifest. Therefore, the accuracy and completeness of the waste analysis performed by the generators and TSDFs is important to them and to the many individuals (e.g., subsequent transporters, emergency response personnel) who may encounter these materials while they are in transit.

Figure 1-4 depicts the transfer of waste analysis information that needs to occur among facilities that are shipping and receiving waste. It is advantageous for all facilities involved to provide detailed waste analysis information with each shipment of a waste stream, and for the receiving facility to verify, through waste analysis, the information that the generator or sender of the waste provided. Doing this should increase the likelihood that the waste will be treated, stored, or disposed of properly, and reduce the chance of accidents, releases, and mismanagement.

FIGURE 1-4: Waste Analysis Data Flow

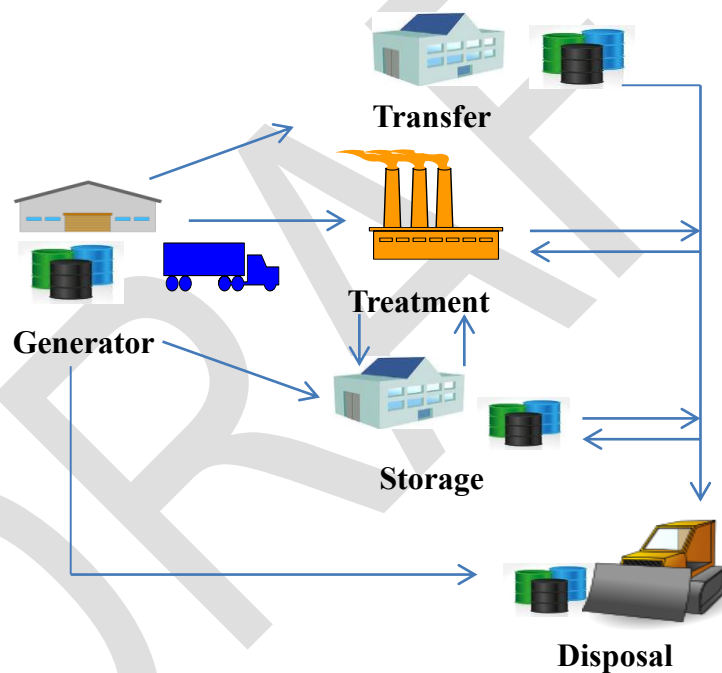

1.2 How Can You Meet The Waste Analysis Requirements For Your Facility?

You can meet the general and specific waste analysis requirements using several approaches or combinations of methods. Meeting waste analysis requirements by performing waste sampling and laboratory testing typically is more accurate, precise, and defensible than other options. (The procedures and equipment for both obtaining and analyzing samples are discussed in Part Two of this manual. In addition, see Appendix I of 40 CFR Part 261 for sampling methods.) Section 1.2.1 addresses sampling and analysis.

Waste analysis information can be acquired by either collecting samples and conducting laboratory testing or using published data and generator knowledge of the waste generating process (known as acceptable knowledge, generator knowledge or process knowledge). Acceptable knowledge can include, but is not limited to:⁸

- Process knowledge, whereby detailed information on the wastes is obtained from existing published or documented waste analysis data or studies conducted on hazardous wastes generated by processes similar to that which generated the waste (process knowledge is supported with technical data);
- Data from analysis or testing performed by the generator; or
- In cases of newly listed wastes, data from recent waste analyses performed prior to the effective date of the listings.

Generators may use any of these in making hazardous waste determinations. TSDFs may have process-related permit requirements that exceed generator determinations. The regulations establish more robust waste analysis requirements for TSDFs. At all times, the owner/operator of a TSDF is responsible for obtaining sufficient information required for compliance, regardless of the completeness or quality of any information received from the generator or other parties. Although it may not meet all TSDF analysis requirements, acceptable knowledge, as discussed above, may be sufficient for documenting compliance in certain circumstances, and is required to be used where no regulatory test defining compliance exists (e.g., D003). If the regulatory agency determines that a TSDF's use of acceptable knowledge is deficient, the agency can require the TSDF to take additional steps to address such deficiencies.

Many factors influence the determination of WAP requirements. Some permit conditions require compliance with precise numerical values. Other conditions can be met with less sophisticated testing or simple direct visual inspection. Wastes and their matrices can be highly variable even within a single shipment. Other waste shipments may be more homogenous, but may have higher variability over time, perhaps reflecting seasonal or market-based variations in the process generating the waste. All of these factors should be evaluated for each waste in developing an appropriate waste analysis plan. Figure 1-5 shows how these factors may influence the quality and quantity of waste analysis that may be needed for different permit conditions.

⁸ For additional discussion of acceptable knowledge, see 58 FR 48111 (September 14, 1993), [59 FR 62916 \(December 6, 1994\)](#), and [62 FR 62081 \(November 20, 1997\)](#).

FIGURE 1-5: Waste Analysis Quality – Conceptual Model

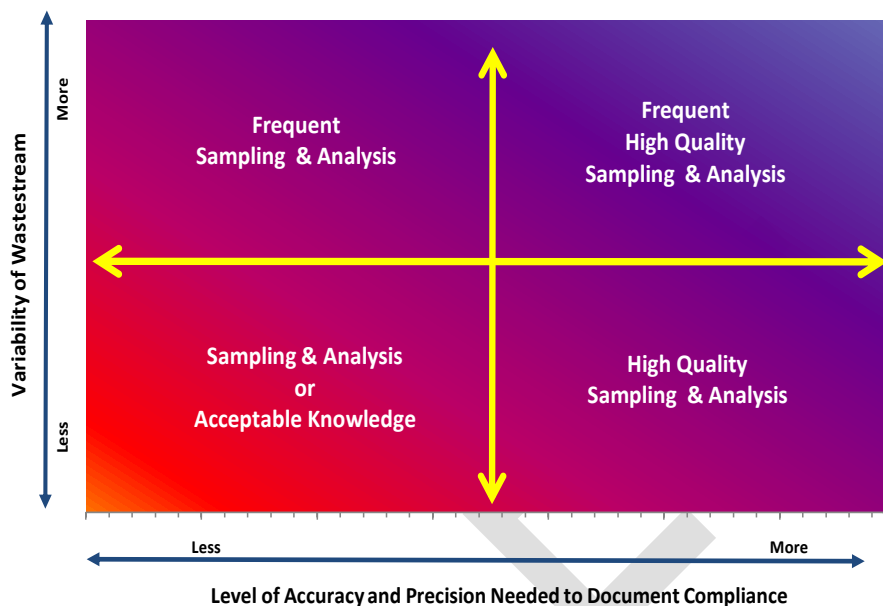

For example, facilities with constituent feedrate limits may need relatively accurate and precise analytic results to verify that concentrations fall within an acceptable range to document compliance (such as heavy metal feedrates in support of a risk-based permit limit for a hazardous waste combustor or for compliance with the Maximum Achievable Control Technology (MACT) standards of the Clean Air Act where the WAP includes elements of the MACT-Feedstream Analysis Plan). Waste streams comprising a variety of materials, such as a catchall “contaminated debris” wastes (e.g., process waste mixed with personal protective equipment, sample jars, etc.) may require frequent analysis to document compliance, whereas acceptance screening of corrosive wastes may only require occasional testing with simple test strips. Waste streams shown to be consistent over time may only require periodic evaluation and/or testing.

1.2.1 Sampling and Analysis for TSDFs

Sampling and analysis can be used to meet all waste analysis requirements for a TSDF. Frequent and higher quality sampling and analysis, such as analyzing the waste for a broader list of constituents with laboratory instrumentation, may be necessary when:

- A generator begins a new process or changes an existing process;
- Wastes are received by a facility for the first time;
- A generator has not provided appropriate laboratory information to the TSDF;

- The TSDF has reason to believe that the wastes shipped were not accurately identified by the generator; or
- EPA changes RCRA waste identification/classification rules.

Sampling and analysis can be used to document compliance for pre-acceptance, waste acceptance, and other on-site waste management activities. These are described below.

Pre-Acceptance Sampling and Analysis

A TSDF may need to confirm various characteristics of a waste at the time of pre-acceptance (profiling) to avoid accepting a generator's waste which they are not permitted to handle. Sampling and analysis may be essential for certain types of wastes and/or operations conducted at the facility, e.g., if the TSDF's treatment/disposal processes must meet numerical limits.

The analytical data can be submitted along with a "waste profile sheet (WPS)" or Waste Characterization Report ("WCR") and other supporting data to the TSDF to describe the generator's waste. An example of a waste profile sheet is provided in Figure 2-9 of this manual. Waste profiles and submitted data should be used by the TSDF, pursuant to §§264/265.13(a), to (1) know what waste they will be managing and (2) ensure that the incoming waste received matches the waste the facility originally approved, which best assures that they are allowed to manage such waste in accordance with their permit and/or regulations.

Considerations for TSDF Pre-Acceptance Procedures

- Specifying circumstances in which generic profiles can/cannot be used so they are not inappropriately used, if applicable. For purposes of this manual, a generic profile (also called a "standard profile") is defined as a profile that could be used for multiple waste streams that are similar in physical and chemical characteristics. Generic profiles generally may not be acceptable if the TSDF's treatment/disposal processes must meet numerical limits.
- Sampling wastes during pre-acceptance under certain circumstances, e.g., if the TSDF's treatment/disposal processes must meet numerical limits.
- Establishing a recurring process for re-evaluating waste profiles or sending waste profiles to generators periodically or as required by state regulation for their review, update, and certification to determine that profiles are up to date.
- Carefully examining documentation from the generator supporting its waste profile sheet (e.g., see the suggested factors in Section 1.2.2 for evaluating acceptable knowledge).

Waste Acceptance (Fingerprint Analysis)

Waste acceptance sampling and analysis can include rigorous laboratory instrumental analysis, testing with field test kits and screening instruments, or by making qualitative observations such as visual identification of color, number of phases, etc. The specific information needed for waste acceptance may depend on the variability of the waste, the

accuracy and precision needed to comply with permit requirements, and the stated objectives of waste acceptance.

One objective of all waste acceptance sampling and analysis is to confirm the waste received is the same as the waste expected. Visual identification of color and number of phases are examples of fingerprint analysis that can be used to help verify that the waste generated (or received by an off-site TSDF) matches the expected characteristics for that waste. Other examples of this type of screening include specific gravity, flash point, BTU/lb, pH, halogen content, cyanide content, and percent water. For certain types of wastes, verifying the packaging form and packaging content of the waste would also be an important waste acceptance activity.

Fingerprint analysis parameters specified in a WAP to verify that each waste arriving at the gate of the TSDF is the actual waste expected are often quick screening tests or observations since the detailed chemical and physical properties of a waste are usually obtained under pre-acceptance sampling and analysis, subsequent sampling and analysis at the TSDF, or from acceptable knowledge. Fingerprint parameters and the criteria for acceptance/rejection of the waste will be discussed in Part Two of this manual.

Another example of a waste acceptance objective is the need to track metal concentrations in a highly variable waste stream to document compliance with permitted feedrates. This type of acceptance sampling could require sophisticated analysis using laboratory methods.

Although key parameters can be used to obtain a representation of waste composition quickly, owner/operators should be aware that EPA will generally measure compliance with the hazardous waste regulations based on a detailed chemical and physical analysis of a

Considerations for TSDF Acceptance Procedures

- Fingerprinting $\geq 10\%$ of the containers of each waste stream shipped from each generator.
- Using a tiered approach for analyzing incoming shipments, whereby all shipments are inspected/fingerprinted and non-conformances between shipment and waste profile sheet (WPS) trigger a mandatory evaluation to resolve it and update the WPS (or create a new one) if needed.
- Documenting tolerance limits for at least one fingerprint parameter based on the operating requirements of the facility's management systems, such as a ± 2 pH unit difference between the shipment and that of the pH in the profile. If the pH of an incoming shipment falls outside this range, the value would be considered a non-conformance that should be evaluated and may be subsequently rejected or requalified as appropriate.
- Visually inspecting lab packs as a potentially acceptable alternative to fingerprinting them when safe to do so (e.g., open the containers and verify their contents and packing materials) and reviewing their inventories (e.g., for incompatibility of materials).
- Ensuring that a detailed analysis for the waste constituents regulated under the LDRs is completed at least annually by the generator or treater (e.g., to verify that treated wastes do, in fact, meet applicable LDR treatment standards). See EPA interpretive guidance, "Waste Analysis Requirements in Incoming Waste Shipments –LDR," which is available at RCRA Online ([Number 12943](#)).
- Using a random sampling approach for incoming shipments, whereby the TSDF takes a representative sample from a small percentage of incoming waste shipments and performs a comprehensive chemical analysis to verify LDR compliance.

representative sample of the waste(s) in question. As a result, it is important for the selection of key parameters to be based on sufficient waste profile knowledge and data testing frequency to ensure accurate waste representation.

Other Information Needed for TSDF On-site Management

Other information may be needed to document compliance with permit conditions, but may not be needed for pre-acceptance or acceptance sampling and can be obtained from sampling and analysis at the TSDF. An example includes verification of treatment objectives as a result of permitted treatment or destruction. Sampling and analysis may be particularly important for wastes that could affect the site's ability to achieve numerical limits (e.g., feed rates for combustors, organic constituent levels for wastes subject to the organic air emission standards in 40 CFR Subparts AA through CC of Part 264 and 265).

1.2.2 Acceptable Knowledge and TSDFs

While waste generators are responsible for making accurate hazardous waste classifications using procedures described in 40 CFR 262.11, TSDFs are not relieved of their responsibility to obtain accurate waste analysis data despite the submission of information provided to the TSDF by generators. Acceptable knowledge can be used to provide information for pre-acceptance (profiling) needs, as well as information needed to comply with permit requirements. However, acceptable knowledge may not be an appropriate substitute for fingerprint or spot check procedures except in unique cases such as when the TSDF is accepting properly manifested waste from another site owned by the same company. As mentioned previously, there may be situations where it may be sufficient to apply acceptable knowledge, such as where:

- Determining hazardous constituents in wastes from specific processes that are well documented, such as with the F-listed and K-listed wastes, *presuming that the wastes are not highly variable and accurate and precise concentrations are not necessary for documenting compliance.*
- Wastes are discarded unused commercial chemical products, reagents or chemicals of known physical and chemical constituents, *presuming that the wastes are not highly variable and accurate and precise concentrations are not necessary for documenting compliance.* See the P- and U-listed waste categories in 40 CFR §261.33.
- Evaluating waste against the hazardous characteristics for which there is no defining test (e.g., ignitable solids, oxidizers, reactive when wet, etc.)
- Health and safety risks to personnel would not justify sampling and analysis (e.g., radioactive mixed waste).
- Physical nature of the waste prohibits taking a laboratory sample. For example, to conduct waste analysis of surface-contaminated construction debris, such as steel girders, piping, and linoleum, it may be necessary to use a combination of laboratory analysis and acceptable knowledge. The acceptable knowledge would be applied to identifying the composition of

the base construction materials (e.g., steel). One could then collect surface “wipe” samples and conduct laboratory analysis to determine the representative concentrations of any contaminants present. If the base materials are porous, such as gypsum, the contamination could be determined by conducting analysis on the extracts obtained from a solvent wash.

When using acceptable knowledge, documentation is important for presenting the information used as the basis for the owner’s or operator’s classification of the hazardous waste. Examples of information that may be used as part of the basis for acceptable knowledge include: material balances for the source or process generating the hazardous waste; constituent-specific chemical test data for the hazardous waste from previous testing that are still applicable to the current waste; previous test data for other locations managing the same type of waste; or other knowledge based on information included in manifests, shipping papers, waste certification notices, and Safety Data Sheets (SDSs, formerly known as MSDSs).⁹

Suggested Factors for Evaluating Waste Determinations Using Acceptable Knowledge (AK)

- ✓ Is published data as current as practicable (e.g., SDSs greater than five years old may be obsolete due to changes in RCRA program, improvements in testing protocols, etc.)?
- ✓ Do material balances, if used, include the following (among other things):
 - Raw ingredient descriptions and physical and chemical properties
 - Physical and chemical processes involved prior to and during generation
 - Intermediate products
 - Materials added and removed during the process?
- ✓ Does the generator review its original AK determination annually, randomly, and whenever the generating process/waste changes or the TSDF finds a nonconformance?
- ✓ Does the generator understand the potential for changes in the waste and its classification due to environmental factors or spontaneous changes (e.g., separation of organic solvents from a water phase over time, pH changes in contact with ambient air, etc.)?
- ✓ Are records kept demonstrating that periodic reviews are being conducted (e.g., a log or certification by facility personnel that is signed annually)?
- ✓ Are analytical results of published studies based on currently acceptable sample/test methods?
- ✓ Are there significant differences between the published studies and the site’s generation processes/wastes (e.g., raw materials used in the generation process) to warrant concerns about relevancy?
- ✓ Has the TSDF visited the generator’s site to confirm determination?
- ✓ Has the TSDF obtained samples of generator’s waste to verify the accuracy of the generator’s determination?
- ✓ Is the testing capable of illustrating the properties of the waste that are related to the hazardous characteristics?

⁹ The Hazard Communication Standard (HCS) (29 CFR 1910.1200(g)), revised in 2012, requires that the chemical manufacturer, distributor, or importer provide Safety Data Sheets (SDSs) (formerly MSDSs or Material Safety Data Sheets) for each hazardous chemical to downstream users to communicate information on these hazards. The information contained in the SDS is largely the same as the MSDS, except now the SDSs are required to be presented in a consistent 16-section format. Refer to the OSHA web site for additional information (www.osha.gov).

Concerns When Using Acceptable Knowledge

There are several concerns that should be considered when using acceptable knowledge for waste analysis purposes. First, if you own or operate an off-site TSDf and rely on information supplied by a generator, it is important to understand, to the extent possible, the process that generated the waste and ensure the integrity of the information. Second, it is important to scrutinize whether there are any differences between the waste generation process and the process described in the published information/data being utilized and whether the published information/data being used are current.

Generators and off-site TSDf's may use the factors discussed in this section as a starting point to make hazardous waste determinations based on acceptable knowledge. Periodic re-evaluation of hazardous waste determinations may be necessary because EPA periodically revises the criteria that qualify a waste as a hazardous waste, or the waste properties may change over time due to handling practices or exposure to the environment. Therefore, if you use acceptable knowledge, you may need to review your waste analysis or waste characterization information periodically to verify that the hazardous waste determinations you have made are still accurate. In addition, you may need to determine if your existing information is sufficient to identify any new constituent concentration limitations (i.e., demonstrate compliance with LDR requirements).

SDSs (aka MSDSs) for chemicals used in the process that generated the waste can be useful in identifying the properties of constituents in the waste; however, it is not recommended that they be relied on to exclude possible contaminants. Contaminants may be introduced as a result of the use of the product and would not be identified on the SDS. SDSs typically list constituents present at a minimum of 1% by mass (10,000 mg/kg). Waste constituent concentrations much lower than this routinely impact hazardous waste management and waste analysis requirements.

The following examples highlight a potential concern with using acceptable knowledge:

- A paint manufacturer used acceptable knowledge to identify the hazardous waste constituents of six paint colors. During an EPA inspection, the company produced the documents used to make the hazardous waste determinations that had been generated years earlier. It was based on a test method that was now obsolete. EPA noted that the company now manufactured eight colors. Through testing, EPA discovered that one of the new paints required barium as a coloring agent. Barium is a metal that can cause a waste to exhibit the hazardous waste characteristic of toxicity if found in concentrations exceeding the regulatory level per 40 CFR §261.24. This manufacturer was found to be out of compliance because the level of barium was greater than the maximum concentration for the toxicity characteristic, and the manufacturer's waste analysis data was inaccurate.

- Corrosive solids are not included in the corrosivity definition and so are not hazardous wastes. If such material is managed outdoors and is contacted by rainfall, the rainfall runoff from the waste doesn't create a federally regulated hazardous waste even though the mixture could exhibit the corrosive characteristic.
- If the results of non-regulatory tests are used as part of the basis for applying acceptable knowledge in making a hazardous waste determination, then the testing must be relevant to the hazardous waste characteristic being considered for the waste. While such testing may be useful in illustrating the properties of the waste, since they are not part of the RCRA regulations, they cannot be the sole basis for determining waste non-hazardous status.

Tips on Using a Safety Data Sheet (formerly Material Safety Data Sheets) to Support Waste Determinations

- Some wastes have their own corresponding safety data sheets (SDSs). Often, SDSs are used to support hazardous waste classifications for ingredients used in the process generating the waste. In this instance, SDSs might not represent waste characteristics but are useful in identifying possible waste constituents.
- The two **essential** steps when using an SDS:
 - Confirm that you have selected the correct SDS for your waste or process ingredients (this is a common mistake), and
 - Check the date to confirm it is recent (e.g., more than five years old may be obsolete due to regulatory changes, improvements in analytical methods, etc.).
- Scan the SDS and look for mention of RCRA. The SDS may indicate if the material is a RCRA hazardous waste when discarded.
- If it does not mention RCRA, find the chemical abstract (CAS) number. Check to see if the CAS number is identified in the lists in Subpart D of Part 261. If so, it may be a listed waste when discarded (assuming it is a solid waste and no other exemptions/exclusions apply).
- If it is not listed, it may still be RCRA characteristic. Refer to relevant information on chemical and physical properties for each characteristic, e.g.
 - For ignitability, refer to flashpoint, fire point, etc. Also look at the NFPA fire rating (a rating of 0 or 1 indicates not ignitable, whereas a 3 and 4 would be indicative of ignitability).
 - For corrosivity, refer to pH.
 - For reactivity, refer to the section on reactivity.
 - For toxicity, refer to the constituents in the material, if shown. If none of them are listed under 261.24 Table 1 **and** the purity is high, then this may indicate it does not exhibit toxicity characteristic. However, this requires thorough knowledge of the chemicals in a mixture.
- SDSs can be useful in identifying constituents in the waste, however, they should not be exclusively relied on to exclude possible contaminants. SDSs typically list constituents present at least 1% by mass (10,000 mg/kg). Concentrations much lower than this may impact hazardous waste management and waste analysis requirements.
- **Should not** use a SDS in the following circumstances:
 - If the material has been treated, mixed with other chemicals (e.g., acids with bases) or has otherwise been chemically altered (except as indicators of possible constituents).
 - If the SDS is more than five years old, unless you confirm that all of its relevant data are still accurate.
 - As a substitute for laboratory analysis of constituent concentrations when required.

In addition, where published studies are used as part of acceptable knowledge, it is important to ensure that the information is based on valid and relevant/applicable analytical techniques. The ability of analytical equipment to detect low concentrations of contaminants has improved over the years and constituents that once were determined to be “non-detectable” may, in fact, be detectable using sophisticated equipment available today.

Although EPA recognizes that sampling and analysis are not as economical or convenient as using acceptable knowledge, they do usually provide advantages. Because accurate waste identification is such an important factor for demonstrating compliance with RCRA, misidentification can present a safety hazard and may subject your facility to enforcement actions for violations of permit conditions, LDR requirements, annual reporting, and other RCRA requirements. In addition, accurate waste testing may be critical for meeting some of the requirements of other regulatory programs such as effluent discharges under the Clean Water Act, and transportation requirements regulated by the Department of Transportation.

You are cautioned to keep abreast of current regulatory developments in the RCRA program that may affect the classification of your waste, and to re-evaluate your wastes as necessary using current analytical methods and/or acceptable knowledge, particularly any time a rule affecting RCRA waste identification/classification is finalized.

1.2.3 Waste Analysis for Generators

Generators may use either sampling and analysis or acceptable knowledge in satisfying their waste classification obligations. While hazardous waste determinations might not include collecting the more detailed information that a TSDf may need, generators should consider the same concepts and limitations regarding relevance, accuracy, precision, representativeness, safety, and data quality discussed above for TSDfs when choosing an approach to waste analysis.

Tips for Generators Unfamiliar with RCRA’s Waste Determination Requirements

- Learn your legal responsibilities under RCRA and your state’s hazardous waste program by reviewing your state’s generator standards and guidance. Refer to relevant Federal Register notices and supporting documents to get a more detailed explanation of the regulations, the intent of the requirements, and how they are expected to be implemented by the regulated community. The basic obligations of generators regarding waste classification can be found at 40 CFR 262.11.
- Speak with the personnel at your site and compile paperwork to develop a collective knowledge of your generating processes, potential wastes, regulatory requirements, and opportunities for waste minimization.
- Contact your state agency, or the agency in the TSDf’s state, if you have questions (e.g., should the analyses be performed by certified laboratory?). If the state agency is not authorized to administer the RCRA program, you should contact the U.S. EPA Regional Office in which that state resides.
- Consult with a qualified consultant or TSDf for assistance in identifying, collecting and characterizing your waste.
- Join a trade association and/or subscribe to a trade newsletter to stay abreast of regulatory changes.

PART TWO: Documenting and Conducting Waste Analysis

2.0 Developing a WAP and Conducting Waste Analysis

In Part One, you identified your waste analysis and waste analysis plan (WAP) responsibilities and reviewed the methods by which you may meet these responsibilities (i.e., sampling and laboratory testing, and acceptable knowledge). In Part Two, you will learn:¹⁰

- What may be included in a WAP and how the WAP may be organized (Section 2.1)
- How to use a systematic planning process to define the objectives of your sampling and analysis program (Section 2.3)
- How to conduct waste testing, including selecting sampling parameters, strategies, and test methods to meet your objectives, as well as identifying special waste management conditions that may apply to your facility (Sections 2.2, 2.4-2.9)
- How to document your waste discrepancy and rejection policies (Sections 2.10 and 2.11)
- What recordkeeping requirements you may need to fulfill (Section 2.12)
- How to address corrective and preventative action measures (Section 2.13).

2.1 Content and Organization of the WAP

To facilitate conducting waste testing and developing a WAP, Table 2-1 provides a list of key questions arranged by facility type, that when analyzed sequentially, provide an overview for your facility to consider when planning, documenting, and conducting waste testing. Answers to the questions posed in Table 2-1 will be based on facility-specific considerations. Relevant facility-specific factors include:

Key Initial Considerations for the Facility

- WAPs are not one-size-fits-all; a WAP that is appropriate for a commercial treatment/storage/disposal facility, may not be appropriate for non-commercial treatment/disposal facilities, or even captive storage facilities.
- Do not clutter up the WAP by repeating information that exists elsewhere in the permit (e.g., basic facility description, process descriptions); however, brief summaries may sometimes be appropriate.
- Prepare procedures for subjecting wastes to an appropriate level of testing. For example, an incoming hazardous waste shipment may be incorrectly evaluated or reported by the shipper as non-hazardous. The receiving TSDF should have measures in the WAP to detect and properly evaluate such shipments.

¹⁰ This manual presents federal hazardous waste requirements. Because state hazardous waste programs may be more stringent and/or broader in scope than the federal program, you need to consult your state's regulations to learn the requirements that apply to you.

- The type of facility (i.e., generator, TSD, or both) and the operating status of the facility's regulated activities (i.e., facility is permitted, the facility is operating under interim status)
- The characteristics and quantities of wastes generated
- The types of units that are used to manage wastes on-site.

The text box on the next page, Content and Organization of WAP, recommends a format for facility WAPs that the Agency has found to be effective. While there is no required format for a WAP, addressing the ten elements in the text box will assist you in WAP development. Of course, there are other acceptable formats and facilities are encouraged to work with the permitting agency to determine the most desirable format based on their specific facility. In addition, note that a number of the elements in the text box are not specified for inclusion in the WAP by regulation; rather, EPA is recommending them based on its experience. For purposes of clarity, the text box identifies elements that are recommended and those that are mandatory. However, only those that are mandatory are required to be included in the WAP.

Additionally, it may be helpful to include documents such as sampling manuals and standard operating procedures as appendices to the WAP to increase the usefulness of the document. Refer to Appendix F of this manual for key considerations and tips for both preparing and reviewing WAPs and for inspecting facilities for compliance with their WAPs.

When the permitting agency reviews your proposed WAP and other parts of the permit application, it will likely contact you with questions, comments, and suggestions. You may want to request a meeting and/or phone call(s) with the agency prior to and/or after submitting the application to learn more about their expectations and requirements. You may also want to consider having the permitting agency visit your facility to learn more about your operations.

Generator WAP Requirements

Generators are not required to have or follow a WAP, except if managing and treating prohibited waste or contaminated soil in tanks, containers, or containment buildings regulated under 40 CFR 262.34 to meet applicable LDR treatment standards found at § 268.40 (§268.7(a)(5)). The plan must:

- Be written, kept on site in the generator's files, and made available to inspectors;
- Describe the procedures the generator will carry out to comply with the treatment standards;
- Be based on a detailed chemical and physical analysis of a representative sample of the prohibited waste(s) being treated;
- Contain all information necessary to treat the waste(s) in accordance with the requirements of Part 268, including the selected testing frequency.

Generators subject to §268.7(a)(5) should consult Part Two for guidance on developing their WAPs in accordance with applicable requirements.

Key Considerations for the Permitting Agency and Inspectors

- Become familiar with the facility; schedule a visit.
- Use clear, enforceable language when preparing permit conditions and require the same from the facility in their permit application (e.g., use "must" and "shall" as opposed to "may" or "should").
- Consider including a permit condition that requires notification of any changes to the WAP or anything outside of the flexibility of the test method.
- Maintain a generic permit template that includes all federal/state conditions. Keep it up-to-date.
- During inspections, or compliance evaluations consider using someone on-staff (Agency or Agency contractor) with a chemistry or laboratory background to evaluate WAP compliance.

Content & Organization of the WAP

1. **Purpose** Recommended
 - A. Identify requirements/permit conditions for preparing and implementing a WAP at your facility.
 - B. Provide a brief outline or overview of the WAP.
2. **Facility Description (see Section 2.2)** Recommended
 - A. Identify each hazardous waste type at your facility to include on-site managed wastes, on-site generated wastes, acceptable wastes - waste codes your facility accepts, and restricted wastes - wastes your facility does not accept.
 - B. Identify each process generating these wastes.
 - C. Provide the rationale for identifying each waste as hazardous.
 - D. Provide appropriate waste classifications (e.g., wastewater or non-wastewater).
3. **Waste Pre-Acceptance and Acceptance Processes (see Section 1.2.1, 2.7, 2.8, 2.9.1)** Mandatory
 - A. Describe the rationale, information needs, and criteria for pre-acceptance of offsite waste streams.
 - B. Describe the processes, policies, and procedures for evaluating incoming waste shipments for acceptance and appropriate onsite management.
4. **Rejection Policy (see Section 2.11)** Recommended

Describe the policies and procedures that your facility will use for the rejection of waste received by your facility.
5. **Discrepancy Policy (see Section 2.10)** Recommended

Describe the policies and procedures that your facility will use when there is a discrepancy between the waste designated on the manifest or profile and the waste received at your facility, including how the discrepancies will be resolved.
6. **Sampling Strategies and Frequency (see Section 2.5, 2.8)** Mandatory

Describe how your facility selects the appropriate sampling procedure for effective waste characterization and describe the process for determining both initial sampling frequency and subsequent waste re-evaluation.
7. **Analytical Parameters and Test Methods (see Section 2.4, 2.6)** Mandatory

Describe how your facility selects the appropriate parameters and test methods.
8. **Quality Assurance/Quality Control and Data Reporting (see Section 2.5.5, 2.6.1)** Recommended
 - A. Describe your facility's quality assurance program and quality control procedure that ensure laboratory data are scientifically valid, defensible, and of known precision and accuracy (except for test strips and visual observations).
 - B. Describe the data records your facility maintains and how long, where, and in what format each record type will be maintained
9. **Recordkeeping (see Section 2.12)** Recommended

Describe the records your facility maintains and how long, where, and in what format each record type will be maintained.
10. **Corrective and Preventative Action (see Section 2.13)** Recommended

Describe your facility's QA/QC corrective and preventative action program including the process for identifying deficiencies early and procedures for how any deficiencies will be rectified.

TABLE 2-1: Reference Guide to Key Issues for Consideration When Developing WAPs

Generators		Treatment Facilities	
Generator Only	Generators That Treat Waste in Certain Types of Units**	On-Site Only	Off-Site Only
<ol style="list-style-type: none"> 1. What is the description of the facility where wastes are generated and/or managed? (2.2)* 2. What processes result in hazardous waste generation? (2.2) 3. What is the description of the hazardous wastes that are generated? What are the waste classifications, EPA waste codes, and treatability groups, of the hazardous wastes generated? (2.2) 4. What waste parameters will be identified for testing and/or monitoring and what is the rationale for selecting these parameters? (2.4) 5. What sampling procedures (collection strategies, equipment, sample preservation methods and QA/QC procedures) will be used? (2.5) 6. How will a laboratory be selected? (2.6.1) 7. What testing and analytical methods will be used? (2.6.2) 8. What frequency for re- evaluating the waste will be established? (2.7, 2.8) 9. Will information be prepared on waste's compliance with LDRs, which can be shared with treaters and disposers? (1.1.3) 10. Are additional provisions for meeting LDR regulations required? (2.9) 	<p>Address all Generator Only information from items 1- 10 in column one. And also, answer the following:</p> <p>Before Treatment</p> <ol style="list-style-type: none"> 11. What are the applicable treatment standards with respect to the LDR regulations? (2..2, 2.9) <p>After Treatment</p> <ol style="list-style-type: none"> 12. Have all the LDR treatment standards been met? (2.9) 	<p>Address all Generator Only information from items 1- 10 in column one. And also, answer the following:</p> <p>Before Treatment</p> <ol style="list-style-type: none"> 11. What are the treatment or process design limitations for optimal safe use of equipment and materials? (2.2, 2.4) 12. What are the other operational acceptance limits applicable to permit and technological considerations (2.2, 2.4) 13. What are the applicable treatment standards with respect to the LDR regulations? (2.9) <p>After Treatment</p> <ol style="list-style-type: none"> 14. Did the treatment achieve LDR standards or is additional sampling and analysis necessary to make this determination? (2.2, 2.4, 2.5, 2.6, 2.9) 15. What new wastes, waste codes, and treatability groups were generated? (2.2) 16. Are there any additional applicable treatment standards with respect to LDR regulations? (2.2, 2.9) 17. What additional parameters of the treated materials (residues) will need to be monitored and why? (2.4) 18. How will the treated wastes be sampled? (2.5) 19. What testing/analytical methods will be used to analyze the waste (2.6.2) 	<p>Address all Generator Only information from items 1-10 in column one. And also, answer the following:</p> <p>Before Acceptance</p> <ol style="list-style-type: none"> 11. How will identification of wastes from off-site be verified? (2.4, 2.8, 2.9) 12. Will corroborative testing be conducted using full-scale analysis, fingerprinting, or other process such as acceptable knowledge? (2.4, 2.6, 2.8, 2.9) 13. How will wastes be screened for contaminants that are incompatible with the treatment process? (2.6) <p>Before Treatment</p> <ol style="list-style-type: none"> 14. What are the treatment process design limitation for optimum safe use of equipment and materials? (2.2, 2.4) 15. What are the other operational acceptance limits applicable to permit and technological considerations? (2.2, 2.4) 16. What are the applicable treatment standards for LDR regulations? (2.9) <p>After Treatment</p> <ol style="list-style-type: none"> 17. Did the treatment achieve the LDR standards or is additional sampling and analysis necessary to make this determination? (2.2, 2.4, 2.5, 2.8, 2.9) 18. What new waste/waste codes & treatability groups were generated? (2.2) 19. Are there additional applicable treatment standards with respect to LDR regulations (2.2, 2.9) 20. What additional parameters of the treated materials (residues) will need to be monitored? (2.4) 21. How will the treated waste be sampled? (2.5, 2.6) 22. What testing/analytical methods will be used to analyze the waste? (2.6)

*Numbers in parentheses indicate the pertinent section numbers.

**Treatment in tanks, containers, or containment buildings.

TABLE 2-1: Reference Guide to Key Issues for Consideration When Developing WAPs (Continued)

Storage Facilities		Disposal Facilities	
On-Site Only	Off-Site Only	On-Site Only	Off-Site Only
<p>Address all Generator Only information from items 1- 10. And also, answer the following:</p> <ol style="list-style-type: none"> Will managing wastes (e.g. mixed bulk chemicals) change the chemical properties, such that issues 12-15 below must be addressed? (2.2) How will the initial waste characterization change? (2.4) What additional sampling and analysis are required at the storage facility? (2.4, 2.5) Will a new waste identification be required and how will it be verified? (2.8) What are the applicable treatment standards with respect to LDR regulations as a result of any blending or mixing that may have occurred? (2.2, 2.8, 2.9) 	<p>Address all Generator Only information from items 1- 10. And also, answer the following:</p> <p>Before Acceptance</p> <ol style="list-style-type: none"> How will identification of wastes from off-site be verified? (2.8, 2.9) Will corroborative testing be conducted using full-scale analysis, fingerprinting or other process such as acceptable knowledge? (2.4, 2.6, 2.8, 2.9) How will wastes be screened for contaminants that are incompatible with the storage process? (2.4) <p>After Acceptance</p> <ol style="list-style-type: none"> Will managing wastes (e.g., mixed bulk chemicals) change the chemical properties, such that issues 15-17 below must be addressed? (2.2) How will the initial waste characterization change? (2.4) What additional sampling and analysis is required at the storage facility? (2.4, 2.5) Will new waste identification be required and how will it be verified? (2.8) 	<p>Address all Generator Only information from items 1- 10. And also, answer the following:</p> <ol style="list-style-type: none"> Have all wastes designated for land disposal met applicable LDR treatment standards? (2.2, 2.9) Is it necessary to conduct additional (corroborative) testing? (2.8 , 2.9) Have applicable tests been conducted to ensure no free liquids will be placed into landfills? (2.4) 	<p>Address all Generator Only information from items 1- 10. And also, answer the following:</p> <p>Before Acceptance</p> <ol style="list-style-type: none"> How will the identification of wastes from off-site be verified? (2.4, 2.8, 2.9) How will wastes be screened for contaminants that are incompatible with the disposal process? (2.4) <p>After Acceptance</p> <ol style="list-style-type: none"> What type corroborative testing will be conducted, such as full-scale testing and analysis, fingerprinting, or other process such as acceptable knowledge? (2.6, 2.8, 2.9) Have all wastes received on site for disposal met applicable LDR treatment standards? (2.2, 2.9) Are additional procedural requirements applicable for wastes from off-site? (2.9) Have applicable tests been conducted to ensure no free liquids will be placed into landfills? (2.4)

2.2 Facility Description

The facility description is an important element of an effective waste management program. The facility description should provide sufficient, yet succinct, information so that implementing federal and state regulators and WAP users can clearly understand the:

- Processes and activities that generate or are used to manage the wastes
- Hazardous wastes generated or managed
- Hazardous waste management units.

If your facility has an existing RCRA permit or is in the process of developing a permit application, the majority of facility description information should be available from other sections of the permit or permit application. However, it is also useful to include a summary of this information in the WAP. **It may be helpful for the WAP to reference where in the permit (or permit application) this information may be obtained.**

40 CFR 264/265.13 do not require WAPs to provide a facility description. However, this guidance recommends that a brief facility description (e.g., wastes and waste generating processes) be addressed in the WAP in order to aid in the efficient review of the WAP.

2.2.1 Description of Facility Processes and Activities

As a hands-on tool for ensuring compliance with applicable regulatory requirements and/or permit conditions, the WAP may need to provide a description of all on-site facility processes and activities that are used to generate or manage hazardous wastes (or reference applicable sections of the permit or permit application) that require sampling and waste testing. This information could include facility diagrams, narrative process descriptions, and other data relevant to the wastestreams subject to waste testing. Since many TSDFs, especially facilities that received waste from off-site sources, use the WAP as an operating manual, it is advisable to incorporate process descriptions directly into the document.

In addition to describing on-site processes and activities if you receive waste from off-site, you should also consider including in the WAP how process description(s) for each generator's wastestreams will be obtained, updated, and kept on file as part of the off-site TSDF operating record (which is reviewed by EPA/state inspectors). If you own or operate a TSDF, this data should enhance your knowledge of off-site generation processes and, therefore, should improve your ability to determine the accuracy of generator waste classification.

2.2.2 Identification/Classification of Hazardous Wastes Generated or Managed at Your Treatment, Storage and Disposal Facility

In addition to describing the processes and activities at your facility, you should also consider including in the WAP:

- Rationale for identifying each waste as hazardous
- Procedures and protocols for identifying wastes received from off-site sources
- Each hazardous waste type managed at your facility including:
 - On-site generated wastes
 - Off-site generated wastes
- Waste codes your facility accepts
- Wastes your facility does not accept
- Each process generating these wastes
- Appropriate EPA waste classifications (e.g., LDR classification as wastewater or non-wastewater).

Pre-Acceptance of Offsite Wastes

If the facility will receive offsite waste shipments, the WAP should include processes and procedures for pre-qualifying these wastes before the first shipment. The WAP should describe, for example, the types of information these offsite sources should provide and the facility's decision-making criteria.

Refer to Sections 1.2.1 and 2.9.1 of this manual for additional information on pre-acceptance and acceptance.

If you generate or manage a RCRA listed waste, Table 2-2 provides one possible format that you may use, to present relevant information.

TABLE 2-2: Description of Listed Wastes

Facility	Wastestream Name	Process Generating this Waste	Rationale for Hazardous Waste Designation	EPA Waste Code	LDR
					WW/NWW
FACILITY A Semi-Conductor Manufacture	Spent Degreasing Solvents (Trichloroethene)	Machinery Degreasing Operations in Bldg. 12	Contains 25% trichloroethene, cutting oils, and other non-hazardous degreasing solvents	F001	WW
FACILITY B Wood Preserving Facility	Bottom Sediment Sludge	Treatment of Wastewater from Wood Preserving Operations	Process used pentachlorophenol	K001	NWW

NWW = Non-Wastewater

WW = Wastewater

In addition to identifying all listed wastes managed (i.e., all wastes generated on-site or received from off-site), you may need to conduct testing and/or analysis to determine whether you also manage any RCRA characteristic wastes (e.g., for purposes of complying

with LDR requirements). Sampling and analysis methods that may be appropriate to identify characteristics are provided in Sections 2.5 and 2.6 of this manual. If you identify wastes as characteristic, you may choose to present relevant information as illustrated in Table 2-3, Description of Characteristic Waste.

TABLE 2-3: Description of Characteristic Waste

Facility	Characteristic Exhibited	Process Generating this Waste	Rationale for Hazardous Waste Designation	EPA Waste Code(s)	LDR	
					UHC(s)	WW/NWW
FACILITY A Pharmaceutical Manufacturer	Toxicity	Analgesic cream (see Process A-106)	Benzene > 0.5 ppm	D018	None	WW
FACILITY B Hazardous Waste Treatment Facility	Toxicity	Fuel Incineration	Cadmium > 1.0 ppm in Waste Residues	D006	None	NWW

NWW = Non-Wastewater
WW = Wastewater

ppm = parts per million

UHC = Underlying Hazardous Constituent

For TSDFs that handle many wastes, the information in Tables 2-2 and 2-3 could be simplified into broader wastestream categories (e.g., spent non-halogenated solvents) based on how each wastestream will be handled for treatment and disposal rather than by the generator or by highly specific wastestream names.

As a supplement to the above information, this portion of the WAP may also provide a listing of any wastes or waste properties that the facility is not permitted to accept (i.e., unauthorized wastes). Collectively, the identification of appropriate and unauthorized waste types should enhance the facility's ability to develop effective sampling and analytical procedures for the overall waste analysis program.

2.2.3 Description of Hazardous Waste Management Units

The final component of the facility description may need to include a description of each hazardous waste management unit at the facility that provides more detailed information regarding the specific operating conditions and process constraints for each unit.

A hazardous waste management unit is defined in the RCRA regulations as a contiguous area of land on or in which hazardous waste is placed, or the largest area in which there is significant likelihood of mixing hazardous waste constituents in the same area [40 CFR §260.10]. Examples include:

- Container storage areas. Note: A container alone does not constitute a unit; the unit includes containers and the land or pad upon which they are placed [40 CFR §260.10].
- Tanks and associated piping and underlying containment systems
- Surface impoundments
- Landfills
- Waste piles
- Containment buildings
- Land treatment units
- Incinerators
- Boilers and industrial furnaces
- Miscellaneous units.

The description of the hazardous waste management units at your facility may be provided in narrative and schematic form or a reference to the section of the permit or permit application that contains this information may be included. The narrative description could include the following:

- A physical description of each management unit with dimensions, construction materials, and components.
- A description of each waste type managed in each unit.
- A description of the methods for how each hazardous waste will be handled or managed in the unit, for example:
 - If hazardous and non-hazardous wastes will be mixed or blended, the methods for how these activities will be conducted should be described. In certain circumstances, the hazardous waste may be subject to the “mixture” or “derived-from” rules [40 CFR §§261.3(a)(2)(iv) and §261.3(c)(2)(i)]
 - If a surface impoundment will be used for neutralization of corrosive wastes, the mechanism for achieving neutralization.
- Process/design considerations necessary to ensure that waste management units are operating in a safe manner and are meeting applicable permit-established performance standards. This information may need to define specific physical and chemical operating constraints to ensure process integrity. For example, flow injection incineration facilities typically require wastes to have certain minimum and maximum levels of viscosity, heat content, and particulates for effective treatment.
- Prohibitions that apply to the facility (e.g., PCBs in the incinerator feed, storage of corrosive waste, unpermitted RCRA hazardous waste codes such as listed dioxin waste).

2.3 Systematic Planning

The process of waste analysis is one that involves the collection and evaluation of data to accurately characterize the waste. To this end, it may be helpful to define clearly the objectives of the program. One way to do this is to consider what questions you need to answer about a waste to characterize it adequately. Adequate characterization not only complies with regulatory hazardous waste management requirements, but also satisfies company goals such as cost effective waste management, reducing legal liability, and improving workplace safety.

The waste analytical process involves a number of steps including:

- Selecting the right parameters for testing
- Collecting representative samples
- Choosing a qualified laboratory
- Selecting appropriate test methods
- Quantifying data uncertainty
- Making decisions.

At each step in the process, the waste handler needs to make a number of choices (e.g., sampling method, number of samples, test methods, etc.). Small errors made during this process can result in inaccurate or inappropriate data that may result in making a wrong decision or violating the rules, including the conditions of the permit. Systematic planning processes methodically identify the considerations and approach to data collection prior to waste sampling. Systematic planning that considers the data needs best ensure (1) that your data will support your decisions; and (2) compliance with permit and regulatory requirements.

Many systematic planning process tools are available to guide planning efforts although the Data Quality Objectives (DQO) process is the most commonly used systematic planning application in the general environmental community. The DQO process may be implemented when data are being used to select between two opposing conditions, such as determining compliance with a standard.

The DQO process includes a seven step planning process as shown in Figure 2-1 and offers a structured approach to “beginning with the end in mind.” It is a framework for asking the right questions and using the answers to develop and implement a plan for data collection. The DQO process will enable you to get useful information in a cost-effective manner. The

40 CFR 264/265.13 do not specify the WAP development process described in Section 2.3. However, using the process described in this section or an alternate process of applicable rigor is recommended to ensure that quality data is generated.

FIGURE 2-1: The Seven Steps of the DQO Process

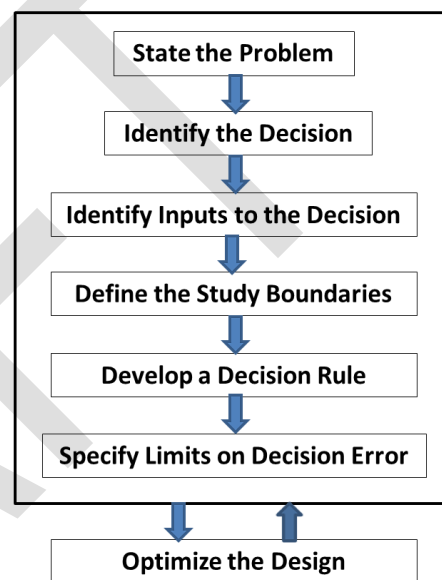

process is iterative and adaptive, as your knowledge about the decision needs to change with time. If you cannot definitively answer a question in the process, sometimes the best option is to make your best estimate and loop back to improve your plan once you have more information. The following is a brief discussion of each of the seven steps in the process. Further discussion of implementing the DQO process in your waste analytical program is included in Sections 2.4 through 2.8.

DQO Step 1 - State the Problem: In Step 1 of the DQO process, you define the problem or question you want to answer. In waste characterization, your problem may be defined by the regulations. For example, you may need to determine if a waste is hazardous or if you have met a treatment standard. Non-regulatory factors such as your company's standards may also add additional factors that affect your decision. During Step 1, you also identify who the key individual(s) will be in making decisions and determine how you will gather information. For larger projects, you may want to organize a planning team with a central leader and decision maker that is composed of personnel representing all phases of work (i.e., the waste generator, a chemist, the sampler, etc.). For smaller projects, you can streamline the planning effort to reduce costs and meet deadlines. One way you can do this is by assigning a single individual to lead the project. The project leader, however, should have the authority to make decisions and have access to the individuals with the necessary information to make the decision.

DQO Step 2 - Identify the Decision: In Step 2, you define the specific decisions that you want to make and identify the actions you may take based on the results. For example, you may not only need to make a decision to determine if a solid waste is hazardous but also how to proceed in handling the waste once it is deemed hazardous or nonhazardous. Your goal in Step 2 is to formulate a decision statement that includes both of these components. Depending on the question you are attempting to resolve, you may need to use a tiered approach of several smaller decisions (for example, 1. determine if the material is not consistent with the profile, then 2. characterize for hazardous nature and 3. determine if reactive, flammable or corrosive and 4. characterize for toxic constituents). If several separate decisions are involved, you might list the decisions in the order in which they will be resolved. Below is a simple example of possible outputs for Step 1 and 2 for a new waste that your facility has just received that may be subject to regulation due to lead.

DQO Step 1 – State the Problem

Do you need to treat the new waste to land disposal restriction (LDR) limits before disposal due to elevated levels of lead?

DQO Step 2 – Identify the Decision

Does the new waste contain lead at a concentration that exceeds the regulatory standard allowing it to be disposed at a landfill?

DQO Step 3 - Identify Inputs to the Decision: In Step 3, you identify the type and source of the information to answer the question from Step 2. For RCRA-related programs, you typically need to collect samples, measure parameters, and integrate generator acceptable

knowledge. This should include identifying possible sample and analytical methods; but keep in mind that these methods may need to be revised as more information is gathered. The potential source(s) of this information (e.g., laboratories) are also identified. Discussions specific to selecting waste parameters, sampling methods, testing methods, and identifying laboratories qualified to perform those methods are discussed in detail in Sections 2.4 through 2.6. The output of Step 3 for the lead waste example is outlined below.

DQO Step 3 – Identify Inputs to the Decision

Identify the type of information/sources needed to resolve the decision:

- Measurement of the concentration of lead in leachate using the TCLP extraction technique.
- Use of existing data from the generator to determine waste variability.

Identify the appropriate sample and analytical methods:

- Sampling of the waste for lead per 40 CFR 261 Appendix I.
- Use of the SW-846 TCLP Method 1311 to produce the leachate.
- Use of the SW-846 Methods 3010 and 6010 to prepare and analyze the sample.

DQO Step 4 – Define Study Boundaries: In Step 4, you will define both the spatial and temporal boundaries of the waste unit and determine any additional constraints on data collection. The spatial and temporal boundaries help to determine the waste to which your decision criteria apply.

- **Spatial boundaries** define the physical area to which the data applies and the locations where samples are taken.
- **Temporal boundaries** describe the time frame the data represent and when the samples are taken.

When waste is limited to a single container, the spatial boundaries are defined by the physical boundaries created by the container. In other cases, the spatial boundaries may be less clear. For example, it may be an area (e.g., an accumulation area). Even within a single container, however, there may be other aspects to consider when defining the spatial boundaries like how evenly (homogeneous) or unevenly (heterogeneous) the hazardous constituent(s) are distributed. For example, you may need to sample a heterogeneous waste much differently than a homogeneous waste to obtain a representative sample.

The heterogeneous waste may in many cases warrant collection of additional samples. Two examples of heterogeneous wastes include liquid wastes with multiple layers and a solid waste that contains “hot spots.” For a discussion of sampling strategies for both homo- and heterogeneous wastes, see Section 2.5.

Temporal boundaries help determine the timeframe to which the decision applies. It may be defined operationally (e.g., a “batch” of waste) or by a permit or regulation (e.g., waste generated per day). In addition to spatial and temporal boundaries, your project decision may also be bound by a threshold value, or “action level” that you can use to answer your

question. Specifically, the **action level** is a value that causes a decision maker to choose between two actions. Your action level may be a regulatory threshold expressed as a concentration for a hazardous constituent (e.g., an LDR numeric treatment standard) or it may be defined by a property of the waste as defined in RCRA (e.g., corrosivity). You may also be bound by practical constraints that can include having limited physical access to the waste being sampled or worker health and safety concerns. You should identify all boundaries and practical constraints in DQO Step 4. The boundaries and constraints for the lead waste example are defined below.

DQO Step 4 – Define the Study Boundaries

Spatial & Temporal Boundaries:

- The container boundaries of the 10-cubic yard roll off box define the spatial boundaries.
- The waste seems to be homogeneous based on existing data from the generator.
- This is a new waste. The decision will apply to this load only.

Additional Constraints:

- The LDR treatment standard (action level) is 0.75 mg/L TCLP for lead in leachate non-wastewater.

DQO Step 5 – Develop a Decision Rule: In Step 5, you take the output from the previous steps and develop a decision rule. The decision rule is a single statement in which you describe how to use the data to make a decision. In the decision statement, you should also specify how to compare sample results to the action level. That is, compare each individual sample result to the action level or use another method like comparing the mean of the results to the action level. In the lead waste example scenario, as RCRA typically only requires a single exceedance of the LDR treatment standard to make the waste ineligible for landfill disposal under 40 CFR Part 268, you may need to compare the action level to each sample individually. The decision rule for the lead waste example is outlined below.

DQO Step 5 – Develop a Decision Rule

If any individual sample result is greater than the LDR treatment standard (action level) of 0.75 mg/L TCLP for lead in the leachate non-wastewater (F039), then the waste does not meet the LDR treatment standard and is not eligible for land disposal under 40 CFR Part 268. Otherwise, the waste will be considered suitable for landfill disposal for lead under 40 CFR Part 268.

DQO Step 6 – Specify Limits on Decision Error: In Step 6, you identify the certainty or level of confidence that you need in your data, since you rarely have complete confidence that your decisions are correct due to the non-homogeneity of most wastes and slight differences in how you handle, sample, and analyze the waste. The appropriate degree of certainty for each decision unit is unique and can be determined by considering the consequences of making a wrong decision. If you consider a waste hazardous when it is not, the consequences would be the increased cost of unnecessarily treating the waste before disposal. If, however, you consider a waste nonhazardous when it is in fact hazardous, the consequences may include

potential future legal or financial liability problems for the owner that are much more consequential and costly.

For these reasons you should evaluate your data to ensure that not only are sample results below the action level but that you have an appropriate degree of certainty that any subsequent sample collected from the decision unit would also be below the action level. One way that you can express the degree of certainty in your data is by establishing a **confidence level**. A confidence level indicates the degree of certainty of your data in terms of a percent (i.e., 90% single tailed confidence level as specified in SW-846, Chapter Nine). For example, a 90% confidence level means that you are 90% certain (10% uncertain) that any additional sample will also be below the action level. To apply a specific confidence level to your data, you determine the **confidence limits** statistically. Confidence limits are the upper and lower limits that your data need to fall within to meet a specific confidence level. Most action levels will be based on regulatory standards that are not to be exceeded (or equaled), so normally the upper confidence limit is used.

In the lead waste example, the action level is based on the LDR regulatory limit for lead in leachate non-wastewater, which is 0.75 mg/L TCLP. As the potential negative consequence for making a wrong decision is high in this instance (regulatory penalties for noncompliance, etc.), a high level of confidence (90% certainty) in the data is appropriate. Applying a 90% confidence level will reduce the chances of the facility being noncompliant with the regulations. For more detail on how to calculate the upper bound of a confidence limit, please see the example in Section 2.7, Quantifying Data Uncertainty.

The output of Step 6 is a more detailed decision statement that expresses the decisions with the confidence limit, which is sometimes referred to as the **DQO Statement**.

DQO Step 6 – Specify Limits on Decision Error

If any individual sample result in the leachate non-wastewater (F039) is greater than 0.75 mg/L for lead in TCLP leachate or greater than the 90% upper confidence limit, then the waste does not meet the LDR treatment standard and is not eligible for land disposal under 40 CFR Part 268. Otherwise, the waste will be considered suitable for landfill disposal for lead under 40 CFR Part 268.

DQO Step 7 – Optimize the Design: Step 7 is the final step in the DQO process. In Step 7, you review the outputs from the previous six steps and determine if you have all of the appropriate information that you need or if there are still data gaps. For example, you may need to revisit the analytical method you chose in Step 3 if you determine it is not sensitive enough to meet your action level. After you have eliminated any remaining data gaps, you can identify an optimal design for collecting your data in a cost-effective manner to meet your DQO Statement. This will likely include finalizing the selection of sampling and analytical methods and determining the appropriate number of samples to collect. You should also document your decision and take the appropriate actions to ensure that all staff involved in sample collection and testing understand and properly implement the sample design.

Further information on systematic planning and the DQO process can be found in the following sources:

- US EPA Guidance on Systematic Planning Using the Data Quality Objectives Process, EPA QA/G-4, EPA 240-B-06-001, 2006. <http://www.epa.gov/quality/qs-docs/g4-final.pdf>
- US EPA RCRA Waste Sampling Draft Technical Guidance, EPA 530-D-02-002, 2002. http://www.epa.gov/epawaste/hazard/testmethods/sw846/samp_guid.htm
 - For a more detailed discussion of the DQO Process - See Chapter Four entitled, “Planning Your Project Using the DQO Process”
 - For more examples of applying the DQO Process to waste analysis – See Appendix I entitled, “Examples of Planning, Implementation, and Assessment for RCRA Waste Sampling.”

2.4 Selecting Waste Analysis Parameters

An accurate representation of a waste’s physical and chemical properties is critical in determining viable waste management options. Accordingly, the facility’s WAP must specify waste parameters that provide sufficient information to ensure:

40 CFR 264/265.13(b)(1) require that WAPs specify parameters for which each hazardous waste, or non-hazardous waste if applicable, will be analyzed and the rationale for the selection of these parameters.

- Compliance with applicable federal regulatory requirements (e.g., LDR regulations, including underlying hazardous constituents, newly identified or listed hazardous wastes)
- Compliance with applicable state regulatory requirements for those states that are authorized to implement the RCRA hazardous waste program
- Conformance with permit conditions (i.e., ensure that wastes accepted for management fall within the scope of the facility permit, and that process performance standards can be met)
- Safe and effective waste management operations (i.e., ensure that no wastes are accepted that are incompatible or inappropriate given the type of management practices used by the facility).
- Attention to the above factors when developing a WAP should orient you toward the major considerations for selecting waste analysis parameters. **Your facility should keep in mind that the parameter selection process can be an iterative process, and that you may want to select final parameters with regulators.** The following discussion provides more definitive guidance to help you determine the specific parameters to be incorporated into your WAP.

2.4.1 Criteria for Parameter Selection

Waste analysis parameters are designed to develop the information necessary for safe and effective waste management. Due to the diversity of hazardous waste operations and the myriad of operating variables, the identification of the most suitable parameters to be sampled and analyzed can be complex, especially for large TSDFs. To this point, relevant waste analysis parameter selection criteria can be developed and reviewed systematically to efficiently identify parameters of interest. Generally, these selection criteria may be organized into the following categories:

- Waste identification
- Identification of incompatible/ unauthorized wastes
- Process and design considerations.

Each major category where selection criteria are to be applied is described below.

Waste Identification

A prerequisite step in proper waste management is the identification of hazardous wastes in accordance with regulatory and permit requirements. Generators and TSDFs must evaluate (through testing or applying acceptable knowledge) solid wastes to determine if the wastes are hazardous in accordance with state regulations and the RCRA characteristics and listings set forth in 40 CFR Part 261, Subparts C and D. In addition, pursuant to the LDR regulations, they must determine whether hazardous wastes are restricted from land disposal according to 40 CFR Part 268. If the generator determines that his waste is subject to the LDR requirements, he must comply with the LDR notification and certification requirements at 40 CFR §268.7.

Accordingly, an effective waste analysis plan not only specifies the parameters that may be necessary to ensure that wastes accepted by the TSDF are accurately identified and fall within the scope of the facility permit (where applicable), but also may need to include provisions to ensure that applicable LDR requirements are fulfilled. Waste analysis requirements for generators and TSDFs, including the LDR provisions for underlying hazardous constituents (UHCs) are presented in Section 1.1.1.1.

Characteristic Waste and Underlying Hazardous Constituents (UHCs)

Characteristic hazardous waste (per 40 CFR §§261.21-.24) must comply with the special requirements set forth in 40 CFR §268.9. This includes addressing UHCs.

When determining the LDR treatment standard for the characteristic waste, you must consult the table of standards in 40 CFR §268.40 to determine whether you are responsible for meeting “§268.48 standards” and, if so, you must identify any constituents that are reasonably expected to qualify as UHCs at the point of generation.

If UHCs are identified, the waste cannot be disposed in a landfill until the waste:

- No longer exhibits the characteristic, and
- Meets the concentration-based universal treatment standard (s) in 40 CFR §268.48 for each regulated constituent (i.e., UHC) in the waste.

TSDFs are still responsible for meeting the LDR treatment standards for all constituents subject to the LDR requirements, regardless of the constituents identified by the generator. TSDFs may consult a variety of reference materials pertaining to the types of wastes to be managed when specifying parameters to corroborate waste identification under RCRA, including:

- 40 CFR Part 261, Appendices VII and VIII (i.e., the basis for listing hazardous wastes, and hazardous constituents, respectively)
- Applicable state hazardous waste regulations
- Industry and trade association hazardous waste profile studies
- EPA Background Documents, for RCRA listed and characteristic hazardous wastes.

Another consideration in selecting waste analysis parameters, especially if you are the owner/operator of a TSDF that accepts waste from off-site facilities, is determining when you may need to conduct a full waste characterization versus abbreviated or targeted analysis, sometimes referred to as “fingerprint analysis.” A full waste characterization may be appropriate when:

- A generator begins a new process or changes an existing process
- Wastes are received by a facility for the first time
- A generator has not provided appropriate waste profiles or laboratory information to an off-site TSDF
- A facility may want to verify that generator supplied waste information (routine) is accurate
- An off-site TSDF has reason to suspect that the wastes received were not accurately identified by the generator (non-routine)
- EPA changes RCRA waste identification/classification rules

Abbreviated or fingerprint analysis is conducted generally for parameters (e.g., specific gravity, color, flash point, presence of more than one phase, pH, halogen content, cyanide content, percent water) that will give information that can be used to help verify that the waste generated, or received by an off-site TSDF, matches the expected characteristics for that waste. For example, at an off-site TSDF, abbreviated analysis can be used to verify that the waste received matches the description on the manifest, and that the waste matches the waste type that the facility has agreed to accept. Where the owner/operator of a TSDF already knows the detailed chemical and physical properties of a waste, appropriate target or spot check parameters can be selected to verify that each waste arriving at the gate of the TSDF matches its profile.

Sampling frequencies and waste re-evaluation frequencies are discussed in additional detail in Sections 2.5.1 and 2.8, respectively.

Identification of Incompatible/Unauthorized Wastes

Regulatory requirements [40 CFR §§264/265.17] and good management practices dictate that incompatible (e.g., acids and bases) or unauthorized wastes be identified prior to waste management. If combined, incompatible wastes are capable of spontaneous combustion, toxic gas generation, or explosions. Compatibility testing may include determining water reactivity (e.g., foaming, generating heat, explosiveness); oxidation-reduction potential, spot tests for cyanide and sulfide, among others, with the objective to:

- Ensure compatibility of waste with accumulation/storage tanks and containers;
- Determine compatibility of separate waste streams prior to commingling;
- Avoid accumulating incompatible wastes in the same storage location; and/or
- Ensure that tanks/containers that were used to store a different wastestream have been adequately cleaned.

In addition, accepting wastestreams not authorized for your facility operations may violate permit conditions. Examples of unauthorized wastes may include PCBs and listed dioxin wastes. The selection of waste parameters therefore must include measures to screen for and identify these types of waste prior to acceptance.

Suitable parameters for identifying incompatible and unauthorized wastes will vary according to facility-specific operating and permit conditions. To determine if particular wastes or wastes and storage units are compatible, the RCRA regulations list some common potentially incompatible wastes [40 CFR Part 264, Appendix V]. For compatibility of wastes not listed in the regulations, the facility may need to test the waste and the unit for compatibility. Parameters and analytical methods for ignitable and corrosive waste are contained in chapters seven and eight of SW-846, respectively. The EPA document: "A Method for Determining the Compatibility of Hazardous Wastes" (EPA 600-2-80-076) [An electronic copy of this document can be downloaded from the National Service Center for Environmental Publications (NSCEP) at <http://nepis.epa.gov>] contains guidance on qualitatively evaluating the compatibility of various types of wastes.

Process and Design Considerations

The effectiveness of a facility's waste handling operations and associated management units are subject to process and equipment design limitations. These operating constraints determine the range of wastes and waste properties (e.g., constituent concentrations, pH, etc.) that may be safely managed in a given process while maintaining regulatory and permit compliance. Thus, the facility WAP should consider including such provisions to ensure that physical and chemical analyses provide the information needed to identify any waste properties that may exceed technical/equipment design limitations, as well as regulatory and permit limitations (e.g., inorganic feed rates, BTU values, chlorine/metal content). Potential risks to facility personnel and structures, compliance status, and possible impacts to off-site human health and the environment that may result from exceeding facility

operational limitations emphasize the need to identify relevant parameters affecting treatment, storage, and disposal prior to acceptance for management. Similarly, because waste composition may change while being managed at an on-site facility, processes and designs should be reviewed for all phases of waste management (i.e., pre-process, in-process, and post-process) when selecting waste analysis parameters. For example, where multiple treatment processes are used, waste composition changes resulting from a pretreatment process may preclude its subsequent management by certain other hazardous waste units at the facility.

Technical/equipment design operating constraints may determine the range of physical and chemical properties that are acceptable for a given waste management operation. Waste analysis parameters may need to be selected to provide both a qualitative and quantitative measure of these conditions. Typically, these waste analysis parameters are used to determine if (1) the waste composition is atypical of that normally handled by the facility; and/or, (2) acceptance or further management (without pretreatment) of the waste may compromise the performance goals of the waste management process.

In addition to selecting these waste analysis parameters, you may need to ensure that applicable regulatory requirements and permit conditions are met while protecting waste management unit performance goals and structural integrity. **Major factors to consider when selecting parameters for evaluating operational limits are listed below:**

- Types of waste to be managed
- Volumes of waste to be managed
- How waste was received from off-site, if applicable (e.g., drums, roll-offs)
- Source of waste (i.e., on-site, off-site generator)
- Method of storage, transfer or treatment, if applicable (e.g., stabilization)
- Types of units in which the wastes will be managed
- Construction materials of the unit
- Location of the unit (e.g., proximity to property boundary)

This list is not exhaustive and, therefore, other operational factors applicable to your facility may need to be considered.

2.4.2 Parameter Selection Process

As stated previously, a systematic evaluation of relevant waste analysis criteria (i.e., those associated with waste identification, identification of incompatible/unauthorized wastes, and process and design considerations) is useful for efficiently identifying waste parameters. To this end, Figure 2-2 Waste Analysis Parameter Selection Process illustrates a systematic process which can be used to develop a comprehensive inventory of applicable waste

parameters. This tool is designed to be applied to each hazardous waste management unit individually so that parameter selections for each unit are developed through separate iterations of the flow process. In addition, attention may need to be given to any pre-, in-, or post-process variables that may require selection of additional or different parameters.

FIGURE 2-2: Waste Analysis Parameter Selection Process

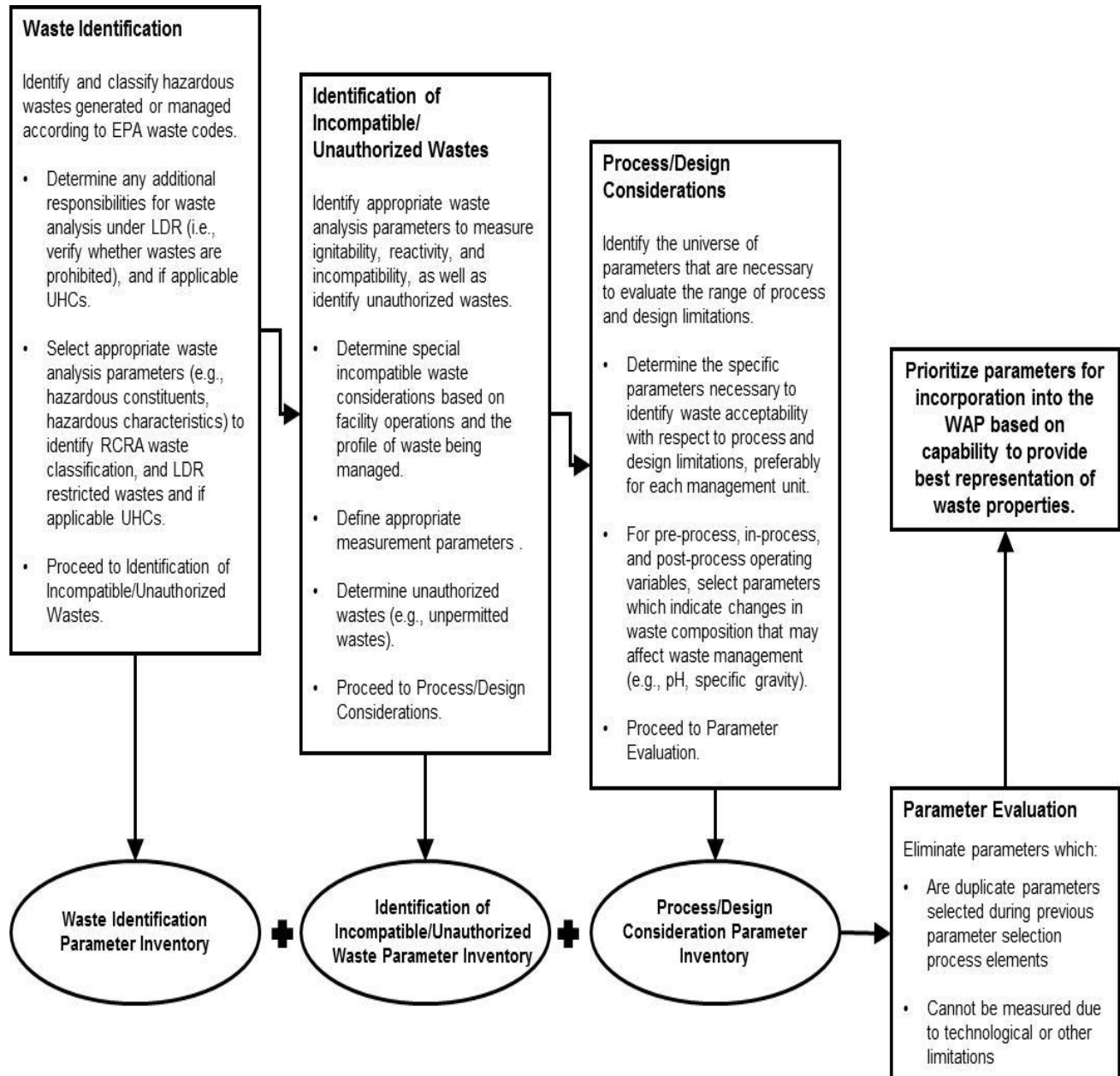

2.4.3 Rationale for Parameter Selection

Along with identifying waste analysis parameters, the RCRA regulations [40 CFR §§264/265.1(b)(1)] require that the WAP provide the rationale for the selection of each parameter. The rationale must describe the basis for waste analysis parameters and how selected, and how each will measure the physical and chemical waste properties such that wastes are managed within regulatory and permit conditions, as well as process and design limitations. This information will assist regulators and WAP users with evaluating the viability of parameter selection, the appropriateness of incorporating parameters in the WAP, and may help eliminate extraneous waste analysis parameters.

2.4.4 Special Parameter Selection Requirements

Where applicable, WAPs may also need to include procedures and parameters for managing specialized wastes in particular hazardous waste management units as follows:

- Facilities managing ignitable, reactive, or incompatible wastes
- Bulk and containerized liquid wastes for landfills
- TSDF process vents
- Equipment leaks
- Hazardous waste combustors [40 CFR §63.1209(c), §63.1208(b)(8), §§264/265.341, §266.102(a), and §266.103(a), as applicable]

Sampling, analytical, and procedural methods that will be used to meet these additional waste analysis requirements for specific waste management units must be included, where applicable, in your WAP [40 CFR §§264/265.13(b)(6)]. For reference purposes, these special requirements are discussed below.

Ignitable, Reactive, and Incompatible Waste Analysis Requirements

WAPs must include provisions to ensure that waste management units meet the special requirements for ignitable, reactive, and incompatible wastes [40 CFR §§264/265.17]. Standard tests to identify ignitable, corrosive, and toxic wastes are contained in Chapter 8 of SW-846. You should identify reactive wastes as such if they exhibit at least one of the eight properties identified in 40 CFR §261.23. As EPA does not currently have a set of approved methods for determining reactivity, generators should use acceptable knowledge or appropriate tests that have been developed to measure these properties to determine if their waste exhibits the characteristic of reactivity. Incompatible wastes, if brought together, could result in heat generation, toxic gas generation, and/or explosions. Finally, waste compatibility determinations can serve to establish compatibility between wastes of interest for a given process. To determine if particular wastes or storage units are compatible, consult the RCRA regulations list of some common potentially incompatible wastes [40 CFR Part 264,

Appendix V]. For compatibility of wastes not listed in the regulations, the facility may need to test the waste and the unit for compatibility.

Further information on waste compatibility:

- US EPA, A Method of Determining the Compatibility of Hazardous Wastes, EPA 600-2-80-076, 1980. An electronic copy of this document can be downloaded from the NSCEP site at <http://nepis.epa.gov>.
- Design and Development of a Hazardous Waste Reactivity Testing Protocol. [EPA-600/52-84-057](#), U.S. Environmental Protection Agency, Municipal Environmental Research Laboratory, Cincinnati, Ohio, 1984.

Special Requirements for Bulk and Containerized Liquids in Landfills

Owners/operators of hazardous waste landfills must ensure that free liquids are not placed into the landfill and that restrictions on containerized liquids are met [40 CFR §§264/265.314]. Specifically, bulk and/or non-containerized liquids or wastes containing free liquids are not to be placed into a landfill. In addition, containers holding free liquids should not be placed in a landfill unless all free-standing liquids: (1) have been removed by decanting, or other methods; (2) have been mixed with a nonbiodegradable absorbent or have been solidified so that free-standing liquid is no longer observed; or (3) have been otherwise eliminated. Limited exceptions to the placement of containers holding free liquids in landfills include, very small containers, containers designed to hold free liquids for reasons other than storage (e.g., some batteries, capacitors), and lab packs. A WAP should identify the procedures to ensure that these requirements are met, and if applicable, describe the procedures that will be used to determine whether a biodegradable sorbent has been added to the waste in the container.

Considerations for Landfill WAPs

The WAP may need to include a requirement for testing for free liquids in containers or, if free liquids are not otherwise expected to be present in a container, then a visual inspection. If the visual inspection detects free liquids, appropriate steps may be required (e.g., performance of free liquids test, elimination of free liquids, etc.).

TSDF Process Vent Analysis Requirements

TSDF owners/operators are required to identify and meet specific technical requirements for all process vents associated with distillation, fractionation, thin-film evaporation, solvent extraction, and stripping processes that manage wastes with a 10 ppmw (ppm by weight) or greater total organics concentration on a time weighted annual average basis [40 CFR §§264/265.1034(d)]. The applicability of these process vent requirements is established by measuring total organic concentrations in the waste using SW-846 Method 9060. The determination that relevant processes are managing organic waste below the regulated threshold must be made as follows: (1) by the effective date that the facility becomes subject to the requirements; and, (2) for continuously generated wastes, annually, or whenever there is a change in the process or waste being managed. WAPs need to include the procedures and parameters for managing process vents.

Equipment Leak Waste Analysis Requirements

TSDF owners/operators may need to determine if equipment contains or contacts organic wastes with 10 percent or greater total organic content. This trigger threshold may be determined by using the following: (1) methods described in ASTM methods D 2267-88, E 169-87, E 260-85; (2) Method 9060 of SW-846; or, (3) applying acceptable knowledge of the nature of the hazardous wastestream or the process by which it was produced. If the organic concentrations meet these regulated levels, emission control and monitoring standards apply to each valve, pump, compressor, pressure relief device, open-ended valve or line, flange or other connector and associated air emission control device or system. WAPs need to include the procedures and parameters for managing equipment leaks.

Hazardous Waste Combustors

Certain types of hazardous waste combustors (incinerators, cement kilns, lightweight aggregate kilns, boilers, and hydrochloric acid (HCl) production furnaces) are subject to applicable regulatory requirements pursuant to both the RCRA program and the Clean Air Act (CAA) National Emission Standards for Hazardous Air Pollutants (NESHAP) program. Prior to the adoption of the CAA Hazardous Waste Combustor (or HWC) NESHAP standards, emissions from all RCRA hazardous waste combustion units were regulated according to 40 CFR Parts 264 and 265 (for incinerators) and 40 CFR Part 266 (for Boilers and Industrial Furnaces). Thus, the RCRA emission standards/limitations and related operating requirements resided in the RCRA permit or interim status regulations, and all waste analysis requirements were located in the waste analysis plan (WAP). Between 1999 and 2005, EPA established new CAA HWC NESHAP emission standards, testing and operating requirements for incinerators, cement kilns, lightweight aggregate kilns, boilers, and HCl production furnaces burning hazardous waste. The CAA HWC NESHAP is codified in 40 CFR Part 63, subpart EEE.

In order to avoid (to the extent practicable) having duplicative coverage of emission standards and operating requirements in the RCRA permit and the CAA notification of compliance and Title V permit, EPA finalized a regulatory approach allowing a facility to modify its RCRA permit to remove most or all emission standards and emission related operating requirements that are covered by the CAA HWC NESHAP once the source demonstrated compliance with 40 CFR Part 63, subpart EEE. Under this approach, the CAA HWC NESHAP emission standards and emission related operating requirements reside in the CAA notification of compliance and Title V permit, while the other RCRA requirements associated with the combustion unit and the facility remain in the RCRA permit. Examples of requirements that continue to be part of the RCRA permit for HWCs include general facility standards, WAPs, closure plans, contingency plans, financial assurance, corrective action, and RCRA omnibus provisions.

With respect to the RCRA WAP, it should not be confused with the CAA HWC NESHAP feedstream analysis plan (FAP). While there are separate waste analysis requirements for HWCs under the different statutory programs, the requirements are closely related and should be coordinated to the extent practicable. (See the discussion of hazardous waste combustors in Appendix D of this manual for a crosswalk table which highlights the similarities between the RCRA WAP and CAA FAP and identifies sections of this manual that may be of assistance in developing a CAA FAP.) As discussed in greater detail in section 2.9.2 (Procedures for Combustion Facilities), the RCRA WAP would include, for example, general RCRA waste analysis requirements that ensure safe receipt and management of wastes¹¹ (inclusive of all non-combustion hazardous waste management activities), as well as (if needed) waste analysis requirements necessary to ensure compliance with the more stringent (relative to MACT) emission and feedrate limitations determined necessary as a result of a site-specific risk assessment. Specifically, the RCRA WAP serves to screen the incoming waste to the facility which will be treated, stored, and/or disposed, as well as to screen out wastes that are prohibited from going to the combustion unit. The CAA FAP focuses on the waste before being fed to the combustor to ensure compliance with the CAA HWC NESHAP emission standards and feedstream related operating requirements.¹² Thus, the FAP can be thought of as a subset of the facility's RCRA WAP, since the incoming waste affects what is ultimately combusted.

As alluded to in the previous paragraph, there are limited circumstances in which a RCRA WAP may need to include waste analysis requirements necessary to ensure compliance with emission-related limitations for combustion units that are also subject to the CAA HWC NESHAP. This may occur when:

- The RCRA permit review determines that the CAA HWC NESHAP standards are not sufficient to protect human health and the environment for a specific facility. In that case, the RCRA permit may include additional feedrate limitations/controls, based on the results of a site-specific risk assessment, and the WAP may include procedures to ensure compliance with them.
- The owner/operator elects to comply with one of the "RCRA Options" in 40 CFR §270.235 for minimizing emissions during periods of startup, shutdown, and malfunction.
- Boilers or HCl production furnaces that are area sources under the CAA and elect to comply with certain standards for particulate matter, metals other than mercury, hydrogen chloride and chlorine under RCRA Part 266, Subpart H instead of the CAA HWC NESHAP standards. (See 40 CFR §63.1218(e).)

It is important to note that there are other types of RCRA thermal treatment units that are not subject to the CAA HWC NESHAP under 40 CFR Part 63, Subpart EEE. For example, carbon regeneration units, open burn/open detonation units, and sulfuric acid production

¹¹ See 40 CFR §§264.177, 264.198, and 264.199

¹² Also, the CAA HWC NESHAP requires feedstream analyses that are specific to the comprehensive and confirmatory performance tests to ensure these tests accurately quantify the levels and amounts of contaminants that are fed into the combustion unit during these tests. See 40 CFR §63.1207(f)(iv).

units, are not regulated pursuant to the CAA HWC NESHAP requirements, but are rather regulated pursuant to the applicable RCRA standards for Miscellaneous Units (see 40 CFR Part 264, Subpart X) or BIFs (see 40 CFR §§266.102 and 266.103) Thus, these facilities are only subject to the RCRA WAP requirements, which include, among others, RCRA WAP feedstream characterization requirements prior to treatment to ensure compliance with applicable BIF or Subpart X pollutant feedrate and emission limitations.

Also, some boilers and HCl production furnaces are not necessarily subject to the full suite of CAA HWC NESHAP standards. Only boilers and HCl production furnaces that are determined to be “major sources”¹³ are required to comply with all CAA HWC NESHAP standards. Boilers and HCl production furnaces that are not major sources are considered “area sources” and have the option to either comply with the full suite of CAA HWC NESHAP standards or a mix of CAA HWC NESHAP standards and RCRA emission standards. Specifically, area sources that choose not to be subject to the full suite of CAA HWC NESHAP standards are subject to the CAA HWC NESHAP standards for mercury, dioxin/furans, carbon monoxide/hydrocarbons, and destruction and removal efficiency, while the RCRA standards under Part 266, Subpart H for particulate matter, metals other than mercury, and hydrogen chloride and chlorine apply. For additional information, see 40 CFR §§266.100(b)(3), 270.22, 270.66, and the final rule preamble ([70 FR at 59433-34 \(October 12, 2005\)](#)). As a result, the RCRA WAP would need to cover these pollutants to ensure compliance with RCRA feedrate limitations that are then used to ensure compliance with the RCRA controlled emissions not covered by the CAA HWC NESHAP requirements.

In summary, the RCRA WAP is still a required component of a RCRA permit for all RCRA facilities that are also subject to the CAA HWC NESHAP standards for the following reason:

The RCRA WAP is needed to ensure the applicable general waste analysis requirements found in 40 CFR §264.13 are being met for both on-site and off-site combustion sources (e.g., verifying waste received from off-site sources matches the waste identified on the manifest, identification of the hazardous constituents, including the ignitable/reactive/corrosive characteristics, and verifying the compatibility of the hazardous waste prior to mixing that waste with other wastes in tanks or containers prior to further treatment or disposal at the facility).

¹³ As defined in the CAA, a major source is any stationary source that emits or has the potential to emit 10 tons per year (tpy) or more of any single HAP or 25 tpy or more of any combination of HAP. An area source is a stationary source that is not a major source. Generally, NESHAP standards do not apply to area sources. However, EPA chose to regulate certain area source HWCs (incinerators, cement kilns and lightweight aggregate kilns) under the NESHAP standards. Therefore, all incinerators, cement kilns, and lightweight aggregate kilns must comply with NESHAP standards. A separate decision was made for boilers and HCl production furnaces such that those area sources have the option to comply with all or some of the NESHAP standards. Lastly, EPA determined that all HWC area sources are required to have a CAA Title V permit.

2.5 Selecting Sampling Procedures

Sampling is the physical collection of a representative portion of a waste or waste treatment residual. To be representative, a sample needs to be collected and handled in a way that preserves its original physical form and chemical composition and prevents contamination. For a sample to provide meaningful data, it is important that it reflect the properties of the waste from which it was obtained, that its physical and chemical integrity be maintained, and that it be analyzed within a dedicated quality assurance program.

40 CFR 264/265.13(b) and (c) require that WAPs address sampling methods which will be used to obtain representative samples. Note: Although this section includes sampling information relevant to both hazardous waste and LDR determinations, the need for “representative sampling” applies to hazardous waste, but not LDR, determinations. For additional information, refer to the LDR Phase IV final rule at [Federal Register 63:100 \(26 May 1998\) p. 28562](#).

Due to the diversity of hazardous wastes and the number of possible generation (e.g., batch, continuous feed) and waste management scenarios (e.g., drums, roll-off boxes, tankers, and lugger boxes), the type(s) of sampling procedures will vary. The following subsections discuss the proper procedures and considerations for sample collection, sample preservation, quality assurance/quality control (QA/QC), and occupational health and safety.

TSD Facilities and Generators:

Refer to your state’s requirements that apply to you, as they may be more stringent and/or broader in scope than the federal program.

Only the methods referenced in Appendix I to 40 CFR 261 are discussed in this guidance manual. These methods have two sources: the American Society for Testing and Materials (ASTM) methods and EPA’s SW-846. In particular, SW-846 has been developed by EPA to assist the regulated community in meeting analytical responsibilities under RCRA.

2.5.1 Sampling Strategies and Sampling Frequencies

An accurate representation of a waste’s physical and chemical properties is critical in determining viable waste management options. Accordingly, a facility’s WAP must specify waste parameters that provide sufficient information to ensure:

- Compliance with the applicable regulatory requirements (e.g., LDR regulations, newly identified or listed hazardous wastes)
- Conformance with permit conditions (i.e., ensure that wastes accepted for management fall within the scope of the facility permit, and process performance standards can be met)

Sampling Methods and Quantities:

Although a single grab sample is easy and inexpensive to collect, it may not be adequate to characterize a waste stream. The sampling methods and quantities used need to be representative of the waste stream being sampled as required by regulation.

- Safe and effective waste management operations (i.e., ensure that no wastes are accepted that are incompatible or inappropriate given the type of management practices used by the facility).

Sampling Strategies

- The development and application of a sampling strategy is a prerequisite to obtaining a representative sample capable of producing scientifically viable data. Strategies may need to be selected or prepared prior to actual sampling to organize and coordinate sampling activities, to maximize data accuracy, and to minimize errors attributable to incorrectly selected sampling procedures. A sampling strategy may need to address the following:
 - Types of samples needed (e.g., grab samples or composite samples)
 - Selection of sampling locations
 - Number of samples
 - Sampling frequency
 - Sample collection and handling techniques

In addition, the following factors may also need to be taken into consideration for the wastes to be sampled since they can influence the sampling development process:

- Physical properties
- Chemical properties
- Special circumstances or considerations (e.g., complex multi-phase wastestreams, highly corrosive liquids, oily sludges) that may require the wastes be homogenized prior to sampling or other techniques be used to obtain a representative sample. Conversely, if a facility is conducting phase separation as a treatment of a waste, each phase of the waste may need to be sampled and analyzed separately.

Based upon the data objectives and other considerations identified in the sampling strategy, two major sampling approaches may be employed to collect representative samples. These approaches are summarized as follows:

Authoritative Sampling - where sufficient historical, site, and process information is available to accurately assess the chemical and physical properties of a waste, authoritative sampling (also known as **judgment sampling**) can be used to obtain representative samples. Sample locations are selected based on knowledge of waste properties (e.g., homogeneous process streams) and level of uniformity or waste distribution, as well as waste management units. The validity of authoritative sampling is dependent upon the accuracy of the information used. The rationale for selection of sampling locations is important and should be documented.

Random Sampling - due to the difficulty in determining the exact chemical and physical properties of most hazardous wastestreams (needed for using authoritative sampling), random sampling strategies are most commonly used. Random sampling is based upon mathematical and statistical theories and can ensure that representative samples are obtained from almost any waste. Generally, three specific techniques, **simple, stratified, and systematic random**, are employed. Table 2-4 Sampling Approach Overview provides a summary of both authoritative and random sampling definitions, applicability, and limitations. Figure 2-3 Illustration of Random, Stratified Random, and Systematic Sampling illustrates the typical sampling distribution associated with each of the individual types of random sampling.

Different Sampling and Analysis Objectives for Enforcement Agencies and Waste Handlers
“Proving the Positive” versus “Proving the Negative”

For enforcement agencies and waste handlers, the purpose of a sampling and analysis program is to identify chemical constituents and characteristics in waste to adhere to or ensure adherence to regulations. Many RCRA regulations contain concentrations that are not to be exceeded to comply with the standard. Nonetheless, the sampling and analysis conducted by a waste handler can be different from that conducted by enforcement agencies due to a difference in the objectives of each.

When the objective for an enforcement official is to evaluate a waste handler’s compliance with a “do not exceed” standard, the enforcement official will likely initially collect one sample based on professional judgment. The waste handler, however, may want to ensure that waste concentrations are low enough so that it would be highly unlikely that any undivided sample of the waste would exceed a “do not exceed” regulatory standard.

The sampling and analysis objective of the enforcement official is sometimes called “proving the positive.” That is, the enforcement official determines whether a concentration of a specific constituent in some portion of the waste stream exceeds the regulatory level. This only requires a single measurement above the regulatory level to draw such a conclusion, that the waste at least in part exceeds the “do not exceed” regulatory standard. “Proving the positive” usually does not depend on low detection limits or high analyte recoveries. Per Federal Register preamble (see [55 FR 4442, February 8, 1990](#)). It reads:

“If a sample possesses the property of interest, or contains the constituent at a high enough level relative to the regulatory threshold, then the population from which the sample was drawn must also possess the property of interest or contain that constituent.”

The sampling and analysis objectives of a waste handler on the other hand may focus on “proving the negative.” While it is never possible to have complete confidence in a determination, the waste handler may seek to demonstrate with a high level of confidence that the vast majority of the waste is far enough below the regulatory standard so that an additional sample of the waste would be unlikely to exceed the regulatory standard. “Proving the negative” is far more demanding than “proving the positive” and thus encourages proper sampling design and good quality control. Per Federal Register preamble (see [55 FR 4441, February 8, 1990](#)). It reads:

“The sampling strategy for these situations (proving the negative) should be thorough enough to insure that one does not conclude a waste is nonhazardous when, in fact, it is hazardous.”

Therefore, the waste handler may want to establish objectives that focus on “proving the negative.” This is accomplished by using a systematic planning process, designing a WAP based on the objectives, collecting and analyzing the appropriate number of samples, and using the results from the sample analyses for decision-making.

TABLE 2-4: Sampling Approach Overview

Sample Strategy	Definition	Applicability	Advantages/Disadvantages
AUTHORITATIVE	Technique where sample locations are selected based on detailed knowledge of the wastestream without regard to randomization.	Wastestreams of known physical/chemical properties and concentrations.	Requires in-depth knowledge of properties and constituents of wastestreams. Rationale for sample selection should be documented and defensible.
RANDOM (Simple, Stratified, Systematic)	Technique where sample selection and location are determined through the application of statistical methods.	Used to collect representative samples where data is insufficient to justify authoritative sampling (e.g. wastestreams of unknown or variable concentration).	See discussions below for each respective random sampling technique.
<ul style="list-style-type: none"> ▪ Simple Random 	All locations/points in a waste or unit from which a sample can be obtained are identified, and a suitable number of samples are randomly selected.	Used to collect representative samples of wastes that are heterogeneous throughout the entire wastestream or unit (e.g. multiple drums of unknown origin).	<p>Advantages: Most appropriate where little or no information is available concerning the distribution of chemical constituents.</p> <p>Disadvantages: May misrepresent wastestreams with areas of high concentration or stratification.</p>
<ul style="list-style-type: none"> ▪ Stratified Random 	Areas of nonuniform properties or concentrations are identified and stratified (segregated). Subsequently, simple random samples are collected from each stratum of the waste or unit.	Used to collect representative samples from waste or units that are known to have areas of nonuniform properties (strata) or concentration (hot spots) [e.g. surface impoundments with multiple waste layers].	<p>Advantages: Provides for increased accuracy of wastestream representation if strata or a typically high or low concentration area is present.</p> <p>Disadvantages: Requires a greater knowledge of the wastestream relative to waste where simple random sampling is used and may require sophisticated statistical applications.</p>
<ul style="list-style-type: none"> ▪ Systematic Random 	The first sampling point is randomly selected but all subsequent samples are collected at fixed space intervals (e.g. along a transect or time intervals.)	An alternate procedure used to collect representative samples from modestly heterogeneous wastestreams that provides for simplified sample identification.	<p>Advantages: Provides for easier sample identification and collection relative to other techniques.</p> <p>Disadvantages: May misrepresent wastestreams with unknown areas of high concentration or stratification.</p>

FIGURE 2-3: Illustration of Simple Random, Stratified Random and Systematic Random Sampling

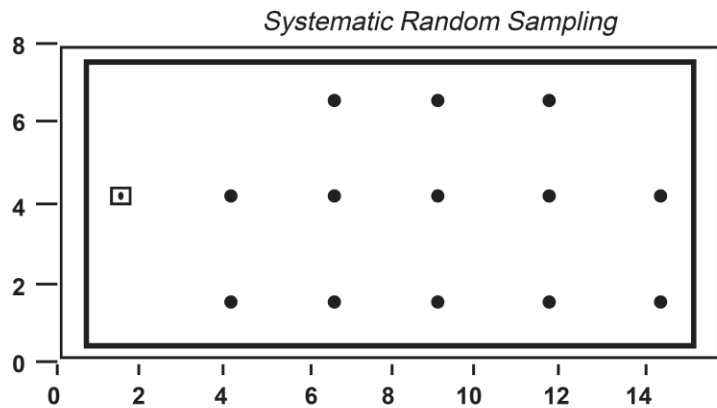
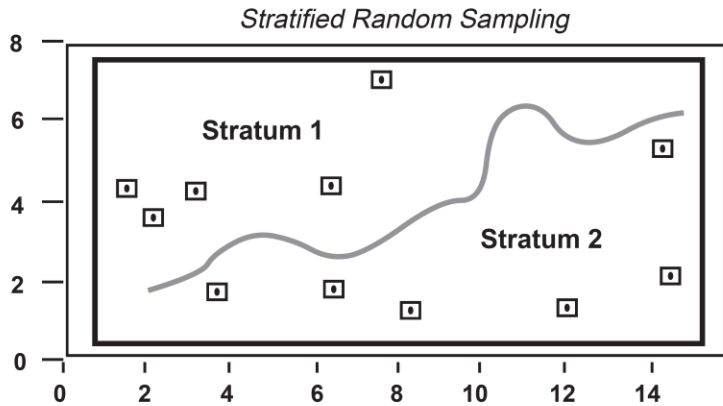
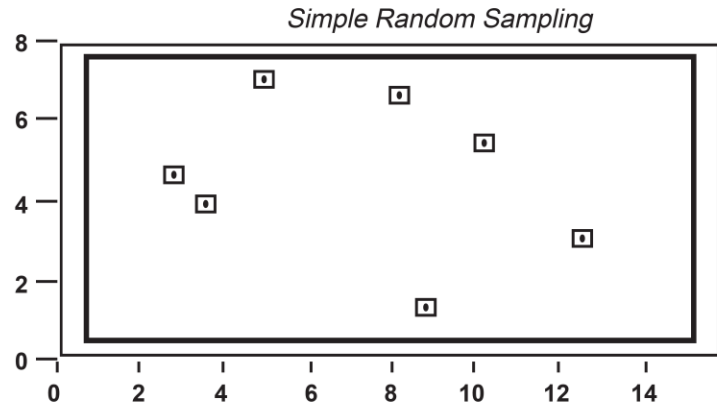

LEGEND:

- Sample Area Boundary
- Strata Boundary
- Randomly Selected Sample Location
- Sample Location Determined Systematically

An additional element in the design of an effective sampling strategy is the selection of appropriate sample types. Based on the analytical objectives of sampling (e.g., initial waste identification versus recharacterization), analytical considerations, and available resources (for sampling and analysis), two basic types, **grab and composite samples**, can be collected, as described in Table 2-5 Major Sample Types.

TABLE 2-5: Major Sample Types

Sample Type	Definition	Applicability	Advantages/Disadvantages
GRAB	A sample taken from a particular location at a distinct point in time.	Most common type used for random sampling. Useful in determining wastestream variability (e.g. range of concentration) when multiple or frequent samples are obtained.	Advantages: Simplest technique, best measure of variability and range of contaminant concentrations. Disadvantages: May require a larger number of samples relative to composite sampling to obtain a representative sample.
COMPOSITE	A number of random samples are initially collected from a waste and combined into a single sample for subsequent analysis.	Used where average or normalized concentration estimates of a wastestream's constituents are desired. <u>Note:</u> If collecting samples for compliance with LDR or UHC treatment standards, you may not be able to collect composite samples. Please check with the regulations before proceeding.	Advantages: Reduces analytical costs. May reduce the number of samples needed to gain accurate representation of a waste. Disadvantages: Only provides the average concentrations of a wastestream (i.e. information about concentration range is lost). <u>Note:</u> You should generally not collect composite samples if you are analyzing for VOCs unless permitted by the regulations, as these compounds can be lost during sample mixing. If you are sampling for parameters in addition to VOCs (e.g., metals), you may composite samples for these other analyses as long as the compositing procedure will not alter the constituents.

A **composite sample** is a number of individual samples called aliquots collected from a volume of waste that are combined into a single sample for analysis. Composite sampling is an attractive option as it can help to reduce costs when used appropriately, and where it is not explicitly prohibited by regulation such as for analysis for universal treatment standards under 40 CFR §268.48(a). A disadvantage of composite sampling is that “hot spot” contaminant concentrations can become diluted. This problem may be alleviated by dividing the action level, for example, the maximum concentration of contaminants for the toxicity characteristic in Table 1 of 40 CFR §261.24, by the number of aliquots comprising the composite sample, resulting in a new lower action level. After this is done, it must be ensured that the analytical detection limit is less than or equal to the newly adjusted (lower) action level. Another factor to be considered when compositing is that the waste being sampled should be relatively homogeneous and that none of the anticipated contaminants are volatile compounds since volatile substances may be lost during homogenization of the aliquots.

Finally, it is very important to ensure that the individual aliquots are all equal in volume before they are combined and homogenized.

A **grab sample** is a single sample from a particular location within a volume of waste at a distinct point in time. Grab samples should generally be collected if the integrity of the sample may be affected by the physical mixing of samples during the compositing process (e.g., volatile constituents), and when determining compliance with the LDR requirements as specified (e.g., compliance with UHCs is measured by an analysis of grab samples unless otherwise noted in the regulations). EPA established treatment standards for wastes based on grab sampling as it reflects maximum process variability, and thus reasonably characterize the range of treatment system performances.

Further information on sampling strategies and the optimum applications for each strategy are included in the following guidance documents, methods, and standards:

- American Society for Testing and Materials, RCRA Waste Management: Planning, Implementation, and Assessment of Sampling Activities, Manual 42, 2000. <http://www.astm.org/BOOKSTORE/PUBS/MNL42.htm>
- US EPA Guidance on Choosing a Sampling Design for Environmental Data Collection for Use in Developing a Quality Assurance Project Plan (EPA QA/G-5S) EPA/240/R-02/005, December 2002. <http://www.epa.gov/quality/qs-docs/g5s-final.pdf>.
- US EPA Observational Economy Series, Volume 1: Composite Sampling, EPA-230-R-95-005, 1995. <http://www.epa.gov/epawaste/hazard/tsd/permit/tsd-regs/wap-refs/comp-samp.pdf>.
- US EPA RCRA Waste Sampling Draft Technical Guidance, EPA 530-D-02-002, 2002. http://www.epa.gov/epawaste/hazard/testmethods/sw846/samp_guid.htm.
 - Chapter 5: Optimizing the Design for Obtaining Data

Grab or Composite Samples?

It is imperative that you understand both the applicable regulations and the intended use of the sample data before determining whether to collect either grab or composite samples.

For example, compliance with the LDR numeric treatment standards for non-wastewaters typically is to be determined using “grab” samples rather than composite samples. Grab samples processed, analyzed, and evaluated individually normally reflect maximum process variability, and thus reasonably characterize the range of treatment system performance. Typically, grab samples are used to evaluate LDR non-wastewaters and composite samples are used to evaluate LDR wastewaters, except when evaluating wastewaters for metals (D004 through D011) for which grab samples are required [40 CFR 268.40(b)].

For additional information, see the following:

- Land Disposal Restrictions for Second Third Scheduled Wastes. [Federal Register 54:120 \(June 23, 1989\). pps. 26605-26606](#). Treatment Standards Based on Single Facility Data and Grab Samples Versus Composite Samples.
- Land Disposal Restrictions for Third Third Scheduled Wastes. [Federal Register 55:106 \(June 1, 1990\). p. 22539](#). Treatment Standards Based on Single Facility Data, Grab Samples Versus Composite Samples, and Waste Analysis Plans.

- Chapter 6: Controlling Variability and Bias in Sampling
- Appendix C: Strategies for Sampling Heterogeneous Wastes
- US EPA Superfund Program Representative Sampling Guidance, Volume 4: Waste, EPA 540-R-95-141, 1995. <http://www.epa.gov/epawaste/hazard/tsd/permit/tsd-regs/wap-refs/superfund-samp.pdf>.
- US EPA SW-846 Test Methods for Evaluating Solid Waste, Physical/Chemical Methods. <http://www.epa.gov/epawaste/hazard/testmethods/sw846/index.htm>.
 - Chapter Nine: Sampling Plan

Sampling Frequencies

The RCRA regulations state that “waste analysis must be repeated as necessary to ensure that it is accurate and up to date.” [CFR §§264/265.13(a)(3)]

At a minimum, the analysis must be repeated as follows:

- When the owner or operator is notified, or has reason to believe, that the process or operation generating the hazardous wastes, or non-hazardous wastes if applicable under § 264/265.113(d), has changed [40 CFR §§264/265.13(a)(3)(i)].
- For off-site facilities, when the results of the inspection (fingerprint analysis) required in paragraph (a)(4) of 264/265.13 indicate that the hazardous waste received at the facility does not match the waste designated on the accompanying manifest or shipping paper. [40 CFR §264/265.13(a)(3)(ii)]. An off-site facility must inspect and, if necessary, analyze each hazardous waste shipment received to determine if it matches the identity of the waste specified on the accompanying manifest or shipping paper. [40 CFR §§264/265.13(a)(4)]

Although there are no required time intervals for re-evaluating wastes, you need to develop a schedule for re-evaluating the waste on a regular basis to ensure the analysis is accurate and up to date [40 CFR §§264/265.13(b)(4)]. You may need to make an individual assessment of how often waste analysis is necessary to ensure compliance with your RCRA permit operating conditions. Off-site combustion facilities may need to characterize all wastes prior to burning to verify that permit conditions will be met (i.e., fingerprint analysis may not be acceptable).

The Cost of Infrequent Analysis

Increasing sampling frequency may result in additional analytical costs. These costs may be minor in comparison to penalties for non-compliance. Consider a situation where a hazardous waste is disposed of as non-hazardous waste and the facility has been sampling the waste annually, a frequency they cannot justify.

Specifically, the facility:

- Analyzes a new wastestream in January and determines that it is nonhazardous.
- Disposes the waste monthly as non-hazardous based on the initial evaluation.
- Re-analyzes the waste in December and finds it contains hazardous levels of cadmium.
- Properly treats and disposes of the December waste based on the cadmium hazard.

The potential consequences:

- The facility may be subject to penalties for improper disposal of the shipments from February through November of that year. The RCRA penalty provisions can be found at 40 CFR 19.
- The facility may be financially responsible for the clean-up of the improperly disposed waste, which may now be blended with and indistinguishable from other wastes in the unit.
- The insurance premiums of the facility may increase.

When the regulations do not specifically stipulate sampling frequency, you may want to use a tiered approach to waste re-evaluation. That is, you may consider conducting a thorough initial characterization of each waste and then slowly reduce the frequency of re-evaluation over time with each subsequent shipment as long as the hazardous constituents are safely below the action level (defined in Section 2.3). **For example, if a site generates a new waste stream during its manufacturing operations, the number of manufacturing batches to sample should be determined through a sound statistical basis and with a thorough understanding of the potential for variability in the waste stream.** This is important, as the waste handler can use the data from this initial shipment as a baseline to evaluate data from the subsequent shipments. There are also a number of ways to use historic waste data to determine re-evaluation frequencies. One possible approach is detailed in Section 2.8. You do not need to use this specific approach but your WAP must state how you will determine re-evaluation frequencies based on waste data.

2.5.2 Selecting Sample Equipment

Four broad criteria relating to waste that should be considered when determining the most appropriate type of sampling equipment to use for a given sampling strategy:

- Physical parameters
- Chemical parameters
- Waste-specific criteria (e.g., oily sludges)
- Site-specific factors (e.g., accessibility issues)

Specific **physical parameters** affecting this selection include:

- Physical State
 - Liquid (free flowing or highly viscous)
 - Solid (crushed, powdered, or whole) or environmental media (soil, sediment)
- Distribution
 - Homogeneous
 - Heterogeneous (stratified/layered, hot spots)

Chemical parameters of the waste can also significantly affect the waste collection effort. The person collecting the sample may need to ensure that the sampling equipment is constructed of materials that are not only compatible with the wastes, but are not susceptible to reactions that might alter or bias the physical or chemical characteristics of the waste. Examples in which the sampling equipment material may potentially yield false analytical results would be the release of organic compounds from certain plastics or of heavy metals (e.g., cadmium, nickel, lead) from metal alloys used in sampling corrosive wastestreams.

Waste- and site-specific factors may also affect the use of sampling devices. Examples of waste-specific properties that may affect the use of common sampling equipment are the collection of oily sludges or highly corrosive wastes. Examples of site-specific situations involving complex sampling activities include the collection of representative samples from waste management units with limited accessibility. In addition to determining the type of sampling equipment used, the waste- and site-specific factors also may require modification of the chosen equipment so that it can be applied to the waste.

Once the physical, chemical, waste- and site-specific factors associated with the wastestream have been identified and evaluated, appropriate sampling equipment can be selected. The equipment most typically used in sampling includes:

- Composite liquid waste samplers (coliwesas), weighted bottles, and dippers for liquid wastestreams
- Triers, thieves, and augers for sampling sludges and solid wastestreams
- Bailers, suction pumps, and positive displacement pumps for sampling wells for groundwater evaluations.

Liquid Samples

A **coliwasa** is most appropriate when sampling free-flowing liquids and slurries in drums, shallow tanks, pits, and similar waste containers. The stream coliwasa consists of a glass or plastic or metal tube equipped with an end closure that the sampler can open and close to initiate and/or stop the sampling while the tool is submerged in the material to be sampled. A **weighted bottle or dipper** may be used to obtain a sample of a free flowing liquid or

slurry from areas with limited accessibility. See Figure 2-4, Samplers for Liquid Wastestreams, for depictions of coliwasa, weighted bottle, and dipper samplers.

Solid Samples

A **thief** is suitable for sampling dry granules or powdered wastes whose particle diameter is less than one-third the width of the slots in the thief. The thief consists of two slotted concentric tubes. The outer tube has a conical pointed tip that allows the thief to penetrate the waste you are sampling. The sampler then rotates the inner tube to a closed position so that a sample can be retrieved from the wastestream. A sampling **trier** is a tube cut in half lengthwise with a sharpened tip that allows penetration of the tube into adhesive solids and allows the sampler to loosen granulated materials. Generally, the trier is 61 to 100 cm long with a diameter between 1.27 and 2.54 cm. It is used to sample solids whose diameter is less than one-half that of the trier. **Augers** are used to sample hard or packed solid wastes and consist of sharpened spiral blades attached to a hard metal central shaft. Augers can be one foot to several feet long. See Figure 2-5, Samplers for Solid Wastestreams, for depictions of thief, trier, and auger samplers.

Table 2-6 Applicability of Sampling Equipment to Wastestreams presents examples of common types of sampling equipment and their applicability for sampling various types of wastestreams. Waste-specific conditions at your facility may indicate that the recommended equipment is inappropriate. Accordingly, it is best to develop a sampling strategy with equipment that is tailored to your site. SW-846, Chapter 9 contains additional guidance on the applicability of sampling equipment for different waste matrices. Alternatively, consult with a knowledgeable EPA representative, a qualified environmental testing laboratory or industry group if you are uncertain as to how to select the appropriate equipment.

TABLE 2-6: Applicability of Sampling Equipment to Wastestreams

Waste Type	Waste Location or Container								
	Drum	Sacks and Bags	Open Bed TRUCK	Closed Bed Truck	Storage Tanks Or Bins	Waste Piles	Ponds, Lagoons, Pits	Conveyor Belt	Pipe
Free-flowing liquids and slurries	Coliwasa	N/A	N/A	Coliwasa	Weighted bottle (a)	N/A	Dipper	N/A	Dipper
Sludges	Trier	N/A	Trier	Trier	Trier	(b)	(b)	(b)	(b)
Moist powders or granules	Trier	Trier	Trier	Trier	Trier	Trier	Trier	Shovel	Dipper
Dry powders or granules	Thief	Thief	Thief	Thief	(b)	Trier	Thief	Shovel	Dipper
Packed Sand or powders and granules	Auger	Auger	Auger	Auger	Thief	Thief	(b)	Dipper	Dipper
Large-grained solids	Large Trier	Large Trier	Large Trier	Large Trier	Large Trier	Large Trier	Large Trier	Trier	Dipper

a When the tank is adequately agitated or a recirculation line is accessible, samples can be collected through a side tap.

b This type of sampling situation can present significant logistical sampling problems, and sampling equipment must be specifically selected or designed based on-site and waste conditions. No general statement about appropriate sampling equipment can be made.

FIGURE 2-4: Samplers for Liquid Wastestreams

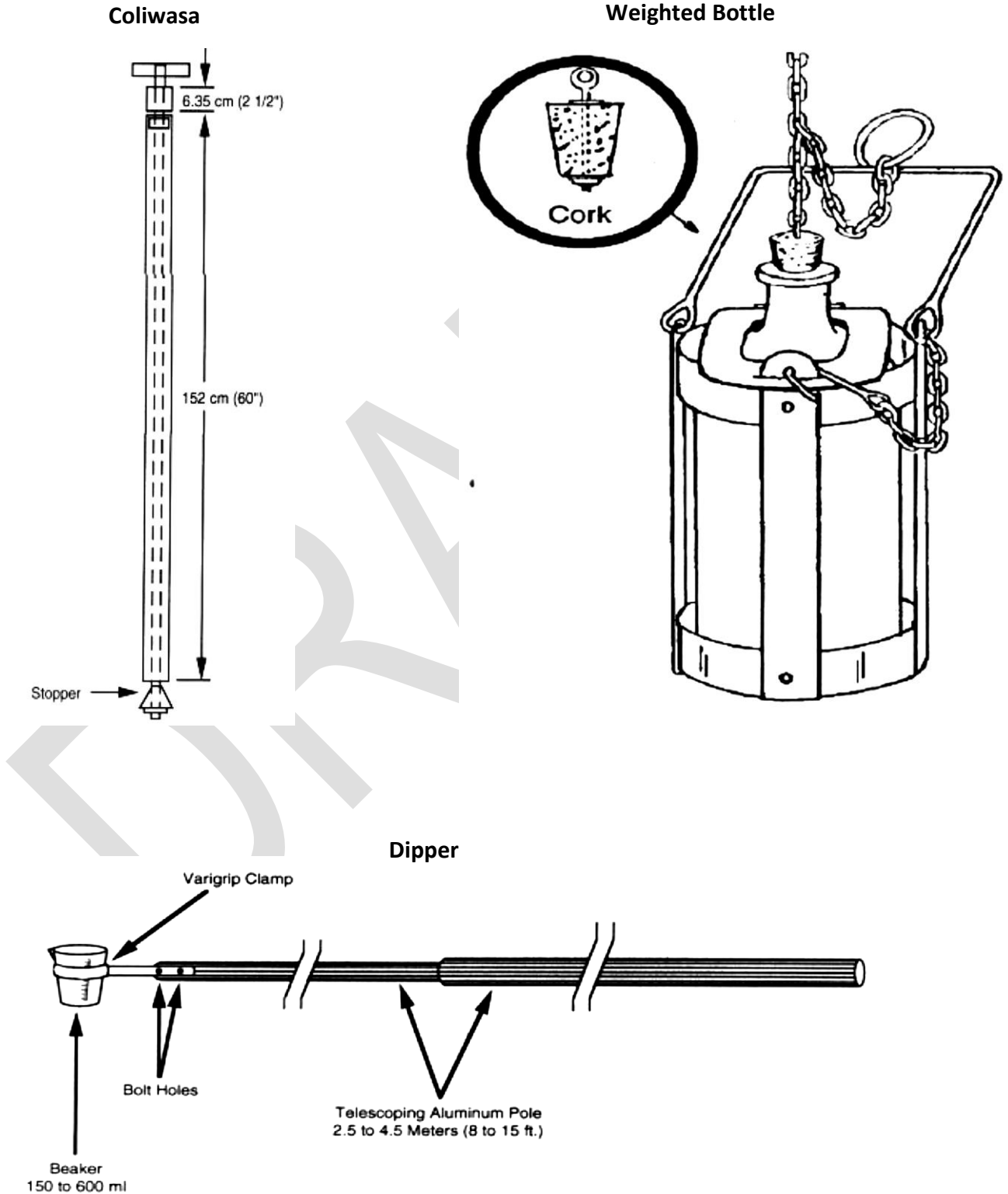
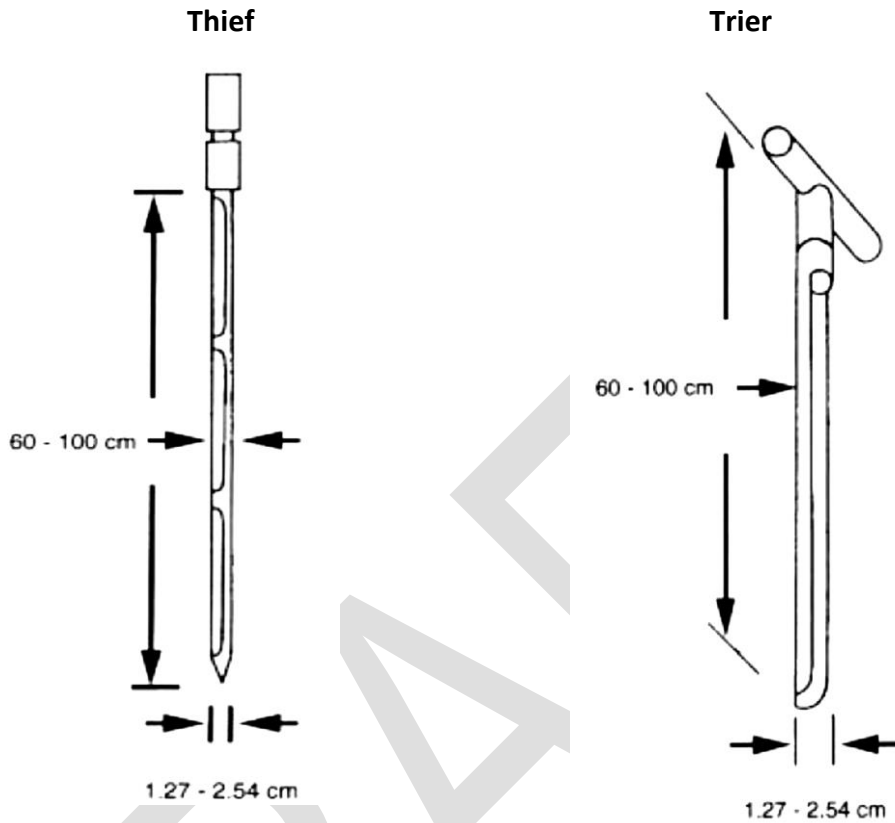
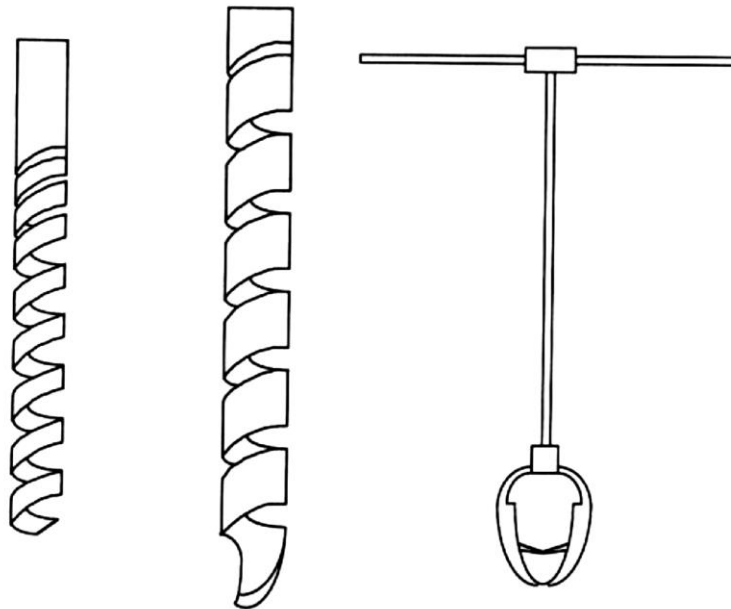

FIGURE 2-5: Samplers for Solid Wastestreams



Hand Augers



2.5.3 Maintaining and Decontaminating Field Equipment

Some analyses, such as pH, can be performed at the facility using field equipment. In order to provide accurate data to ensure data quality, this equipment should be properly maintained and calibrated regularly. The maintenance guidelines set forth in the operator's manual of each piece of equipment may help determine calibration frequency as proper maintenance varies by model manufacturer. At a minimum, the facility may need to inspect and calibrate the equipment prior to use and keep calibration records on file for review.

All equipment that comes in contact with waste needs to be free of residual materials so that it would not influence (i.e., contaminate) the true physical or chemical composition of the waste. Therefore, to minimize the potential for cross-contamination, all equipment and containers should be cleaned thoroughly and decontaminated prior to use. Also, all sampling equipment should be decontaminated after each sampling event. These procedures generally consist of an initial step to remove all loose debris and soil from the sampling equipment, followed by a thorough cleaning process, including washing with an inert detergent solution (such asalconox). As a final step, the equipment is rinsed with an appropriate solvent (e.g., volatile alcohols, acetone, or hexane for organics; nitric acid for inorganics) followed by several rinses with deionized water.

The level of decontamination that is appropriate during and after sampling is dependent upon the degree of contamination and the sensitivity of the analytical tests to be performed. Where materials and equipment are to be reused, proper decontamination procedures should be followed to diminish the potential for cross-contamination of samples. If subsequent storage of the equipment does not preserve the cleanliness of the decontaminated equipment, the equipment should be decontaminated prior to the next sampling event.

Sample containers may be supplied by a laboratory equipment manufacturer or by your analytical laboratory. For manufacturer-supplied containers, a certificate of analysis, or other documentation may be obtained, which describes the contaminant levels inherent to the sample containers. In either case, appropriate quality control measures, as described in subsequent sections, should be taken. Furthermore, used containers that have not been decontaminated generally should be avoided to reduce the potential of cross-contamination.

2.5.4 Sample Preservation and Storage

Once the sample has been collected, sample preservation techniques and holding times, if applicable, need to be employed to ensure that the integrity of the waste remains intact while the samples are in transport to an off-site laboratory and/or while stored at the laboratory prior to analysis. Sample preservation is generally not applicable for highly concentrated samples; however, low concentration samples needs preservation. If a sample is not preserved properly, the constituents of concern in the sample may be chemically, physically, or biologically altered through degradation or other processes (e.g., volatilization, oxidation). Examples of typical sample preservation techniques include:

- Preserving the sample with appropriate chemicals (e.g., adding an acid preservative to suppress biological activity)
- Refrigerating samples
- Storing and shipping samples in the appropriate container and lid type (e.g., collecting samples for light sensitive organic contaminants in amber glass bottles).

Appropriate preservation methods allow samples to be stored without concern for physical or chemical degradation for the time between sample collection and analysis. However, the effectiveness of preservation diminishes over time, thereby potentially affecting the sample's integrity. Accordingly, EPA has established standardized holding times, based upon the chemical constituent of interest to ensure the integrity and validity of resulting analytical data. For a detailed list of proper sample containers preservation techniques, and holding times, if applicable, -ne may refer to SW-846, Chapter 2, or the individual SW-846 methods themselves.

2.5.5 Establishing Quality Assurance/Quality Control Procedures

Quality assurance (QA) is the process for ensuring that all data and the decisions based on that data are technically sound, statistically valid, and properly documented. Quality control (QC) procedures are the tools employed to measure the degree to which these quality assurance objectives are fulfilled. As the first component of data acquisition in relation to waste testing, sampling techniques may need to incorporate rigorous QA/QC procedures to ensure the validity of sampling activities. Since a facility's compliance with applicable permitting and regulatory requirements may be based on a relatively few number of analytical measurements, any event (e.g., unidentified contamination, dilution, improper handling) that may compromise the collection and measurement of a representative sample is significant. Thus, it is important for QA/QC procedures to be established in the WAP and followed. Each facility will likely implement its own QA/QC procedures because each facility will have its own unique QA/QC requirements. Additionally, all persons involved in sampling activities may need to be aware of applicable QA/QC procedures. More detail on what may be needed for QA/QC is provided in SW-846.

Quality Assurance

In many ways, QA can only be measured qualitatively. For example, to assure that samples are taken with the same level of precision each time, QA procedures can be as simple as making sure that the personnel collecting the sample are trained and experienced. Additionally, a chain-of-custody protocol is a useful qualitative tool for documenting the time and location of sample collection activities. The WAP may need to provide facility-specific procedures, including:

- Sample strategy (including type of samples to be collected)
- Sampling identification numbers and locations
- Preservation reagents and techniques, as appropriate
- Chain-of-custody procedures
- Types of sampling equipment and sample containers
- Analytical procedures
- Decontamination procedures
- Field and laboratory QC procedures (see related discussions below)
- Relevant health and safety considerations.

It may be beneficial for facilities to document any deviations from the WAP and the reasons for deviating from WAP procedures.

Quality Control

QC procedures, as tools to measure the attainment of QA objectives, lend themselves to be measured more quantitatively. For example, one QC procedure involves taking samples in duplicate or triplicate and sending them to the analytical laboratory. If the analytical results of the duplicates are similar to the original sample, the original sample is assumed to be precise (i.e., good QA procedures were followed). However, if sample results are highly variable, one could infer that the sample collection procedures are not adequate for collecting a representative sample, or that one or more of the samples collected were inadvertently contaminated. Highly variable analytical results indicate that you may need to re-evaluate the sampling program (to include the collection of more samples), employ a different sampling strategy due to unforeseen or special site conditions, or assess potential for cross-contamination. For more information on precision, bias, accuracy, and representativeness, see the RCRA Waste Sampling Draft Technical Guidance, Planning, Implementation and Assessment, [EPA 530-D-02-002, 2002](#).

QC measures that can be taken throughout the sampling process to ensure the integrity of the overall program include:

Field Blanks are prepared in the field by filling a clean container with pure deionized water and appropriate preservative, if any, for the specific sampling activity being undertaken. If contaminants are found to be present in the field blank, it might be assumed that environmental factors (such as airborne contamination), sampling procedures (causing cross-contamination), or equipment (that is contaminated) were contributing to the levels of hazardous waste constituents that is measured.

Trip Blanks are sample containers that are prepared in the lab using the same type of containers that are to be used for field samples. The containers are filled with an inert material (such as deionized water) that are carried into and out of the field but are not opened at any time during the sampling event. If the trip blanks were found to be contaminated, the source of the contamination would be assumed to be the container itself, the environment in which the trip blank was prepared, or some other source located outside the sample area.

Equipment Blanks are prepared prior to sampling by running pure deionized water over sampling equipment and collecting the water into a clean sample container. If the equipment blank is found to be contaminated, the source of contamination could be assumed to be from the equipment used during the sampling operations.

Field Split Samples are collected by actually splitting a sample volume in half and submitting the samples to two different laboratories. Sometimes, split samples are collected for enforcement purposes. The facility (sampler) splits samples with the regulator as a check on the facility's own analytical program and data recordkeeping. Alternatively, a facility may collect a split sample to verify that the analytical results determined at its on-site facility lab can be verified at an independent laboratory.

Field Duplicates are independent samples that are taken from the same location at the same time and are used to measure the effectiveness of obtaining representative samples. The precision (reproducibility of analytical data) resulting from field duplicates provides an accurate reflection of the variance inherent to the waste composition and the sampling technique. If blanks and duplicates are collected for analysis, they generally should be treated as regular samples, which would include conducting the same preservation and storage techniques, as well as completing the proper paper work (e.g., chain-of-custody documentation) accompanying the samples. The facility should determine, based on its own DQOs, what QC samples to collect, when to collect them, and at what frequency and include a description of this in the WAP to be reviewed and approved by the permitting officials.

Chain-Of-Custody

It may be a good idea to specify chain-of-custody procedures, both internal and external, in the WAP. These procedures involve documentation of the possession of samples from the time they are obtained until they are disposed or shipped off-site for analysis. At a minimum, the procedures should specify the following information when samples of waste or treatment residuals are collected: (1) the type of waste collected, including a brief description and the manifest number, if applicable, and waste code(s); (2) names and signatures of

samplers; (3) sample number, date and time of collection, and designation as a grab or composite sample, including what type of composite sample; (4) names and signatures of any persons involved in transferring samples; and (5) if applicable, the shipping number, such as an airbill number, for samples shipped to off-site laboratories. An example chain-of-custody record is shown on Figure 2-6 Example Chain-of-Custody Record.

2.5.6 Establishing Health and Safety Protocols

Worker safety and health should be taken into consideration when preparing and implementing the WAP at your facility and may need to be part of any personnel training program as required by 40 CFR §§264/265.16. Employees who perform sampling activities should be properly trained with respect to the hazards associated with waste materials, as well as with any sampling and waste handling procedures that will assist in protecting the health and safety of the sampler.

In addition, employees should be trained in the proper protective clothing and equipment that is used when performing sampling activities. Examples of the safety procedures for which personnel at your facility may need to be trained, depending on-site-specific situations include:

- Training in the common routes of exposure (inhalation, contact ingestion) that might be encountered when taking samples.
- Instruction in the proper use of safety equipment, such as Draeger tube air samplers to detect air contamination that employees potentially could be exposed to during sampling.
- Proper use of eye protection, impermeable gloves, protective clothing and footwear, and respiratory equipment to guard against exposure.
- Possible hazards associated with handling and sampling ignitable, corrosive, and reactive waste.

You may want to consult the Occupation Safety and Health Act (OSHA), pursuant to 29 CFR § 1910.120, to determine the required training that may be given to your employees. Additionally, you may also want to consult the *Occupational Safety and Health Guidance Manual for Hazardous Waste Site Activities* (OSHA 1985, revised 1998), which was developed through the joint efforts of OSHA, NIOSH, the US Coast Guard, and EPA to address occupational safety and health issues specific to hazardous waste sites. It is optional whether you include these procedures in your WAP. The inclusion of health and safety procedures, however, enhances the use of the WAP as a hands-on operating tool at your facility.

2.6 Selecting a Laboratory and Laboratory Analytical Methods

2.6.1 Selecting a Laboratory

The use of proper analytical procedures is important in acquiring useful and accurate data. When selecting an analytical laboratory, you may want to consider if the analytical laboratory has demonstrated experience in performing waste sample testing and is capable of providing documentation of their proven analytical capabilities, available instrumentation, and standard operating procedures. Furthermore, you may want to consider selecting a laboratory able to substantiate their data by systematically documenting the steps taken to obtain and validate the data. The following discussion provides guidance on the factors to be considered when selecting an analytical laboratory.

40 CFR 264/265.13 do not require WAPs to address how laboratories will be selected. However, this guidance recommends that the rationale for selecting a laboratory be addressed in the WAP.

The analytical laboratory that demonstrates proficiency in the four major areas below is more likely to provide accurate data:

- Comprehensive QA/QC programs (both qualitative and quantitative)
- Technical analytical expertise
- Effective information management systems
- Third party accreditation

The relevant considerations that may be used to assess laboratory strengths in each of these areas are described in more detail below.

Considerations for the Facility

- Some amount of off-site independent laboratory analysis is important
- Frequent use of laboratory analysis may be preferential instead of relying heavily on generator acceptable knowledge alone
- Learn if your state or federal EPA program has a lab certification program and find a certified lab

Comprehensive QA/QC Programs

Along with sampling activities, a QA/QC program is an integral part of laboratory analytical operations. Laboratory QA ensures that analytical methods generate data that are technically sound, statistically valid, and documented. Individual QC procedures are the tools employed to measure the degree to which these QA objectives are met. Accordingly, you may want to ensure that the laboratory addresses the following program elements.

Qualitative QA/QC Elements

A good laboratory generally will have a laboratory QA plan, sometimes called a quality systems or laboratory quality manual (LQM), which you can request and review. The LQM generally will detail the lab's procedures for important QA elements such as the

organizational structure and management policies, sample handling and tracking procedures, documentation procedures, internal audits, and proficiency testing. Table 2-7 Important QA Elements describes each QA element and what to look for when choosing a lab.

The laboratory will generally also be able to provide you with standard operating procedures (SOPs) for any of the test methods that they perform. This includes having SOPs for SW-846 methods. SW-846 methods contain only general information on how to perform an analytical procedure or technique. They do not detail the specific steps an analyst performs to carry out the procedure. Therefore, a laboratory generally provides this information by generating its own detailed SOP. The one exception to this is SW-846 methods for method-defined parameters (MDPs). An MDP is a regulated parameter or property whereby a particular method is the only one that is capable of measuring the property (e.g., SW-846 Method 1311, the Toxicity Characteristic Leaching Procedure).

On-Site Facility Operated Labs

On-site testing capabilities can be handy to confirm that the physical properties of received waste are the same as the waste profile.

However, EPA strongly discourages facilities from performing anything beyond fingerprint analyses unless they have:

- Comprehensive QA/QC program
- Technical analytical expertise
- Effective information management systems

Seeking third party accreditation may be a useful means of ensuring your on-site laboratory has an adequate QA/QC program.

TABLE 2-7: Important QA Elements

	What to look for...
Organizational structure and management	The lab clearly defines the roles and responsibilities of all personnel.
Sample handling and tracking procedures	The lab explains how samples and sample extracts are processed, identified, stored, and retrieved. This will help to ensure that lab personnel do not mistake one sample for another and analyze your samples within the holding time.
Documentation procedures	The lab has comprehensive documentation procedures for all phases of operation.
Internal audits	The laboratory performs internal audits on a regular basis. During an internal audit, the laboratory will rigorously assess whether their lab is attaining its objectives as stated in the LQM.
Proficiency testing	The laboratory regularly participates in a proficiency-testing program. Proficiency-testing programs give labs a chance to evaluate its analytical performance by testing unknown samples provided by a third party. The lab tests the samples and reports the results to the third party who then compares the lab's results with the actual results (known only to the third party). The lab is then scored based on how they perform.

Quantitative QA/QC Elements

Besides the qualitative measures (e.g., chain-of-custody procedures), quantitative measures may also be used by the laboratory to monitor QA/QC. These measures include analysis of method blanks, duplicates, matrix spikes, and surrogate spikes. Table 2-8 Laboratory QC Techniques presents major QC techniques used by most laboratories to ensure data quality. A well-qualified laboratory will routinely employ these QA/QC procedures to evaluate precision and accuracy of its analytical instrumentation to assess if contamination has occurred, or if other factors exist which could affect data quality.

Technical Analytical Expertise

Laboratories may demonstrate technical analytical expertise by being proficient in using the established EPA analytical methods for hazardous waste determinations and possessing knowledge of any current developments in analytical methods that could affect data quality. To ensure that the required information regarding waste composition is provided, a good laboratory generally will have a working knowledge of the regulatory levels and prescribed analytical methods for routinely analyzed contaminants (e.g., TC constituents).

When selecting an analytical laboratory, you should consider its ability to achieve the **detection limits** (i.e., the lowest level of quantification possible for a given analyte) that you request. Detection limits may need to be adequate to ensure sufficiently low levels of parameter identification to meet prescribed regulatory or permitting thresholds. Laboratories that are equipped with only limited or outdated analytical instrumentation may be incapable of meeting analytical requirements of the regulations.

TABLE 2-8: Laboratory QC Techniques

QC technique	Purpose	Description	Rate
Method Blank	Ensure that any contamination resulting from analytical equipment or process is identified.	Method blanks are artificial samples, usually comprised of distilled deionized water that are submitted to the same laboratory preparation and analytical processes as your samples. If any contaminants are present in this artificial sample after preparation and analysis, it can be inferred that previous samples or laboratory practices caused erroneous or biased results.	Performed at least once each analytical batch with a minimum of once per 20 samples.
Duplicates (Laboratory)	Evaluate the precision of the analytical process.	Two samples of the waste are obtained from one sample container and both are subjected to the same preparation and analysis.	Performed at least once with each analytical batch with a minimum of once per 20 samples.
Matrix Spike	Evaluate the efficiency, accuracy, and precision, of the method being employed to analyze the samples.	Compounds of interest are “spiked” (added) into the samples prior to any preparation methods. The recoveries of the spiked compounds are then used to evaluate the efficiency of the method in detecting the compounds of interest.	Performed at least once with each analytical batch with a minimum of once per 20 samples.
Surrogates Spikes	Evaluate the methods’ efficiency and accuracy.	Organic compounds which resemble the analytes of interest in chemical composition, extraction properties, and chromatographic properties. The recovery of the surrogate spike is used to indicate the effectiveness of the analytical process.	Performed at least once with each analytical batch with a minimum of once per 20 samples.
Laboratory Control Spike or Blank Spike	Evaluate the methods’ efficiency and accuracy.	A sample of known analyte composition and concentration that is used as a benchmark standard.	Performed at least once with each analytical batch with a minimum of once per 20 samples.

Information Management

The laboratory will generally maintain effective information management systems. These systems ensure the availability of all relevant data generated in association with a given sample set (e.g., chain-of-custody records, accuracy and precision information, and analytical results). Additionally, the ability of a laboratory to produce clean and concise analytical reports may be advantageous and help you in maintaining sample documentation. A credible laboratory will generally work with you to tailor its reports to meet your specific requirements. This may be helpful to ensure that you use the information correctly to verify regulatory compliance or evaluate process performance. The laboratory may also be able to provide the information needed to prove data validation

Third-Party Accreditation

Accreditation of environmental laboratories may be a useful indicator in determining if a lab is capable of providing accurate and defensible analytical data. The most common types of environmental laboratory accreditation programs include state programs and the National Environmental Laboratory Accreditation Program (NELAP). NELAP or a state governmental agency can accredit a laboratory if that state is a NELAP recognized Accreditation Body. Additionally, some states have their own laboratory certification programs independent of NELAP. When determining if a laboratory is qualified to perform the testing you need, in addition to the criteria above, it may also be useful to ask if they hold any accreditations. If so, you may inquire what type of accreditation they possess and if the accreditation applies to the methods that you want them to perform. If you are not familiar with the accreditation program, you may want to research the accreditation requirements to determine if the program is rigorous enough.

2.6.2 Selecting Laboratory Analytical Methods

To sustain regulatory and permit compliance, the WAP must specify testing and analytical methods. The selection of an appropriate methodology is dependent upon the following considerations to provide reliable data to ensure safe and effective waste management:

40 CFR 264/265.13(b) (2) require that WAPs address test methods which will be used to test for selected parameters.

- Physical state of the sample (e.g., solid, liquid, or multi-phase)
- Analytes of interest (e.g., volatile organics, metals)
- Data Quality Objectives (e.g., needed detection limits, 1/5 to 1/2 of the regulatory thresholds and precision and accuracy criteria)
- Information requirements (e.g., verify compliance with LDR treatment standards).

Analytical methods consist of two distinct phases -- a preparation phase and a determination phase and for some methods an intermediate step, sample cleanup. The use of an appropriate

combination of preparation, cleanup, and determination procedures may ensure the accuracy of data generated from your facility waste management program.

Preparation Phase

Preparation methods are selected based upon a consideration of the factors presented above and any special requirements associated with the type of analytical determination being performed. These procedures are designed primarily to accomplish one or more of the following:

- Extract the analytes of interest from the sample matrix
- Adjust physical properties (e.g., pH)
- Facilitate chemical conversions necessary for analysis
- Concentrate analytes to allow trace determinations.

Cleanup Phase

Some samples intended for organics analysis that are either highly contaminated or contain extraneous contaminants that are capable of adversely affecting the analysis may require an additional procedure, known as a cleanup step, during sample preparation. These cleanup procedures remove potential interferences from the sample, thereby making it more amenable to subsequent analysis. The most common organic chemical cleanup procedures are florisil column, silica gel column, or gel permeation. The decision to perform a cleanup step usually is made by the analytical laboratory and often involves sophisticated technical judgments concerning sample composition, chemical interactions, and specific analytical limitations. If more information is required on the application of a particular cleanup method, the information can be obtained from SW-846.

Determination Phase

The application of a sample preparation method and, where required, a cleanup step, is accompanied by an appropriate determination procedure specific to the analytes of interest. Analytes are divided into classes (e.g., metals, volatile organic compounds), and for each analytical class, a standard method has been developed to identify and quantify them. For example, organic compounds are typically analyzed by gas chromatography (GC) or gas chromatography-mass spectrometry (GC-MS), while metals are analyzed by atomic absorption spectroscopy (AA), inductively coupled plasma-atomic emission spectroscopy (ICP-AES), and inductively coupled plasma-mass spectrometry (ICP-MS). Due to the number of available preparation and determination options, Figure 2-7 Analytical Method Selection Flowchart is presented to facilitate the selection of the most appropriate preparation and analytical methods to use when performing waste testing. For both inorganic and organic determinations, this figure provides SW-846 methods that may be employed in the analysis of wastes for hazardous constituents (i.e., 40 CFR Part 261, Appendix VIII).

Once you have identified the determinative method(s) for the analytes you want to quantify, you may need to consider the sensitivity of the method. Analytical sensitivity is the smallest concentration of a substance that can be reliably measured by a given analytical method. Analytical sensitivities for the same method and analytes can vary greatly between laboratories and even between different instruments at the same lab with different operating conditions.

It is important to communicate your data needs to your laboratory before having them analyze your samples. The lab may be able to suggest an alternate method of analysis or may be able to make simple changes in the preparation of the sample to achieve the needed sensitivity. In particular, you may want to ask the lab what their detection limits are for the analytes and methods you want them to analyze. The detection limit is the lowest value that a laboratory reports for a given analyte and is a reflection of the analytical sensitivity. For example, if you want to know if your sample contains 5 mg/L (ppm) lead and the lab can only detect to 10 mg/L, the analysis is not sensitive enough to meet your needs. Also, since you rarely have complete confidence that your analytical data are perfect (e.g., due to the non-homogeneity of most wastes, etc.), the detection limits may need to be well below the RCRA regulatory levels. Low detection limits are also helpful when determining the confidence level of your data and calculating re-evaluation frequencies for each wastestream (discussed in Sections 2.7 and 2.8, respectively). Lower detection limits below the regulatory level, may be required to ascertain waste variability and calculate a confidence level.

The Detection Limit

A common measure of laboratory analytical sensitivity is the **detection limit**.

The detection limit is the lowest amount of an analyte that a particular laboratory can determine for a specific method and sample matrix.

A good laboratory will analyze a calibration standard containing the analytes at concentrations equal to the detection limit to demonstrate good recovery at these levels.

FIGURE 2-7: Analytical Methods Selection Flowchart

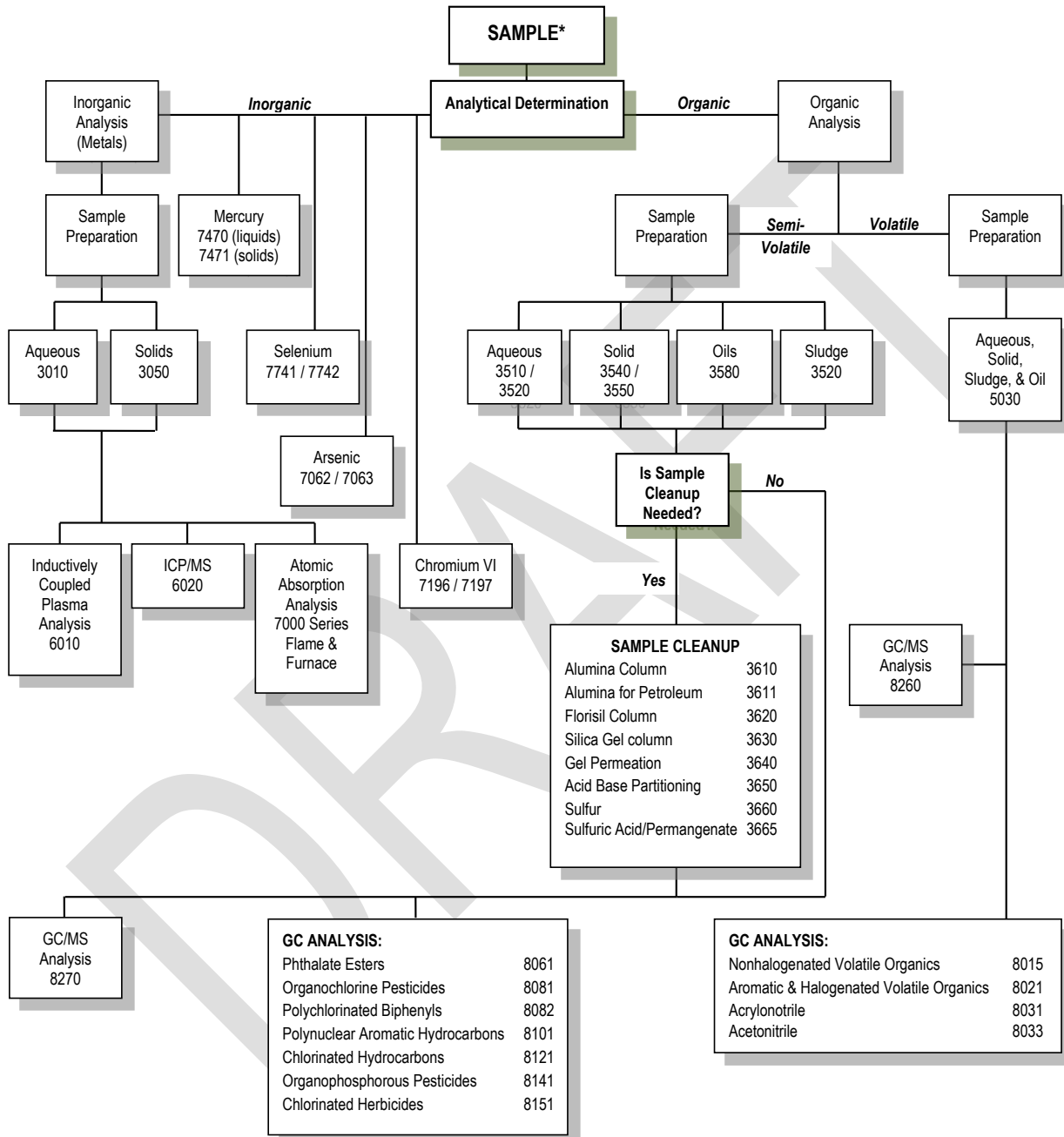

* Sample refers to the actual waste or a leachate of the waste as required TCLP (SW-846 1311).

The methods referenced in the above figure are from SW-846 Test Methods for Evaluating Solid Waste, Physical/Chemical Methods, Update IV. SW-846 methods are updated frequently. Please consult the current SW-846 Online for any subsequent method updates or changes before selecting testing methods. <http://www.epa.gov/osw/hazard/testmethods/sw846/online/>

Data Reporting

The owner/operator of each facility is required to track hazardous waste activity and maintain this information in the operating record until the facility closes. A key component of the operating record is maintaining all waste analytical results. The facility may also want to maintain all information necessary to reconstruct the history of each sample so that the associated data may be understood through the documentation.

This information includes but is not limited to:

- All waste analytical results with the date of analysis, the lab sample ID, and corresponding manifest number clearly identified.
- All associated QC sample results.
- Waste sample tracking information, including internal tracking documentation for samples analyzed on-site and Chain-of-Custody documentation for waste samples sent offsite for analysis.

In addition, for facilities conducting waste testing:

- All raw data for each analysis (e.g., instrument readings and printouts, sample preparation and cleanup protocols, sample weights, etc.).
- Calibration records to include calibration criteria and the frequency at which the calibration is performed.
- Standard operating procedures (SOPs) that accurately reflect current laboratory activities.
- All performance standard and QC samples results and acceptance criteria (e.g., calibration standards, blanks, reference samples, etc.).
- Instrument maintenance and repair records.

2.7 Quantifying Data Uncertainty

As part of the waste analysis process, you use your data to make a decision and determine if the data is capable of supporting that decision. For example, you analyze a waste for organic halogens to determine if it is a candidate for incineration and contains less than 500 ppm of organic halogens. The decision you need to make is whether to incinerate the waste and this is dependent on the organic halogen concentration. At first glance, it would make sense to use 500 ppm as your action level. An action level is simply a value that causes the decision maker to choose between different alternatives. That is, you would decide to incinerate the waste if the organic halogen result is less than 500 ppm but would not if the result is 500 ppm or greater. The problem with this approach is that you rarely have complete confidence that your analytical data are correct due to the non-homogeneity of most wastes and slight differences in how you handle, sample, and analyze the waste. This creates a degree of uncertainty in what seems like a simple yes or no decision. Even when your analytical result is lower than an action level, the uncertainty may result in some possibility that the true concentration in the waste is actually higher than the action level, especially if the analytical result is nearing the action level. This will vary by situation

40 CFR 264/265.13 do not specify the method of quantifying data uncertainty as described in Section 2.7. However, facilities should use methods for quantifying data uncertainty that result in an effective basis for decision-making.

and may need to be determined by considering the consequences for making a wrong decision (e.g., determine a waste is not hazardous when it is hazardous).

For example, the consequences of incinerating waste with elevated levels of organic halogens may be extensive and include potential damage to the incinerator, regulatory penalties for non-compliance, and adverse impacts on public health. Due to the significance of the consequences, you will likely want to minimize uncertainty that the true mean organic halogen concentration is greater than 500 ppm to justify a decision to incinerate the waste even when the analytical results are less than 500 ppm. This may be accomplished by establishing a confidence level for the mean. A confidence level indicates the degree of certainty in the data in terms of a percent. For example, data meeting a 90% confidence level can be interpreted that it is 90% certain (10% uncertain) that the true organic halogen concentration is below 500 ppm. To apply a specific confidence level to your data, you need to determine confidence limits statistically. Confidence limits are the upper and lower limits that your data need to fall within to meet a specific confidence level. Since most action levels will be based on regulatory standards or permitted concentrations/feedrates that must not be exceeded (or equaled), the upper confidence limit is calculated. If all analytical results are below, for example, an upper confidence limit of 90% then you can say that you are 90% certain that the true concentration of organic halogens in the waste is below 500 ppm.

It is easier to demonstrate to regulators that your facility has made a good faith effort to characterize a waste, even if the characterization is found to be in error, if you have statistical estimates with a confidence level of 90% or above (less than a 10% statistical probability of being wrong).

You can determine the 90% confidence limit if your data are normally distributed using the method presented here. **If you do not have normally distributed results, you may still determine confidence limits for your data but you will need to use a different statistical method.** See the example on the next page and consult the references below for additional information.

- US EPA RCRA Waste Sampling Draft Technical Guidance, EPA 530-D-02-002, 2002. http://www.epa.gov/epawaste/hazard/testmethods/sw846/samp_guid.htm
- Calculating Upper Confidence Limits for Exposure Point Concentrations at Hazardous Waste Sites, U.S. Environmental Protection Agency, [OSWER 9285.6-10](#), December 2002.

Calculating the 90% Upper Confidence Limit (UCL) On a Mean

Assume we received the following set of analytical data for the sample discussed above:

Organic Halogen Results

Composite Sample A: 410 ppm

Composite Sample B: 427 ppm

Composite Sample C: 424 ppm

Since the data are normally distributed*, the upper bound of the 90% confidence level may be calculated in the following manner:

STEP 1: Calculate the sample mean:

Where, A, B, and C are the individual sample results and n is the number of sample results.

$$\text{Sample Mean} = (A + B + C)/n$$

$$\text{Sample Mean} = (410 + 427 + 424)/3 = \mathbf{420}$$

STEP 2: Compute the sample standard deviation*:

$$\text{Standard Deviation} = \mathbf{9.07}$$

STEP 3: Use the Critical Values of Student's t Distribution table to look up the value of t*:

$$t \text{ Value} = 1.886$$

STEP 4: Calculate the 90% Upper Confidence Limit:**

$$90\% \text{ UCL} = \text{Sample Mean} + (T \text{ Value} \times \text{Standard Deviation}/\sqrt{n})$$

$$90\% \text{ UCL} = 420 + (1.886 \times 9.07/\sqrt{3}) = \mathbf{429}$$

The upper bound 90% confidence limit of the analytical results (429 ppm) was below the action limit of 500 ppm. The data sufficiently demonstrates that the waste is acceptable for incineration

Note(s):

*For simplicity in the example above, we have used sample results that are normally distributed and have not presented the full calculations for determining the standard deviation calculate or given an explanation of how to look up the "t" value using Critical Values of Student's t Distribution table. If your sample results **are not** normally distributed, you may need to apply different statistical techniques. If you do not know how to calculate the standard deviation or use the t- table, please see the references listed at the end of the section for more information.

** US EPA Office of Emergency and Remedial Response, Calculating Upper Confidence Limits for Exposure Point Concentrations at Hazardous Waste Sites, OSWER 9285.6-10, December 2002.

<http://www.epa.gov/oswer/riskassessment/pdf/ucl.pdf>

2.8 Determining Re-Evaluation Frequencies

As discussed in Section 2.5.1 Sampling Strategies and Sampling Frequencies, RCRA regulations stipulate some specific circumstances when waste should be re-evaluated, including:

- When the owner or operator is notified, or has reason to believe, that the process or operation generating the hazardous wastes, or non-hazardous wastes if applicable under § 264/265.113(d), has changed [40 CFR §§264/265.13(a)(3)(i)].
- For off-site facilities, when the results of the inspection (fingerprint analysis) required in paragraph (a)(4) of 264/265.13 indicate that the hazardous waste received at the facility does not match the waste designated on the accompanying manifest or shipping paper. [40 CFR §264/265.13(a)(3)(ii)]. An off-site facility must inspect and, if necessary, analyze each hazardous waste shipment received to determine if it matches the identity of the waste specified on the accompanying manifest or shipping paper. [40 CFR §§264/265.13(a)(4)]

40 CFR 264/265.13 specify waste re-evaluation frequencies in certain situations. In other situations, waste re-evaluation frequencies are left to owner/operator judgement. Section 2.8 recommends an approach for determining re-evaluation frequencies when owner/operator judgement is needed.

For those wastes that do not fit into the above categories, RCRA simply states, “waste analysis must be repeated as often as necessary to ensure that it is accurate and up to date.” [CFR §§264/265.13(a)(3)]. In your WAP, you should identify how you will determine re-evaluation frequencies to ensure data accuracy.

It may be helpful to take a tiered approach to waste re-evaluation. That is, you may want to conduct a thorough initial characterization of each waste and then slowly reduce the frequency of re-evaluation over time with each subsequent shipment *as long as the hazardous constituents are safely below the action level*. **For example, if a facility generates a new waste stream during its manufacturing process, it may be a good idea to analyze samples from multiple batches during initial characterization of the waste. This could result in a better sense of waste variability.** This is important, as the waste handler may use the data from this initial shipment as a baseline to evaluate data from the subsequent shipments. There are also a number of ways to use historic waste data to determine re-evaluation frequencies. The method described in the paragraph below demonstrates one possible approach. You do not need to use this specific approach but you should state in your WAP how you will determine re-evaluation frequencies based on waste data.

In this example approach, you compare the average of the previous and current waste testing results and then base the re-evaluation frequency on the relative percent difference (RPD) of this value and the action level. This method necessitates that your facility keep accurate data records so that previous data is accessible for comparison to current data. Ideally, you would have access to all data starting from the initial characterization to the present. You might evaluate the data in two ways. First, you might verify that none of the sample results exceed the action level. If the data do not exceed the action level in the initial characterization but did

exceed the action level in the subsequent shipment, you may want to leave the re-evaluation frequency at 100%. Second, assuming the data did not exceed the action level, you could calculate the average of the previous results and calculate the RPD between this value and the action level. Finally, you could determine the re-evaluation frequency based on a fixed schedule like the one used in the examples below and presented in Table 2-9 for shipments of waste received at least monthly:

The following are two examples of how you may want to determine re-evaluation frequencies using historic data for a wastestream.

Determine Re-Evaluation Frequencies Using Historic Data – Example A

Assume that you received the following data from the initial characterization and first re-evaluation of a waste containing toxaphene. Data from the initial characterization and subsequent shipment are provided below:

Initial Characterization Results (1st Shipment)

Batch Average (X1): 0.44 mg/L

Note: No single result exceeded the action level (L) for toxaphene of 0.50 mg/L.

Re-Evaluation Result (2nd Shipment)

Result (X2): 0.40 mg/L

Number of Shipments (n) = 2

Average of Shipments (A):

$$= (X1 + X2)/n$$

$$= (0.44 + 0.40)/2 = 0.42 \text{ mg/L}$$

Relative Percent Difference (Shipment Average and Action Level):

$$= (L-A)/((L+A)/2) \times 100$$

$$= (0.50-0.42)/((0.50+0.42)/2) \times 100 = (0.08/0.46) \times 100 = 17.4\%$$

Re-evaluate the waste quarterly since RPD = 17%

Once quarterly data is collected, recalculate the average using all three sets of data and determine the RPD between the new average and the action level.

Adjust the re-evaluation frequency as needed based on the new RPD.

Please note, it may be advisable to consult a statistician if you are uncertain as to the choice of an appropriate parameter, limit, etc.

TABLE 2-9: Re-Evaluation Frequencies

If the average is:	Then:
Within 10% of the action level (RPD ≤ 10%)	Recharacterize each shipment
Between 10 and 25% of the action level (RPD >10% but ≤ 25%)	Recharacterize quarterly
Between 25 and 50% of the action level (RPD > 25% but ≤ 50%)	Recharacterize semi-annually
Greater than 50% of the action level (RPD > 50%)	Recharacterize annually

Determine Re-Evaluation Frequencies Using Historical Data -Example B

Assume that you received the following data from the initial characterization and subsequent re-evaluations of a waste containing arsenic. Data from the initial characterization and subsequent shipments are provided below:

Initial Characterization Results (1st Shipment)

Average of Batch Results (X1): 4.7 mg/L

Note: No single result was above the action level (L) of 5.0 mg/L

Re-Evaluation Result (2nd Shipment)

Result (X2): 4.8 mg/L

Re-Evaluation Result (3rd Shipment)

Result (X3): 4.3 mg/L

Number of Shipments (n) = 3

Average of Shipments (A):

$$= (X1 + X2 + X3)/n$$

$$= (4.7 + 4.8 + 4.3)/3 = 4.6 \text{ mg/L}$$

Relative Percent Difference (Shipment Average and Action Level):

$$= (L-A)/((L+A)/2) \times 100$$

$$= (5.0 - 4.6)/((5.0 + 4.6)/2) \times 100 = (0.4/4.8) \times 100 = 8\%$$

Re-evaluate each shipment, as RPD is 8%

Once data for the next shipment is collected, recalculate the average using all four sets of data and determine the RPD between the new average and the action level.

Adjust the re-evaluation frequency as needed based on the new RPD.

Please note, it may be advisable to consult a statistician if you are uncertain as to the choice of an appropriate parameter, limit, etc.

2.9 Special Procedural Requirements

2.9.1 Procedures for Receiving Wastes Generated Off-Site

Off-site hazardous waste management facilities may be required to comply with regulations regarding screening and analysis to ensure that the facility does not accept incorrectly identified or unacceptable waste shipments. The off-site facility's WAP must specify the waste analysis data that the generator of the waste shall provide to substantiate its waste determination [40 CFR §§264/265.13(c)]. It is important the WAP include descriptions of the procedures to be taken by the TSDf to determine how well the generator's data represents the wastes to be managed. Based on the results of the assessment, the TSDf should determine whether recharacterization of the waste is necessary if a shipment of a particular waste is determined, for example, through pre-acceptance screening, to be significantly different from the waste as characterized and identified from the pre-shipment sample and/or waste manifest. These procedures and waste recharacterization procedures must be specified in the WAP [40 CFR §§264/265.13(c)]. Alternatively, the owner/operator may reject the entire shipment of waste and return the waste to the generating facility.

40 CFR 264/265.13(c) require WAPs to specify procedures which will be used to inspect and, if necessary, analyze each movement of hazardous waste received at the facility to ensure that it matches the manifest. Sections 2.9.1 and 2.9.2 address some of these procedures, as specified.

An off-site facility may be required, at a minimum, to visually inspect and compare the contents of each shipment to the accompanying manifest to identify the wastes. The shipment received on-site may need to be sampled and analyzed to the extent necessary to verify that it meets permit specifications and regulatory requirements. Some off-site facilities accomplish this by performing a systematic process of screening and analysis that allows for monitoring key indicator parameters. In some cases, however, more stringent waste analysis may be required. Figure 2-8 Shipment Screening provides a methodology that can be used to screen waste shipments.

Shipment screening is especially important for off-site facilities given the variety of wastes typically managed. The level of screening that may be required for an off-site facility is a function of the facility operator's knowledge about the generation process. Therefore, it may be advantageous for off-site facilities to obtain from the generator detailed information regarding:

- The process that generates the waste
- The physical and chemical description of the waste
- The analytical procedures and results used to characterize the waste or acceptable knowledge documentation
- EPA hazardous waste codes
- Certifications and notifications as applicable to LDR wastes.

As discussed in Section 1.1, as a pre-acceptance procedure, most commercial TSDFs obtain this information from the generator in the form of a Waste Profile Sheet (WPS). An example of a WPS is provided in Figure 2-9 at the end of Part Two.

FIGURE 2-8: Shipment Screening

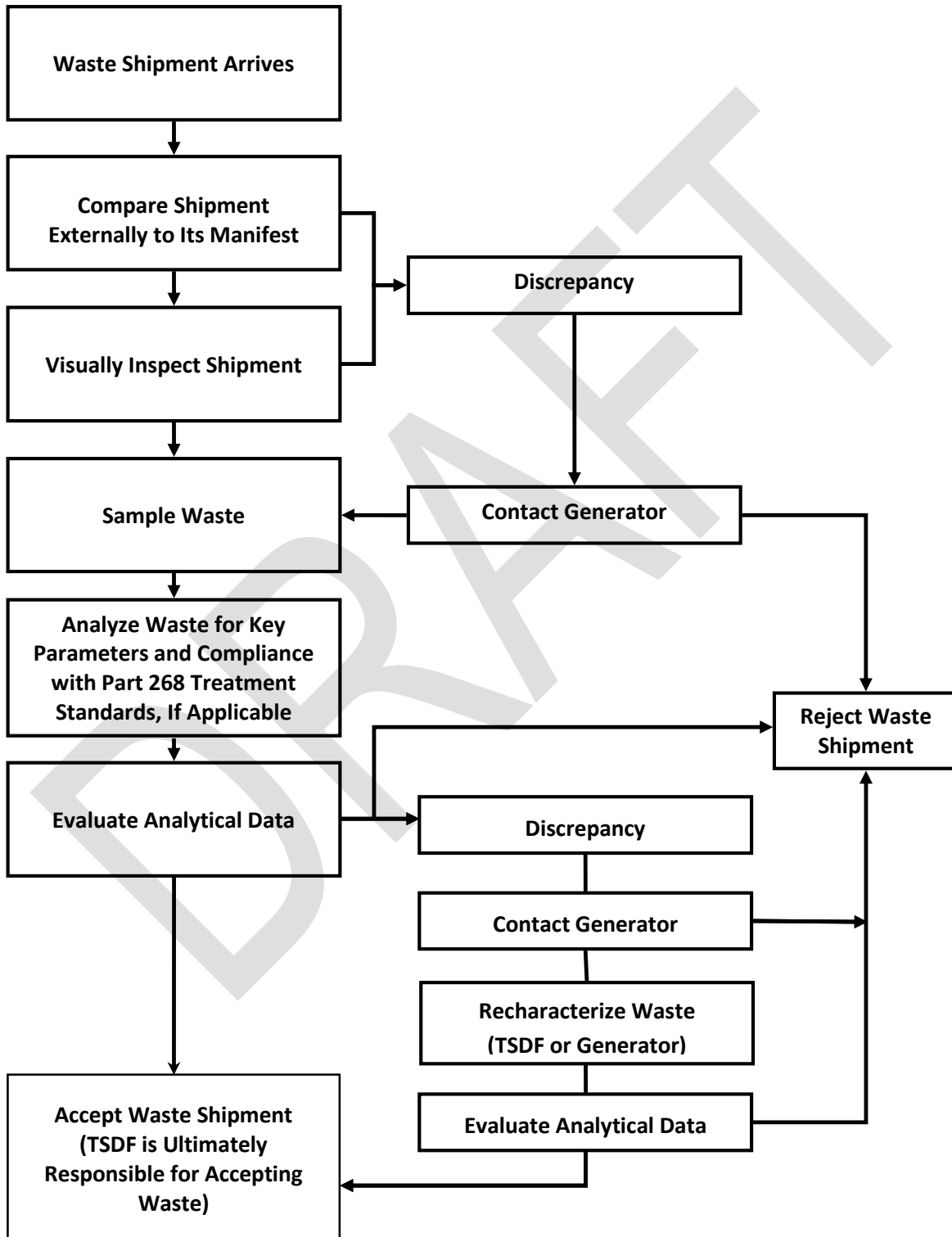

The off-site facility may want to develop procedures for conducting full waste recharacterization if the waste received is significantly different from the waste characterized and identified during pre-acceptance procedures. These procedures for waste recharacterization should be detailed in the WAP. Alternatively, the owner/operator of the off-site facility may reject the entire shipment and send the waste back to the generator.

2.9.2 Procedures for Combustion Facilities

As discussed in Section 2.4.4 (Hazardous Waste Combustion), hazardous waste incinerators, cement kilns, lightweight aggregate kilns, boilers, and hydrochloric acid production furnaces are subject to applicable regulatory requirements pursuant to both the RCRA hazardous waste program and the CAA NESHAP program. A RCRA WAP continues to be a required component of the RCRA permit for these HWCs; however, the combustor-specific feedstream analysis requirements that ensure compliance with the CAA HWC NESHAP emission standards and (feedstream related) operating requirements are found in the feedstream analysis plan (FAP) and now reside in the CAA HWC NESHAP (40 CFR Part 63 subpart EEE). There may be limited cases where a RCRA WAP continues to contain combustor-specific feedstream analysis requirements,¹⁴ but for many HWCs, the RCRA WAP and the CAA HWC NESHAP FAP (or CAA FAP) are maintained as separate documents in separate programs. This does not imply however, that the two documents are exclusive of one another.

Specific to HWCs, the RCRA WAP serves to, among other things, identify the incoming waste and screen out wastes that are prohibited (e.g. metal-bearing wastes prohibited from dilution per Appendix XI to 40 CFR Part 268, radioactive wastes, reactive/explosive wastes, etc.) from going to the combustion unit. The CAA FAP focuses on the waste before being fed to the combustor to ensure that the feedstream is adequately characterized and the concentration of feedrate-limited pollutants (e.g., chlorine) in the feedstream are known. This allows for corrective action to be taken if monitored emissions are approaching non-compliance with CAA HWC NESHAP emission standards and other feedstream related operating requirements. Thus, the CAA FAP can be thought of as a subset of the RCRA WAP, since the incoming waste affects what is ultimately combusted. The key point is that the RCRA WAP and the CAA FAP should complement one another to ensure safe handling of the waste and the efficient operation of the HWC.

State and EPA Regional offices vary in organizational structure and program responsibility for implementing the CAA HWC NESHAP. The potential for regulatory overlap, or even oversight, for HWCs exists due, in part, to applicable requirements under both RCRA and the CAA. This can be especially true for the RCRA WAP and CAA FAP requirements. It is important to emphasize that, in most cases, it is not appropriate for the RCRA WAP to simply reference the

¹⁴ A RCRA WAP may retain some of the combustor-specific feedstream analysis requirements where: (1) pursuant to RCRA omnibus authority, the RCRA permit writer required emission and (emission related) operating requirements that are more stringent than the CAA MACT requirements (such as a limitation on mercury emissions and feedrate); or (2) a HWC elects to comply with one of the RCRA options in 40 CFR §270.235 for startup, shutdown, and malfunction; or (3) area source boilers and HCl production furnaces elect to comply with certain RCRA emission standards in lieu of the full suite of MACT standards.

CAA FAP requirements, and not include details in its RCRA WAP regarding the waste analysis requirements used to ensure compliance with the RCRA requirements or for the CAA FAP to simply reference the RCRA WAP requirements and not include details in its CAA FAP about feedstream analysis requirements used to ensure compliance with the CAA requirements. **Each program has its own set of regulatory requirements for waste analysis that are applicable to HWCs.** In some cases, a permit authority and HWC may agree to combine the RCRA WAP and the CAA FAP requirements into one document. This may be preferred when, for example, the RCRA program has retained authority for reviewing and determining compliance with the CAA HWC NESHAP. Regardless of the approach taken, it is encouraged for permit officials from both programs, along with their HWC facilities, to work together to coordinate the RCRA WAP and CAA FAP requirements. (See the discussion of hazardous waste combustors in Appendix D of this manual for a crosswalk table which highlights the similarities between the RCRA WAP and CAA FAP and identifies sections of this manual that may be of assistance in developing a CAA FAP.)

With respect to the CAA FAP, the regulatory requirements are at 40 CFR §63.1209(c). This section currently states that:

(c) *Analysis of feedstreams*—(1) *General*. Prior to feeding the material, you must obtain an analysis of each feedstream that is sufficient to document compliance with the applicable feedrate limits provided by this section.

(2) *Feedstream analysis plan*. You must develop and implement a feedstream analysis plan and record it in the operating record. The plan must specify at a minimum:

(i) The parameters for which you will analyze each feedstream to ensure compliance with the operating parameter limits of this section;

(ii) Whether you will obtain the analysis by performing sampling and analysis or by other methods, such as using analytical information obtained from others or using other published or documented data or information;

(iii) How you will use the analysis to document compliance with applicable feedrate limits (e.g., if you blend hazardous wastes and obtain analyses of the wastes prior to blending but not of the blended, as-fired, waste, the plan must describe how you will determine the pertinent parameters of the blended waste);

(iv) The test methods which you will use to obtain the analyses;

(v) The sampling method which you will use to obtain a representative sample of each feedstream to be analyzed using sampling methods described in appendix IX, part 266 of this chapter, or an equivalent method; and

(vi) The frequency with which you will review or repeat the initial analysis of the feedstream to ensure that the analysis is accurate and up to date.

(3) *Review and approval of analysis plan*. You must submit the feedstream analysis plan to the Administrator for review and approval, if requested.

(4) *Compliance with feedrate limits*. To comply with the applicable feedrate limits of this section, you must monitor and record feedrates as follows:

(i) Determine and record the value of the parameter for each feedstream by sampling and analysis or other method;

(ii) Determine and record the mass or volume flowrate of each feedstream by a CMS. If you determine flowrate of a feedstream by volume, you must determine and record the density of the feedstream by sampling and analysis (unless you report the constituent concentration in units of weight per unit volume (e.g., mg/l)); and

(iii) Calculate and record the mass feedrate of the parameter per unit time.

(5) *Waiver of monitoring of constituents in certain feedstreams*. You are not required to monitor levels of metals or chlorine in the following feedstreams to document compliance with the feedrate limits under this section provided that you document in the comprehensive performance test plan the

expected levels of the constituent in the feedstream and account for those assumed feedrate levels in documenting compliance with feedrate limits: natural gas, process air, and feedstreams from vapor recovery systems.

To summarize, feedstream sampling and analysis protocols (e.g., sampling frequency, sample size, sample analytical procedure and analytical constituents) that are used to comply with applicable feedrate limits must be outlined in detail in the HWC's CAA FAP and recorded in the operating record.¹⁵ These characterization protocols are site-specific and waste-specific.

Despite the fact that the regulatory requirements for sampling and analysis of the combustion unit feedstream are primarily under the CAA HWC NESHAP, many of the concepts in this guidance can be useful and applied as needed to both the RCRA WAP and CAA FAP for a HWC. One example is sampling frequency. The regulatory requirement under the CAA HWC NESHAP at 40 CFR §63.1209(c)(2)(vi) is nearly identical to the requirement under RCRA at 40 CFR §264.13. Therefore, the regulated community and permit officials may wish to review the discussion in this guidance to assist in determining how often a HWC feedstream should be sampled and analyzed.

Determination of feedstream sampling frequency may depend on considerations such as: (1) trends in historical waste data (waste variability); (2) confidence and extent of knowledge of process; (3) potential for changes in waste composition; (4) expected hazardous air pollutant (HAP) levels in the feedstream; and so forth. **Periodic sampling is required for all feedstreams to ensure the analysis is accurate and up to date, however, the actual frequency will be site-specific.**

Characterization of waste streams based on process/acceptable knowledge may be permitted on a site-specific basis when it can be demonstrated that knowledge is sufficiently accurate to ensure: (1) the waste can be safely handled at the treatment facility; and (2) the treatment facility is complying with its applicable feedrate and emission limitations.¹⁶ For well-known and well-characterized wastes that exhibit little historical variation in composition, the sampling and analysis frequency would be lower. "One-time only" sampling and analysis likely would be appropriate only for very select cases. An example would be where the composition of the waste is very well known and/or changes in waste composition are not possible. Even in such cases, procedures should be in place to monitor for changes in composition.

In cases where it is dangerous, impractical, or unnecessary to use direct sampling and analysis, characterization based on acceptable knowledge should be used to the fullest extent possible. Materials that are considered dangerous can pose extraordinary health, safety or environmental hazards. Examples of dangerous materials can include those that are extremely toxic or reactive, sharps, and biological wastes. It can also be impractical and/or unnecessary to directly sample, or obtain a representative sample of the waste because of the physical nature of the waste, or because the composition of the wastes are known.

¹⁵ Again, it may be possible to combine both RCRA WAP and CAA FAP requirements into one document. However, the FAP requirements must be recorded in the HWC's operating record.

¹⁶ Process/acceptable knowledge can encompass a variety of sources such as analytical information, product label information, safety data sheets, and manufacturer information.

Examples of impractical (or unnecessary) materials can include lab packs and lab wastes, “RCRA” empty used containers, cylinders, aerosols, household hazardous wastes, mixed pharmaceuticals, and unused commercial products/chemicals.

Use of acceptable knowledge alone is not always appropriate, however. This is especially the situation for waste streams that come from multiple generators. These waste streams tend to be highly variable and are received by off-site or commercial HWCs. Analyses of representative samples are necessary to generate a detailed profile of the chemical and physical characteristics of the waste for compliance with applicable feedrate limits. Therefore, the frequency of analysis is often higher at off-site HWCs relative to on-site HWCs who can often rely on acceptable knowledge and minimal sampling and analysis.

As discussed earlier in this guidance (Section 2.4 Selecting Waste Analysis Parameters), the selection of parameters is important in determining what can be safely managed while maintaining regulatory and permit compliance. Specific to HWCs, the selection of parameters to be analyzed in the combustor feedstream will vary according to the type of HWC, alternate mode(s) of operation, and the wastes received. Parameters for HWCs can include ash content, total chlorine, mercury, total metals (combination of semi-volatile and low-volatile metals), heat of combustion, and total halogen. A typical feedstream analysis scenario may include a prequalification analysis (prior to processing), a fuel blending analysis (to inform fuel blending decisions), and batch analysis (representative samples of blended waste for each burn tank or batch).

The sampling frequency and selection of parameters for analysis discussions are two examples in which this guidance can be of assistance to permit officials from both the RCRA and CAA programs, as well as the regulated community when developing a HWC RCRA WAP and CAA FAP. Again, readers may refer to Appendix D for a crosswalk table illustrating the similarities between the RCRA WAP and CAA FAP requirements.

2.9.3 Procedures for Ignitable, Reactive, and Incompatible Waste

WAPs for all facilities must include provisions to ensure that waste management units meet the special requirements for ignitable, reactive, and incompatible wastes [40 CFR §§264/265.17]. Incompatible wastes, if brought together, may result in heat generation, toxic gas generation, and/or explosions. Therefore, a WAP must address measures to identify potentially ignitable, reactive, and incompatible wastes. The information provided by the waste manifest and fingerprint testing can be supplemented with other testing to identify incompatible wastes. Standard tests to identify ignitable, corrosive, and toxic wastes are contained in Chapter 8 of SW-846. You should identify reactive wastes as such if they exhibit at least one of the eight properties identified in 40 CFR § 261.23. As EPA does not currently have a set of approved methods for determining reactivity, generators

40 CFR 264/265.13(b)(6) require WAPs, where applicable, to specify the methods that will be used to meet the waste analysis requirements for ignitable, reactive, and incompatible waste at §§264/265.17.

will need to use waste acceptable knowledge to determine if their waste exhibits the characteristic of reactivity. Finally, waste compatibility determinations can serve to establish compatibility between wastes of interest for a given process. An EPA document, “A Method of Determining the Compatibility of Hazardous Wastes” (EPA-600/2-80-076) [This document can be obtained from the National Technical Information Service (NTIS) (Document No. PB-80221005)] contains procedures to evaluate qualitatively the compatibility of various categories of wastes.

2.9.4 Procedures for Complying with LDR Requirements

Generators and TSDFs have special waste analysis requirements under the LDR program. Regulations in 40 CFR §268.7 require generators and TSDFs to conduct waste analysis to determine the regulatory status of wastes with respect to the treatment standards in 40 CFR Part 268, Subpart D. Generally, hazardous wastes must meet applicable treatment standards prior to land disposal. These treatment standards are expressed in two ways: as constituent concentrations in the waste (either an extract of the waste as determined by the TCLP, or in the total volume of the waste referred to as a total waste analysis) or as specified treatment technologies. Wastes with concentration-based treatment standards must be evaluated to determine if applicable constituent concentration levels have been attained. This can be accomplished by applying waste analysis procedures as either (1) testing the waste, or (2) using knowledge of the process or materials used to produce the waste (for generators only). For acceptable knowledge, this knowledge should be supplemented with analytical data on the regulated constituents.

40 CFR 264/265.13(b)(6) require WAPs, where applicable, to specify the methods that will be used to meet the waste analysis requirements for the LDR program at §268.7.

For treatment standards expressed as concentrations in the waste extract [40 CFR §§268.40], the TCLP (EPA SW-846 Method 1311) must be employed, except as noted in the rules, to obtain an extract of the waste [there are certain exceptions where Method 1310, the Extraction Procedure Toxicity Test, can be used as an alternative for certain arsenic- and lead-containing waste codes listed in 40 CFR §268.40(a)]. The extract will then be tested subsequently for the specific constituents associated with the treatment standard. Treatment standards based on total waste concentrations in 40 CFR §268.40 should use an appropriate total waste analysis procedure for its respective constituents. Please note that many wastes have treatment standards expressed as both extract concentrations and total waste concentrations.

For wastes with treatment standards expressed as specified technologies in 40 CFR §268.42, and for hazardous debris treated to meet the alternative debris treatment standards in 40 CFR §268.45, verification through analysis is not necessary. Instead, compliance with these treatment standards should be documented in the facility operating record to verify that the appropriate treatment technologies have been employed prior to land disposal.

2.10 Discrepancy Policy

Two types of discrepancies that can arise during waste acceptance include 1) manifest discrepancies and 2) discrepancies between the incoming waste shipment and its profile. Therefore, it may be a good idea for the facility to state its discrepancy policy and include detailed procedures in the WAP for handling both types of discrepancies promptly and effectively. Discrepancies generally indicate that an error has occurred in analyzing and/or describing the waste and that corrective and preventative action measures may be needed to prevent its re-occurrence. Facility personnel may also need to decide whether to accept or reject the waste. Because of this, it is advisable for the facility's discrepancy policy to be coordinated with its rejection policy discussed in Section 2.11.

40 CFR 264/265.13 do not require WAPs to include discrepancy policies or procedures. However, this guidance recommends that such policies and procedures be established and described in the WAP since not addressing them could lead to safety issues and noncompliance with permit requirements for waste acceptance.

2.10.1 Manifest Discrepancies

40 CFR §§264/265.72 defines manifest discrepancies as:

- Significant differences between the quantity or type of hazardous waste designated on the manifest or shipping paper, and the quantity and type of hazardous waste a facility actually receives. Significant differences in quantity are, for bulk waste, variations greater than 10 percent in weight, for batch waste, any variation in piece count, such as a discrepancy of one drum in a truckload. Significant differences in type are obvious differences, which can be discovered by inspection or waste analysis, such as waste solvent, substituted for waste acid, or toxic constituents not reported on the manifest or shipping paper.
- Rejected wastes, which may be a full or partial shipment of hazardous waste that the TSDF cannot accept; or
- Container residues, which are residues that exceed the quantity limits for "empty" containers set forth in 40 CFR §261.7(b).

The facility's policies should be consistent with the requirements of 40 CFR §§264/265.72, as applicable. For example, upon discovering a significant difference in quantity or type, the facility may need to attempt to reconcile the discrepancy with the waste generator or transporter (e.g., with telephone conversations). If the discrepancy is not resolved within 15 days after receiving the waste, the facility must immediately submit to EPA or the authorized state a letter describing the discrepancy and attempts to reconcile it, and a copy of the manifest or shipping paper at issue.

The facility needs to decide if the waste can be accepted despite the discrepancy. This involves a determination whether the facility can manage the waste on-site in a manner that

is safe, effective and in accordance with the provisions of its permit. If the waste cannot be accepted, the facility may need to reject it in accordance with its rejection policy.

In addition, the facility may need to evaluate whether the manifest discrepancy reflects a deeper issue than simply a clerical error (e.g., has the generator's waste changed since pre-acceptance?). If a deeper problem is suspected, the facility may need to re-evaluate the waste profile to determine if a new or revised profile is necessary. This could involve sending the waste profile to the generator for re-evaluation and re-certification. For these deeper issues, the generator may need to prepare a corrective action plan describing the issue and how it will be prevented in the future. The facility may also want to maintain records of each manifest discrepancy.

2.10.2 Discrepancies Between Incoming Waste and Profile

As discussed elsewhere in this guidance (e.g., Section 1.2), the facility may need to closely compare each incoming waste to its waste profile to ensure it is receiving the waste that had originally been approved during pre-acceptance. It is common for a generator's commercial processes to change, thereby resulting in a new or modified waste stream. New wastes, as well as modified waste streams that no longer meet the waste profile, may need to be subject to pre-acceptance, so that the facility can consider whether it can manage the waste safely and effectively.

Some Consideration for the Facility

The facility may need to perform a "discrepancy review" whenever the waste acceptance testing shows an unacceptably high variance (trigger level to be negotiated with the permit agency) from the waste profile data (e.g., for BTU value, require a discrepancy review if the Btu value varies more than 15%).

During acceptance, facility personnel may need to perform visual inspections of opened containers (e.g., to confirm basic physical properties, such as color and waste form) and chemical screenings as necessary to determine if new and/or modified wastes have been shipped to their facility. The chemical screenings may need to include one or more parameters with a tolerance limit (e.g., pH limits). A discrepancy occurs if the waste falls outside the range or otherwise does not match other aspects of its profile.

The facility's policy on discrepancies may also need to detail the facility's actions for addressing it. For example, the facility may need to attempt to resolve the discrepancy by calling the generator and requesting additional information. The facility will need to decide whether to accept or reject the waste despite the discrepancy. This involves a determination whether the facility can manage the waste on-site in a manner that is safe, effective and in accordance with the provisions of its permit. The policy may also need to indicate how long the waste will be kept on-site pending a decision (unlike manifest discrepancies, the federal regulations do not specify a time limit for discrepancies related to waste profiles).

If a decision is made to reject the waste, the facility would then follow the procedures of its rejection policy. If the waste is not rejected and the discrepancy cannot be resolved, the facility may want to perform a comprehensive analysis of the waste. The results will help to determine if it is a new or modified waste. If it is newly generated or modified, a

new or revised waste profile may be needed. In all cases, the generator may need to be asked to submit a corrective action plan that describes the reason for the discrepancy and actions to be taken to prevent re-occurrence. The facility should maintain records of each discrepancy.

2.11 Rejection Policy

It may be advisable for a facility to have a rejection policy that is closely coordinated with its discrepancy policy because some discrepancies may lead to rejection. The policy also should ensure that all applicable federal and state requirements for rejections (e.g., 40 CFR §264.72) are followed. For example, the policy should specify that the facility will obtain or confirm the generator's directions on where to forward the rejected waste or residue (i.e., either back to the generator or to an alternative TSDF). While the shipment is waiting to be returned or sent to another TSDF, the facility should ensure that it is properly stored in a secure manner. This could include, for example, storing the waste in a fenced area with drainage and protection from weather. The facility must send the rejected waste or residue off-site within 60 days (as required for manifest discrepancies). The facility must ensure that the rejected load or residue is re-manifested in accordance with applicable manifest provisions. The facility should maintain records of each rejection (e.g., reason for rejection and disposition of the waste).

40 CFR 264/265.13 do not require WAPs to include rejection policies or procedures. However, this guidance recommends that such policies and procedures be established and described in the WAP since not having a policy in place may lead to potential safety issues.

2.12 Recordkeeping

Recordkeeping is an essential aspect of waste analysis, as it documents whether the analyses were done in accordance with required and acceptable procedures. In addition, the analytical results can be used to determine compliance with federal and state requirements (e.g., LDR treatment, if applicable) as well as ensure safe and effective management of the waste. Therefore, the facility may need to develop a well-organized system for recordkeeping that provides the easiest, most straightforward way for addressing these objectives.

40 CFR 264/265.13 do not require WAPs to address recordkeeping. However, this guidance recommends that recordkeeping related to waste analyses and evaluations be addressed in the WAP because it may help to determine compliance with regulatory or permit requirements.

Because of the volume and frequency of waste receipts, it may be advisable for a TSDF to maintain an electronic system for keeping track of generators, wastes, and analytical data. This system can address both the facility's business needs and regulatory obligations for record retention. Systems commonly used by TSDFs include a database of customers and shipping partners, basic account information, and information on their wastes (e.g., profile data). Such information can assist the facility in arranging for shipments and tracking shipments (e.g., using bar codes, manifest tracking numbers, etc.) to and from the facility. The databases maintain

information on a range of parameters of relevant to the waste analysis process (e.g., quantity/types of hazardous wastes of each generator). It may also be helpful to have systems track each shipment of waste received from receipt at the facility through its ultimate disposition or re-shipment off-site. Examples of information include:

- Basics of shipments received (e.g., time/date, quantity, waste type, customer);
- Any significant manifest or other discrepancies and other problems noted at receipt (e.g., a rejection);
- Management method used on-site for each waste (e.g., stabilization, etc.);
- Other waste-specific information related to its disposition (e.g., was it sent off-site for further treatment);
- Summary-level results of waste analyses performed on-site (e.g., frequency at which waste treated at your site passed and failed tests during the year and the steps taken to address failed tests);
- Information on other problems and issues that occur before or after waste acceptance (e.g., summary-level data on the frequency of discrepancies between incoming shipments and their waste profiles and how they were resolved).

Features of an Effective Recordkeeping System

A facility's records are one of the most important tools for regulatory inspectors to evaluate compliance and for facilities to demonstrate compliance.

A facility's recordkeeping system (including electronic system) may need to be designed to provide inspectors with the desired, timely, and accurate/complete information. Important system features include:

- Ability to produce summary-level reports on compliance and implementation problems encountered during the period (e.g., frequency of and reason for occurrence), including statistical analyses
- Ease in tracking compliance and implementation problems to their cause (e.g., a specific waste shipment or an inadequate stabilization recipe) and tracking samples through acceptance
- Ability to demonstrate that the facility resolved problems that were encountered during the period
- Ability to demonstrate that the facility performed its analyses consistently and in accordance with the WAP (e.g., use of internal checklists and audits)

In addition, the regulations give very wide latitude for maintaining information in your operating record. In 40 CFR §264.73, for example, the regulations state that a facility operating record should include "records and results of waste analyses and waste determinations performed as specified in 40 CFR §§264.13, 264.17, 264.314, 264.341, 264.1034, 264.1063, 264.1083, 268.4(a), and 268.7." Because it is broadly written, there are few if any constraints in the type or amount of information that you may be asked to retain under this requirement.

In this regard, you may want to retain records of all analyses required under your WAP. This includes, for example, analyses during pre-acceptance, acceptance (e.g., inspections and fingerprint analyses), and analyses of on-site management (e.g., residuals from on-site treatment or storage). You may need to retain records of analyses that both your facility personnel and, if applicable, on-site laboratory perform.

Similarly, if you are a generator, you should determine the best system for developing and keeping records of your test results and other determinations. Generators are required to keep records of their hazardous waste determinations as required by §262.40(c) and their LDR determinations as required by §268.7(a)(6). The text box below gives some suggestions on information that generators should retain on their hazardous waste and LDR determinations.

Some Suggested Recordkeeping for Generator Hazardous Waste Determinations (§262.11) and LDR Determinations (§268.7(a)(1))*

- List or inventory of all waste streams generated at the site that were subjected to testing or acceptable knowledge under §262.11 and § 268.7
 - Helps the generator and regulators determine if all solid wastes onsite are being properly evaluated and managed under RCRA
 - Should be kept up to date
- Information to be retained for testing determinations under §262.11 and § 268.7
 - Sampling method (e.g., grab vs. composite; number of samples, etc.), rationale for the number of samples collected (e.g., statistical basis), date of samples
 - Parameters analyzed
 - Test methods used, SOPs, credentials of lab that performed the test, date of test
 - Test results, data validation/interpretations, determination
 - Quality control data (e.g., sampling QC data)
- Information to be retained for acceptable knowledge determinations under §262.11 and § 268.7
 - Explanation of determination (e.g., explanation of extrapolations or calculations using SDS, date of determination, etc.)
 - Background information used in the determination (e.g., industry documents, process information, SDS)

* Generators are required to keep records of their hazardous waste determinations as required by §262.40(c) and LDR determinations as required by §268.7(a)(6) and (8). Records must be kept for at least 3 years, as specified.

Finally, generators and TSDFs may want to consult their regulatory agency to learn more about the records that they should retain and/or submit. For example, as a TSDF, you may need to submit records of off-site laboratories that are used (e.g., Quality Assurance Plans, analytical results, etc.). As part of the permitting process, the agency may request that you retain (and include in your permit application) many of the standard operating procedures (SOPs) that you use to perform your waste determinations and analyses.

2.13 Corrective and Preventative Action Measures

It may be helpful for your facility to establish a waste analysis corrective and preventative action program, which could be included in the WAP. Corrective and preventative action, in this context, is defined as the steps that a facility will take to eliminate the cause(s) of a nonconformity or undesirable situation due to a deficiency in current practices. This may include deviations from using proper sampling techniques or out of control quality control data that may affect overall data quality. The purpose of corrective and preventative action is to prevent the recurrence of the nonconformity or undesirable situation by eliminating the cause. Some elements that you may want to include in your corrective and preventative action program include:

40 CFR 264/265.13 do not require WAPs to include corrective and preventative action measures. However, this guidance recommends that such measures be established and described in the WAP to help prevent undesirable situations due to a deficiency in current practices.

- How will deficiencies be identified and reported
- How will a remedy to the deficiency be determined
- What are the timeframes/deadlines for determining the remedy, instituting the remedy, and verifying that the remedy has been properly implemented
- Who is involved in each of the above steps and who is responsible for each item
- If you use subcontractors (e.g., labs), do they have their own corrective and preventative action program and is it sufficient to meet the needs of your facility.

FIGURE 2-9: Example Waste Profile Sheet

Waste Profile #: _____ EPA Facility ID #: _____

I. GENERATOR INFORMATION

1. Generator Name: _____
2. EPA ID #: _____
3. Mailing Address: _____
4. Plant Address: _____
5. Business Contact: _____ Phone #: _____
6. Technical Contact: _____ Phone #: _____

The following information is requested pursuant to 40 CFR 264/265.13 General Waste Analysis (RCRA).

II. GENERAL WASTE INFORMATION

7. Waste Material Name: _____
8. Generator Code (Optional): _____
9. Describe process that generates waste: _____
10. NAICS Code: _____
11. Is your company the original generator of the waste? No Yes If not, provide the name of the original generator: _____
12. If this waste is a still bottom, are you the original generator of the feed stock? No Yes
13. Rate of Generation: _____ Current Accumulation: Drums: _____ Bulk (gal.): _____
14. Check all types of containerization for which you request quotation:

<input type="checkbox"/> 55-gallon steel drum	<input type="checkbox"/> 55-gallon fiber drums
<input type="checkbox"/> 30-gallon steel drum	<input type="checkbox"/> 5-gallon pail
<input type="checkbox"/> 85-gallon steel drum (w/o inside container)	<input type="checkbox"/> bulk (waste viscosity must be < 5000 cps)
<input type="checkbox"/> 85-gallon salvage drum (w/drums inside)	<input type="checkbox"/> other: _____
<input type="checkbox"/> Palletized small containers	

Overall dimensions of material on pallet: X _____ (l X w X h)
 Dimensions of pallet only: X _____ (l X w X h)
 What are the small containers on the pallet? _____ (1 qt. bottles, 8 oz. aerosol cans, etc.)

III. WASTE STREAM CHEMICAL COMPOSITION**

15.

Components Including 40 CFR 261 Appendix VII Hazardous Constituents	Concentration Range (units)	Average % (must total 100%)	TLV (if published)	
			ACGIH	OSHA
	to			
	to			
	to			
	to			
	to			

* If applicable, this Waste Profile Sheet is a new revision of a previously submitted Waste Profile Sheet dated: _____.
 Attach to the Form any additional information which must be known to treat, store, or dispose of the waste in accordance with RCRA §§264/265.13, including but not limited to data developed under RCRA Part 261, Laboratory Analysis Technical Publications or Materials Safety Data Sheets.

**40 CFR 261 Appendix VIII constituents should be identified for combustion facilities, even if not present in high enough concentrations to significantly contribute to the 100% composition.

IV. SPECIFIC ANALYSIS OF WASTE

16. Method used to obtain a **representative sample** of the analyzed waste (i.e., grab, composite, etc.). Sampling methods are described in RCRA 40 CFR 261 Appendix I: _____

Generator's Knowledge & SDS – in completing the next two items, do not leave blanks. If the specific element is not present, indicate "None."

Organic Bound	Concentration Range	Average
Sulfur	to	
Chlorine	to	
Fluorine	to	
Bromine	to	
Iodine	to	
Nitrogen	to	
Phosphorus	to	

17.

Metals (Actual Content) - Base % WT on	
Arsenic (ppm)	Mercury (ppm)
Barium (ppm)	Nickel (ppm)
Cadmium (ppm)	Selenium (ppm)
Chromium (ppm)	Silver (ppm)
Lead (ppm)	Thallium (ppm)
Aluminum (%)	Silicon (%)
Magnesium (%)	Sodium (%)

18. Does this waste contain PCBs \geq 50 ppm? No ___ Yes ___
 If yes, give the concentration regardless of amount and attach supporting documentation: _____
19. Does this waste contain insecticides, pesticides, herbicides, or rodenticides? No ___ Yes ___
 If yes, identify each and the concentrations (ppm): _____
 (Include the SDS for each)
20. Does this waste contain dioxin? No ___ Yes ___
21. Does this waste contain free cyanide > 250 ppm? No ___ Yes ___
22. Does this waste contain free sulfide > 250 ppm? No ___ Yes ___

V. TOXICITY

23.

Check Applicable Data	Explain
Eye	
Inhalation	
Dermal	
Ingestion	
Other	
Carcinogen (suspected or known)	

VI. PHYSICAL PROPERTIES

24. Physical state/viscosity at 70° F: liquid___ semisolid___ solid___ slurry___ sludge___ gas___
 Viscosity (cps): _____

25. Is material pumpable? No ___ Yes ___ If varies, explain _____

26. Is waste multilayered? No ___ Yes ___ If yes, please describe and quantify each layer below:

Top (%): _____

Next (%): _____

Next (%): _____

27. Dissolved Solids (%WT)		32. Vapor Pressure at 70°F	
28. Suspended Solids (%WT)		33. Specific Gravity	
29. BTU Value/lbs		34. pH	
30. Ash Content (% WT)		35. Corrosivity	
31. Flashpoint (°F)		36. Color	

37. What is the Reactivity Group Number(s) for this waste? _____
 (in accordance with *Design and Development of Hazardous Waste Reactivity Testing Protocol*, EPA-600/2-84-057,1984)
38. Is this material stable? No ___ Yes ___ If no, explain: _____
39. Is this material shock sensitive? No ___ Yes ___ If yes, explain: _____

VII. EPA INFORMATION

40. Is this waste hazardous as defined by RCRA 40 CFR Part 261? No ___ Yes ___ If yes, list the applicable EPA Hazardous Waste Number(s) and explain why you have assigned the number(s). For example, if you assign D001, the reason for selection is that the flash point is less than 140° F. If you assign F002, the reason for selection may be that the waste is the still bottom from the recovery of methylene chloride.

EPA Hazardous Waste Numbers	Reason for Selection

41. If the answer to #40 is yes, list CERCLA reportable quantities found in 40 CFR Part 302.4: _____
42. If the waste is not hazardous as defined by federal regulations but is hazardous as defined by state regulations in which the waste was generated, please provide the state hazardous waste number(s). Also, provide any state hazardous number(s) that are not included in the federal regulations:

State Hazardous Waste Numbers	Reason for Selection

VIII. SAMPLING INFORMATION

43. Sample source (e.g., drum, lagoon, pond, tank, vat, etc.): _____
 Date Sampled: _____ Sampler's Name/Company: _____
44. Generator's Agent Supervising Sampling: _____
 If no sample required, provide rationale: _____

IX. LAND DISPOSAL RESTRICTIONS INFORMATION

45. Identify all characteristic and listed EPA hazardous waste numbers that apply (as defined by 40 CFR Part 261). For each waste number, identify the subcategory (as applicable, check none, or write in the description from 40 CFR 268.40).

EPA Hazardous Waste Code(s)	Subcategory (enter subcategory or none if not applicable)		Applicable Treatment Standards			Management Restrictions (Designate A-D per below)
			Performance Based (check as applicable)		Specified Technology (enter 268.42 Table 1 codes)	
	Description	None	268.41(a)	268.43(a)	268.42	

To list additional EPA waste numbers and categories, use additional page and check here: _____

If this waste includes any RCRA Codes D001 through D043, can this waste reasonably be expected to exceed the 40 CFR 268.48 Universal Treatment Standards (UTS) for any Underlying Hazardous Constituent(s)? No ___ Yes ___
 If yes, include an attachment that identifies each constituent expected to exceed the UTS.

Management under the land disposal restrictions:

- A. Restricted waste requires treatment? No ___ Yes ___
- B1. Restricted waste treated to performance standards? No ___ Yes ___ Method: _____
- B2. Restricted wastes for which the treatment standard is expressed as a specified technology (and the waste has been treated by that technology)? No ___ Yes ___ Method: _____
- B3. Good faith analytical certification for incinerated organics No ___ Yes ___
Method: _____
- C. Restricted waste subject to a variance? No ___ Yes ___
Date/Type: _____
- D. Restricted waste can be and disposed without further treatment? No ___ Yes ___

X. DOT INFORMATION

In accordance with the Department of Transportation 49 CFR Parts 171 through 177, complete the following:

- 46. DOT Proper Shipping Name: _____
- 47. DOT Hazard Class: _____
- 48. DOT UN or NA Number: _____
- 49. Container Label(s) - for containers of 110 gallons or less: _____
- 50. Placards: _____
(Generator's hazardous waste shipments must also comply with the labeling requirements of RCRA 40 CFR Part 262)
- 51. Is this waste a soil and/or debris? No ___ Yes, Soil: ___ Yes, Debris: ___ Yes, Both: ___

52. Complete Only for Wastes Intended for Fuels or Incineration (Total)	53. Reclamation, Fuels or Incineration Parameters (provide if information is available)
Antimony as Sb (ppm)	A. Heat value range (BTU/lb.): _____ to _____
Beryllium as Be (ppm)	B. Water: _____
Potassium as K (ppm)	C. Viscosity (cps): _____ @ ° F 100° F 150° F
Sodium as Na (ppm)	D. Ash (%): _____
Bromine as Br (ppm)	E. Settleable Solids (%): _____
Chlorine as Cl (*ppm or %)	F. Vapor Pressure @ STP (mm/Hg): _____
Fluorine as F (*ppm or %)	G. Is this waste a pumpable liquid? <input type="checkbox"/> No <input type="checkbox"/> Yes
Sulfur as S (*ppm or %)	H. Can this waste be heated to improve flow? <input type="checkbox"/> No <input type="checkbox"/> Yes
*indicate ppm or %	I. Is this waste soluble in water? <input type="checkbox"/> No <input type="checkbox"/> Yes
	J. Particle Size: Will the solid portion of this waste pass through a 1/8-inch screen? <input type="checkbox"/> No <input type="checkbox"/> Yes

- 54. Special Handling Information: _____

XI. ACCOUNTABILITY STATEMENT

55. I hereby certify that all information in this and all attached documents contains true and accurate descriptions of this waste. Any sample submitted is representative as defined in 40 CFR 262 Appendix I or by using an equivalent method. All relevant information regarding known or suspected hazards in the possession of the generator has been disclosed. I authorize (_____) to obtain a sample from any waste shipment for purposes of recertification.

Authorized Signature

Date

Printed (or typed) Name and Title

PART THREE: Checklist*

	Yes	No	Comments
1. Facility Description			
a. Are all processes that generate hazardous waste identified?			
b. Is sufficient information provided for each process to confirm that all hazardous wastes are identified?			
c. Have all hazardous waste management units been identified?			
d. Are descriptions of all hazardous waste management units provided?			
e. Have all hazardous and solid wastes been identified for each unit?			
f. Have the methods of waste management (e.g., stabilization) been described for each unit?			
g. Are process design limitations defined for each hazardous waste management unit?			
h. Have operational acceptance limits been established for each hazardous waste management unit?			
i. Are procedures in place to determine whether wastes are outside of their respective acceptance ranges?			
j. Do operational acceptance limits include applicable regulatory restrictions?			
2. Systematic Planning			
a. Does the WAP incorporate a process for systematic planning, such as the Data Quality Objectives (DQO) process?			
b. Do personnel training records (located in the permit application) demonstrate that facility personnel supervising and conducting waste sampling and analysis have received appropriate training in systematic planning?			
3. Selecting Waste Parameters			
a. Are parameters for waste analysis identified (and, if applicable, included in the WAP)?			
b. Does the WAP identify a rationale for the selection of each waste analysis parameter?			
c. Does the WAP include parameters for the special waste analysis requirements 40 CFR §§264/265.17, 264/265.314, 264/265.341, 264/265.1034 (d), and 266.102(b), if applicable?			

	Yes	No	Comments
d. Have operational acceptance limits been defined as they related to waste properties and process?			
e. Do operational acceptance limits include regulatory restrictions?			
f. Do waste analysis parameters address applicable operational acceptance limits?			
4. Selecting Sampling Procedures			
a. Has the number of sampling locations been identified?			
b. Are sampling procedures for each waste type identified?			
c. Are descriptions and justifications provided for any modified or non-standard procedures approved by EPA?			
d. Have decontamination procedures for sampling equipment been developed?			
e. Have sampling strategy techniques (e.g., grab, composite) been specified?			
f. Are procedures for sampling multi-phase wastes addressed, if applicable?			
g. Has all sampling equipment been identified?			
h. Have the number and types of sampling containers been specified?			
i. Have sample preservation techniques been specified?			
j. Are sampling quality assurance and quality control procedures been documented?			
k. Are proper packing and shipping procedures documented?			
l. Have procedures for the maintenance of all sampling equipment been documented?			
m. Are the precision and accuracy of all sampling equipment been documented?			
n. Are health and safety procedures for the protection of sampling personnel specified?			
5. Selecting a Laboratory and Laboratory Analytical Methods			
a. Are laboratory analytical methods specified for each waste managed at the facility? If, not, is other information (i.e., acceptable knowledge) used to demonstrate waste analysis?			
b. Has a rationale been specified for each analytical method?			
c. Do the selected analytical methods meet all regulatory requirements for the identification of each hazardous waste (e.g., each hazardous waste characteristic)?			

	Yes	No	Comments
d. Are descriptions and justifications provided for any modified or non-standard methods, as approved by EPA?			
e. Have chain-of-custody procedures for samples been specified, if necessary?			
f. Does the laboratory have an adequate QA/QC program?			
g. Have QA/QC procedures for each analytical procedure been identified?			
6. Quantifying Data Uncertainty			
a. Does the WAP incorporate a process for quantifying data uncertainty so that laboratory results are capable of supporting the facility's waste management decisions (i.e., is there an appropriate level of certainty in the results)?			
7. Selecting Waste Re-Evaluation Frequencies			
a. Have site-specific criteria for waste re-evaluations been specified?			
b. Is re-evaluation accomplished with adequate frequency?			
c. Are mechanisms in place for re-evaluating the sampling program each time the waste generating processes change?			
d. Do the re-evaluation procedures specify criteria for the acceptance of wastes received from off-site generators?			
e. Do you notify off-site facilities (i.e., TSDFs) of changes in waste characterizations due to process changes and other factors?			
8. Special Procedural Requirements, Where Applicable			
a. Are procedures in place to verify the sources of the information provided from off-site generators or TSDFs?			
b. Have criteria been established for the pre-acceptance procedures of wastes based on information from off-site generators or TSDFs?			
c. Are procedures for waste inspections in place?			
d. Have fingerprint analysis parameters been developed?			
e. Have criteria been established for the acceptance of wastes based on the results of fingerprint analysis?			
f. Is there a methodology for identifying ignitable, incompatible, or reactive wastes?			
g. Are procedures in place to conduct testing to determine whether wastes are incompatible with each hazardous waste management unit on-site?			
h. Have all wastes restricted under the LDRs been identified?			

	Yes	No	Comments
i. Are procedures in place to ensure that wastes met applicable LDR treatment standards prior to land disposal?			
9. Discrepancy Policy			
a. Are procedures in place to resolve discrepancies between incoming shipment and its manifest?			
b. Are the procedures in compliance with applicable manifest discrepancy regulations (Part 264/265, Subpart E)?			
c. Are procedures in place to resolve discrepancies between incoming shipment and its waste profile?			
d. Do these procedures include a process for re-characterizing the waste and revising or preparing a new profile when needed?			
10. Rejection Policy			
a. Are procedures in place to reject a waste in accordance with applicable RCRA regulations (Part 264/264, Subpart E)?			
b. Are these procedures coordinated with the discrepancy policy as necessary?			
11. Recordkeeping			
a. Does the WAP clearly identify all of the types of records that will be kept?			
b. Does the WAP indicate the length of time that records will be kept and are these timeframes in compliance with applicable regulations?			
c. Will the facility produce summary-level reports based on its records, to describe its compliance with applicable WAP requirements (e.g., on LDR compliance testing)?			
d. Will the facility's recordkeeping systems produce records to on-site inspectors in a timely and organized fashion?			
12. Corrective and Preventative Action			
a. Is a corrective and preventative action program in place to identify and eliminate the cause(s) of nonconformities and undesirable situations due to deficiencies in current laboratory practice?			
b. Does the WAP describe how deficiencies will be reported and remedies determined?			
c. Does the WAP spell out the timeframes for reporting and resolving problems?			
d. Are responsible personnel identified (e.g., by position)?			

* Refer to Part Two of this manual for additional information on these checklist items. Note that some items are mandatory and others are recommended.

PART FOUR: Sample WAPs

This chapter presents two WAPs that EPA has compiled from different types of TSDFs. The examples are intended to give permit applicants and permit writers ideas and issues to consider when preparing or approving a WAP. However, as discussed below, the examples are not complete or approvable as presented and should be used only as a learning tool. An occasional call-out box is included in the WAPs to highlight certain issues. **As a permit applicant, you should not simply “copy and paste” text from the examples into your WAP. Rather you should carefully understand how to develop your WAP in accordance with the regulations and ensure that it is appropriate for your own facility. Furthermore, it is important that you carry out and implement the necessary procedures, as outlined in your WAP, to satisfy the regulatory WAP requirements.** Every WAP is different and should account for facility- and state-specific considerations and comply with all applicable requirements.

The following WAPs are presented:

- **Example 1** belongs to ACE Chemical Services, which is a commercial treatment and disposal facility. It receives hazardous waste shipments from offsite, performs stabilization and other forms of treatment, and landfills the treated waste onsite.
- **Example 2** belongs to Container Management Incorporated (CMI), which is a commercial storage facility. It receives shipments from offsite customers, performs minimal waste handling (e.g., consolidation), and ships the waste offsite for further management and disposal.

Although the federal regulations are cited in the examples, you should consult and reference your own state’s regulations when preparing your WAP. States may require more and/or different information.

Please note that the example WAPs have been edited as follows:

- The name of the actual TSDF and other identifying information have been removed or changed; and
- The WAPs have been edited to reduce their overall length and modify content. For example, some of their text, graphics and/or attachments may have been shortened, simplified or removed. This was done solely to facilitate their presentation in this guidance. Notations have been inserted to indicate when text has been shortened from its original version. Any WAP submitted by a permit applicant must include **all** required and appropriate text, graphics, and attachments.

Example WAP 1: Waste Analysis Plan for ACE Chemical Services

DRAFT

Table of Contents

A. Waste Analysis Plan	4-5
A-1 Introduction	4-5
A-2 Pre-acceptance Procedure	4-6
A-2.1 Generator-Supplied Information	4-6
A-2.2 Initial Review and Analysis	4-7
A-2.3 Disposal Decision Process	4-8
A-2.4 Re-Evaluation Process	4-8
A-3 Acceptable Waste Codes	4-9
A-4 Analyses during Waste Acceptance and Process Operations	4-9
A-4.1 Verification of Incoming Shipments	4-12
A-4.1.1 Visual Inspection	4-12
A-4.1.2 Chemical Screening	4-12
A-4.1.3 Discrepancy Resolution	4-15
A-4.1.4 Supplemental Verification	4-15
A-4.1.5 Final Acceptance	4-15
A-4.2 Process Operations Procedures	4-16
A-4.2.1 Storage	4-16
A-4.2.2 Stabilization	4-17
A-4.2.3 Landfill Disposal	4-18
A-5 Restricted Wastes	4-20
A-6 Rejection Policy	4-20
A-6.1 Authority	4-21
A-6.2 Safety	4-21
A-6.3 Scheduling	4-21
A-6.4 Documentation	4-21
A-6.5 Notification	4-21
A-6.6 Rejection	4-22
A-7 Discrepancy Resolution	4-22
A-7.1 Manifest Discrepancy	4-22
A-7.2 Discrepancies Between Waste Received at Facility and Waste Profile	4-22
A-8 Sampling Methodology	4-23
A-8.1 General Methods and Equipment	4-24
A-8.2 Specific Methods and Equipment	4-24
A-8.2.1 Containers and Tanks	4-25
A-8.2.2 LDR "Grab" Sampling	4-25
A-9 Parameters and Analytical Methods	4-26

A-10 Quality Assurance /Quality Control	4-28
A-10.1 Introduction	4-28
A-10.2 Sampling Program	4-28
A-11 Data Reporting	4-29
A-12 Recordkeeping	4-29
A-13 Corrective Action	4-31
Appendices	4-32
Appendix A-1 Waste Profile Sheet	4-32
Appendix A-2 Overview of the Pre-Acceptance Process	4-32
Appendix A-3 Overview of the Incoming Load Process	4-32
Appendix A-4 Aqueous Waste Treatment	4-32
Appendix A-5 Landfill and Stabilization	4-32

DRAFT

US EPA ARCHIVE DOCUMENT

A. Waste Analysis Plan

In accordance with the regulatory requirements set forth in 40 CFR 264.13, ACE Chemical Services, L.L.C. (ACE) has developed this Waste Analysis Plan as an integral part of the permit application for its treatment, storage and disposal facility. The procedures set forth in this plan dictate that this facility will be in compliance with all requirements of 40 CFR 264.13. A copy of this plan will be available at the facility at all times.

A-1 Introduction

The purpose of this Waste Analysis Plan (WAP) is to identify and document the necessary sampling methodologies, analytical techniques and overall procedures which are undertaken for all wastes that enter this facility for storage, treatment or disposal. Specifically the plan delineates the following:

- Pre-Acceptance Procedures – Section A-2 outlines the procedural steps ACE will take to evaluate the acceptability of a candidate waste stream pursuant to permit conditions and operating capabilities prior to shipment and acceptance of the waste for management at the site, including re-evaluation frequency.
- Acceptable Waste Codes – Section A-3 summarizes the wastes that ACE facility is approved to accept.
- Waste Analyses Performed by ACE Facility – Section A-4 describes the analyses performed on incoming shipments and wastes in process operations.
- Restricted Wastes – Section A-5 summarizes wastes that ACE facility is not approved to accept.
- Rejection Policy – Section A-6 discussed the policy and procedures that ACE will use for the acceptance or rejection of waste received by the facility.
- Discrepancy Policy – Section A-7 discusses ACE facility's procedures for resolving manifest discrepancies and discrepancies between incoming waste shipments and their waste profile.
- Sampling Methodology – Section A-8 outlines the proper sampling method(s) for a given waste type (solid, sludge, liquid) and containment (drum, tank, impoundment pile, etc.). ACE personnel can then obtain waste identification samples to help ensure accurate analytical results when a waste is analyzed.
- Analytical Parameters, Techniques and Rationale – Section A-9 outlines the parameters, rationale and methods ACE will utilize to determine or identify certain waste properties to ensure proper management of the waste at the site.
- Quality Control Policy – Section A-10 outlines the quality control policy this site will follow to achieve high quality analytical results.

- **Data Reporting** – Section A-11 identifies the data that ACE facility will supply to the state Director under this WAP.
- **Recordkeeping** – Section A-12 identifies the records that ACE facility will retain on site related to waste analyses performed under this WAP.
- **Corrective Action** – Section A-13 describes the procedures that ACE facility will take to resolve issues, needs or problems that may arise in connection with its laboratory operations.

WAP Accountability

Consider identifying those individuals, by title, who are ultimately responsible for ensuring WAP compliance. This will increase accountability.

The Approvals Manager, Laboratory Manager, Technical Manager, General Manager or their designees are individually and collectively herein referred to as “ACE site management”.

A-2 Pre-acceptance Procedure

ACE has developed a series of control procedures to determine the acceptability of specific wastes for management at the site, referred to as the “Pre-acceptance Procedures.” The pre-acceptance procedures include the following steps:

- **Generator-supplied information** is what a customer must provide to enable ACE to make an initial decision regarding the appropriateness/acceptability and possible management of a candidate waste stream.
- **Initial review and/or analysis** of the generator-supplied material allows ACE to conduct an initial evaluation for management capabilities at the facility.
- **Disposal decision** is the process of reviewing all the documentation supplied by the generator and/or ACE and documenting the acceptance or rejection of the candidate waste stream.
- **Re-evaluation** process determines the frequency a waste stream will be re-evaluated once it has been accepted.

A-2.1 Generator-Supplied Information

The waste generator will supply ACE with the following information and materials for each new candidate waste stream, except where noted herein.

- **Waste Profile Sheet**, (WPS), which will contain pertinent chemical and physical data. At a minimum, the generator supplies all the information required by 40 CFR 264.13(a)(1) needed to characterize the waste for proper treatment, storage, or disposal. ACE may assist the generator in completing information provided by the generator based on its evaluation. The complete package is reviewed and approved by the generator at the completion of the approval process.

- A standard profile is a profile that is used for multiple waste streams that are similar in physical and chemical characteristics. Standard profiles will be used only for wastes that share the same:
 - Generating process. The generating process should be described in sufficient specificity. For example, for electroplating, this would include an indication of type of electroplating (zinc electroplating, chromium electroplating, etc.) and a narrative description of the generating process.
 - Raw ingredients used in the generating process. The waste profile should include a complete list of the ingredients used in the process that generates the waste; and
 - Onsite management method. If two wastes require different management methods at the ACE facility (e.g., pre-treatment vs. no pretreatment before stabilization), they require different waste profiles.
- A representative sample is required of all waste streams, with limited exceptions. Refer to Sections A-4 and A-9 of this WAP for parameters to be analyzed during pre-acceptance. No representative sample is required for the following:
 - Labpacks. Lab pack chemicals are managed in accordance with all applicable state regulations based on certifications presented.
 - “Empty” containers of waste materials. Commercial products or chemicals. This applies to a portable container which has been emptied but which may hold residues of the product or chemical (e.g., portable tanks, drums, barrels, cans, bags, liners, etc.). A container shall be determined RCRA “empty” according to the criteria specified in 40 CFR Part 261.7.
- Land Disposal Restriction Notification/Certification Information and/or Data (40 CFR Part 268).
- Other supporting documentation such as additional analytical results or a safety data sheet (SDS), as necessary to provide additional waste characterization.

Sampling During Pre-Acceptance

Analysis of a sample may be necessary during pre-acceptance (e.g., if the receiving facility has compliance requirements for treatment or disposal, such as LDR numerical limits).

A-2.2 Initial Review and Analysis

Once ACE receives the generator-supplied information and it is reviewed, a determination will be made if further analyses by the generator or ACE are required. All waste samples will be subjected to the analyses identified in Section A-4, as appropriate. Additional testing may also be requested by the site management if needed.

If, during the pre-acceptance procedure, ACE determines that the waste information indicated by the testing does not completely conform to the information on the WPS, the generator is notified of the apparent inconsistency. If the inconsistency is resolved, the pre-acceptance procedure continues. The waste may be rejected or accepted during this phase of the procedure.

A-2.3 Disposal Decision Process

The pre-acceptance procedure is concluded when the review of the generator supplied information and any appropriate mandatory analyses is complete. At this time, ACE makes a “disposal decision” on the candidate waste. Disposal decisions are based on:

- Management methods available.
- Conditions or limitations of existing permits and regulations.
- Capability to safely manage the waste.
- WPS description of the process generating the waste.
- Knowledge of the waste generating process.
- WPS description of the chemical and physical properties of the waste.
- Any additional documentation supplied by the generator (e.g., LDR certifications).
- Results of any verification analyses.
- Results of any analyses of process operations procedures.
- Management’s technical experience and judgment.

A-2.4 Re-Evaluation Process

In accordance with 40 CFR 264.13(a)(3), a waste profile re-evaluation will be conducted when one of the following occurs:

- A generator notifies ACE that the process generating the waste has changed;
- The results of inspection or analysis indicate that the waste received at the facility does not match the identity of the waste designated on the accompanying manifest (or shipping paper) or pre- acceptance documentation (See Discrepancy Policy in Section A-7); or
- At the end of each calendar year for all wastes received and managed during the year, as follows:
 - ACE will conduct a comprehensive annual review of all wastes accepted onsite by comparing the results of fingerprint analyses (which are maintained in ACE’s in-house waste tracking system) to the WPSs to identify any pattern of discrepancy (e.g., pH of fingerprinted waste that falls outside its tolerance limits (as described herein) more than 20% of the time).

WAP Performance Evaluation

Consider including provisions in the WAP for the facility to evaluate their WAP performance continually and keep records. This will promote on-going improvements and assist regulators during compliance inspections.

- ACE will conduct an annual evaluation of its post-treatment results to identify instances where the treatment standards were not met and treatment had to be repeated. In these cases, ACE will evaluate the incoming waste to determine if their WPSs are accurate or if they should be re-characterized and WPSs revised to provide better information to enable more effective treatment.
- ACE will send all WPSs to the generators annually for their review, revisions if needed, and re-certification. Generators will be asked to re-evaluate each WPS to determine if the generation process (e.g., raw ingredients, generating process) or waste (e.g., waste codes) has changed such that a new or revised WPS is needed.

A-3 Acceptable Waste Codes

In brief, this facility accepts waste codes D001 through D043, F001 through F039 (except F020 through F028), K001 through K172, P001 through P205, U001 through U411 (except as otherwise noted in Section A-5 of this WAP regarding restricted waste). Refer to the latest version of this facility's RCRA permit (dated December 2011) for a complete list of the RCRA waste codes that this facility is approved to accept and manage onsite. The list in the permit supercedes the language in this WAP.

A-4 Analyses during Waste Acceptance and Process Operations

As discussed in Section A-2, ACE site management samples each waste that undergoes the pre-acceptance procedures, with limited exceptions. When a shipment of hazardous or non-hazardous waste is received at the ACE facility, verification of the shipment is performed. Verification activities include container receipt inspection. It also includes chemical screening according to the frequencies specified in this section. Any discrepancies between the verification results and waste profile must be resolved in accordance with the Discrepancy Policy discussed in Section A-7 before the shipment can be accepted at the facility. In addition, process operations procedures are performed to ensure that the waste is managed safely and in accordance with applicable regulations.

Summary of All Analyses Performed

It is recommended that a summary of all sampling/analysis performed at the facility (e.g., parameters and testing frequency) be presented in one place in the WAP. Tables and graphics are helpful. See Tables A-1 and A-2 for example. Subsequent sections of the WAP can go into greater detail.

Note that this WAP does not summarize testing of wastes **generated** by ACE; however, there should be some discussion of this.

Table A-1 summarizes the parameters that are examined for each of these screening analyses. Parameters for waste analysis during pre-acceptance are shown in Column 2. Once the waste is approved during pre-acceptance, all incoming shipments are subjected to mandatory verification, including inspections and chemical screening (Column 3A). In addition, supplemental analyses may be performed to resolve discrepancies between the verification results and waste profile (Column 3B). Finally, analyses are performed as

necessary for process operations that are conducted onsite (Columns 4A-C). Specifically, for incoming wastes that will be placed into storage, ACE performs the mandatory verification in Column 3A to determine appropriate storage procedures, such as segregation of incompatible waste (Column 4A). For incoming wastes to be stabilized, ACE performs the mandatory verification in Column 3A to determine appropriate treatment (Column 4B). Finally, ACE performs “Suitability for Landfill” analyses (e.g., TCLP to ensure compliance with 40 CFR part 268 treatment standards) for any waste to be landfilled at the ACE facility (Column 4C). This includes (1) incoming wastes for which the generator or treater has certified compliance with all applicable treatment standards and (2) wastes stabilized onsite by the ACE facility. **Note that ACE’s onsite treatment is designed to address only the inorganic constituents of the waste; it does not treat organics.** Table A-2 summarizes the frequency by which each of these analyses must occur. Refer to ACE’s SOPs for additional information on sampling frequency.

TABLE A-1: Analyses Performed by ACE Facility ^a

1. Indicator Parameters	2. Pre-Acceptance	3. Incoming Shipments		4. Process Operations Procedures		
		A. Mandatory Verification	B. Supplemental	A. Storage of Incoming Shipments	B. Stabilization of Incoming Shipments	C. Landfill ^b
Physical Description	X	X	X	NA ^c	NA ^d	O
pH Screening	X	X	X			O
PCB Screening	X	X	X			O
Suitability for Landfill	X		X			X
Water Mix Screening	X	X	X			O
Flammability Potential Screening	X	X	X			O
Sulfide Screening	X	X	X			O
Radioactivity Screening	X	X	X			O
Ash Screening	X	O	X			O
Compressive Strength	X	O	X			O
Conductivity	X	O	X			O

a. X = parameters that are examined for each waste.

O = parameters that are examined as necessary. NA = not applicable.

b. This column applies to the following that are destined for the ACE landfill: (1) stabilized wastes received from offsite that have been certified by the generator or treater as meeting all applicable LDR treatment standards and (2) wastes that have been stabilized onsite by ACE facility. The table shows that such wastes are subject to the “Suitability for Landfill” analyses (e.g., TCLP) before disposal. Other analyses may also be performed at site management’s discretion. ACE facility also implements an Additional Review Program described in Section A-4.2.3.

c. Incoming wastes to be placed in storage will be subject to mandatory verification in Column 3A.

d. Incoming wastes to be stabilized before onsite disposal will be subject to mandatory verification in Column 3A.

NOTE: Table A-1 has been shortened in order to reduce the overall length of this example WAP. This was done **solely** for purposes of presentation in this guidance document.

TABLE A-2: Summary of Frequency of Analysis

Pre-Acceptance	Verification of Incoming Shipments		Process Operations Procedures		
	Mandatory Verification	Supplemental	Storage of Incoming Shipments	Stabilization of Incoming Shipments	Landfill ^a
On each waste undergoing pre-acceptance, except as otherwise specified	<p>On each incoming shipment as follows:</p> <ul style="list-style-type: none"> Visual inspection of each shipment, including inspection of opened containers to confirm physical description Chemical screening of each bulk load Chemical screening of each container shipment as determined by ACE site management. See Section A.4.1.2 of this WAP for additional information. 	Whenever a discrepancy between waste and WPS is found that cannot be resolved by generator and ACE	For incoming wastes to be placed in storage, see the frequency for Mandatory Verification	For incoming waste to be stabilized, see the frequency for Mandatory Verification	<p>For stabilized waste that is shipped to ACE for which the generator or treater has certified full LDR compliance: each shipment will be analyzed for Landfill Suitability. This frequency can be decreased, as follows, if 10 successive shipments meet all applicable LDR standards:</p> <ul style="list-style-type: none"> 1 in 10 shipments is analyzed for all required parameters; and Every shipment is analyzed for an indicator parameter (e.g., pH) to confirm treatment effectiveness^b <p>For waste that has been stabilized by ACE onsite: each batch will be analyzed for Landfill Suitability</p> <p>ACE will also visually inspect each waste before placement in the landfill to ensure that no free liquids are present. A paint filter test (or comparable test) will be performed if there is any question, the liquids will be removed, the test will be repeated.</p>

^a This column applies to (1) wastes received from offsite that have been certified by the generator or treater as meeting all applicable LDR treatment standards and are destined for the ACE landfill and (2) wastes that have been stabilized onsite by ACE facility and are destined for the ACE landfill.

^b If any shipment fails to meet the treatment standards, 100% testing must be resumed, as specified in this WAP, until a subsequent set of 10 successive shipments meet all applicable LDR standards.

The following sections provide more information on the analyses that ACE site management will perform.

A-4.1 Verification of Incoming Shipments

Verification of incoming shipments involves inspection of containers and chemical screening. As part of the facility's training program described in the Part B permit, personnel will be taught how to perform the verification procedures effectively and safely.

A-4.1.1 Visual Inspection

The container receipt inspection is a mandatory element of the confirmation process. Therefore, 100 percent of the incoming shipments are inspected and physically verified for damage and to ensure the waste containers are those indicated on the documentation. This activity is a mechanism for identifying any document discrepancies or damaged containers before acceptance. The container receipt inspection is performed by ACE management, who will ensure that the shipment: (1) is received in good condition and does not include bulging or other irregularities, (2) is the waste indicated on the manifest or shipping papers, and (3) is complete. In addition, at least one container from each profiled waste in a shipment will be opened and its contents will be visually inspected to confirm it matches the physical description on its profile. The visual inspection will address color, viscosity, and waste form (e.g., debris, PPE, sludge), at a minimum.

Visual Inspection of Containers

This WAP requires visual inspection of 100% of shipments received, including opening some containers to view their contents. This is important for confirming the physical description of the waste and supplementing the chemical screening, which is performed on only a subset of containers.

A-4.1.2 Chemical Screening

Chemical screening is considered an additional verification element. Selection and interpretation of the appropriate chemical screening method(s) are conducted by personnel who are qualified as described in the permit. The objective of chemical screening is to obtain reasonable assurance that the waste received by the TSD unit is consistent with the description of the waste on the waste profile and to provide information that will be used to safely manage the waste at the TSD unit. After chemical screening is done, tamper-resistant seals are applied over the container opening on each outer container screened.

As shown in Table A-2, each bulk load (i.e., truck) will be screened chemically. Samples from the front, middle and back of each load will be obtained and composited, if possible. However, composite samples across separate loads will not be taken.

Container shipments will be chemically screened according to the Performance Evaluation System (PES) and associated procedures, described below.

Chemical Screening Frequency for Container Shipments. Shipments of containers received by ACE will be chemically screened as follows:

- If each container in a shipment holds a different profiled waste, each container will be chemically screened as follows:
 - Once per year: No concerns identified.
 - Once every 6 months: Concern(s) identified in one criterion.
 - Once every 3 months: Concerns identified in two or more criteria.
- However, if multiple containers in a shipment (i.e., 2 or more) hold the same profiled waste, one or more samples will be collected from them and chemically screened. Based on the identification of concerns during the Performance Evaluation System (described below), ACE site management will establish the initial chemical screening frequency for multiple containers based on the following criteria:
 - If no concerns are identified: Initial chemical screening frequency of, at a minimum, 10 percent.
 - If concerns are identified in one criterion: Initial chemical screening frequency of, at a minimum, 20 percent.
 - If concerns are identified in two or more criteria: Initial chemical screening frequency of 30 percent.
- For example, if ACE receives a shipment of 2 to 10 containers holding the same profiled waste, ACE would sample one of them, assuming no concerns were identified. If ACE receives a shipment of 11 to 20 containers holding the same profiled waste, ACE would sample two of them, assuming no concerns were identified.

Chemical Screening Frequency

This approach to chemical screening may appeal to some facilities because it allows a gradual reduction in frequency for certain shipments. However, the approach raises some issues:

- Is it acceptable to chemically screen certain shipments only once or twice per year? What if the generator's waste changes mid-year and the facility is not notified. How would this change be detected?
- Does the screening approach give too much discretion to the facility to determine initial frequencies and reductions?

Composite samples will not be taken across containers holding different profiled wastes.

Description of Performance Evaluation System (PES). The PES is used to determine the initial chemical screening frequency of each generator's containerized waste streams. This includes determining the number of concerns we have regarding each waste. We organize our concerns under "criterion." We revise the criteria and concerns annually based on operating conditions, regulatory requirements, and other relevant considerations. Examples of criteria include:

- Historical performance of the generator (e.g., has the generator's performance in characterizing its wastes been satisfactory, and if not, what concerns have been identified?);

- Nature of the waste (e.g., is it a novel/unknown waste stream, and if so, what potential concerns are associated with its management at this facility?); and
- Elapsed time since generator's last shipment (e.g., has the generator made a shipment within the past year, and if not, is there a concern, such as potential changes in its waste generating processes that we may be unaware of).

PES provides a periodic status of an individual generator's performance for containerized waste received. Also, PES provides a mechanism for determining corrective actions, resolving waste acceptance issues, and chemical screening frequency adjustments when a problem has been discovered.

In addition, an annual performance evaluation is used to trend a generator's performance and is used to raise the generator's overall group of streams chemical screening frequency based on the type of issue. The evaluation should be objective and should consider the discrepancy issues documented during the pre-acceptance and verification functions. The ACE site management will: (1) perform annual evaluations based on deficiencies and discrepancy issues identified, (2) evaluate unsatisfactory performance for corrective actions, and (3) adjust chemical screening rates accordingly.

Process for Reducing the Chemical Screening Frequency for Multiple Containers Holding Same Profiled Waste. After the initial screening frequency for a given waste profile has been established or increased, the chemical screening frequency can be reduced in accordance with the following process.

The chemical screening frequency will be reduced gradually, as shown in Table A-3. Reduction is based on the ability to demonstrate that five containers from the profiled waste in question pass verification. In addition, reduction to the minimum frequency requires that the ACE site management documents an acceptable evaluation of the corrective action plan, if applicable. At no time will the chemical screening frequency be reduced below 10 percent for waste received from offsite.

Table A-3 shows that, for containers for which no concerns were identified during the PES, a 10 percent screening is established. This frequency cannot be reduced further. For containers for which concerns were identified in one criterion, the initial screening of 20 percent will be reduced to 10 percent after 5 containers pass verification. For containers for which concerns were identified in two or more criteria, the initial screening of 30 percent will be reduced to 20 percent after 5 containers pass verification and to 10 percent after 10 containers pass verification.

TABLE A-3: Reduced Chemical Screening Frequency^a

Concerns Identified	Initial Screening Frequency	Reduced Frequency After 5 Containers Pass Verification	Reduced Frequency After 10 Containers Pass Verification
None	10% ^b	N/A	N/A
Concern(s) identified in one criterion	20%	10% ^b	N/A
Concerns identified in two or more criteria	30%	20%	10% ^b

^a This table applies to multiple containers holding the same profiled waste. N/A = not applicable.

^b 10 percent is the minimum screening frequency allowed.

A-4.1.3 Discrepancy Resolution

Discrepancy issues identified during verification of any shipment (i.e., bulk or container) could result in a waste container that does not meet ACE waste acceptance criteria. If a possible discrepancy issue is identified, the actions described in Section A-7 of this WAP must be taken.

A-4.1.4 Supplemental Verification

If the mandatory verification of incoming shipments identifies a discrepancy with the WPS, and the discrepancy cannot be resolved by the generator, then ACE will perform supplemental analysis of the waste, reject the waste back to the generator, or ship the waste to an alternate treatment, storage, or disposal facility. ACE will notify the state Director of any wastes rejected back to generators. A supplemental analysis includes tests for the parameters shown in Table A-1 in Section A-4.

Any waste that is subject to a supplemental analysis will be quarantined until the discrepancy with the WPS is resolved.

Supplemental analysis will be subcontracted to an independent state certified or NELAC laboratory that uses ASTM and/or SW-846 analytical and test methods. The results of all supplemental analyses will be documented in a log maintained as part of the facility operating record.

A-4.1.5 Final Acceptance

Upon verification that a containerized waste or bulk waste is consistent with the corresponding WPS, the waste will be moved from the receiving area to an appropriate storage cell. Movement to an appropriate storage cell shall occur within the time limitations required by the state's regulations (e.g., 24 hours) after off-loading waste from the transport vehicle.

Any waste that does not conform to the corresponding WPS will be quarantined until the discrepancy is resolved with the generator. Upon resolution of the discrepancy, the waste will be moved to an appropriate storage cell by the end of the work shift.

A-4.2 Process Operations Procedures

NOTE: Some portions of Section A-4.2 have been removed in order to shorten the overall length of this example WAP. This was done solely for purposes of presentation in this guidance document.

Many of the analyses needed for the storage, treatment, and disposal functions are performed during incoming load identification. These are not repeated unless it is known or believed that the waste characteristics may have changed during storage or processing and monitoring of the changes is necessary. Existing and anticipated process operations at the facility, for which current and periodic sampling and analyses is important, include the following:

- Storage;
- Stabilization; and
- Landfill disposal.

The analytical procedures for each of these processes are described separately below.

A-4.2.1 Storage

When waste is received at the ACE facility, a verification analysis is performed to determine its physical and chemical properties (e.g., pH, flammability, etc.). ACE site management will review the results of the verification analyses to determine the safe management of waste to be placed in storage.

Based on the verification analysis, the site management will determine the compatibility of the waste with the storage unit materials of construction and with wastes already stored therein. In addition, stored containerized liquid and solid wastes will be segregated with respect to ignitability, reactivity, corrosivity, and compatibility. Liquid wastes which are transferred from drums, portable tanks or tank trucks may be bulked and placed in bulk storage prior to further treatment.

Waste in Containers (Drums). Stored containerized wastes are segregated with respect to ignitability, corrosivity, reactivity, and compatibility. Appendix V of Part 265, as well as the U.S. Department of Transportation (DOT) Hazardous Precedence List (49 CFR Part 173.2) and the Segregation and Separation Chart of Hazardous Materials (49 CFR Part 177.848), shall be employed for the initial determination of compatibility. The following table lists DOT hazard classes with incompatible hazard classes for wastes in drum storage areas.

TABLE A-4: Incompatible Hazard Classes

Hazard Class	Incompatible Hazard Classes
Flammable Liquid	Oxidizer, Organic Peroxide
Flammable Solid	Corrosive, Oxidizers
Oxidizer or Organic Peroxide	Corrosive, Flammable Liquid, Flammable Solids
Corrosive	Oxidizer, Organic Peroxide Flammable Solids

Based on the initial hazard determination and final identification of the waste, the drummed waste is organized into segregated storage areas. Flammable, corrosive and oxidizing waste materials are kept separate from incompatible materials by storage in separated, walled off/bermed areas within the drum storage unit.

Waste in Tanks. Liquid wastes delivered in bulk form by tank trucks or decanted from drums or portable tanks are placed in bulk storage tanks or directly into reactors prior to further treatment. Prior to transferring any different waste(s) into a storage tank, the compatibility of the waste with the material already in the tank will be determined by the liquid waste compatibility test. Following routine screening, specific storage and process compatibility will be determined. The parameters that will be used to determine compatibility are as follows:

- Stratification – The general miscibility of the materials will be examined. If stratification would appear to create a problem, the materials will not be combined.
- Heat Generation – Materials that upon mixing would generate sufficient amounts of heat or undergo exothermic reactions strong enough to exceed the design capability of the storage unit shall not be combined.
- Gas Evolution – Materials that upon mixing liberate flammable, explosive or toxic vapors, fumes or mists in quantities of concern, shall not be combined unless the storage unit is designed with appropriate engineering controls.
- Undesirable Reactions – Materials that upon mixing result in the formation of a large amount of precipitate or in the solidification or gelling of the mixture shall not be combined.

A-4.2.2 Stabilization

For the purpose of this discussion, treatment will include, at a minimum, stabilization of waste, and in some instances, will include a pre-treatment step prior to stabilization. The pre-treatment may include using other reagents such as oxidizing or reducing agents to chemically convert constituents into a form more suitable for stabilization.

Incoming wastes to be stabilized before disposal will be subjected to the mandatory verification. The pre-treatment analyses also will include a bench scale development of a recipe suitable for achievement of these standards. This recipe will be analyzed using the

appropriate test method (e.g. TCLP., etc.) to demonstrate that the LDR waste can be treated to meet the appropriate standard of prohibition and to establish the treatment guideline to be used on the waste. In addition, compression strength testing may be performed to demonstrate the strength of the treated waste. The treatment guidelines, established during the procedure, demonstrated to achieve the appropriate treatment standard, will be used to treat that LDR waste. In lieu of bench scale recipe development a previously developed and established recipe may be identified for use (e.g., recipe utilized on a similar waste).

Stabilization operations may involve combining multiple waste streams or shipments, i.e., to optimize treatment volume. Wastes to be combined will be selected based on their chemical matrices, EPA codes and recipe requirements. For waste tracking purposes, the treatment residue will carry all waste stream identities (profile numbers and shipment identities, i.e., work order number, manifest number, etc.). For batches with multiple EPA codes, the combined most restrictive standards will apply to the treated residue.

A-4.2.3 Landfill Disposal

A sampling/analysis program is an integral part of this phase of operation. The results of this program serve to evaluate compliance with site permit conditions, confirm disposal method selection, and determine safety constraints. Incoming wastes for which the generator or treater has certified compliance with the LDR standards, as well as batches that have been stabilized onsite by ACE facility, will be subjected to the "Suitability for Landfill" analyses. See Table A-1 in Section A-4 for these analyses. The "Suitability for Landfill" testing is conducted to assure that the treatment process continues to be effective in meeting the treatment standards.

For wastes that have been stabilized by ACE onsite, each batch will be analyzed for Landfill Suitability.

For stabilized waste that is shipped to ACE for which the generator or treater has certified full compliance with LDR treatment requirements, each shipment will be analyzed for Landfill Suitability (i.e., 100% testing of shipments). This frequency can be decreased if 10 successive shipments or batches meet all applicable LDR standards. Specifically, it can be decreased such that 1 in 10 shipments is analyzed for all required parameters and every shipment is analyzed for an indicator parameter to confirm treatment effectiveness. However, if any shipment fails to meet the treatment standards post-treatment, 100% testing must be resumed until 10 successive shipments meet all applicable LDR standards. ACE will identify the specific offsite sources and waste profiles associated with the failed shipment and ensure that 100% testing is applied to them.

An Additional Review Program (ARP) is used to further monitor incoming waste shipments destined for the ACE facility landfill. Ten percent of shipments per month will be selected randomly by on-site personnel as requiring additional review (not to exceed 20 shipments/month). In addition onsite personnel may request additional review using the sampling and analytical protocols from the ARP listed in this permit. Any additional request

will be justified by the state Director in writing. For the bulk solids, a composite will be taken as described in Section A-8. The sample will be of sufficient volume to allow a split sample to be supplied to the state Director. If a shipment of containers is selected, a 10% composite of each profile destined for the ACE facility landfill on the load may be identified for additional review. Further compositing of similar waste streams may be allowed with state Director approval.

The Additional Review Program (ARP) samples are analyzed as follows:

RCRA Hazardous Wastes with Numerical (Concentration Based) LDR Treatment Standards

- Sample will be analyzed for constituents listed for each EPA code associated with the shipment for which numerical LDR standards have been promulgated. Additional analyses may be requested by site management if justified, to address areas of concern. Examples of these analyses include:
 - TCLP metals
 - PCB
 - Volatiles
 - Semivolatiles
- Wastes that are to be stabilized on-site will have their compliance with LDR standards verified according to the frequency specified in this WAP.
- Loads destined for stabilization will be managed under site SOP for testing stabilized residuals. Loads not requiring stabilization will be tested for LDR TCLP metals and volatiles (e.g., Method 8240) with routine site detection limits. Other organics of concern may be requested based on agreement by site management and state Director.
- Due to the extensive listing of constituents, F039 ARP samples will be tested for routine volatiles, semivolatiles and the characteristic TCLP metals.

Non-Hazardous Waste and Waste Without LDR Standards

- TCLP metals: lead cadmium and chromium -these are very frequently found industrial metals and a broad random screen is justified. The other five regulated TCLP metals may be requested by site management if there is a concern about their presence based on information on the waste profile.
- PCB oil bearing waste as determined by a review of the waste profile will be tested.
- 2% Organic Limit Analysis (OLA) - a GC/FID screen is run for priority pollutants except on oil bearing wastes. If petroleum hydrocarbons are identified in the scan, they may be quantified by calculation as nonane. GCMS analysis may be used for confirmation as needed. Alternately, other approved organic analysis methods, such as volatiles by GCMS may be used to determine the concentration of the organic constituents. Organic analysis to verify < 2 % is not required if the state Director has authorized a higher percentage on a case-by-case basis as prescribed.

If unexpected results are obtained during the ARP testing, the generator will be contacted and we will attempt to resolve the issues. Questions will be raised as to the appropriate hazard code classification and application of LDR standards. An update of the profile and the disposal decision may be considered. If the analysis indicates that LDR standards have been exceeded for wastes that are either stabilized off-site or certified as meeting the treatment standards as generated, it shall be reported to the state Director.

No Free Liquids in Landfills

Under no circumstances will ACE allow the placement of bulk or non-containerized liquid hazardous waste or hazardous waste containing free liquids in its landfill. ACE site management will visually inspect each container to ensure that no free liquids are present. If free liquids are detected, the facility will perform a paint filter test (or comparable test required by the state) to confirm the absence or presence of free liquids. If the test indicates their presence, ACE will remove them and perform the test again if necessary. ACE site management also will determine the cause of the free liquids and make needed adjustments to ensure they do not occur again.

A-5 Restricted Wastes

ACE does not accept, for treatment or disposal, any current production waste or outdated products which are listed as hazardous waste by EPA because it contains, as a hazardous constituent (see 40 CFR Part 261, Appendix VII), a form of polychlorinated-dibenzo-dioxin (PCDD) or polychlorinated-dibenzo-furan (PCDF) (e.g., F020, F021, F022, F023, F026, F027, etc.).

ACE also does not accept:

- Radioactive wastes.
- Military or civilian ordnance.
- PCB wastes, as defined by TSCA (greater than or equal to 50 ppm).
- Gaseous wastes in high-pressure cylinders.

A-6 Rejection Policy

The purpose of this section is to set forth the policy and procedures that ACE will use for the acceptance or rejection of waste received by the facility.

A-6.1 Authority

ACE site management has the responsibility of insuring that the appropriate testing of each incoming shipment of waste has been performed. They have the authority for acceptance or rejection of each shipment.

A-6.2 Safety

The transporter delivering waste to the facility will abide by ACE's safety and operational rules and regulations. Transporters will use trucks equipped with safety items and other necessary equipment so the unloading of the materials can be accomplished safely. Inadequate or unsafe equipment is reason for rejection of any shipment.

A-6.3 Scheduling

All incoming shipments of alternative fuels must be scheduled with ACE in advance. A shipment arriving without the necessary pre scheduling may be rejected or significantly delayed.

A-6.4 Documentation

All shipments of incoming waste materials may be accompanied by:

- A manifest that complies with state and federal hazardous waste regulations.
- Any other documentation required for the transport of said materials to the facility.

Incoming shipments arriving without the necessary documentation may be rejected. Exceptions to this case may exist if material handled is shipped by rail and the manifest is mailed separately.

A-6.5 Notification

In the event that an incoming shipment must be rejected, the onsite personnel will give notification to the following entities:

- ACE site management
- Generator
- Transporter

A-6.6 Rejection

A rejected shipment at ACE's facility shall be returned to the generator or the generator's designated alternate facility. The generator will be notified that the shipment has been rejected.

A-7 Discrepancy Resolution

As used in this WAP, a "discrepancy" is either:

- A manifest discrepancy per 40 CFR 264.72, which includes significant differences between the quantity or type of waste designated on the manifest or shipping paper, and the quantity or type of waste the facility actually receives. Significant discrepancies are:
 - For bulk wastes, variations > 10% difference in weight.
 - For containerized waste, variation in piece count.
 - Variations in type discovered by inspection or waste analysis.
 - Rejected waste.
 - Container residue.
- A discrepancy between the chemical or physical properties of a waste received at the facility and its waste profile (e.g., pH that falls outside of its tolerance limits, flammability, etc.). Refer to Section A-9 of this WAP for information on the parameters verified for incoming shipments and examples of discrepancies.

A-7.1 Manifest Discrepancy

All attempts will be made to resolve manifest discrepancy issues with the generator. Resolution will be noted in the operating record. Unresolved discrepancies will be submitted to the Regional Administrator by letter within 15 days from receipt of the incoming shipment.

There may be situations where ACE will accept unmanifested waste shipments. Please refer to 40 CFR 264.76.

A-7.2 Discrepancies Between Waste Received at Facility and Waste Profile

If a discrepancy between the waste received at the facility and its waste profile is identified, ACE will perform the following before acceptance:

Discrepancies

Include provisions in the WAP for both resolving discrepancies and ensuring they do not recur, such as determining if a new or revised waste profile is needed and requiring the generator to submit a corrective action plan.

- The generator is notified and requested to supply additional knowledge to assist in the resolution of the concern(s). If the generator supplies information that alleviates the concern(s) identified, no further action is required.
- The ACE site management and the generator discuss the discrepancy issue and identify the appropriate course of action to resolve the container/shipment in question, i.e., pick another sample set, return the container/shipment, divert the container/shipment to another TSD unit that can accept the container/shipment and resolve the issue, or the generator resolves the issue at the TSD unit. If the discrepancy issue(s) results in the failure of a shipment, the chemical screening frequency for all streams that could exhibit a similar issue(s) from the generator are adjusted to 100 percent until the issue(s) adequately can be addressed.
- On resolution of the initial discrepancy issue, ACE site management requests the generator to provide a corrective action plan (CAP) that clearly states the reason for the failure and describes the actions to be completed to prevent re-occurrence. The generator could request a reduction in verification of additional streams that the generator believes are unaffected. This request must be accompanied by a justification that identifies why this stream(s) would not exhibit the same discrepancy issue.
- ACE site management reviews the CAP and stream justification for adequacy. If the stream justification is adequate, ACE site management could provide an alternative frequency. ACE site management documents these actions and keeps this documentation in the operating record in accordance with Section A-12.

A-8 Sampling Methodology

NOTE: Some portions of Section A-8 have been removed in order to shorten the overall length of this example WAP. This was done **solely** for purposes of presentation in this guidance document.

Sampling is performed by the ACE facility and by (or as directed by) the waste generator at the generator's facility. Specific sampling procedures are dependent on both the nature of the material and the type of containment. SW-846 states that, "a less comprehensive sampling approach may be appropriate if information regarding the distribution of waste components is known or assumed." This section presents sampling methodologies to be utilized on-site by ACE personnel.

When a waste arrives at the facility for management, a determination has previously been made by the generator that the waste is either:

1. a listed hazardous waste in 40 CFR Part 261, Subpart D;
2. a characteristic waste as defined in 40 CFR Part 261, Subpart C; or
3. a non-hazardous waste.

The generator-supplied characterization provides ACE with information concerning both the distribution and nature of the waste components (see Section A-2 for discussion

regarding the information or data to be supplied by the generator). The purpose of the inspection, sampling or analysis when a waste material arrives at the site is to ensure that the shipped waste matches the description of the waste designated on the accompanying manifest or shipping paper and WPS.

Therefore, ACE can often use a less comprehensive sampling approach, as described in Sections A-8.2.1, to yield a waste identification sample (see EPA documents SW-846 “Test Methods for Evaluating Solid Waste”, Third Edition, September 1986, Chapter Nine).

A-8.1 General Methods and Equipment

As practicable, the sampling techniques used for specific types of waste correspond to those referenced in 40 CFR 261, Appendix I and presented in Table A-5. Because Appendix I sampling methods have not been formally adopted by the EPA Administrator, ACE may modify the technique as necessary to obtain a representative sample. Any changes made after final permitting will be forwarded to the state Director for review and acceptance. The sampling equipment and procedures described in this WAP represent the facility’s recommended sampling protocol for general types of waste material and containment. Specific waste materials or shipments may require different sampling techniques. Therefore, deviations from the recommended protocol do not constitute an excursion from acceptable sampling practices or the conditions of this WAP. All methodologies will be updated and revised as the references are updated and revised.

A-8.2 Specific Methods and Equipment

In addition to ASTM and EPA sampling procedures, ACE has instituted specific methodologies for taking samples from various containment sources. The type of container may be transportable (e.g., such as drums), portable transport units (e.g., tanks, roll-off boxes), and tanker or dump trucks; or stationary, such as tanks, in-process sources, waste piles, and containments. The sampling devices are selected depending on the size and type of containment and on the specific material involved. The device to be used in each situation is described below.

Access to any type of container will influence the location within the container from which samples can be taken. Samples will be taken to address vertical variations in the waste because there is a much greater tendency for wastes to be heterogeneous in a vertical rather than a horizontal direction, and horizontal variations are generally easier to detect if examination indicates strata in the waste, then each layer may be composited in proportion to its estimated volume or sampled individually.

TABLE A-5: Sampling Methods and Equipment

Material (or waste type)	Method	Equipment
Extremely viscous liquid	ASTM D140 ^a ASTM E300 ^a	Tubing, thief or Coliwasa
Crushed or powdered material	ASTM D346 ^a ASTM E300 ^a	Tubing, trier, scoop, or shovel
Soil or rock-like material	ASTM D420 ^a ASTM E300 ^a	Tubing, trier, auger, scoop, or shovel
Soil-like material	ASTM D1452 ^a ASTM E300 ^a	Tubing, trier, auger, scoop, or shovel
Fly ash-like material	ASTM D2234 ^a ASTM E300 ^a	Coliwasa, tubing, weighted bottle, bomb, or tank sampling port
Containerized liquids	SW-846B or ASTM E300 ^a	

a American Society for Testing Materials. Annual Book of ASTM Standards. Philadelphia, PA. 1982 or most recent edition.

b Test Methods for Evaluating Solid Waste: Physical/Chemical Methods, SW-846, Third Edition, U.S. Environmental Protection Agency, Office of Solid Waste, Washington, DC, September 1986, as amended by all recent updates.

A-8.2.1 Containers and Tanks

A container is a portable device in which a material is stored, transported, treated, disposed of, or otherwise handled. The sampling of small containers (e.g., drums, cartons, and other small units) varies with the physical nature of the waste material. For flowable materials, the sampling device of choice is either a Coliwasa unit or open tube sampler, which is used to draw a full vertical section. Drums of aqueous and organic liquids are sampled with a four foot glass tube. A composite sample may be obtained by mixing equal portions of each container included in the sampling lot. Solids or sludges or other small containers are sampled with a scoop (disposable plastic or using the bottle itself) or a shovel if a heavy digging tool is required. If the material on top appears non-representative (e.g., “speedy-dry”, “oil dry”, etc.), a subsurface sample will be obtained. The top portion may be transferred to another container in order to obtain a subsurface sample. Alternately, a metal sample thief, trier or tubing (a piece of conduit or small diameter pipe) may be used to obtain a core sample of the drummed solid.

A-8.2.2 LDR “Grab” Sampling

The Land Disposal Restrictions, 40 CFR 268, have specified the use of “grab” sampling for most of the compliance demonstrations to the Land Disposal Restrictions BDAT treatment standards.

A-9 Parameters and Analytical Methods

NOTE: The text and table in this section have been shortened in order to reduce the overall length of this example WAP. This was done **solely** for purposes of presentation in this guidance document.

The parameters which constitute the analyses performed by ACE facility are identified in Table A-6. ACE will use either SW-846 or ASTM methods for each parameter, as shown in the table. ACE has its own laboratory SOPs which the laboratory follows. The analytical parameters and techniques used by ACE through its operating experience have been chosen for their ability to provide the information required to properly manage a waste.

TABLE A-6: Analytical Parameters, Reference Methods, ACE Method, and Rationale

Parameters	Reference Methods	ACE Method #	Reason
Physical Description	Not applicable	Visual Inspection	Verification and system compatibility
pH Screening	SW-846 9045 ASTM D4980	ACE-4	Verification and system compatibility
PCB Screening	SW-846 3580 SW-846-8000 SW-846 8082	ACE-3	Prohibited material
Suitability for Landfill ^a	SW-846 1311	ACE-6	Verification and system compatibility
Water Screening Mix	ASTM D4982	ACE-10	Verification and system compatibility
Flammability Potential Screening	ASTM 505	ACE-7	Verification and system compatibility

^a Suitability for Landfill involves mandatory verification, a leachable metals assessment if the waste contains metals, as well as additional tests if needed (e.g., tests for cyanides). This row of the table addresses only to the leachable metals assessment (i.e., Toxicity Characteristic Leaching Procedure).

Following is a discussion of the method(s) and rationale for each parameter:

- Physical Description** is used to determine the general physical characteristics of the waste (e.g., color, waste form). This facilitates subjective comparison of the waste with prior waste descriptions or samples.
- pH Screening** is undertaken to indicate the pH range and the general corrosive nature of the waste. pH screening may not apply to certain waste types, e.g., organic waste, or insoluble solid waste. For each approved waste stream, tight tolerance limits (e.g., +/- 2 pH unit change) will be established based on the operating requirements of the relevant treatment and disposal systems at the facility and other relevant considerations. If the pH of an incoming shipment falls

Tolerance Limits for Fingerprint Tests

The purpose of the fingerprint tests is to verify that the shipment matches its manifest and waste profile. Consider establishing tolerance limits for one or more parameters such that verification can be made objectively (see pH screening).

outside of this range, re-qualification will take place to review the waste and update its WPS.

- PCB Screening is used to ensure that no materials are stored or used at the facility that would require a Toxic Substances Control Act permit. PCB wastes, as defined by TSCA (greater than or equal to 50 ppm), will not be accepted at the facility.
- Suitability for Landfill is a testing program that assesses the acceptability of the stabilized waste for land disposal. All stabilized wastes to be disposed of in the ACE landfill are subjected to mandatory verification, a leachable metals test if applicable, as well as additional tests deemed appropriate. Waste streams that are to be land disposed after being stabilized are classified into general categories.
 1. Inorganic solids and sludges with no RCRA metals (e.g., calcium fluoride, sulfate, and phosphate mixture)
 - Mandatory verification.
 2. Inorganic process sludges and solids with metals (e.g., WWT sludges with F and D codes)
 - Mandatory verification.
 - Leachable metals assessment.
 3. Soil or other inorganic solids with metals (e.g., fly ash with lead, 0 code materials)
 - Mandatory verification.
 - Leachable metals assessment.
 4. Inorganic solids with cyanide, which may include metals (e.g., potliner)
 - Mandatory verification.
 - Leachable metals assessment may be performed.
 - If cyanide screening is positive, analyze for cyanides amenable to chlorination or total cyanide to determine whether the waste qualifies for land disposal.
- Water Mix Screening is used to determine whether the waste has a potential to vigorously react with water to form gases or other hazardous products, or whether it generates significant heat. This testing does not apply to wastes that are already in contact with excess water, or for which sufficient analytical data exist that indicate no potential reactivity with water.
- Flammability Potential Screening is used to indicate the fire-producing potential of the waste. This testing can be applied to all waste liquids, semi-solids, but need not be applied if other information (e.g. WPS in conjunction with the results of the other screens, SDS, etc.) indicates the waste is not ignitable.

A-10 Quality Assurance /Quality Control

A-10.1 Introduction

The following Quality Assurance/Quality Control (QA/QC) information for the ACE facility is being provided as required by 40 CFR 270.30(e) and in accordance with the following EPA guidance documents.

QA/QC procedures are applicable to both sampling procedures and analytical techniques. QA/QC information for these two elements of the waste analysis program has been included in this Waste Analysis Plan (WAP) as recommended in the waste analysis plan guide manual.

This section does not provide specific performance standards or quality control procedures for individual sampling and analysis techniques. Such specifics are defined on a corporate-wide basis for all ACE facilities. The specific performance standards are dynamic and are revised as warranted to reflect technological advances in sampling and analytical techniques. ACE QA/QC policies are found in the corporate Quality Assurance and Control Policies, portions of which have been extracted and included in the following sections. The performance standards will be available for review at the facility.

A-10.2 Sampling Program

Sampling procedures for specific facility operations are described in Section A-8 of the WAP. The selection of the sample collection device depends on the type of sample, the sample container, and the sampling location. The selection and use of the sampling device is supervised by the QA Manager, who is thoroughly familiar with both the sampling and analytical requirements. The type of device to be used in the various sampling situations is speed in Section A-8.2, Specific Methods and Equipment.

Sampling equipment is constructed of non-reactive materials such as glass, PVC plastic, aluminum, or stainless steel. Care is taken in the selection of the same pier to prevent contamination of the sample and to ensure compatibility of materials. The specific material of construction to be used for each sampling activity is specified in Section A-8.2.

Sampling is performed for each waste stream in a manner that ensures the samples are as representative as possible under the conditions of the sampling event. Full vertical sections are drawn from tanks and containers, where appropriate and where access allows, as described in Section A-8.2.

With a few exceptions, all bulk and containerized waste loads will be sampled (see Section A-4). Container samples that are related to one generator and waste profile may be composited prior to analysis, provided that individual samples are similar in physical appearance. Precautions are taken to minimize loss of volatiles.

All samples must be appropriately labeled. No field notebook is used in sampling hazardous waste shipments or process samples. Anything unusual noted during sampling would be noted in the comments area of the label. No chain of custody form is employed within the plant. The samples are turned directly into the lab. A chain-of-custody will accompany any sample being sent to a contract lab. Sampling information is entered into the facilities operating record.

Hazardous waste samples are generally not amenable to preservation. For samples collected at ACE for organic analysis, the preservation and holding times will be in accordance with Chapter 4 of SW-846. Samples for 2% Organic Limit Analysis screen will generally be analyzed within 14 days. For treated wastewater samples from the plant, metals aliquots are preserved by the addition of HNO₃ to pH <2 and cyanide aliquot is preserved by the addition of NaOH to pH > 12. After TCLP extraction for leachable metals an aliquot for metals is fixed by adding HNO₃ to pH < 2.

A-11 Data Reporting

ACE will report discrepancies to EPA if they are not resolved within the timeframes specified at 40 CFR 264.72. In addition, ACE will supply any analytical data to EPA when requested. This includes the following information, which must be kept at the facility:

- Receiving Papers – Date, time, sample ID, customer name, stream ID, and sample receipt/delivery.
- Worksheet Raw Results – For each test (instrument readings, sample weights, etc.), date, initials of analyst, and sample ID.
- Sample Master Logbook – Date, sample ID, type, initials, result, etc.
- Calibration and Performance Sample Results – Initials, result, results of calibrations, duplicates, known standards, blanks, blind samples, and reference samples. QC results are compiled and each set of results will be compared with QC limits, and records should show the basis for QC limits.
- Instrument Maintenance and Repair Record On the Following Analytical Systems – ICPs, GCs, calorimeters, ion chromatographs, and Hg analyzer.

A-12 Recordkeeping

ACE maintains the Laboratory Information Management System (LDMS) to automate the waste disposal process using comprehensive application software packages. The system automates the major aspects of waste treatment and disposal (waste analysis data, discrepancies, corrective actions, etc.) to improve the efficiency and minimize data errors. Waste tracking, laboratory data management and process control interface are major components of waste disposal that are automated by the LDMS.

A complete set of records will be maintained at the facility for each generator, including information generated during pre-acceptance, acceptance, and waste treatment. This information will include, but not be limited to:

- WPS
- Pre-qualification analysis
- SDSs (if available)
- Generator laboratory analysis (if available)
- Sample log sheets
- Photocopy of each manifest
- Records demonstrating compliance with, and decisions made under the analyses performed by ACE facility. In particular, a record of all analyses will be maintained by ACE for each waste sampled/analyzed, as part of the facility operating record. The mandatory and supplemental analyses records will include:
 - A copy of the chain of custody document
 - Copies of all applicable analytical and test results and lab reports including the results of the mandatory analysis
 - A copy of the original (incoming) manifest
 - A copy of the original WPS
 - Documentation of any discrepancies identified by verification analyses
 - If applicable, a copy of any written or correspondence with the generator related to resolving a WPS discrepancy and documentation of relevant conversations with the generator regarding same.
 - If applicable, copies of any written correspondence with the generator and state Director related to resolving a manifest discrepancy and documentation of relevant conversations with the generator or state Director regarding same.
 - If applicable, a copy of the revised WPS
- Records documenting ACE's records to resolve discrepancies between an incoming waste and its waste profile.

In addition, ACE will produce bi-annual reports that summarize the following for state inspector review:

- The frequency at which incoming shipments do not conform to their waste profiles. The report must indicate the steps taken by the facility to evaluate and resolve the discrepancies, including if new or revised WPSs were produced.

Facility-Prepared Reports

When preparing the WAP, include provisions to assist regulators during compliance inspections, such as facility-prepared reports summarizing key problems and difficulties encountered.

- The frequency at which treated wastes do not meet the LDR treatment standards. The report indicates the steps taken by the facility evaluate the incoming wastes and treatment process to resolve failures.

All waste analysis records will be kept as a part of the facility operating record and will be maintained as required by law.

A-13 Corrective Action

While the goal of the ACE QA/QC program is to provide sufficient training, equipment, facilities, technical support, and supervisory oversight to avoid inadequate measurements or data, it is recognized that data quality can fall outside established limits for a variety of reasons. The program provides for reporting and reviewing procedures that permit early and effective corrective action should it be needed. Specifically:

- All samples are registered and tracked via an electronic Laboratory Data Management System (LDMS) to ensure that the necessary analyses are performed.
- Data generated each day are entered into appropriate logbooks and the LDMS tracks each sample. These systems provide an opportunity for quick review of the data to see if the various results are internally consistent. Apparent discrepancies are brought to the attention of site management.

The site management reviews completed data information on all samples prior to shipment receipt. This data is then filed for future reference.

If problems are found, several corrective actions are considered depending on the apparent source. These include, but are not limited to:

- Re-sampling
- Re-analysis of the sample
- Performance audit of the analyst
- Systems audit
- Inter laboratory comparison study
- Review of SOP for error or inadequacy.

Appendices

NOTE: The information in the appendices has been omitted to reduce the overall length of this example WAP. This was done **solely** for purposes of presentation in this guidance document.

Appendix A-1 Waste Profile Sheet

The waste profile sheet (WPS) has been removed from this WAP. See Figure 2-9 of this manual for an example of a WPS.

Appendix A-2 Overview of the Pre-Acceptance Process

The overview has been removed from this WAP. See Section 1.2 of this manual for a discussion of the pre-acceptance process.

Appendix A-3 Overview of the Incoming Load Process

The overview has been removed from this WAP. See Section 2.9 of this guidance for a discussion of procedures for handling incoming loads.

Appendix A-4 Aqueous Waste Treatment

The diagram of aqueous waste treatment has been removed from this WAP.

Appendix A-5 Landfill and Stabilization

The diagram of landfill and stabilization has been removed from this WAP.

Example WAP 2: Waste Analysis Plan of Container Management Incorporated (CMI)

Table of Contents

1.0	General Overview	4-36
2.0	Waste Prequalification Procedures.....	4-37
2.1	Waste Information Profile (“WIP”)	4-37
2.2	Determination of Outbound Designated Facility	4-38
2.3	Lab Pack Waste	4-38
3.0	Acceptable Waste Codes	4-38
4.0	Analysis and Acceptance	4-38
4.1	Level I Analysis	4-40
4.2	Level II Analysis:	4-41
4.3	Level III Analysis:	4-42
4.4	Final Acceptance and Placement of Waste in Storage	4-43
5.0	Restricted Wastes	4-43
6.0	Rejection Policy.....	4-43
7.0	Discrepancy Policy	4-44
7.1	Manifest Discrepancies	4-44
7.2	Discrepancies Between the Waste and WIP	4-44
8.0	Outbound Waste Screening Procedures.....	4-45
9.0	Waste Sampling	4-45
9.1	Sampling Methods	4-46
9.2	Sample Tracking Documentation	4-46
9.3	Sampling Personnel	4-46
9.4	Sample Labels.....	4-46
10.0	Parameters and Rationale	4-47
11.0	Test Methods.....	4-48
12.0	Quality Assurance and Quality Control	4-52
12.1	Sampling Program	4-52
12.2	Analytical Program	4-52
12.3	Conclusion	4-53
13.0	Recordkeeping and Reporting	4-53
14.0	Corrective Action	4-54

Appendices 4-55

- Appendix C: Standard Operating Procedures for Opening and Sampling Containers 4-56
- Appendix D: Bulk Consolidation Tracking Sheet 4-57
- Appendix F: Example Level I QA/QC Report 4-58
- Appendix G: Level II/III QA/QC Checklist 4-59

DRAFT

1.0 General Overview

Pursuant to 40 CFR 270.14 (b)(3), a hazardous waste management facility is required to develop and follow a Waste Analysis Plan (WAP) that meets the requirements of 40 CFR 264.13 (b) and (c). This waste analysis plan establishes the following:

- The procedures for qualifying, accepting and analyzing the contents of each waste container managed at Container Management Inc. (“CMI”).
- The waste analyses and supplemental information that hazardous waste generators or their authorized agent (customers) will supply.
- The frequency at which analysis of waste will occur to ensure that waste is characterized accurately.
- Procedures for handling discrepancies and rejected shipments.
- The methods used to obtain a representative sample of waste to be analyzed.
- The parameters for which each waste will be analyzed and the rationale for selecting these parameters.
- The test methods used to test for each parameter.
- A quality assurance/quality control (QA/QC) program for waste sampling and analysis, along with a corrective action program.
- The recordkeeping and reporting procedures associated with this WAP.

Emphasis is placed upon obtaining accurate information about the chemical and physical makeup of each waste received by CMI. This information, which is to be detailed in a waste-specific Waste Information Profile (WIP) maintained as part of the facility record, may be based on the generator knowledge of the waste and/or chemical and physical analyses of a representative sample of the waste.

CMI accepts “containerized” and “bulk” waste for storage prior to consolidation and/or shipment off-site. Wastes managed by CMI may be regulated under the Resource Conservation and Recovery Act (RCRA), the Toxic Substances Control Act (TSCA), Superfund (CERCLA), and the state’s Hazardous Waste Management Regulations (HWMR). CMI accepts wastes in a variety of physical forms, including liquids, sludges, solids, and compressed gases. For the purposes of this WAP, “containerized” waste is waste managed in containers that can be moved manually or with a forklift (e.g., U.S. Department of Transportation (“U.S. DOT”) approved shippable containers, drums, pails, bags, boxes, pallets, ton sacks, flasks, cylinders). “Bulk waste” is received and shipped in accordance with applicable U.S. DOT regulations.

CMI also accepts “lab packs” which are containers that hold a variety of chemicals, products or small quantities of laboratory samples. Each lab pack container is repackaged in

accordance with applicable U.S. DOT regulations that are based on compatibility, content, and size of individual samples. An inventory-packing list accompanies each lab pack container and identifies, among other things, the content, quantity and size of each container within the lab pack, and applicable RCRA and state-specific hazardous waste code(s). See **Appendix B** of this WAP for an example Lab Pack form.

CMI also accepts “bulk or consolidation packs” that are containers that hold one type of material (e.g., paints). Each bulk or consolidation pack container is prepackaged in accordance with applicable U.S. DOT regulations.

2.0 Waste Prequalification Procedures

All waste accepted by CMI must be approved through the prequalification process. As described below, the prequalification process requires completion of a Waste Information Profile (WIP) by the generator or their authorized agent, and review and approval of the WIP by CMI.

2.1 Waste Information Profile (“WIP”)

A WIP must be completed, signed and submitted by the waste generator or the generator’s authorized agent for each waste received by CMI. A sample of the waste may be necessary for prequalification purposes.

Each WIP is reviewed by CMI to determine if CMI can accept the waste. The CMI WIP form is included in **Appendix A** of this WAP. A generator may use a different WIP form, provided the form is reviewed by CMI and found to be equivalent to the CMI form.

Based on the sample and information provided in the WIP, a CMI Supervisor or Senior Waste Technician may either approve the WIP or determine that additional information is necessary prior to approving the waste. A WIP shall not be approved if any pertinent section of a WIP is omitted; an inconsistency is identified on the WIP (e.g., acidic solution with pH 14); the generator does not provide sufficient information about the waste generating process and/or materials used in the process.

In the event that a WIP is not approved, additional information (e.g. SDS) must be provided or the waste must be analyzed further before the WIP can be approved by CMI. The WIP shall document the use of generator knowledge and/or analysis in making a hazardous waste determination. All supporting documentation must be included with the copy of the WIP maintained at the CMI facility. Any completed WIP for waste that is unused “product” material, with the exception of household-generate wastes and waste contained within lab packs, must include a Safety Data Sheet. In all cases, if the CMI Supervisor or Senior Waste Technician is not confident that a waste has been characterized accurately, he or she shall not approve the WIP.

Upon approval of a WIP, the CMI Supervisor or Senior Waste Technician shall ensure that the applicable CMI “process code” and CMI “approval code” information is added to the top of the WIP form.

Each WIP must be reviewed by the generator or the generator’s authorized agent on an annual basis. Following this review, the generator or authorized agent must provide a signed statement to CMI that either certifies the waste generating process and the chemical and physical characteristics of the waste remain unchanged or specifies any changes to the waste or generating process. If a signed certification statement is not returned to CMI, the WIP will be canceled.

2.2 Determination of Outbound Designated Facility

As part of the prequalification process following WIP approval, the CMI Supervisor or Senior Waste Technician also selects a designated facility to which CMI will likely ship the waste after the waste has been received by the CMI facility. Selection of the designated facility is based on the WIP, assigned RCRA and state-specific hazardous waste codes, any applicable land-disposal restriction regulations, generator request/requirement, and any requirements or restrictions of the designated facility’s permit or license. Upon selection of a designated facility, approved waste may be scheduled for transport and delivery to CMI.

2.3 Lab Pack Waste

In addition to the prequalification requirements described in sections 1.1 and 1.2, above, for each lab pack waste stream, the CMI Supervisor or Senior Waste Technician must review and approve a packing list compiled for each lab pack container using the Lab Pack Contents Form (see **Appendix B** of this section). If any incompatible or unacceptable material is listed on the Lab Pack Contents Form, the generator or generator’s agent is given the option of either properly repacking that material or having the lab pack container rejected by CMI.

3.0 Acceptable Waste Codes

This facility is permitted to accept the vast majority of RCRA hazardous waste codes in the state’s Hazardous Waste Regulations. See Part A of this permit for a full list of the codes that CMI is permitted to accept.

4.0 Analysis and Acceptance

When a shipment of waste (containerized waste, bulk waste, and/or lab packs) arrives at the CMI facility, a CMI Supervisor or Senior Waste Technician is responsible for either receiving or rejecting the waste upon completing the following procedure:

- Review the manifest or shipping paper for accuracy and completeness

- Unload containers to the CMI waste receiving area (i.e., Cell A-1)
- Check container labels for completeness and consistency with the WIP
- Check the condition of each container and verify that it is U.S. DOT-approved
- Verify that each container type is consistent with the information on the WIP, manifest and waste stored therein
- Assign a unique container number to each container using the facility computer system, and affix a sticker marked with that unique number to the container
- Perform the Level I waste analysis procedure described below
- If applicable, perform the Level II and Level III waste analysis procedures described below

CMI will utilize a tiered approach for analyzing incoming shipments at the facility. A Level I analysis will be performed on each shipment received. Level II analysis will be performed when the Level I analysis indicates unresolved discrepancies between the waste and its WIP. Level III analysis will be applied to all containers received on a periodic basis (e.g., to evaluate the accuracy of the WIPs maintained by CMI). Table 1 gives an overview of these analyses and Table 2 summarizes their frequency. Refer to Sections 4.1 through 4.3 of this WAP for additional information on the Level I, II and III analyses.

TABLE 1: Analyses Performed by CMI Facility

Parameters	Pre-Qualification	Incoming Shipments ^a		
		Level I	Level II	Level III
% Liquid % Solid % Sludge by content	X	X	NA	NA ^b
Color	X	X	NA	NA ^b
Viscosity	X	X	NA	NA ^b
pH Screen, except solid and non-aqueous wastes	X	X	X	X
Water Reactivity	X	NA	X	X
Reactive Sulfides Screen	X	NA	X	X
Ignitability	X	X ^c	X	X
Reactive Cyanides Screen (Spot Test)	X	NA	X	X

a. As used in this table, NA = not applicable

b. These parameters are analyzed under Level I.

c. If the evaluation of waste properties indicates that the waste is potentially ignitable, CMI will screen the waste for flash point utilizing a bench-top screening procedure.

NOTE: Table 1 has been shortened in order to reduce the overall length of this example WAP. This was done solely for purposes of presentation in this guidance document.

TABLE 2: Frequency of Analysis

Pre-Qualification	Incoming Shipments		
	Level I	Level II	Level III
Each waste will be sampled, with limited exceptions	<ul style="list-style-type: none"> ▪ Visual inspection of each bulk load and container 	If Level I analysis identifies a discrepancy	The contents of 1 out of every 500th container

	<ul style="list-style-type: none"> ▪ Sampling of each bulk load ▪ Sampling of each container in a shipment, except that: <ul style="list-style-type: none"> – In the case of multiple containers of the same profiled waste, 1 sample will be taken from 1 out of every 10 containers – Samples will not be taken for specified wastes^a 	<p>between the waste and WIP and it cannot be resolved with the generator, a Level II analysis is performed ^b</p>	<p>of waste (including solid and non-hazardous waste) received by CMI will be sampled and tested</p>
--	---	--	--

a. Exceptions are for lab packs and non-sampleable wastes (e.g., fluorescent lamps).

b. Alternatively, the waste can be rejected back to the generator or forwarded to an alternative TSDF.

4.1 Level I Analysis

The CMI Supervisor or Senior Waste Technician will open and inspect each container and bulk load in the waste receiving areas (i.e., Cell A-1 for containers, and within the outdoor secondary containment bays for bulk loads). With the exception of multiple containers of the same waste (i.e., waste described by the same WIP and that appear consistent upon visual inspection), Lab Packs, and other “non-sampleable” wastes (e.g., fluorescent lamps, batteries, PPE), a sample will be collected from each container and bulk load in accordance with the facility’s Sampling SOP (see **Appendix C** of this section) for the purpose of performing Level I analysis. In the case of multiple containers of the same waste, each container will be opened to visually confirm consistency between waste in the various containers, but only a single sample will be collected from one of every ten containers received. For lab packs, the content of each container is compared to the Lab Pack Contents Form.

Upon opening each container, the waste will be visually compared to information on the container label, manifest, and WIP. For liquids and semi-solids, a thief/tube will be used to check for layering and, if applicable, to determine the approximate percentage of each layer. The collected sample will be evaluated for the following properties:

- % Liquid, % Solid, % Sludge content (by CMI-1 method)
- Color (CMI-1)
- Viscosity (CMI-1)
- pH (CMI-2), except for solid and non-aqueous wastes

If the evaluation of waste properties indicates that the waste is potentially ignitable, CMI will screen the waste for flash point utilizing a bench-top screening procedure (CMI-5). Waste streams that are potentially subject to flash point screening include: non-lab pack wastes,

non-virgin products, and liquid wastes that are not already characterized as exhibiting the characteristic of ignitability (D001).

The results of the visual inspection and sample evaluation will be compared to the WIP. If the Level I analysis identifies a discrepancy with the WIP, CMI will immediately contact the generator or the generator's agent and attempt to resolve the discrepancy.

Any waste that does not conform to the WIP will be quarantined in Cell A-1. If the discrepancy is resolved by contacting the generator, the waste will be moved to an appropriate storage cell by the end of the work shift. If the discrepancy cannot be resolved by the generator, CMI will follow the Level II procedure below, and the waste will remain quarantined in Cell A-1.

Level 1 analysis is documented using the Level I QA/QC report (see Appendix F of this WAP).

4.2 Level II Analysis:

If the Level I analysis identifies a discrepancy with the WIP, and the discrepancy cannot be resolved, then CMI will perform Level II analysis of the waste, reject the waste back to the generator, or ship the waste to an alternate TSDF in accordance with the Discrepancy Policy in Section 7.0 of this WAP. CMI will make every effort to resolve the discrepancy and accept the waste. The state's Waste Management Division will be notified of any wastes rejected back to generators in the state, as described in the Rejection Policy in Section 6.0 of this WAP. Level II analysis includes the following tests, as appropriate:

- pH
- Water Reactivity
- Reactive Sulfide Spot Test
- Ignitability
- Reactive Cyanide Spot Test
- Oxidizer Screen
- Specific Gravity
- % Suspended Solids
- Chlorine Spot Test
- Polychlorinated Biphenyl (PCB) Screen
- Flash Point
- Free Liquids/Paint Filter Test
- RCRA 8 metals
- Volatile Organics
- Any other parameter deemed necessary

Any waste that is subject to Level II analysis will be quarantined in Cell A-1 until the discrepancy with the WIP is resolved.

Level II analysis will be subcontracted to an independent state certified or NELAC laboratory that uses ASTM and/or SW-846 analytical and test methods. The results of all Level II analyses will be documented in a log (see **Appendix G** of this WAP) maintained as part of the facility operating record.

4.3 Level III Analysis:

CMI will select and analyze waste samples received at the facility as follows:

The contents of one out of every 500 containers of waste (including solid and non-hazardous waste) received by CMI will be sampled and tested according to this Level III analysis procedure. CMI's container tracking system will be used to identify every 500th container received by CMI in sequential order. In the event that the contents of the 500th container cannot be sampled (e.g., batteries, CRTs, lamps, lab packs, etc.), or is verified to be either an unused "product" material (SDS available) or household hazardous waste, CMI will count forward (i.e., 501st, 502nd, etc.) until a container of waste is located that can be sampled. CMI will document the unique container number(s) of each waste container that is by-passed in the facility operating record along with the rationale for by-passing each container.

On an annual basis, CMI will review the Level III analysis procedure and the previous year's Level III analysis results (i.e., testing data) to ensure that a variety of waste types and customers have been, and will continue to be, represented. This annual review will be documented in the facility operating record. Any potential changes to the Level III analysis procedure that are identified by CMI based on this review should also be documented in the facility operating record.

Once a container is identified for the purpose of conducting Level III analysis, the CMI Supervisor or Senior Waste Technician will collect a sample in accordance with CMI's SOP (see **Appendix C** of this section). In addition to completing Level I analysis and documenting the physical description of the waste, the following parameters will be tested, as appropriate:

- pH
- Water Reactivity
- Reactive Sulfide Spot Test
- Ignitability
- Reactive Cyanide Spot Test
- Oxidizer Screen
- Specific Gravity
- % Suspended Solids
- Chlorine Spot Test
- Polychlorinated Biphenyl (PCB) Screen
- Flash Point
- Free Liquids/Paint Filter Test
- RCRA 8 metals
- Volatile Organics
- Any other parameter deemed necessary

Level III analyses will be subcontracted to an independent state certified or NELAC laboratory that will use ASTM and SW-846 analytical and test methods.

A record of all Level II and Level III analysis will be maintained by CMI for each waste sampled/analyzed, as part of the facility operating record. The Level II and Level III records are described in Section 13.0 of this WAP.

If a WIP is determined to be inaccurate through Level II or Level III analyses, the CMI Supervisor or Senior Waste Technician will review for accuracy all other WIPs corresponding to wastes generated by the generator who submitted the inaccurate WIP.

4.4 Final Acceptance and Placement of Waste in Storage

Upon verification that a containerized waste or bulk waste is consistent with the corresponding WIP, the waste will be moved from the receiving area (Cell A-1) to an appropriate storage cell. Movement to an appropriate storage cell shall occur within the timeframe specified in the state regulations (e.g., 24 hours) from the transport vehicle.

Any waste that does not conform to the corresponding WIP will be quarantined in Cell A-1 until the discrepancy is resolved with the generator. Upon resolution of the discrepancy, the waste will be moved to an appropriate storage cell by the end of the work shift.

5.0 Restricted Wastes

There are few restrictions on the wastes that CMI can accept. We cannot accept:

- Radioactive wastes.
- Conventional or chemical ordnance.
- Gaseous wastes in high-pressure cylinders.

6.0 Rejection Policy

It is the policy of CMI to follow the procedures set forth at 40 CFR 264.72 when managing rejected loads and non-empty containers (i.e., container holding residues that exceed the quantity limits for “empty” containers set forth at 40 CFR 261.7(b)). Specifically, CMI will perform the following actions after a decision is made to reject a waste or residue:

- Obtain or confirm the generator’s directions on where to forward the rejected waste or residue (i.e., either back to the generator or to alternative TSDF);
- While the shipment is waiting to be forwarded, ensure that it is stored securely by the delivering transporter or by CMI . CMI will secure the waste in Storage Unit 22, which is a fenced area with drainage and protection from weather;
- Send the rejected waste or residue off-site within 60 days, if applicable;
- Ensure the rejected load or residue is re-manifested in accordance with 40 CFR 264.72(f)-(g); and
- Maintain records of the above actions. Refer to Section 13.0 of this WAP for recordkeeping.

7.0 Discrepancy Policy

CMI will adhere to the following procedures when attempting to resolve discrepancies.

7.1 Manifest Discrepancies

A manifest discrepancy is defined at 40 CFR 264.72 as significant differences between the quantity or type of waste designated on the manifest or shipping paper, and the quantity or type of waste the facility actually receives. It also includes rejected wastes and container residues. CMI will follow the procedures in section 264.72 to address manifest discrepancies:

- Attempt to resolve the discrepancy (e.g., by calling the generator);
- If the discrepancy cannot be resolved within 15 days, send a letter immediately to the state's Waste Management Division describing the discrepancy and attempts to resolve it, along with a copy of the manifest at issue;
- Decide if the waste can be accepted by CMI despite the discrepancy. This involves a determination whether CMI can manage the waste on-site in a manner that is safe, effective and in accordance with the provisions of its permit;
- If the waste cannot be accepted, reject it in accordance with CMI's Rejection Policy in Section 6.0 of this WAP;
- Perform a WIP re-evaluation to determine if a new or revised WIP is necessary. This could involve sending the WIP to the generator for re-evaluation and re-certification. The new or revised WIP will be subjected to the Pre-Qualification process described in Section 2.0 of this WAP; and
- Maintain records of the above actions. Refer to Section 13.0 of this WAP for recordkeeping.

Note: CMI does not accept "unknown" wastes. All wastes received by CMI must be approved prior to shipment to the CMI facility. In the event that an unknown waste is left at the CMI facility during off hours, CMI will immediately contact the state's Waste Management Division. Following this consultation, CMI will attempt to identify the waste using Level I and/or Level II analyses for the purpose of accepting the waste or preparing the waste for shipment to an appropriate off-site facility.

7.2 Discrepancies Between the Waste and WIP

If a discrepancy between the waste received at the facility and its WIP is identified (e.g., discrepancy in pH, flammability, etc.), CMI will perform the following:

- Attempt to resolve the discrepancy by calling the generator and requesting additional information;

- Decide whether to accept or reject the waste despite the discrepancy. This involves a determination whether CMI can manage the waste on-site in a manner that is safe, effective and in accordance with the provisions of its permit;
- If a decision is made to reject the waste, follow the procedures in the Rejection Policy in Section 6.0 of this WAP;
- If the waste is not rejected, perform a Level II analysis to fully characterize the waste. Refer to Section 4.0 of this WAP for the procedures associated with a Level II analysis;
- Ask the generator to provide a corrective action plan that describes the reason for the discrepancy and actions to be taken to prevent re-occurrence;
- Perform a WIP re-evaluation to determine if a new or revised WIP is necessary. This could involve sending the WIP to the generator for re-evaluation and re-certification. The new or revised WIP will be subjected to the Pre-Qualification process described in Section 2.0 of this WAP; and
- Maintain records of the above actions. Refer to Section 13.0 of this WAP for recordkeeping.

8.0 Outbound Waste Screening Procedures

Containerized wastes that are compatible materials, supplemental fuels, used oil, or wastewater may be consolidated into bulk transportation vehicles at the CMI facility (see **Section D** of this permit). Prior to transferring waste into a bulk transport vehicle, the CMI Supervisor or Senior Waste Technician will review all applicable WIPs, test for compatibility (see method CMI-12); for supplemental fuels, CMI will also test for PCBs.

Waste that is bulked on-site for outbound shipments will be tracked using the Bulk Consolidation Tracking Sheet (see **Appendix D** of this section). Upon completion, this waste tracking form will be maintained with the facility copy of the outbound manifest as part of the facility operating record.

Bulk transport vehicles may be kept on-site for a maximum of 72 hours from the time/date when waste is first loaded onto the vehicle. All bulk transport vehicles will be located within secondary containment throughout loading (and/or unloading) operations.

9.0 Waste Sampling

Procedures for collecting representative samples are identified below. Collected samples will either be returned to their original container or consolidated with compatible materials prior to shipment off-site for proper disposal. Any “waste” material generated by sampling activities is either returned to the original waste container or CMI will utilize a new container.

9.1 Sampling Methods

The methods and equipment used for sampling waste vary with the form and consistency of the waste to be sampled. CMI will select the most appropriate representative sampling methods, techniques, devices, and containers from those included/described in either the EPA document “Test Methods for Evaluating Solid Wastes” (SW-846) or the “American Society for Testing and Materials” (ASTM) standards. A representative sample is defined as a sample exhibiting average properties of the whole waste.

CMI standard operating procedures designed to protect worker health and ensure worker safety while sampling the variety of waste types received by the CMI facility are included in **Appendix C** of this section.

9.2 Sample Tracking Documentation

All sampling will be performed by CMI personnel.

Samples collected for on-site Level I analysis will be documented utilizing the Level I QA/QC report (see **Appendix F**).

All Level II and III sampling will be documented utilizing the “Sample Record” log and the “Level II/Level III QA/QC Checklist” included in **Appendix G** of this section. Chain-of-custody forms (see **Appendix E** of this section) are used for tracking Level II and Level III samples sent for off-site laboratory analyses and testing.

9.3 Sampling Personnel

Sampling is performed in the waste receiving area (Cell A-1) by the CMI Supervisor or Senior Waste Technicians.

9.4 Sample Labels

Labels are affixed to each sample container prior to, or at the time of, sampling. At a minimum, the labels include the following information, if applicable:

- Generator name
- Common name of waste
- Name of sample collector
- Date of collection
- Unique container number
- WIP/waste stream number

A unique container number sticker, that matches the unique container number assigned to the original waste container, is also affixed to sample containers used for Level II and III analyses. Labels will be affixed after the sample has been removed and the container is resealed such that the container top and/or bung cannot be opened without disfiguring the label, thereby flagging those instances that other wastes may have been introduced.

10.0 Parameters and Rationale

The following table summarizes the analytical parameters and rationales used to determine the general and specific characteristics of a waste stream. ASTM and SW-846 are used as guidelines in developing the following analytical methods:

TABLE 3: Parameters and Rationale

Parameter	Method	Rationale for Selection
Physical Description	CMI-1	Used to determine the general characteristics of the waste stream. This facilitates subjective comparison of the sample waste with prior descriptions. CMI personnel check for color, general form, layering, and consistency.
pH Screen	CMI-2	Required of all water-bearing liquid, solid, and semi-solid waste streams to determine the corrosivity of the waste. The apparent pH of non-aqueous wastes will also be performed. Tight tolerance limits (e.g., +/- 2 pH unit change) will be established based on the storage requirements at the facility and other relevant considerations.
Water Reactivity	CMI-3	Used to determine whether the waste has a potential to react with water to generate heat, flammable gases, or other products. The test does not apply to wastes already in contact with excess water.
Reactive Sulfides Screen (Spot Test)	CMI-4	Used to indicate whether the waste produces hydrogen sulfide upon acidification below pH 2. It is not required if the pH of the waste is <6 or if the waste is not water-soluble.
Ignitability	CMI-5	Indicates the fire-producing potential of the waste and determines whether the waste is RCRA-ignitable. This test will be applied to all wastes liquids, solids, and sludges that are selected for analysis.
Reactive Cyanides Screen (Spot Test)	CMI-6	Indicates whether the waste produces hydrogen cyanide upon acidification below a pH of 2. It is not required for wastes with pH <6 or if the waste is not water-soluble.
Oxidizer Screen	CMI-7	A general qualitative test used to determine if a waste is an oxidizer. Oxidizers have the potential to react with a wide range of wastes and therefore often need to be segregated.
Specific Gravity	CMI-8	Used in conjunction with other test data to determine probable characteristics of materials and their conformance to the WIP.
Percent Suspended Solids	CMI-9	Used in assessing the feasibility of wastewater treatment.
Chlorine (Spot Test)	CMI-10	Indicates if the material is chlorinated. Information is used to check conformance to the WIP, as well as disposal options.
Polychlorinated Biphenyls Screen	CMI-11	Determines PCB content in order to verify WIP information and assess applicability under TSCA.

Parameter	Method	Rationale for Selection
Compatibility Testing	CMI-12	Prior to a waste being commingled with other wastes, it is tested to verify compatibility. Liquid or sludge wastes are combined to assess their compatibility. Solid waste compatibility is determined based on generator-provided information and records of bulk materials previously received and/or currently stored.
Total RCRA 8 Metals	CMI-13	Determines if the concentration of arsenic, barium, cadmium, chromium, lead, mercury, silver and selenium exceeds the limits in 40 CFR 261.24.
Total RCRA characteristic Volatile Organics	CMI-14	Determines if the waste is potentially listed (e.g., contains a volatile organic compound potentially used as a solvent) and if the concentration of any volatile organic compound exceeds the limits in 40 CFR 261.24.

11.0 Test Methods

The test methods used to confirm that waste received by CMI conforms to the corresponding WIP are described below.

CMI-1: Physical Description

The waste is sampled, visually inspected, and its physical appearance is recorded, the description is to include:

- color
- physical state (% solid, % sludge, % liquid)
- layers (single, bi-layered, multi-layered)
- presence of freestanding liquid using SW846-9095 as a guideline (Paint Filter Liquids Test)

If necessary, a Coli-wasa tube or thief/tube is to be used to check for layering and to determine the approximate percentage of each layer and approximate percentage of solid, sludge, and liquid.

CMI-2: pH Screen

The pH of a solid is measured by placing 20 grams of sample into a cup. 20 milliliters (ml) of deionized water is added and the mixture is stirred for 30 seconds. The pH of the slurry is then taken and recorded using SW846-9040 and SW846-9041 as guidelines. The pH of liquids and sludges is taken using SW846-9040 and SW846-9041 as guidelines.

CMI-3: Water Reactivity

The water reactivity of a liquid or solid is determined by adding approximately 3 mL of water to 0.1 mL of liquid or 0.1 gram of solid. The mixture is observed to detect heating (more than 15° C temperature rise) or turbulent gas evolution (more than 10% of the mixture volume). If the mixture reacts as described above, the test is considered positive. If the addition of water causes the material to be considered reactive under any definition of 40 CFR 261.23 or state regulations, the material is considered water-reactive.

CMI-4: Reactive Sulfides Screen (Spot Test)

2 to 4 drops of the material are placed on a spot plate. Then, a strip of lead-acetate paper moistened with 1 drop of water is placed over the spot plate cavity containing the waste. Next, 2 to 3 drops of 3M HCl is added. Black PbS forms in the paper after 0.5 to 1 minute if sulfide is present. The threshold limit of this method is around 4 PPM sulfide.

CMI-5: Ignitability

The ignitability screen is determined by placing the sample in a 125 to 250 mL cup. The cup is covered and allowed to stand for at least five minutes. After five minutes the cover is removed and a flame is placed near the opening of the cup. If a flash occurs, the ignitability screen is considered positive. If no flash is observed, a small amount is placed on the end of a spatula and heated over a flame. If the material ignites and sustains a flame for 10 seconds, the result is Negative B (per industry standard). If the sample does not sustain a flame for 10 seconds or ignites, the result is Negative C. A closed cup flash test will be used to determine flash point of any Negative B material.

CMI-6: Reactive Cyanides Screen (Spot Test)

Cyanide is determined by placing 2 to 4 drops or a small spatula tip of the sample on a spot plate. Two drops of water are then added to the waste. Next, one drop of chloramine-T solution followed by one drop of pyridine-barbituric acid solution is added to the waste. If the solution turns dark red or carmine after 10 to 30 seconds, this is a positive response.

The presence of cyanide can be detected above 60 ppb in aqueous samples (3 drop size) and 10 ppm in solid samples (1 gram size).

Reagents:

- Chloramine-T solution: 1 gram of Chloramine-T is dissolved in 100 ml of distilled water.
- Pyridine-barbituric acid: 1.5 g of barbituric acid is mixed with 5 mL of water and 7.5 mL of pyridine. The mixture is treated with 1.5 mL of concentrated HCl and diluted to 25 mL.

CMI-7: Oxidizer Screen

The method used is a qualitative examination for the presence of oxidizing materials in liquid, sludge, and solid samples.

■ Liquids and Sludges

The procedure for liquid and sludge waste consists of wetting a strip of KI-Starch paper in HCl. The wetted strip is then dipped into the sample. The color change is then noted. If the color turns light brown to dark purple or black, then the result is interpreted as positive, and the waste is managed as an oxidizer. The color is indicative of the type of oxidizer present.

■ Solids

The procedure requires that 2 mL of deionized water be added to 11 grams of sample. The mixture is then stirred for 30 seconds. A strip of KI-starch paper is wetted in HCl and then dipped into the slurry. The color change of the KI paper is then noted. If the color turns light brown to dark purple or black, then the result is interpreted as positive and the waste is managed as an oxidizer. The light brown color is indicative of nitric acid while the purple/black color results from the presence of peroxides.

CMI-8: Specific Gravity

The Specific Gravity of a liquid is determined by weighing 10 mL of the sample (at room temperature) and dividing this value by 10. The alternate method of using a hydrometer may be used if sufficient sample is present.

CMI-9: Percent Suspended Solids

Total suspended solids are determined by bringing the sample pH to approximately 3 using 10% sulfuric acid. A determination of the sample's pumpability is made without stirring. The sample must not gel or turn to sludge. The sample is centrifuged for five minutes and the percent solids are calculated.

CMI-10: Chlorine (Spot Test)

A small amount of the sample is placed in a test tube. Litmus paper is placed over the sample as heat is applied. A red coloration of the paper indicates the presence of chlorine. An additional test is done by placing a small amount of the material in a flame on a wire loop. A green color indicates the presence of chlorine.

CMI-11: Polychlorinated Biphenyls Screen

Method SW846-8082 is used to determine PCB content.

CMI-12: Compatibility Testing

Prior to a waste being commingled with other wastes, it is tested to verify compatibility. A representative sample of the waste is mixed with a representative sample of the wastes to be commingled. This is done under controlled conditions by personnel trained regarding chemical reactions.

Representative portions of the wastes to be commingled are mixed together at the same measured temperature to verify compatibility. For example, if a partially full container is to be consolidated into another partially full container, a representative sample is drawn from both containers, the samples are mixed. The mixture is then observed for the following:

- Evolution of gas characterized by bubbling or foaming
- Heat release evidenced by a temperature increase of more than 15 degrees over the measured temperature
- Polymerization of the mixture to an un-pumpable viscosity within 30 minutes
- Miscibility or the formation of layers
- Precipitate formation
- Emulsification

If any of these conditions are observed, the wastes are considered incompatible.

CMI-13: RCRA 8 Metals (totals with digestion)

- Liquids
Methods SW846-6010/7470
- Solids
Methods SW846-6010/7471

CMI-14: Volatile Organic Compounds (totals)

- Liquids
Volatile Organic Compounds – Method SW846-8260C
- Solids
Volatile Organic Compounds (with extraction) – Methods SW846-5035/8260

12.0 Quality Assurance and Quality Control

The following quality assurance/quality control (QA/QC or “quality”) information for this facility is being provided as required by 40 CFR 270.30(e) and in accordance with the following EPA guidance documents:

- Test Methods for Evaluating Solid Waste: Physical/Chemical Methods, SW-846, Third Edition, Final Update I, U.S. EPA, Office of Solid Waste, Washington, DC, July 1992, Chapter One, updated editions.
- Handbook for analytical Quality Control in Water and Wastewater laboratories, EPA 600/4-79-019, March 1979, US Environmental Protection Agency (USEPA), Environmental Monitoring and Support Laboratory (EMSL), Cincinnati, OH.

Quality protocols are applicable to both sampling and analytical techniques. This section does not provide specific QA/QC performance standards for individual sampling and analysis techniques. Such specifics are defined in specific operating procedures of the laboratories performing the tests. Portions of these policies have been summarized in the following sections.

12.1 Sampling Program

With some exceptions, all bulk and containerized waste shipments are sampled (see Section 4.0 of this WAP). Individual container samples that are related may be composited prior to analysis. Sampling procedures are described in Section 9.0 of this WAP. The selection of the sample collection device depends on the type of sample, the sample container, the sampling location and the nature and distribution of the waste components. In general, the methodologies used for specific materials correspond to those referenced in 40 CFR Part 261, Appendix I. The selection and use of the sampling device is supervised or performed by a person thoroughly familiar with the sampling requirements.

Sampling equipment is typically constructed of non-reactive materials such as glass, PVC plastic, aluminum, or stainless steel. Care is taken in the selection of the sampling device to prevent contamination of the sample and to ensure compatibility of materials. For example, glass bottles are not used to collect hydrofluoric acid wastes.

12.2 Analytical Program

CMI performs minor analyses on-site and subcontracts with independent, state certified or NELAC laboratories for all pre-qualification and Level II and III analyses. CMI and these laboratories have developed programs of analytical quality practices and procedures to ensure that precision and accuracy are maintained. These programs – which include use of control standards, duplicates, spikes, and blanks – are required. Non-company laboratories employed by the company demonstrate quality control practices that are comparable to CMI’s practices.

Good laboratory practices which encompass sampling, sample handling, housekeeping and safety are required by specific CMI procedures.

12.3 Conclusion

The aforementioned sampling and analytical quality practices help ensure the data obtained are precise and accurate for the waste stream being sampled. The analytical results are used by facility management to decide whether or not to accept a particular waste and, upon acceptance, to determine the appropriate method of treatment, storage, and disposal. Results are also important to ensure that wastes are managed properly by the facility and that incompatible wastes are not inadvertently combined. The quality of these results are as important as the results themselves. Thus, the quality of the analytical data, along with the thoroughness and care with which the sampling and analyses are performed and reported, provides an important basis for day-to-day operational decisions.

13.0 Recordkeeping and Reporting

CMI will report manifest discrepancies to EPA as specified at 40 CFR 264.72. In addition, CMI will subcontract with independent, state certified or NELAC laboratories to perform the Level II and III analyses, will maintain analytical data on-site, and will supply any analytical data to EPA when requested.

Issue to Consider

Note that some states have state-specific requirements for reporting.

The following records will be maintained in the facility's operating record:

- A record of Level I analyses as documented on the Level I QA/QC report (see Appendix F).
- A record and results of all Level II and Level III analysis will be maintained by CMI for each waste sampled/analyzed:
 - A copy of the chain of custody document (see **Appendix E** of this WAP)
 - Copies of all applicable analytical and test results and lab reports including the results of the Level I analysis
 - A copy of the original (incoming) manifest
 - A copy of the original WIP
 - Documentation of any discrepancies identified by the Level I, II or III analysis
 - If applicable, a copy of any written or correspondence with the generator related to resolving a WIP discrepancy and documentation of relevant conversations with the generator regarding same.

- If applicable, copies of any written correspondence with the generator and state Waste Management Division related to resolving a manifest discrepancy and documentation of relevant conversations with the generator or state Waste Management Division regarding same.
- If applicable, a copy of the revised WIP.
- The completed Level II/Level III QA/QC checklist (see **Appendix G** of this WAP)
- Records of analyses, corrective action plans and other actions taken under the Rejection Policy and Discrepancy Policy in this WAP.

In addition, CMI will produce bi-annual reports that summarize the frequency at which incoming shipments do not conform to their waste profiles. The report must indicate the steps taken by the facility to evaluate and resolve the discrepancies, including if new or revised WPSs were produced.

14.0 Corrective Action

CMI will subcontract with independent, state certified or NELAC laboratories for pre-qualification and Level II and III analyses. CMI and subcontracted laboratories have processes in place to ensure quality assurance and quality control (see Section 12.0 of this WAP). In addition, CMI and subcontracted laboratories have methods for correcting problems when they are identified. If problems/discrepancies are found, CMI may take a range of corrective actions, such as performing an audit of the laboratory, reviewing and revising applicable SOPs, and periodically evaluating subcontracted laboratories and entering into new subcontracts if CMI has a concern about the quality of work.

Appendices

The information in the appendices has been reduced to shorten the overall length of this WAP. This was done **solely** for purposes of presentation in this guidance document. The following appendices were removed:

- Appendix A: Example Waste Information Profile (WIP) Form
- Appendix B: Example Lab Pack Contents Form
- Appendix E: Example Chain of Custody Form

DRAFT

Appendix C: Standard Operating Procedures for Opening and Sampling Containers

Sampling of Containers

Coliwesas, tubes, drum thieves, and corers are examples of the devices used to sample containers. Samples are taken from locations displaced both vertically and horizontally throughout the waste. For liquids (or liquids with precipitated solids), the sample collector uses a Coliwasa or equivalent. The sampling device is inserted into the container from the top and is pushed down slowly until the bottom of the container is reached. The device is sealed to retain the contents. The contents of the sampling device are then transferred to a polyethylene or glass bottle that is labeled with waste identification information.

A corer or equivalent device is used to sample containers that are solid in nature. These containers are generally filled with dirt and sludges. Several areas from the container are sampled and composited into a jar in order to ensure a representative sample. The sample collector removes a sample that uniformly represents the waste composition of the container (i.e., all layers and phases are represented in the sample).

Sampling of Bulk Material

Bulk solids are sampled using a simple random sampling strategy. The bulk solids container, usually a roll-off box or a dump trailer, is divided into sections. A corer is used in each section to draw a sample from as deep as possible. On occasion, a shovel is used to access lower levels of a bulk container. The samples are composited together so that there is one sample that represents that particular bulk solids shipment.

Bulk liquids are sampled using a Coliwasa or similar device that can sample vertical anomalies. Each compartment of tanker truck is sampled. Compartment samples from the same generator and waste stream will not be composited prior to analysis.

Tank trucks without manways are sampled through a valve. The valve is flushed prior to the sample being drawn.

Debris

Debris is sampled as much as possible; however, not all wastes are amenable to sampling (e.g., universal waste batteries, CRTs, lamps or ballasts, lab packs, etc.). A container of debris often contains a wide variety of materials. For example, it may contain spill absorbent, Tyvek suits, rubber booties, gloves, and paper towels. It may be difficult to obtain a representative sample.

In virtually all situations, debris has one thing in common: non-hazardous materials are contaminated with very small to trace amounts of organic and inorganic hazardous constituents.

Frozen Waste

CMI will not sample waste that is frozen. The container will remain in the receiving area until the waste can be sampled and be stored on pallets.

Appendix F: Example Level I QA/QC Report

Date: _____

Time: _____

Initials: _____

Manifest Number: _____

Waste Information Profile (WIP) Number: _____

Number of Drums in Batch: _____

Profile Description of Waste: _____

Description of Waste (Observed): _____

Physical Characteristics/Screen Results: _____

% Liquids	
% Solids	
% Sludge	
Color	
Viscosity	
pH	
Flash Point	
% Fuel*	

Perform a visual inspection on each waste container, including covers and closure devices. Check for visible cracks, holes, gaps, or other open spaces into the interior of the container when the cover and closure devices are secured in the closed position. Examine the physical and structural integrity of the container (e.g., is it bulging, etc.):

Acceptable Unacceptable

If "Unacceptable", explain corrective actions taken:

*Waste containing less than 1% fuel cannot be managed under the state's "fuel-to-fuel" exemption (i.e., the waste does not contain a recoverable amount of fuel)

Appendix G: Level II/III QA/QC Checklist

Sample Date: _____
Generator: _____
Waste Stream (WIP) #: _____
Drum #: _____

If not the 500th container, justification for bypassing:

Results of Level II/III Analysis:

Documents to be included in Level II/III WAP file:

- Copy of Original Manifest _____
- Copy of Original WIP _____
- Copy of Level I QA/QC Report _____
- Original Chain of Custody _____
- Analytical Results _____

Additional documentation to be included in Level II/III WAP file (if applicable):

- Revised WIP _____
- Manifest Discrepancy Letter _____
- Correspondence with Generator/Customer _____

APPENDICES

APPENDIX A:

Hazardous Waste Identification

RCRA Section 3001 provides EPA with the authority to develop criteria for the identification of hazardous wastes. Under Section 1004 of RCRA, a hazardous waste is defined as a solid waste, or a combination of solid wastes which, because of its quantity, concentration, or physical, chemical, or infectious characteristics, may cause, or significantly contribute to an increase in mortality or an increase in serious irreversible or incapacitating reversible illness, or pose a substantial present or potential hazard to human health or the environment when improperly treated, stored, transported, disposed, or otherwise managed. The regulatory definition of a hazardous waste is found in 40 CFR §261.3, and is defined in two ways. First, solid wastes are hazardous wastes if EPA lists them as hazardous wastes; the lists of hazardous wastes are found in 40 CFR Part 261, Subpart D. EPA lists wastes based on criteria in 40 CFR §261.11. Wastes listed by EPA as hazardous contain hazardous constituents, are acutely hazardous, and/or exhibit the characteristics of ignitability, corrosivity, reactivity, or toxicity. Second, EPA identifies the characteristics of a hazardous waste based on criteria in 40 CFR §261.10. Accordingly, solid wastes are hazardous if they exhibit any of the following four characteristics of a hazardous waste: ignitability, corrosivity, reactivity, or toxicity (based on the results of the TCLP). Descriptions of these hazardous waste characteristics are found in 40 CFR Part 261, Subpart C. Exclusions to the regulatory definitions of solid waste and hazardous waste are found in 40 CFR §261.4.¹

Generators must conduct a hazardous waste determination according to the hierarchy specified in 40 CFR §262.11. Figure A-1 can be used to assist in making this hazardous waste determination, and can serve as a roadmap when reviewing the rest of Appendix A. Persons who generate a solid waste first must determine if the solid waste is excluded from the definition of hazardous waste under the provisions of 40 CFR §261.4. If the waste is not excluded, the generator must determine if it is listed as a hazardous waste; if the waste is not listed, or for the purposes of complying with the LDR requirements in 40 CFR Part 268, the generator must determine if the waste exhibits a characteristic of a hazardous waste, either by testing the waste or by utilizing acceptable knowledge about the process or materials used to generate the waste.

Listing Determination

Once the generator determines that a solid waste is not excluded, then he/she must determine if the waste meets one or more of the hazardous waste listing descriptions. The hazardous waste lists include wastes from nonspecific sources (termed “F-listed wastes,”); these wastes include spent solvents, electroplating wastes, and dioxin-bearing wastes. The hazardous waste listings also include wastes from specific sources (i.e., K-listed wastes),

¹ Note: EPA is in the process of issuing new rules on the definition of solid waste.

including wastes from wood preserving operations, organic and inorganic chemical production, pesticide formulation, explosives manufacturing, petroleum refining, iron and steel production, pharmaceutical manufacturing, and the lead, zinc, copper, and aluminum industries. The third group of hazardous waste listings include discarded unused commercial chemical products, off-specification products, and spill residues of such products (i.e., P- and U-listed wastes).

The hazardous waste listings also apply to certain mixtures of solid wastes. Under the “mixture rule” in 40 CFR §§261.3(a)(2)(iii) and (iv), mixtures of listed hazardous wastes and solid nonhazardous wastes are defined as hazardous wastes and retain their listing designations unless the hazardous waste in the mixture is listed solely based on a particular characteristic (that is, ignitability [I], corrosivity [C], reactivity [R], toxicity [E]) and the mixture no longer exhibits any of these hazardous waste characteristics. For example, a mixture of a spent methylene chloride formulation (listed as F002 because of its hazardous constituents) and used oil would be defined as a hazardous waste and be designated as F002 whether or not the mixture exhibited a hazardous waste characteristic. The mixture remains a hazardous waste unless the generator successfully petitions to delist the waste according to procedures outlined in 40 CFR §260.22.

The hazardous waste listings also apply to solid wastes derived from the treatment, storage, or disposal of a listed hazardous waste. The “derived-from rule” (40 CFR §261.3(c)(2)) defines residual solid wastes derived from the treatment, storage, or disposal of a listed hazardous waste as a hazardous waste and retain their listing designations unless the hazardous waste is listed solely based on a particular characteristic and the derived-from wastes no longer exhibits any of the hazardous waste characteristics. Examples of wastes defined as hazardous through the derived-from rule include ash resulting from the incineration of off-specification toluene (U220), and leachate resulting from the disposal of API separator sludge from the petroleum refining industry (K051) in a landfill. As with the mixture rule, a generator may petition EPA to delist a waste that is derived from a listed waste.

EPA also regulates mixtures of hazardous wastes and other materials that are not solid wastes. The “contained-in policy” states that materials containing a listed hazardous waste must be managed as hazardous wastes until the other material no longer contains the listed waste. This provision mainly applies to mixtures of listed hazardous wastes and environmental media (e.g., contaminated ground water, contaminated soil). An example of a waste regulated under the contained-in policy is soil contaminated with cyanides that has been excavated from under a tank that contains spent cyanide plating bath solutions from an electroplating operation (F007); this soil would be managed as F007.

Figure A-1 : Hazardous Waste Identification

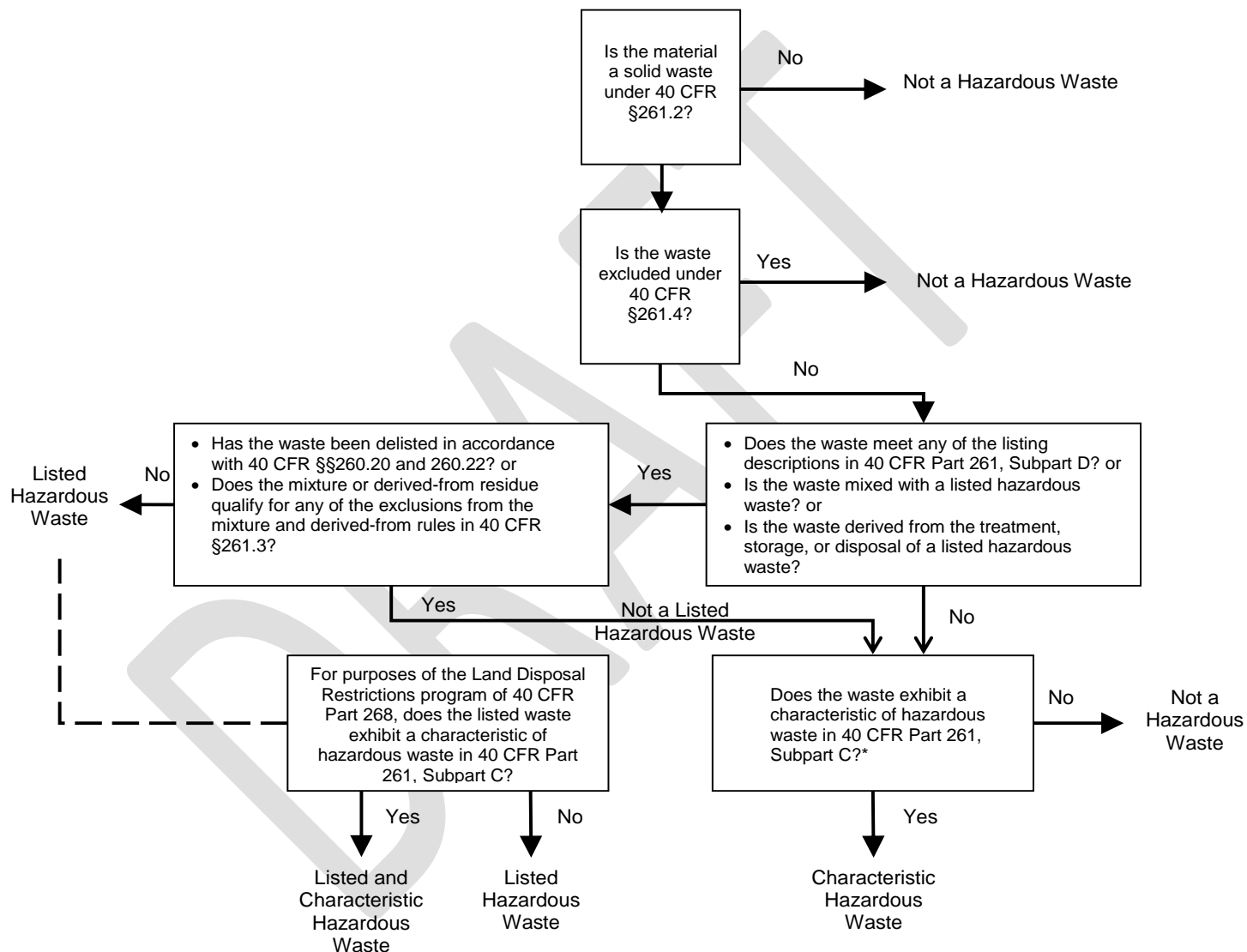

* Note exception for mixtures of characteristic wastes and mining/mineral processing wastes in 40 CFR §261.3(a)(2)(1)

Characteristics Determination

A solid waste that is not excluded from regulation and does not meet a listing description of a hazardous waste must be evaluated by the generator to determine if it exhibits a characteristic of a hazardous waste. A generator must evaluate such wastes to determine if they exhibit any of the four characteristics of a hazardous waste: ignitability, corrosivity, reactivity, and toxicity. This evaluation involves testing the waste or using acceptable knowledge of the process or materials used to produce the waste.

A waste is defined as **ignitable** according to a definition in 40 CFR §261.21. A waste is ignitable if it is a liquid and its flash point is less than 140° F (60° C). EPA Test Method 1010 (Pensky-Martens Closed Cup Method), EPA Test Method 1020 (Setaflash Closed Cup Method), or equivalent methods may be used to test for ignitability. A waste may also be defined as ignitable if it is an oxidizer or an ignitable compressed gas as defined in Department of Transportation (DOT) regulations in 40 CFR Part 173, or if it has the potential to ignite under standard temperature and pressure and when ignited burns so persistently and vigorously to create a hazard. Wastes that are ignitable are classified as EPA Hazardous Code D001. Examples of ignitable wastes are certain spent solvents (e.g., mineral spirits) and off-specification jet fuels.

The characteristic of **corrosivity** is described in 40 CFR §261.22. A waste is corrosive if it is aqueous (defined as amenable to pH measurement) and its pH is less than or equal to 2 or greater than or equal to 12.5. The tests used for this pH determination are EPA Test Method 9040 (pH Electrometric Measurement), EPA Test Method 9041 (pH Paper Method), or an equivalent method. A waste is also corrosive if it is a liquid and it corrodes steel at a rate of more than 0.25 inches per year under conditions specified in EPA Test Method 1110. Corrosive wastes are designated as EPA Hazardous Waste Code D002. Corrosive wastes include spent sulfuric acid and concentrated waste sodium hydroxide solutions that have not been neutralized.

A waste exhibits the characteristic of **reactivity** if it meets any of the criteria in 40 CFR §261.23. Wastes that exhibit the characteristic of reactivity are classified as EPA Hazardous Wastes Code D003.

The final characteristic of a hazardous waste is the **toxicity characteristic (TC)**. Generators who opt to test their waste for this characteristic must develop an extract of the waste according to the Toxicity Characteristic Leaching Procedure (TCLP - EPA Test Method 1311) found in Appendix II to 40 CFR Part 261. The extract is then subsequently analyzed using one or more of several methods listed below. The results of the analysis are compared to regulatory thresholds for 40 constituents in 40 CFR §261.24. Test methods in this step may include the following:

- EPA Test Methods 3010 and 6010 - for arsenic, barium, cadmium, chromium, lead, silver, and selenium
- EPA Test Method 7470 - mercury

- EPA Test Methods 3510 and 8080 - pesticides
- EPA Test Method 8260 - for volatile organics
- EPA Methods 3510 and 8270 - semivolatile organics
- EPA Test Method 8151 - herbicides.

If the extract from the TCLP procedure contains levels of any of the 40 constituents at or above regulatory thresholds, the waste is considered a hazardous waste. Wastes that exhibit the toxicity characteristic are classified as EPA Hazardous Waste Codes D004 through D043. Examples of wastes that may exhibit the characteristic of toxicity include petroleum wastes, wastes from organic chemical manufacturing, and pesticide and herbicide wastes.

Certain states may also have requirements for identifying hazardous wastes in addition to those described above. States authorized to implement the RCRA hazardous waste programs under Section 3006 of RCRA may promulgate regulations that are more stringent or broader in scope than federal regulations. For example, certain states have broadened the scope of the hazardous waste listings by specifically listing used oil as a hazardous waste. Some states also regulate hazardous wastes based on total (versus extract) waste analysis of individual hazardous constituents.

APPENDIX B: Regulatory Summary

This appendix presents a brief summary of some changes to the RCRA hazardous waste program that have occurred since the 1994 edition of this manual was issued. For more information concerning specific requirements, consult the Federal Registers cited herein and the Code of Federal Regulations. These changes include:

- Definition of solid waste final rule.
- Alternative requirements for laboratories owned by eligible academic entities.
- Conditional exemptions for military munitions.
- Conditional exemptions for low-level mixed waste storage, treatment, transportation, and disposal.
- Organic air emission standards for tanks, containers and surface impoundments (40 CFR Part 264 and 265, Subpart CC)
- Amendments to the Land Disposal Restrictions (LDR) regulations, including the Phase II - IV rules.
- Revisions and updates to the “Test Methods for Evaluating Solid Waste, Physical/ Chemical Methods” (SW-846) and issuance of the Methods Innovation Rule (MIR).

Definition of Solid Waste Final Rule and Re-proposal in 2011

In October 2003, EPA proposed a regulatory exclusion from the definition of solid waste which would streamline requirements for the recycling of hazardous secondary materials. After evaluating public comments and conducting independent analyses, the Agency published a supplemental proposal in March 2007.

On October 30, 2008, EPA published a final rule ([73 FR 64668](#)) establishing conditional exclusions for the following:

- Materials that are generated and legitimately reclaimed under the control of the generator (i.e., generated and reclaimed on-site, by the same company, or under “tolling” agreements);
- Materials that are generated and transferred to another company for legitimate reclamation under specific conditions; and
- Materials that EPA or an authorized state determines to be non-wastes through a case-by-case petition process.

The rule also contains a provision to determine which recycling activities are legitimate under the new exclusions and non-waste determinations. This provision ensures that only authentic recycling, and not treatment or disposal under the guise of recycling, receives the benefits of these streamlined regulations. In order to be legitimately recycled under these exclusions, the hazardous secondary material (1) must provide a useful contribution to the recycling process; and (2) the recycling must make a valuable new intermediate or final product. Two additional factors must also be considered: (1) whether the recycled material is managed as a valuable product; and (2) whether the recycled product contains toxic constituents at significantly greater levels than a non-recycled product made from virgin materials. These exclusions are not available for materials that are: (1) considered inherently waste-like; (2) used in a manner constituting disposal; or (3) burned for energy recovery.

On July 22, 2011, EPA issued a proposed rule ([76 FR 44094](#)) to modify certain aspects of the 2008 final rule. The 2011 proposal seeks to ensure that the recycling regulations, as implemented, encourage reclamation in a way that does not result in increased risk to human health and the environment from discarded hazardous secondary material. The proposed rule has not been finalized.

Alternative Requirements for Laboratories Owned by Eligible Academic Entities

On December 1, 2008, EPA added Subpart K to the generator standards at 40 CFR Part 262 ([73 FR 72912](#)). The new subpart applies to eligible academic entities, which are colleges and universities, and teaching hospitals and nonprofit research institutes that are either owned by or formally affiliated with a college or university. Subpart K is an alternative, tailored set of regulations that allow eligible academic entities the flexibility to make hazardous waste determinations in the laboratory; at an on-site central accumulation area; or at an on-site TSDF. The rule also provides incentives for eligible academic entities to clean-out old and expired chemicals that may pose unnecessary risk. Further, the rule requires eligible academic entities that opt into the rule to develop a Laboratory Management Plan (LMP), which is expected to result in safer laboratory practices and increased awareness of hazardous waste management. Eligible academic entities may choose not to opt into the new rule and remain subject to the pre-existing hazardous waste generator requirements.

Conditional Exemptions for Military Munitions

On February 12, 1997, EPA finalized regulations that clarify when conventional and chemical military munitions become a hazardous waste under RCRA ([62 FR 6621](#)). The rule establishes the regulatory definition of solid waste as it applies to three specific categories of military munitions: (1) unused munitions; (2) munitions being used for their intended purpose; and (3) used or fired munitions.

The rule conditionally exempts from the RCRA manifest and container marking requirements, waste non-chemical military munitions that are shipped from one military-owned or -operated TSDF to another in accordance with Department of Defense (DOD) military munitions shipping controls and from the RCRA Subtitle C storage regulations, waste non-chemical military munitions subject to the jurisdiction of the DOD Explosives Safety Board storage standards.

In addition, the rule identifies four specific circumstances under which unused munitions are considered to be a solid waste for regulatory purposes: (1) the unused munition is "abandoned by being disposed of, burned, or incinerated, or treated prior to disposal;" (2) the unused munition is removed from storage for purposes of disposal or treatment prior to disposal; (3) the unused munition is deteriorated, leaking, or damaged to the point that it can no longer be put back into serviceable condition, and cannot be reasonably recycled or used for other purposes; or (4) the munition has been determined by an authorized military official to be a solid waste.

Military munitions are not a solid waste for regulatory purposes (1) when a munition is being used for its intended purpose, which includes when a munition is being used for the training of military personnel; when a munition is being used for research, development, testing, and evaluation; and when a munition is destroyed during range clearance operations at active and inactive ranges; and (2) when a munition that has not been used or discharged, including components thereof, is repaired, reused, recycled, reclaimed, disassembled, reconfigured, or otherwise subjected to materials recovery activities.

This rule also specifies that used or fired munitions are solid waste when they are removed from their landing spot and then either (1) managed off-range (i.e., when transported off-range and stored, reclaimed, treated, or disposed of or (2) disposed of (i.e., buried or landfilled) on-range. In both cases, when the used or fired munition is a solid waste, it is potentially subject to regulation as a hazardous waste. Also, munitions that land off-range, and that are not promptly retrieved, are statutory solid waste.

Conditional Exemptions for Low-level Mixed Waste Storage, Treatment, Transportation, and Disposal

A "mixed waste" contains both radioactive and hazardous waste components. Mixed wastes are regulated under RCRA for the hazardous waste component and under the Atomic Energy Act (AEA) for the radioactive component. In general, the requirements of RCRA and AEA are consistent and compatible. The U.S. Nuclear Regulatory Commission (NRC) and the U.S. Department of Energy (DOE) regulate the radioactive portion of mixed waste under AEA authority, while EPA regulates the hazardous waste portion of mixed waste under RCRA authority.

Low-level mixed waste (LLMW) is waste that contains low-level radioactive waste (LLRW) and hazardous waste. LLRW is defined as any radioactive waste that is not high-level radioactive waste, spent nuclear fuel, or byproduct material. LLMW is generated at industrial

and hospital facilities and nuclear power plant facilities in a number of processes such as medical diagnostic testing and research, pharmaceutical and biotechnology development, pesticide research, and nuclear power plant operations.

On May 16, 2001, EPA finalized a rule ([66 FR 27217](#)) that provides increased flexibility to facilities for managing LLMW and naturally occurring and/or accelerator-produced radioactive material (NARM) containing hazardous waste. The rule exempts LLMW from RCRA storage and treatment requirements as long as the waste is generated under a single NRC license, meets the conditions specified, and is stored and treated in a tank or container. In addition, LLMW and NARM, which meet applicable treatment standards, may be conditionally exempt from the RCRA transportation and disposal requirements. This waste may be disposed of at LLRW disposal facilities, which are licensed by NRC. The rule also provides additional flexibility for manifesting these wastes when they are destined for disposal at such facilities. Although mixed waste meeting the applicable conditions is exempt from certain RCRA requirements, it must still be managed as radioactive waste according to NRC regulations. Note that DOE disposal facilities are not eligible to accept the exempt waste since they are not subject to NRC regulation.

Organic Air Emission Standards for Tanks, Containers and Surface Impoundments (Subpart CC)

Section 3004(n) of RCRA requires the development of standards to control air emissions from TSDFs as necessary to protect human health and the environment. EPA has promulgated a series of regulations to implement this requirement. These regulations control air emissions from certain process vents and equipment leaks (Parts 264 and 265, Subparts AA and BB), as well as air emissions from certain tanks, containers, and surface impoundments (Subpart CC). The Subpart AA and BB standards became effective on December 21, 1990, while the Subpart CC organic emission control standards became effective on December 6, 1996 ([61 FR 59932](#)).

Under Subpart CC, if a hazardous waste has an average volatile organic (VO) concentration less than 500 parts per million by weight (ppmw) at the point of waste origination or if the hazardous waste organic content has been reduced by a treatment process to the extent described in 40 CFR §§264.1082 or 265.1083 prior to placement in the waste management unit, the unit is exempt from the air emission controls required under the standards. Subpart CC applies to the containers and tanks of TSDFs and LQGs, as well as to TSDF surface impoundments:

- Containers. Subpart CC standards applicable to containers of hazardous wastes are specified in 40 CFR §§264.1086 and 265.1087. There are three levels of air emission controls for containers based on container size, organic contents, and whether the container is used in a waste stabilization process. Container Level 1 controls require that the hazardous waste be stored in an approved Department of Transportation (DOT) container, a container equipped with a cover and closure devices for each opening, or an open-top container with an organic vapor-suppressing barrier. Container Level 2

controls require that the hazardous waste be stored in an approved DOT container, a container that operates with no detectable organic emissions, or a demonstrated vapor-tight container. Container Level 3 controls require that the hazardous waste be stored in a container that is either vented directly to a control device or is located inside an enclosure that is vented through a closed-vent system to a control device. Design and operating criteria are specified in the rule for the enclosure, closed-vent system, and control device.

- Tanks. Subpart CC standards applicable to tanks containing hazardous wastes are specified in 40 CFR §§264.1084 and 265.1085. There are two levels of air emission controls for tanks based on the size of the tank, maximum organic vapor pressure of the waste, and whether the tank is used in a waste stabilization process. The owner or operator is responsible for determining whether Tank Level 1 or Tank Level 2 controls are applicable.
- Surface impoundments. Subpart CC standards applicable to surface impoundments containing hazardous wastes are found in 40 CFR §§264.1085 and 265.1086. To control air emissions from a surface impoundment managing a hazardous waste with a VO concentration >500 ppmw, an owner or operator must install and operate either a floating membrane cover or a cover that is vented through a closed-vent system to a control device.

Land Disposal Restrictions (LDR) Regulations (Part 268)

The 1984 Hazardous and Solid Waste Amendments (HSWA) to RCRA prohibit the land disposal of specific groups of hazardous waste, unless it has been determined that there will be no migration of the hazardous constituents for as long as the waste remains hazardous. The amendments also required EPA to establish treatment standards for all listed and characteristic wastes, expressed as concentration levels or methods of treatment that will reduce their toxicity and make them safe for land disposal. These treatment standards are found in Part 268, Subpart D. LDRs apply to all generators (except conditionally exempt small quantity generators) and transporters of hazardous waste, as well as to owners and operators of treatment, storage, and disposal facilities (TSDFs).

Generators must determine whether their waste is subject to the LDRs for each hazardous waste at the point of generation, or alternatively, ask the treatment facility to do so. HSWA requires that both listed and characteristic determinations be made for each waste as specified. The generator can make this determination using acceptable knowledge, by conducting a total waste analysis, or by testing the waste extract. If a generator determines the waste is prohibited from land disposal and elects to treat the waste on site (in accumulation tanks, containers, or containment buildings regulated under 40 CFR §262.34), a written waste analysis plan (WAP) must be developed to describe the procedures the generator will carry out to comply with the treatment standards and the plan must be kept on site in the generator's records. Although no specific criteria are established for generators developing a WAP in accordance with 40 CFR §268.7(a)(5), the plan should be written in accordance with the procedures prescribed in this manual (i.e., describe the physical and

chemical analysis that will be conducted on a representative sample of the waste(s) being treated, and specifically describe the frequency of testing). WAPs are not required from generators who are treating for purposes other than meeting the LDR treatment standards.

Treatment/storage facilities are responsible for including in their WAP (40 CFR §§264.13/265.13) procedures used to corroborate that correct treatment standards have been selected for incoming wastes and provisions for testing the waste to verify that it meets the LDR treatment standard(s). These facilities will receive the generators' certification and any available waste analysis data provided by the generator (40 CFR §§264.73, 265.73). However, upon subsequent management of the waste, the treatment/storage facility, like the generator who ships directly to a disposal facility, must certify to the disposal facility that the waste meets the applicable treatment standards.

The disposal facility receives certifications that the waste meets the LDR treatment standards from generators and treatment/storage facilities. The results of waste analysis or other information on the waste's properties should also be provided by generators or treaters of the waste. The disposal facility must conduct sampling and analysis of incoming wastes to verify that wastes meet the relevant treatment standards for the specific waste. The procedures for waste sampling and analysis, including the frequency of testing, must be documented in the facility's WAP.

Since the 1994 edition of this manual was issued, there have been many amendments to the LDR program. Some key amendments include the following:

- EPA finalized the Phase II Rule on September 19, 1994 ([59 FR 47982](#)). This final rule consolidated the existing treatment standards into 40 CFR §268.40, created the Universal Treatment Standards (UTS), and promulgated treatment standards for toxicity characteristic organic wastes, and the coke by-products and chlorotoluenes listed wastes.
- EPA finalized the Phase III Rule and subsequent partial rescission on April 8, 1996 ([61 FR 15566](#) and [15660](#)). These final rules modified treatment standards for reactive wastes and decharacterized wastewaters, and promulgated new treatment standards for the carbamate and spent aluminum potliner listed wastes. Even though Phase III promulgated treatment standards for these newly identified carbamate wastes, in the case, *Dithiocarbamate Task Force v. EPA*, the D.C. Circuit Court of Appeals vacated several carbamate hazardous waste listings, thus nullifying their corresponding LDR treatment standards ([62 FR 32974](#); [June 17, 1997](#)).
- EPA finalized the first half of the Phase IV Rule on May 12, 1997 ([62 FR 25998](#)). This final rule promulgated treatment standards for the wood preserving listed wastes and streamlined the LDR notification requirements. EPA promulgated part two of the Phase IV Rule on May 26, 1998 ([63 FR 28556](#)). This rule finalized treatment standards for several metal-containing listed wastes and certain newly identified mineral processing listed wastes, and revised the universal treatment standards for twelve metal constituents. The rule also created a new treatability group, soil, and established soil specific alternative treatment standards.

Further discussion of LDRs is available in:

- US EPA, Land Disposal Restrictions: Summary of Requirements, [EPA530-R-01-007](#), Revised 2001.
- US EPA, Introduction to Land Disposal Restrictions (40 CFR Part 268), [EPA530-K-05-013](#), September 2005.

Test Methods for Evaluating Solid Waste (SW-846) and The Methods Innovation Rule (MIR)

The EPA publication SW-846, entitled *Test Methods for Evaluating Solid Waste, Physical/Chemical Methods*, is the official compendium of analytical and sampling methods that have been evaluated and approved for use in complying with the RCRA regulations. SW-846 functions primarily as a guidance document setting forth acceptable, although not required, methods for the regulated and regulatory communities to use in responding to RCRA-related sampling and analysis requirements.

SW-846 was first issued by EPA in 1980 and was originally intended to serve as a guidance manual of generally appropriate and reliable analytical methods for testing and monitoring waste. Some of the regulations required the use of SW-846 methods in general, and therefore all of the publication had to be incorporated by reference at 40 CFR §260.11(a). In the late 1990s, EPA determined that some of the required uses of SW-846 are not necessary and that members of the regulated community may use other reliable methods to comply with the hazardous waste regulations.

In 1998, EPA proposed to remove certain required uses of SW-846 methods, and to allow more flexibility in test method selection and EPA proposed to amend the hazardous and nonhazardous solid waste regulations for testing and monitoring activities from the RCRA regulations. This amendment has come to be known as, “The Methods Innovation Rule” (MIR), which includes the following revisions (see [70 FR 34537, June 14, 2005](#)):

- Certain SW-846 testing regulations will allow the use of other practical test methods, so long as they fall within EPA’s parameter to protect human health and the environment. Some required uses of SW-846 methods, referred to as method-defined parameters remain in the regulations because they involve determinations (e.g., TCLP), which can only be the method specified.
- Finalizes proposed revisions to Update IIIB to the Third Edition of SW-846;
- Removes requirements to use Chapter Nine, “Sampling Plan” in certain circumstances;

- Amends Sections 7.3.3 and 7.3.4 of SW-846 Chapter Seven to withdraw the:
 - Cyanide and sulfide reactivity guidance;
 - Required uses of reactive cyanide and sulfide methods; and
 - Threshold levels from conditional delistings.

Advances in analytical instrumentation and techniques are continually reviewed by EPA and incorporated into periodic updates to SW-846 to support changes in the regulatory program and to improve method performance and cost effectiveness. To date, EPA has finalized Updates I, II, IIA, IIB, III, IIIA, IIIB, IVA and IVB to the SW-846 manual. Today, the updated and fully integrated manual contains multiple volumes of approximately 3500 pages. For additional information, including the latest method updates, visit the [SW-846 homepage](#).

DRAFT

APPENDIX C: Regulatory Citations for Conducting Waste Analysis

Regulatory Citations Specific to Waste Analysis Plans, Waste Analysis, and Waste Determination

This appendix presents a table identifying many, but not necessarily all, of the federal hazardous waste analysis requirements found in 40 CFR Parts 262 through 266, 268 and 270. The table indicates if the requirements apply to generators, permitted TSDFs, and/or interim-status TSDFs. The table includes links to these requirements on the web (CTRL + Click to follow link). Go to www.gpo.gov/fdsys for the full regulatory text. Following the table is a brief regulatory discussion of remediation waste and wastewaters.

The information in this appendix is provided solely as guidance for permit applicants, permit writers, and others. It is not intended for compliance or enforcement purposes. It is current as of 2012. Refer to your state's regulations to learn the up-to-date requirements that apply to you, as they may be more stringent and/or broader in scope than the federal program.

Table of Waste Analysis and WAP Requirements

Regulation	Generator	Permitted TSDF ^a	Interim-Status TSDF ^a
Generators (Part 262)			
Generator hazardous waste determinations	262.11		
University Laboratories XL Project	Subpart J of Part 262		
Subpart K—alternative requirements for hazardous waste determination and accumulation of unwanted material for laboratories owned by eligible academic entities	Subpart K of Part 262		
TSDFs (Parts 264 and 265)			
Hazardous waste analyses and waste analysis plans		264.13	265.13
Manifest system and operating record requirements		Subpart E of Part 264	Subpart E of Part 265
Closure of hazardous waste management unit or facility		264.113	265.113
Containers: special requirements for incompatible wastes		264.177	
Tanks: waste analysis and trial tests			265.200
Surface impoundments: waste analysis and trial tests			265.225
Waste piles: waste analysis			265.252

Regulation	Generator	Permitted TSDF ^a	Interim-Status TSDF ^a
Land treatment: waste analysis			265.273
Landfills: design and operation			265.301
Incinerators: waste analysis		264.341	265.341
Thermal treatment: waste analysis and trial tests			265.375
Chemical, physical and biological treatment: waste analysis and trial tests			265.402
Test methods and procedures for organic air emissions for process vents under Subpart AA	265.1034^b	264.1034	265.1034
Test methods and procedures for organic air emissions for equipment leaks under Subpart BB	265.1063^b	264.1063	265.1063
Waste determination procedures for organic air emissions from containers, tanks and surface impoundments under Subpart CC	265.1084^b	264.1083	265.1084
Boilers and Industrial Furnaces (Part 266)			
Boilers and industrial furnaces (BIFs): analysis of Part 261 Appendix VIII constituents for trial burn, etc.		266.102(b)	
Boilers and industrial furnaces (BIFs): stack emissions testing			266.103(c)(3)(ii)(B)
Methods manual for compliance with the BIF regulations		Appendix IX to Part 266	
Land Disposal Restrictions (Part 268)			
Analysis of wastes treated in surface impoundments			268.4
Analysis of wastes to be placed in landfills under Land Disposal Restrictions (LDR) petition			268.6
LDR requirements for generators, treaters and disposers to determine if their waste meets LDR treatment standards and to comply with related requirements		268.7(a), (b), and (c)	
LDR requirement for generators and TSDFs to test their wastes that are subject to a variance from a treatment standard		268.44	
Permitting Requirements (Part 270)			
Requirements to include waste analysis data and WAP in Part B permit application		270.14	
Incinerators: submittal of waste analysis data in Part B permit application		270.19	
Land treatment facilities: submittal of waste data in Part B permit application		270.20	
Incinerators: submittal of waste analysis data for trial burn		270.62	
Boilers and industrial furnaces: submittal of waste analysis data for trial burn		270.66	
Requirement for submittal of WAP by applicant of standardized permit for tanks and containers		270.275	

^a. TSDFs that generate hazardous waste are subject to the Part 262 generator standards (i.e., the "Generator" column in this table), as applicable.

^b. Large quantity generators are subject to the organic air emission standards at Subparts AA, BB, and CC of Part 265. Small quantity generators are not subject.

Other Regulatory Resources

Remediation Waste Identification

Many facilities will generate some type of remediation waste whether it is from incidental spills or from historical contamination. These wastes also need to be properly identified. Note that not all remediation wastes are subject to the RCRA Subtitle C hazardous waste requirements. As with any other solid waste, remediation wastes are subject to RCRA Subtitle C only if they are listed hazardous wastes, derived from a listed waste or identified hazardous waste. Environmental media are likewise subject to RCRA Subtitle C only if they contain listed hazardous waste, are derived from listed a listed waste or exhibit a characteristic of hazardous waste. These distinctions are discussed more completely in the guidance document [Management of Remediation Waste Under RCRA \(EPA530-F-98-026\)](#).

Wastewater Treatment Sludge Disposal

Almost every business or industry generates wastewater. If you generate an industrial wastewater, you may have to treat it before you can sewer it, discharge it into a stream or lake, or do something else with it. If you treat your wastewater, you may generate industrial wastewater treatment sludge. Wastewater treatment sludge is a solid waste and may also be a hazardous waste. Both require special management.

What is Wastewater Treatment Sludge?

The treatment of wastewaters frequently produces sludge. 40 CFR §260.10 defines wastewater treatment sludge as “any solid, semi-solid or liquid waste generated from a municipal, commercial, or industrial waste water treatment plant, water supply treatment plant, or air pollution control facility exclusive of the treated effluent from a wastewater treatment plant.”

Any sludge that is not domestic wastewater sludge is industrial sludge. This includes wastewater sludge from manufacturing or processing of raw materials, intermediate products, final products or other activities that include pollutants from non-domestic wastewater sources.

When Is Wastewater Treatment Sludge NOT a Hazardous Waste?

The **treatment** of wastewaters is generally exempt from hazardous waste regulation if done in a “Waste Water Treatment Unit” (WWTU) that meets the definition noted below.

Sludges, while they remain in an active WWTU, are not normally regulated as hazardous wastes. If the sludges in the WWTU go directly from that unit into a municipal sewer, and travel through that sewer to a “Publicly Owned Treatment Works” (POTW) after mixing with sanitary wastes as outlined below, the sludges are not subject to a hazardous waste

determination or otherwise regulated as hazardous waste unless they leak from the sewer prior to reaching the POTW.

Prior to entering the sewer system and meeting the criteria outlined below, the waste may be a solid and a hazardous waste subject to hazardous waste regulation during generation, storage, and treatment.

Once the waste has been discharged to the POTW, it is subject to Clean Water Act (CWA) and local restrictions. However, sludges generated from a POTW are solid and may be hazardous wastes. Note that the CWA may prohibit discharges of certain chemicals and wastes into a sewer system.

In summary, mixtures of sanitary wastes and other wastes (including hazardous industrial wastes) that pass through a municipal sewer system to a POTW may be excluded from hazardous waste regulations. The exclusion applies to a waste at the point where it first mixes with sanitary wastes in the municipal sewer system if this mixing occurs prior to reaching the POTW property boundary. This exclusion does not apply to any waste directly transported to the POTW by truck or rail shipments. This exclusion also presumes that the mixture actually arrives at the POTW. In addition, the exemption is lost for any mixture in the municipal sewer system that leaks from the system prior to arrival at the POTW.

When is Wastewater Treatment Sludge a Hazardous Waste?

If industrial or processing wastes are removed from the wastewater treatment unit prior to being discharged into the sewer or do not pass through a municipal sewer to a POTW, they are subject to a hazardous waste determination. Unless they have mixed with sanitary wastes in a municipal sewer, these sludges may be listed or characteristic hazardous wastes. If the wastewaters going into the WWTU are listed hazardous waste, the sludges from the WWTU will also be listed hazardous waste.

How Do You Manage a Hazardous Waste Sludge?

Several hazardous waste codes may apply to your sludge depending on your industrial processes. Depending on what hazardous waste codes would apply to your sludge, and its physical and chemical nature, you might have a number of management options. You might have to dispose of it as hazardous waste at a permitted hazardous waste landfill or incinerator. You might be able to manage it under different requirements through some form of reclamation or recycling. You may be able to reuse the material if the use is legitimate according to U.S. Environmental Protection Agency or authorized State regulatory authority (i.e., the proposed use is not a subterfuge to avoid regulation of the material as hazardous waste).

Definitions

Publicly Owned Treatment Works (POTW) means a treatment works, as defined by Section 212 of the *Clean Water Act (CWA)* that is owned by the state or municipality. This

definition includes any devices and systems used in the storage, treatment, recycling, and reclamation of municipal sewage or industrial wastes of a liquid nature. It also includes sewers, pipes, and other conveyances only if they convey wastewater to a POTW treatment plant [40 CFR §403.3]. Privately-owned treatment works, Federally-owned treatment works, and other treatment plants not owned by municipalities are not considered POTWs.

Tank means a stationary device, designed to contain an accumulation of hazardous waste, which is constructed primarily of non-earthen materials (e.g., wood, concrete, steel, plastic) which provide structural support. (From 40 CFR §260.10).

Tank system means a hazardous waste storage or treatment tank and its associated ancillary equipment and containment system. (From 40 CFR §260.10).

Wastewater treatment unit means a device which:

- (1) Is part of a wastewater treatment facility that is subject to regulation under either section 402 or 307(b) of the *CWA*; and
- (2) Receives and treats or stores an influent wastewater that is a hazardous waste as defined in §261.3 of this chapter, or that generates and accumulates a wastewater treatment sludge that is a hazardous waste as defined in Sec. 261.3 of this chapter, or treats or stores a wastewater treatment sludge which is a hazardous waste as defined in Sec. 261.3 of this Chapter; and
- (3) Meets the definition of tank or tank system §260.10 of this chapter. (From 40 CFR §260.10)

Wastewater is not defined under the federal and state hazardous waste regulations, but EPA assumes that wastewaters “are substantially water with contaminants amounting to a few percent at most.” (See RCRA Online #[11020](#) and #[14472](#)).

APPENDIX D: Overview of Major Hazardous Waste Management Units

Containers

Containers are portable devices used to treat, store, transport, and handle waste materials. They include metal drums and pails, polyfiber bags, plastic drums and carboys, or durable fiberboard paper drums or pails. They do not include tanks, which are regulated separately, as discussed below. Metal and plastic drums and pails are the most commonly used containers; however, durable fiber drums (used most often to store and transport solids designated for incineration) and drums constructed of other materials are also used. Before selecting a container for storage or treatment of the waste, you should identify its physical and chemical characteristics to ensure that it is compatible with the waste. The selection of waste analysis parameters will be dependent upon the specific characteristics of the wastes you manage and the construction materials of the container used at your facility. You should consider performing laboratory analysis on a sample of your wastes for parameters such as flash point, pH, reactivity, and moisture content.

Tanks

Tanks are stationary devices constructed primarily of non-earthen materials designed to contain an accumulation of hazardous waste(s). They do not have to be totally enclosed and they are generally distinguished from surface impoundments because they are self-supporting (i.e., they do not need external support materials, such as earth). They are generally constructed of metal, fiberglass, or rugged plastics.

Surface Impoundments

Surface impoundments are natural depressions, man-made excavations, or diked areas, formed primarily of earthen materials, used to contain an accumulation of liquids or wastes containing free liquids. Examples of surface impoundments are ponds, lagoons, and holding, storage, settling and aeration pits. Surface impoundments can be used as treatment, storage, or disposal units.

Although surface impoundments are constructed primarily of earthen materials, they often can have components made of synthetic materials, such as liners and leak detection systems. Synthetic materials that are most often used in the construction of liners include high-density polyethylene, chlorinated polyethylene, and polyvinyl chloride. Leak detection and leachate collection systems can be constructed from a number of geosynthetic textile materials, including polyethylene, polypropylene, and polyester. Surface impoundments

may be equipped with a variety of high-strength polymer plastic piping (e.g., polyvinyl chloride) to aid in the removal of liquids that have accumulated in leachate collection systems, a component of the leak detection system.

Landfills

Landfills are disposal units where hazardous wastes are placed in or directly on land. In the RCRA regulations, waste piles, surface impoundments, land treatment units, underground injection wells, salt dome formations, mines, or caves are not regulated as landfills. Landfills are usually man-made excavations, but their designs invariably include the use of synthetic materials for liners, caps, and leachate collection systems. These synthetic materials may include high-density polyethylene, chlorinated and sulfurated polyethylene, polyvinyl chloride (PVC), and other geosynthetic textiles.

Containment Buildings

Containment buildings are enclosed structures used to store or treat hazardous waste. They must be completely enclosed to prevent exposure to precipitation and wind, and be constructed of man-made materials of sufficient strength and thickness to support themselves, the waste contents, and any personnel and heavy equipment that operate within the unit.

Wastes managed in containment buildings cannot be in liquid form (i.e., flow under their own weight to fill the vessel in which they are placed, or be readily pumpable). However, containment buildings can be used to manage hazardous wastes containing free liquids, but must include a primary barrier to prevent migration of hazardous constituents into the barrier and a liquid collection and removal system that will minimize the accumulation of liquid on the primary barrier; and be equipped with secondary containment including (1) a secondary barrier and (2) a leak detection, collection, and removal system. Containment buildings must have a primary barrier designed and constructed of materials to prevent hazardous wastes from being accidentally or deliberately placed on the land beneath or outside the unit. They must also have controls to prevent fugitive dust emissions and the tracking of materials from the unit by personnel or equipment. Under certain conditions, containment buildings may serve as secondary containment for tanks placed within the containment building.

As with tanks and containers, generators may accumulate and treat their hazardous wastes within these containment buildings without obtaining a RCRA Subtitle C permit. Generators treating hazardous wastes in order to comply with the applicable land disposal restrictions treatment standards must develop and follow a written waste analysis plan.

Waste Piles

Waste piles are areas used for non-containerized storage or treatment of solid, non-flowing wastes on the land. Waste piles are normally underlain by liners constructed of concrete or other materials, which act as barriers to prevent direct contact of the waste with the soil below the unit. Waste piles that are protected from wind, precipitation, and surface water run-on, and that are not containment buildings, are subject to reduced regulations. Waste piles and their associated liners and leak detection systems can be constructed of synthetic materials, including high-density polyethylene and PVC for liners, and a number of different geosynthetic textiles (e.g., polyester polypropylene) for leak detection apparatus. Waste piles also use a variety of high-strength polymer plastic pipes for the removal of leachate and other liquids that have accumulated in leachate collection systems; these are often made of polyvinyl chloride. Because of the impact of the Land Disposal Restriction program, most hazardous wastes cannot be placed on a waste pile until they meet the applicable LDR treatment standards in 40 CFR Part 268, Subpart D.

Land Treatment Units

Land treatment units are units where hazardous waste is applied or incorporated into the soil surface. Land treatment units are typically units consisting of natural soils where natural biological and chemical degradation and attenuation processes immobilize, transform, or degrade hazardous constituents over time. These soils are normally prepared in a manner that maximizes these reactions in the upper layers of soil (the treatment zone), and minimizes processes that might inhibit beneficial reactions or result in the release of hazardous constituents (such as surface water run-off). Because of the impact of the LDR program, most hazardous wastes cannot be placed in a land treatment unit until they meet the applicable LDR treatment standards, unless a no migration exemption has been granted under 40 CFR §268.6

Miscellaneous (Part 264, Subpart X) Units

Miscellaneous units (e.g., salt domes, burn pans, open burning or detonation grounds) include a variety of types of units that are not covered by any other permit standards under RCRA. A miscellaneous unit is a hazardous waste management unit where hazardous waste is treated, stored, or disposed of and that is not a container, tank, surface impoundment, pile, land treatment unit, landfill incinerator, boiler, industrial furnace, underground injection well with appropriate technical standards under 40 CFR Part 264, containment building, corrective action management unit, or a unit eligible for a research, development, and demonstration permit under 40 CFR §270.65. Under 40 CFR §270.32, EPA or state regulators has authority to include terms and conditions that it determines necessary to protect human health and the environment. This is referred to EPA omnibus authority.

Hazardous Waste Combustors

Hazardous waste combustors (HWCs) are differentiated based on how the CAA defines source categories and how the combustion unit is designed and operated. Certain types of boilers and industrial furnaces (BIFs) and incinerators that burn hazardous waste are examples of hazardous waste combustors. Hazardous waste combustors are subject to applicable regulatory requirements pursuant to both the RCRA Subtitle C program and the Clean Air Act (CAA) National Emission Standards for Hazardous Air Pollutants (NESHAP) program.

Prior to the adoption of the CAA Hazardous Waste Combustor (or HWC) NESHAP standards, emissions from RCRA hazardous waste combustion units were regulated according to 40 CFR Parts 264 and 265 (for incinerators) and 40 CFR Part 266 (for BIFs). Thus, for BIFs and incinerators, the RCRA emission standards/limitations and related operating requirements resided in the RCRA permit or interim status regulations, and all waste analysis requirements to comply with the requirements were located in the waste analysis plan (WAP). Between 1999 and 2005, EPA established new CAA HWC NESHAP emission standards, testing and operating requirements for incinerators, cement kilns, lightweight aggregate kilns, boilers, and hydrochloric acid (HCl) production furnaces burning hazardous waste. The CAA HWC NESHAP is codified in 40 CFR Part 63, subpart EEE.

In order to avoid (to the extent practicable) having duplicative emission standards and operating requirements in the RCRA permit and the CAA notification of compliance and Title V permit, EPA finalized a regulatory approach allowing a facility to modify its RCRA permit to remove most or all emission standards and emission related operating requirements that are covered by the CAA HWC NESHAP once the source demonstrated compliance with 40 CFR Part 63, subpart EEE. Under this approach, the CAA HWC NESHAP emission standards and emission related operating requirements reside in the CAA notification of compliance and Title V permit, while the other RCRA requirements associated with the combustion unit and the facility remain in the RCRA permit. Examples of requirements that continue to be part of the RCRA permit for HWCs include general facility standards, WAPs, closure plans, contingency plans, financial assurance, corrective action, and RCRA omnibus provisions.

The table below crosswalks some of the requirements for CAA feedstream analysis plans (FAPs) at 40 CFR §63.1209(c) to similar requirements for RCRA WAPs and waste analyses at 40 CFR §264.13 and elsewhere in RCRA. It also identifies sections of this manual that may provide helpful guidance.

Crosswalk of FAP-WAP Requirements to Sections of this Manual

CAA FAP Requirements at 40 CFR §63.1209(c)	RCRA WAP Requirements at 40 CFR §264.13 (and Related Requirements)	Sections of this Manual Relevant to FAPs
(c) <i>Analysis of feedstreams</i> —(1) <i>General</i> . Prior to feeding the material, you must obtain an analysis of each feedstream that is sufficient to document compliance with the applicable feedrate limits provided by this section.	40 CFR §264.13 (a)(1) Before an owner or operator treats, stores, or disposes of any hazardous wastes, or nonhazardous wastes if applicable under § 264.113(d), he must obtain a detailed chemical and physical analysis of a representative sample of the wastes. At a minimum, the analysis must contain all the information which must be known to treat, store, or dispose of the waste in accordance with this part and part 268 of this chapter.	1.1.2 TSDF Waste Analysis Requirements 1.2.1 Sampling and Analysis for TSDFs
(2) <i>Feedstream analysis plan</i> . You must develop and implement a feedstream analysis plan and record it in the operating record. The plan must specify at a minimum:	40 CFR §264.13 (b) The owner or operator must develop and follow a written waste analysis plan which describes the procedures which he will carry out to comply with paragraph (a) of this section. He must keep this plan at the facility. At a minimum, the plan must specify:	1.1.2 TSDF Waste Analysis Requirements Part Two: Documenting and Conducting Waste Analysis
(i) The parameters for which you will analyze each feedstream to ensure compliance with the operating parameter limits of this section;	40 CFR §264.13 (b)(1) The parameters for which each hazardous waste, or non-hazardous waste if applicable under § 264.113(d), will be analyzed and the rationale for the selection of these parameters (i.e., how analysis for these parameters will provide sufficient information on the waste's properties to comply with paragraph (a) of this section);	2.4 Analysis Parameters
(ii) Whether you will obtain the analysis by performing sampling and analysis or by other methods, such as using analytical information obtained from others or using other published or documented data or information;	40 CFR §264.13 (a)(2) The analysis may include data developed under part 261 of this chapter, and existing published or documented data on the hazardous waste or on hazardous waste generated from similar processes.	1.2 How Can You Meet the Waste Analysis Requirements for Your Facility? 1.2.2 Acceptable Knowledge and TSDFs
(iii) How you will use the analysis to document compliance with applicable feedrate limits (e.g., if you blend hazardous wastes and obtain analyses of the wastes prior to blending but not of the blended, as-fired, waste, the plan must describe how you will determine the pertinent parameters of the blended waste);	See 40 CFR 264.13 (b)(1) above.	2.4 Analysis Parameters
(iv) The test methods which you will use to obtain the analyses;	40 CFR §264.13 (b)(2) The test methods which will be used to test for these parameters; 40 CFR §264.13 (b) (3) The sampling method which will be used to obtain a representative sample of the waste to be analyzed. 40 CFR §264.13 (b) (4) The frequency with which the initial analysis of the waste will be reviewed or repeated to ensure that the analysis is accurate and up to date	2.4 Analysis Parameters 2.5 Selecting Sampling Procedures 2.6 Selecting a Laboratory and Laboratory Analytical Methods 2.7 Quantifying Data Uncertainty 2.8 Determining Re-Evaluation Frequencies
(3) <i>Review and approval of analysis plan</i> . You must submit the feedstream analysis plan to the Administrator for review and approval, if requested.	40 CFR 270.14 Contents of Part B [Permit Application]: General Requirements. (b)(3) A copy of the waste analysis plan required by 264.13(b) and, if applicable, 264.13(c).	The need for TSDFs to submit a WAP as part of a permit application is discussed generally in this manual.
(4) <i>Compliance with feedrate limits</i> . To comply with the applicable feedrate limits of this section, you must monitor and record feedrates as follows: (i) Determine and record the value of the parameter for each feedstream by sampling and analysis or other method; (ii) Determine and record the mass or volume flowrate of each feedstream by a CMS. If you determine flowrate of a feedstream by volume, you must determine and record the density of the feedstream by sampling and analysis (unless you report the constituent concentration in units of weight per unit volume (e.g., mg/l)); and (iii) Calculate and record the mass feedrate of the parameter per unit time.	40 CFR 264.341 (b) Throughout normal operation the owner or operator must conduct sufficient waste analysis to verify that waste feed to the incinerator is within the physical and chemical composition limits specified in his permit (under 264.345(b)). 40 CFR 266.102 Permit standards for burners. (b) Hazardous Waste Analysis (2) Throughout normal operation, the owner or operator must conduct sampling and analysis as necessary to ensure that the hazardous waste, other fuels, and industrial furnace feedstocks fired into the boiler or industrial furnace are within the physical and chemical composition limits specified in the permit.	2.12 Recordkeeping

APPENDIX E: Glossary of Terms

Captive TSDF: A TSDF that receives hazardous wastes only from generators within its own corporation. Such generators could be located on the same site as the captive TSDF or off-site.

Certification: A written statement of professional opinion and intent signed by an authorized representative that acknowledges an owner's or operator's compliance with the applicable LDR requirements. Certifications are required for treatment in surface impoundment exemption requests, applications for case-by-case extensions to an effective date, no-migration petitions, and waste analysis and recordkeeping provisions applicable to any person who generates, treats, stores, or disposes of hazardous wastes (excluding generators that do not treat on site and send waste off site to be treated). The information referenced by the certification must be true, accurate, and complete. There may be significant penalties for submitting false information, including fines and imprisonment.

Commercial TSDF: A TSDF engaged in the conduct of commercial (i.e., for-profit) waste management that receives hazardous wastes generated by other companies. Such companies are normally located off-site.

Disposal Facility: A facility or part of a facility at which hazardous waste is intentionally placed into or on any land or water, and at which waste will remain after closure. The term disposal facility does not include a corrective action management unit into which remediation wastes are placed.

Facility: All contiguous land, structures, or other appurtenances, and improvements on the land, used for treating, storing, or disposing of hazardous waste. A facility may consist of one or several treatment, storage, or disposal operational units (e.g., one or more landfills, surface impoundments, or combinations of them).

Fingerprint Analysis: Sampling and analysis of several key chemical and physical parameters of a waste to substantiate or verify the composition of a waste as determined previously during a full-scale waste characterization. Fingerprint analysis is typically used by generators and off-site TSDFs to expedite waste characterization of frequently generated or received wastes. Parameters for analysis may be a subset of the parameters used during full-scale characterization, or they may be parameters that are not normally present in the waste to verify the absence of certain constituents.

Generator: Any person, by site, whose act or process produces hazardous waste identified or listed in Part 261 of RCRA or whose act first causes a hazardous waste to become subject to regulation.

Hazardous and Solid Waste Amendments (HSWA): Amendments to RCRA in 1984, that minimize the nation's reliance on land disposal of hazardous waste by, among other things,

requiring EPA to evaluate all listed and characteristic hazardous wastes according to a strict schedule to determine which wastes should be restricted from land disposal.

Hazardous Waste: Per RCRA Section 1004, waste that, because of its quantity, concentration, or physical, chemical, or infectious characteristics, may cause or significantly contribute to an increase in mortality or an increase in serious irreversible, or incapacitating reversible, illness, or pose a substantial present or potential hazard to human health or the environment when improperly treated, stored, transported, or disposed of, or otherwise managed. Per 40 CFR Part 260.10, hazardous wastes are defined in §261.3, which includes listed wastes and/or wastes that exhibit one of the four characteristics (i.e., ignitability, corrosivity, reactivity, and toxicity).

Hazardous Waste Code: The number assigned by EPA to each hazardous waste listed in 40 CFR Part 261, Subpart D, and characteristic waste identified in 40 CFR Part 261, Subpart C.

Interim Status: A facility that can operate without a RCRA Subtitle C permit provided 1) the facility was in existence on November 19, 1980; 2) the facility is in existence on the effective date of a new regulation that lists a waste as a hazardous waste or establishes a new characteristic of hazardous waste; or 3) the facility is in existence on the effective date of a new regulation that regulates a hazardous waste management unit for the first time. In both circumstances, Part A of the permit application must be submitted to EPA by a specified date (with Part B submitted voluntarily or “called in” by EPA at a subsequent date). The intent of interim status is to allow a facility to continue to operate for an interim period pending approval of their permit application.

Lab Pack: A lab pack is an over packed container, usually a steel, fiber, or polyethylene drum, containing small containers of chemicals of the same hazardous class packed in non-biodegradable absorbent materials.

Land Disposal Restrictions: Provision of HSWA that prohibits the land disposal of hazardous wastes, unless EPA finds that it will not endanger human health and the environment. EPA must develop levels or methods of treatment that substantially diminish the toxicity of the waste or the likelihood that hazardous constituents will migrate from the waste that must be met before the waste is land disposed. Strict statutory deadlines were imposed on EPA to regulate the land disposal of specific hazardous wastes, concentrating first on the most harmful.

Notification: In the context of the LDR program, when restricted wastes are being shipped off-site for treatment, storage, disposal, or are managed on-site, EPA has established a tracking system that requires that notifications and certifications be sent to the receiving facility or if applicable to EPA or the appropriate EPA representative. These requirements are outlined in 40 CFR §268.7. For example, notification requirements include the EPA Hazardous Waste Number, corresponding treatment standards or prohibition levels, the manifest number, and waste analysis data.

Off-Site Facility: A facility that receives and manages hazardous waste from another facility that is not geographically on site.

On-Site Facility: A facility that manages only those hazardous wastes that are generated on its own geographic site.

Prohibited Wastes: Prohibited wastes are a subset of restricted wastes (under the LDR regulations) that have established treatment standards but do not meet the respective treatment standards, nor have a variance or waiver in effect and are, therefore, ineligible for land disposal.

RCRA Subtitle C Permit: An authorization via a permit from EPA that allows a facility to treat, store, and/or dispose of hazardous wastes. The permit includes administrative requirements and facility operating and technical standards for each type of waste management unit that is being permitted. [Facility owners/operators must submit a two-part (Part A and Part B) permit application to obtain a RCRA Subtitle C permit.]

Resource Conservation and Recovery Act (RCRA): The Resource Conservation and Recovery Act of 1976 (which amended the Solid Waste Disposal Act of 1965) regulates both hazardous wastes and non-hazardous wastes. RCRA has been amended three times, most significantly, on November 8, 1984. The 1984 amendments known as the Hazardous and Solid Waste Amendments (HSWA) significantly expanded the scope and requirements of RCRA.

Restricted Wastes: Restricted wastes are those RCRA hazardous wastes that are subject to the LDR program. A waste is restricted if EPA has established a treatment standard for it, or if it has been specifically designated by Congress as ineligible for land disposal. While some restricted wastes may be eligible for land disposal without meeting treatment standards, all restricted wastes are, at a minimum, subject to the waste analysis, notification, and recordkeeping requirements of 40 CFR §268.7.

State Director: A term used in the RCRA regulations to denote the state hazardous waste agency.

Storage Facility: A facility that holds hazardous waste for a temporary period, at the end of which the hazardous waste is treated, disposed of, or stored elsewhere.

Subtitle C Facility: A facility that manages hazardous wastes as defined by RCRA. These facilities may include disposal facilities (e.g., landfills, surface impoundments), treatment facilities, (e.g., incinerators) and storage facilities.

Subtitle D Facility: A facility that manages non-hazardous wastes as defined by RCRA. These facilities may include disposal facilities (e.g., landfills), treatment facilities (e.g., incinerators), and storage facilities.

Toxicity Characteristic Leaching Procedure (TCLP): A method to determine the mobility of both organic and inorganic contaminants in liquids, solids, and multiphase wastes.

Transporter: A person engaged in the off-site transportation of hazardous waste by air, rail, highway, or water.

Treatment Facility: A facility that uses any method, technique, or process, including neutralization, designed to change the physical, chemical, or biological character or

composition of any hazardous waste so as to neutralize such waste, or to render such waste either non-hazardous or less hazardous; safer to transport, store, or dispose of; or amenable for recovery, amenable for storage, or reduced in volume.

Waste Analysis: Obtaining a detailed chemical and physical analysis of a representative sample of a waste. The analysis may include data developed using sampling and analysis, as well as existing published or documented data on the waste or waste generated from similar processes. Use of the phrase “waste analysis” refers to both waste testing and applying acceptable knowledge

Waste Analysis Plan (WAP): Document describing the procedures that will be carried out at a facility to meet waste analysis requirements.

DRAFT

APPENDIX F: Key Considerations and Tips

Key Considerations for Waste Analysis Plans

- WAPs are not one-size-fits-all; a WAP that is appropriate for a commercial treatment/storage/disposal facility may not be appropriate for treatment/disposal facilities, or even captive storage facilities.
- Do not clutter up the WAP by repeating information that exists elsewhere in the permit (e.g., basic facility description, process descriptions).
- Prepare procedures for subjecting all wastes to the same level of analysis, not just hazardous wastes.
- Focus on up-front waste profiling; this is especially important for “back-end treatment/disposal facilities.
- Include some amount of off-site independent laboratory analysis. It is important to conduct waste testing as opposed to relying solely on just generator acceptable knowledge. Procure a laboratory with a state laboratory certification program or other reputable third-party accreditation. It is very difficult for a TSDF to maintain an adequate on-site lab.
- Include electronic records management tools used by the facility, [e.g., Excel spreadsheets (for TSDFs) and custom software programs (for generators who are allowed to perform statistical analysis of homogeneous wastestreams and are allowed to exclude outliers)].
- Recommend that all wastes received are subject to some level of waste analysis not just those received as “hazardous waste.”
- Specify the test methods (SW-846, ASTM, or other) to be used to test for each parameter, in accordance with 40 CFR §264.13(b)(2).
- Include sampling protocols for different containers and transport vehicles (e.g., drums and tankers) and different materials or phase-separated wastestreams.
- Recommend the facility perform a “discrepancy review” when the waste acceptance testing shows a certain percentage variance (trigger level to be negotiated with the permit writer) from the waste profile data (e.g., for BTU value discrepancy, require a discrepancy review if the BTU value varies by more than 15%).
- Provide documentation for discrepancies and resolution (e.g., rejected load or modified profile) in the facility operating record. Provide documentation of any unusual conditions

that occur after the waste has passed acceptance criteria and waste is accepted into the facility (e.g., a tank farm).

Key Considerations for the Permitting Agency and Inspectors

- Become familiar with the facility; schedule a visit.
- Use clear, enforceable language when preparing permit conditions and require the same from the facility in their permit application (e.g., use “must” and “shall” as opposed to “may” or “should”).
- Consider including a permit condition that requires notification of any changes to the WAP or deviation from a test method.
- Include a permit condition requiring notification of any changes to the WAP or significant deviation from a test method.
- Maintain a generic permit template that includes all federal/state conditions. Keep it up-to-date.
- During inspections, or compliance evaluations consider using someone on-staff (Agency or Agency contractor) with a chemistry or laboratory background to evaluate WAP compliance.

Key Considerations for Generators

- Learn your legal responsibilities under RCRA and your state’s hazardous waste program by reviewing your state’s generator standards and guidance.
- Speak with the personnel at your site and compile paperwork to develop a collective knowledge of your generating processes, potential wastes, regulatory requirements, and opportunities for waste minimization.
- Contact your state agency, or the agency in the TSDF’s state, if you have questions (e.g., should the analyses be performed by certified laboratory?).
- If you do not have the expertise at your facility, consider using a qualified consultant or TSDF for assistance in identifying, collecting, and characterizing your waste
- Ensure that the implementation of the WAP will avoid mixing of incompatible wastes and placing wastes in incompatible accumulation tanks/containers.
- Obtain representative samples for unlisted wastes; that is, a sample of a universal or whole (e.g., waste pile, lagoon) waste which can be expected to exhibit the average properties’ of the universe or whole.
- Include procedures for obtaining/maintaining documentation sufficient to support waste/acceptable knowledge determinations in lieu of testing (i.e., process knowledge, records of analyses or combination of these with actual chemical analysis of the waste).

- Support any claims that secondary materials are NOT solid and/or hazardous waste with documentation.
- It's important to not rely on a single analysis to characterize subsequent wastestreams. Waste-derived residues should be sampled as often as necessary for the owner/operator to determine whether the residue is excluded or fully regulated hazardous waste. All waste-derived residue generated since the previous successful analysis could be viewed as fully regulated absent documentation demonstrating otherwise.
- Make sure you determine what constitutes a new point of generation especially considering applicability of new underlying hazardous constituents (UHCs).
- Use appropriate methods and avoid undocumented methods.
- Be aware of what happens if the waste contains Appendix VIII constituents but does not meet the definition of a hazardous waste.
- Be aware of the need to characterize your waste more frequently if the process that generates the waste changes.
- Remember that thermal treatment by generators is prohibited except in select units.
- Make sure you adequately address your process description in the WAP when using acceptable knowledge especially if it relates to characterizing F- and K- listed wastes.

Tips for RCRA Inspectors to Evaluate Facility Compliance with Waste Analysis Plans

- Before inspecting the TSDF, familiarize yourself with the facility's permit and operations generally, including the WAP. Develop a facility-specific inspection plan and questions to ask the facility when on-site. Perform database searches and review available facility records, such as Biennial Reporting data on the types and quantities of wastes received on-site. Reviewing these reporting data may indicate particular challenges that the facility may encounter when implementing their WAP (e.g., you may notice that some generators are submitting highly variable wastes that could require frequent re-characterization). During your inspections, be sure to ask questions about these challenges.
- During the inspection, speak with the individual(s) authorized by the TSDF to be responsible for ensuring compliance with the WAP (e.g., facility manager or designee) to get an overview of the facility's experiences using the WAP (e.g., problems, concerns, questions). This conversation could occur, for example, during the opening meeting. Follow up on possible violations, problems, and questions raised. Ask questions about key processes and procedures in the WAP to ensure the procedures are correctly followed and that the WAP is up-to-date.
- Ask questions about the pre-qualification process to ensure the facility is evaluating new wastestreams adequately. For example, if generic profiles are being used, are they used

only in appropriate situations (e.g., generic profiles are not appropriate for wastes that must meet numerical limits, such as feed streams into combustion units).

- Request the SOPs for some of the sampling analysis being performed by the facility (e.g., pH tests) and determine if they are being followed. This can be accomplished, for example, by observing facility personnel in the conduct of their job responsibilities (e.g., during sampling of drums of an incoming shipment) or by briefly interviewing laboratory personnel to evaluate their understanding of these procedures. (See below for additional tips on laboratories).
- Ask the facility how often it has found discrepancies between incoming shipments and waste profiles, and review relevant records. In these cases, did the TSDF identify the causes and implement appropriate corrective actions to prevent recurrence? Were new or revised waste profiles developed in all cases? Ask treaters and disposers how often they test their treated wastes for LDR compliance (e.g., each batch)? For wastes that have failed to meet applicable LDR standards, what were the causes (e.g., is there a pattern of failures suggesting a common cause?) and what corrective actions were taken to prevent their recurrence?
- Review the facility's training records of key personnel (e.g., environmental technicians) to verify that they are given frequent training on relevant knowledge and skills related to waste sampling and analysis. Interview facility personnel and observe them performing their job functions to evaluate their knowledge and skills (e.g., ask for facility workers to demonstrate how to properly sample a drum using a coliwasa; ask him when a grab vs. composite sample is required for wastes managed under this authority).
- For on-site laboratories at a generator or TSDF:
 - Ask for a split sample of waste (e.g., a waste that has been treated to meet LDR standards) to be sent to an independent laboratory that is trusted by EPA to verify the on-site laboratory's results.
 - Make certain that it has the required instrumentation (e.g., does it have a Pensky-Martin flashpoint apparatus if that method is how it reports flashpoint and is it maintained?) and a trained operator can explain its use. pH is often not correctly understood or performed for solid and semisolid waste, so reviewing those procedures can be enlightening regarding the actual level of understanding of the technicians assigned to these tasks.
 - Review the laboratory's certificate of accreditation (if the state requires laboratory accreditation) to make certain that it has achieved and maintained accreditation in the parameters it is testing. State accreditation programs universally require that accredited laboratories participate in external performance evaluation programs. Ask to see records of the evaluations.
- Consider bringing a chemist or related expert to the inspection to review laboratory results (or otherwise, copy analytical records and take them for later review). For

example, the chemist could review a sample of laboratory results to verify that the analytical methods used were appropriate and the detection limits were sensitive enough to evaluate compliance with applicable numerical limits.

DRAFT

APPENDIX G: References

A Method for Determining the Compatibility of Hazardous Wastes, [EPA-600/2-80-076](#), U.S. Environmental Protection Agency, Cincinnati, Ohio, 1980. 149 pp.

Burning of Hazardous Waste in Burners and Industrial Furnaces. [Federal Register 56:166 \(27 August 1991\). p. 42509](#). Retroactive Hazardous Waste Designation.

Calculating Upper Confidence Limits for Exposure Point Concentrations at Hazardous Waste Sites, U.S. Environmental Protection Agency, [OSWER 9285.6-10](#), December 2002.

Characterizing Heterogeneous Wastes: Methods and Recommendations. U.S. Environmental Protection Agency, ORD, U.S. Department of Energy, [EPA 600-R-92-033](#), February 1992.

Clean Water Act [Analytical Methods](#).

Criteria for the Certification and Recertification of the Waste Isolation Pilot Plant's Compliance With the Disposal Regulations. [Federal Register 67:154 \(9 August 2002\) p. 51942](#). Acceptable Knowledge Definition.

Design and Development of a Hazardous Waste Reactivity Testing Protocol. [EPA-600/52-84-057](#), U.S. Environmental Protection Agency, Municipal Environmental Research Laboratory, Cincinnati, Ohio, 1984.

Guidance Manual for Hazardous Waste Incinerator Permits. [SW-966](#), U.S. Environmental Protection Agency, Washington, D.C., 1983.

Guidance of Systematic Planning Using the Data Quality Objectives Process, [EPA240-B-06-001](#), U.S. Environmental Protection Agency, Washington, D.C., February 2006.

Hazardous Waste Management System. [Federal Register 55:27 \(8 February 1990\) pps. 4443-4444](#). Representative Sample Definition.

Hazardous Waste Treatment, Storage, and Disposal Facilities and Hazardous Waste Generators. [Federal Register 59:233 \(6 December 1994\) p. 62916](#). Examples of Acceptable Knowledge.

Identification and Listing of Hazardous Waste Under RCRA, Subtitle C, Section 3001. Listing of Hazardous Waste (40 CFR §§261.31 and 261.32), [Background Document](#), U.S. Environmental Protection Agency, Washington, D.C., 1980. 855 pp.

Joint NRC/EPA Guidance on Testing Requirements for Mixed Radioactive and Hazardous Waste. [Federal Register 62:224 \(20 November 1997\) pps. 62079-62082](#). Mixed Radioactive and Hazardous Waste and Use of Waste Knowledge for Hazardous Waste Determinations.

Land Disposal Restrictions for Newly Identified and Listed Hazardous Wastes and Hazardous Soil. [Federal Register 58:176 \(14 September 1993\) pps. 48111-48112](#). Demonstrating Acceptable Knowledge.

Land Disposal Restrictions for Second Third Scheduled Wastes. [Federal Register 54:120 \(23 June 1989\) pps. 26605-26606](#). Treatment Standards Based on Single Facility Data and Grab Samples Versus Composite Samples.

Land Disposal Restrictions for Third Third Scheduled Wastes. [Federal Register 55:106 \(1 June 1990\) p. 22539](#). Treatment Standards Based on Single Facility Data, Grab Samples Versus Composite Samples, and Waste Analysis Plans.

Land Disposal Restrictions Phase II--Universal Treatment Standards, and Treatment Standards for Organic Toxicity Characteristic Wastes and Newly Listed Wastes. [Federal Register 59:180 \(19 September 1994\) pps. 48003-48004](#). LDR Lab Packs Phase II.

Land Disposal Restrictions Phase IV: Final Rule Promulgating Treatment Standards for Metal Wastes and Mineral Processing Wastes; Mineral Processing Secondary Materials and Bevill Exclusion Issues; Treatment Standards for Hazardous Soils, and Exclusion of Recycled Wood Preserving Wastewaters. [Federal Register 63:100 \(26 May 1998\) p. 28562](#). Development of New Treatment Standards for Hazardous Wastes Containing Metals: Measuring Compliance by Grab or Composite Sampling.

Land Disposal Restrictions Phase IV: Treatment Standards for Wood Preserving Wastes, Treatment Standards for Metal Wastes, Zinc Micronutrient Fertilizers, Carbamate Treatment Standards, and K088 Treatment Standards. [Federal Register 64:90 \(11 May 1999\) pps. 25411-25412](#). Treatment Residual, New Point of Generation, and UHCs.

[Methods Innovation Rule \(MIR\)](#). U.S. Environmental Protection Agency, Washington, D.C., 2005.

Observational Economy Series, Volume 1: Composite Sampling, U.S. Environmental Protection Agency, Washington, D.C., [EPA 230-R-95-005](#), 1995.

Occupational Safety and Health Guidance Manual for Hazardous Waste Site Activities, U.S. Department of Labor, Occupational Safety & Health Administration, [October 1985](#).

Permit Applicants' Guidance Manual for the [General Facility Standards](#) of 40 CFR §§264. SW-968, U.S. Environmental Protection Agency, Washington, D.C., 1983.

Permit Applicants' Guidance Manual for [Hazardous Waste Land Treatment, Storage, and Disposal Facilities](#). SW-84-004, U.S. Environmental Protection Agency, Washington, D.C., 1983.

RCRA Orientation Manual 2011. U.S. Environmental Protection Agency, Washington, D.C., [EPA 530-F-11-003, 2011](#).

RCRA Waste Management: Planning, Implementation, and Assessment of Sampling Activities, [Manual 42](#), American Society of Testing and Materials, 2000.

RCRA Waste Sampling Draft Technical Guidance, Planning, Implementation and Assessment, [EPA 530-D-02-002, 2002](#).

Revision of Wastewater Treatment Exemptions for Hazardous Waste Mixtures ("Headworks Exemptions"). [Federal Register 70:191 \(4 October 2005\) pps. 57769-57771](#). Headworks Exemptions.

Standard Methods for the Examination of Water and Wastewater, [22nd Edition](#), American Public Health Association (APHA), the American Water Works Association (AWWA), and the Water Environment Federation (WEF), S82210, 2012.

Superfund Program Representative Sampling Guidance, Volume 4: Waste, U.S. Environmental Protection Agency, Washington, D.C., [EPA 540-R-95-141](#), 1995.

Test Methods for Evaluating Solid Waste, Physical/Chemical Methods. [SW-846](#), Third Edition, Through Final Update IVB, U.S. Environmental Protection Agency, Washington, D.C., 2008.